

# EUROCONTROL Specification for the Origination of Aeronautical Data Volume 2: Guidance Material

**EUROCONTROL Specification for the  
Origination of Aeronautical Data  
Volume 2: Guidance Material**

**DOCUMENT IDENTIFIER: EUROCONTROL - SPEC - 154**

<b>Edition Number</b>	:	<b>1.0</b>
<b>Edition Date</b>	:	<b>04/02/2013</b>
<b>Status</b>	:	<b>Released Issue</b>
<b>Intended for</b>	:	<b>General Public</b>
<b>Category</b>	:	<b>EUROCONTROL Specification</b>



## DOCUMENT CHARACTERISTICS

TITLE			
<b>EUROCONTROL Specification for the Origination of Aeronautical Data - Volume 2</b>			
		<b>Publications Reference:</b>	SPEC-154
		<b>ISBN Number:</b>	978-2-87497-070-2
<b>Document Identifier</b>		<b>Edition Number:</b>	1.0
EUROCONTROL-SPEC-154		<b>Edition Date:</b>	04/02/2013
Abstract			
Volume 2 of this EUROCONTROL Specification provides guidance and comprehensive requirements which should be met when originating aeronautical data in order to comply with requirements concerning the quality of aeronautical data and aeronautical information.			
Keywords			
Origination	Specification	Interoperability	DO
SES	AIS	AIM	ADQ
Contact Person(s)		Tel	Unit
Manfred UNTERREINER		+32 2 729 3038	DSS/REG/SES
Miguel RODRIGUES PAULO		+32 2 729 9818	DSS/REG/SES

STATUS, AUDIENCE AND ACCESSIBILITY					
Status		Intended for		Accessible via	
Working Draft	<input type="checkbox"/>	General Public	<input checked="" type="checkbox"/>	Intranet	<input type="checkbox"/>
Draft	<input type="checkbox"/>	EUROCONTROL	<input type="checkbox"/>	Extranet	<input type="checkbox"/>
Proposed Issue	<input type="checkbox"/>	Restricted	<input type="checkbox"/>	Internet (www.eurocontrol.int)	<input checked="" type="checkbox"/>
Released Issue	<input checked="" type="checkbox"/>				

## DOCUMENT APPROVAL

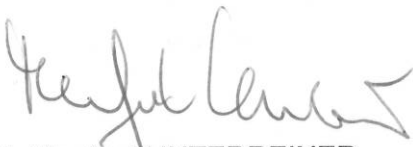
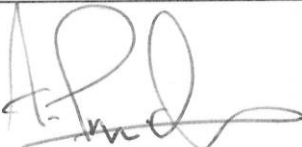
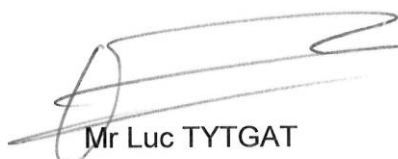
The following table identifies all management authorities who have successively approved the present issue of this document.

AUTHORITY	NAME AND SIGNATURE	DATE
Task Leader	 Mr Manfred UNTERREINER	7/2/2013
Head of SES Unit	 Mr Peter GREEN	7/2/2013
Director Single Sky	 Mr Luc TYTGAT	7/2/2013
On behalf of the Director General by special delegation Principal Director ATM	 Mr Bo REDEBORN	11/2/2013

## DOCUMENT CHANGE RECORD

The following table records the complete history of the successive editions of the present document.

Edition Number	Edition Date	Reason for Change	Pages Affected
1.0	04/02/2013	Released Issue	All

### Publications

EUROCONTROL Headquarters  
96 Rue de la Fusée  
B-1130 BRUSSELS

Tel: +32 (0)2 729 4715

Fax: +32 (0)2 729 5149

E-mail: [publications@eurocontrol.int](mailto:publications@eurocontrol.int)

# CONTENTS

DOCUMENT CHARACTERISTICS .....	ii
DOCUMENT APPROVAL .....	iii
DOCUMENT CHANGE RECORD .....	iv
CONTENTS .....	v
1 Introduction .....	1
1.1 Background.....	1
1.2 Purpose and Scope .....	1
1.3 Conventions.....	1
1.4 Document Structure.....	3
1.5 Referenced Documents.....	3
1.5.1 Description of References .....	3
1.5.2 Primary References.....	3
1.5.3 Associated References.....	4
1.6 Abbreviations .....	5
2 Specification for Data Origination Requirements .....	9
2.1 General Requirements.....	9
2.1.1 Data Quality.....	9
2.1.2 Reference System Specification.....	9
2.1.3 Data Product Specifications .....	12
2.1.4 Specific Categories of Data .....	13
2.1.5 Data Processing .....	16
2.1.6 Data Exchange .....	16
2.1.7 Data Validation and Verification .....	17
2.2 Survey .....	17
2.2.1 Facilities and Corresponding Minimum Data Requirements .....	17
2.2.2 Handling of Data.....	18
2.2.3 Data Maintenance .....	18
2.2.4 General Requirements and Survey Principles.....	19
2.2.5 Geodetic Control Network .....	20
2.2.6 Survey Requirements for Facilities.....	23
2.2.7 Survey Data Processing .....	30
2.2.8 Quality Assurance .....	31
2.2.9 Survey Report Requirements .....	31

---

2.2.10	Training and Qualification .....	32
2.3	Instrument Flight Procedure Design .....	32
2.3.1	General.....	32
2.3.2	Training and Qualification of Designers.....	33
2.3.3	Validation and Verification of Instrument Flight Procedures.....	34
2.3.4	Flight Validation.....	34
2.3.5	Flight Inspection .....	35
2.3.6	Quality Records.....	36
2.4	Airspace and ATS Route Planning .....	36
2.4.1	General.....	36
2.4.2	Quality Records.....	37
Annex A	CONFIGURATION CONTROL .....	38
Annex B	HORIZONTAL REFERENCE SYSTEMS.....	39
Annex C	VERTICAL REFERENCE SYSTEMS .....	47
Annex D	MONUMENTATION .....	51
Annex E	DESCRIPTION OF AIRPORT FACILITIES .....	56
Annex F	DESCRIPTION OF HELIPORT FACILITIES .....	76
Annex G	SURVEY PROCEDURES.....	80
Annex H	SPECIFICATION UPDATE PROCEDURES.....	93

## LIST OF FIGURES

Figure 1: Geoid Undulations with Respect to an Ellipsoid .....	48
--	----

## LIST OF TABLES

Table 1: Tolerance Values (Multipliers) for Aeronautical Data.....	17
Table 2: Geometric Constants .....	40
Table 3: Some of WGS-84 Ellipsoid Derived Geometric Constants .....	40
Table 4: Continental Drift Expressed in Different ITRF Epochs .....	42

# 1 Introduction

## 1.1 Background

As part of the WGS-84 implementation programme, EUROCONTROL developed guidance for surveyors which addressed how a survey should be undertaken in the field of aviation. Specific information relating to typical aviation equipment was provided, such that the surveyor knew which part of the equipment needed to be measured.

This guidance was offered to the International Civil Aviation Organisation (ICAO) for consideration and formed the basis of ICAO Doc 9674 – The WGS-84 Manual [RD 27]. Whilst this manual was updated in 2002, it has remained largely unchanged since.

Survey techniques and capabilities have, and continue to, advance at a fast rate. In addition, current and future flight operations are more reliant on data that is of sufficient quality.

In January 2010, the European Commission published the Commission Regulation (EU) 73/2010 (ADQ) laying down requirements on the quality of aeronautical data and aeronautical information for the single European sky. The need for a specification on the origination of aeronautical data was identified in the final mandate report supporting this regulation.

As a result, EUROCONTROL developed this specification, the EUROCONTROL Specification for the Origination of Aeronautical Data, which brings guidance through Volume 2 up-to-date. Consequently, organisations may wish to use this document in preference to the WGS-84 Manual [RD 27].

This Specification has been developed and is presented in two volumes:

- Volume 1 provides compliance material in the form of specific requirements (also included in Volume 2) which must be met, as a minimum, to be compliant with the identified Articles of Commission Regulation (EU) 73/2010;
- Volume 2 provides guidance and comprehensive requirements complementing Volume 1.

Note: The guidance developed for survey has been based upon the assumption that surveyors already have an understanding of how to survey and the material presented herein explains how to apply that knowledge in the aviation domain. As such, the terminology used is appropriate for the survey community and may not be so familiar to stakeholders from other disciplines.

## 1.2 Purpose and Scope

Volume 2 of this EUROCONTROL Specification provides guidance and comprehensive requirements, stemming from different recognised sources, which should be met when originating aeronautical data in order to comply with requirements concerning the quality of aeronautical data and aeronautical information.

The scope of data and functional coverage in this document is similar to Volume 1, however, the scope of source documents used to produce Volume 2 is much wider which can be generally identified from the list of primary references indicated in 1.5.2.

Note: Volume 1 of this EUROCONTROL Specification identifies a sub-set of requirements (also included in Volume 2 as “shall”) which must be met, as a minimum, to be compliant with the identified Articles of Commission Regulation (EU) 73/2010. Relationship of key requirements contained in both Volumes is ensured through a consistent requirement numbering method.

## 1.3 Conventions

A minimum subset of requirements necessary for the correct and harmonised origination of aeronautical data is specified. In addition, a number of recommendations are also made. Requirements (mandatory) within the EUROCONTROL Specification are clearly distinguished from recommendations / best practice, optional requirements and informative text.



This distinction is applied through the application of terminology. Conventions for denoting requirements, recommendations and optional requirements are as follows:

- ‘Shall’ - indicates a statement of specification, the compliance with which is mandatory to achieve the implementation of this EUROCONTROL Specification. It indicates a requirement which must be satisfied by all parties claiming conformity to this EUROCONTROL Specification (those are the requirements which form part of the possible MoC covered in Volume 1). Such requirements shall be testable and their implementation auditable.
- ‘Must’ - indicates a statement of specification, the compliance with which is mandatory to achieve compliance with ICAO Standards. Such requirements shall be testable and their implementation auditable.
- ‘Should’ - indicates a recommendation or best practice, which may or may not be satisfied by all parties claiming conformity to this Specification.
- ‘May’ – indicates an optional element.

It should be noted that some requirements necessitate the compliance, in full or in part, with specific ICAO Annexes to the Chicago Convention. Where such reference is made, this should be interpreted as a requirement to comply with the Standards contained within the referenced material only. There is no intention that Recommended Practices are mandated. Further, where a State has notified a difference to ICAO in regards to the specified ICAO Standards, due regard should be given to those differences when assessing compliance.

Every requirement and recommendation in this EUROCONTROL Specification is followed by a structured identifier, which can be used to uniquely reference the requirement/recommendation from associated documents and traceability tools. Such identifiers have the form:

DO-[Fn]-[nnnn]

where:

[Fn]: is a sequence of characters to identify the functional area to which the requirement applies, e.g. “FPD” for requirements related to instrument flight procedure design;

[nnnn]: is a numeric identifier for a sequence of requirements within the same functional area<sup>1</sup>.

The functional areas are:

- RDQ: Requirements for Data Quality;
- REF: Reference System Specification;
- UOM: Units of Measurement;
- DPS: Data Product Specification;
- CAT: Categories of Data;
- PRO: Data Processing
- VAL: Validation and Verification;
- SVY: Survey;

---

<sup>1</sup> Note that the requirement numbers are initially allocated incrementally in tens. This aids the subsequent management of this specification allowing new requirements to be inserted between existing requirements whilst maintaining a logical number sequence.

- FPD: Instrument Flight Procedure Design;
- ASD: Airspace Design.

Any text which does not contain one of the terms 'shall', 'should' or 'may' and which does not have a requirement number associated with it is provided as information only.

Within this document the phrase "National Administration" is used to indicate the body responsible for the establishment of aviation policy within a State.

## **1.4 Document Structure**

This EUROCONTROL Specification comprises a 'Main Body', providing introductory and explanatory material and a chapter providing detailed requirements for the harmonised origination of data. It is supported by a number of Annexes providing additional material.

This EUROCONTROL Specification comprises the following Chapters and Annexes:

- Chapter 1 includes introductory material relating to this EUROCONTROL Specification.
- Chapter 2 provides the requirements for data origination.
- Annex A provides the configuration control record for the specification.
- Annex B provides guidance on horizontal reference systems.
- Annex C provides guidance on vertical reference systems.
- Annex D provides guidance on monumentation for survey.
- Annex E provides a description of airport facilities.
- Annex F provides a description of heliport facilities.
- Annex G provides guidance on survey procedures.
- Annex H provides the specification update procedures.

## **1.5 Referenced Documents**

### **1.5.1 Description of References**

This EUROCONTROL Specification incorporates, by reference, a number of specifications and standards maintained by other bodies.

Primary references are those referred to in the requirements of this EUROCONTROL Specification, and which parts thereof constitute an integral part of this EUROCONTROL Specification.

Associated references are those standards and other documents that are referenced from recommendations or explanatory material and are not, therefore, essential for implementation.

Reference documents are indicated throughout the specification with RD followed by the number listed below.

### **1.5.2 Primary References**

- [RD 1] EUROCONTROL Terrain and Obstacle Data Manual, Draft 1.0, May 2010.

- [RD 2] EUROCONTROL ASM.ET1.ST03.4000.EAPM.02.02 Airspace Planning Manual.
- [RD 3] ICAO Convention on International Civil Aviation, Annex 5 – Units of Measurement to be Used in Air and Ground Operations, 5<sup>th</sup> edition, July 2010.
- [RD 4] ICAO Convention on International Civil Aviation, Annex 6 – Operations of Aircraft, Part 1 - International Commercial Air Transport — Aeroplanes, 9<sup>th</sup> Edition, July 2010, Amendment 35, October 2011.
- [RD 5] ICAO Convention on International Civil Aviation, Annex 10 — Aeronautical Telecommunications. Volume I (Radio Navigation Aids), 6<sup>th</sup> edition, July 2006, Amendment 87, July 2012.
- [RD 6] ICAO Convention on International Civil Aviation, Annex 11 — Air Traffic Service, 13<sup>th</sup> edition, July 2001, Amendment 48, November 2010.
- [RD 7] ICAO Convention on International Civil Aviation, Annex 14 — Aerodromes. Volume I - Aerodrome Design and Operations, 5<sup>th</sup> edition, July 2009.
- [RD 8] ICAO Convention on International Civil Aviation, Annex 14 — Volume II - Heliports, 3<sup>rd</sup> edition, July 2009.
- [RD 9] ICAO Convention on International Civil Aviation, Annex 15 — Aeronautical Information Services, 13<sup>th</sup> Edition, July 2010.
- [RD 10] ICAO Doc 4444 – Procedure for Air Navigation Services: Air Traffic Management, 15<sup>th</sup> edition, 2007, Amendment 3, November 2010.
- [RD 11] ICAO Doc 7910 – Location Indicators, 141<sup>st</sup> edition, September 2011.
- [RD 12] ICAO Doc 8168 - Procedures for Air Navigation Services, Volume II – Aircraft Operations, 5<sup>th</sup> edition, Amendment 4, November 2010.
- [RD 13] ICAO Doc 8400 - ICAO Abbreviations and Codes, 8<sup>th</sup> edition, 2010.
- [RD 14] ICAO Doc 9368 - Instrument Flight Procedures Construction Manual, 2<sup>nd</sup> edition, 2002.
- [RD 15] ICAO Doc 9426 — Air Traffic Services Planning Manual, 1<sup>st</sup> (provisional) edition, 1984, Amendment 4.
- [RD 16] ICAO Doc 9613 – Performance-based Navigation (PBN) Manual, 3<sup>rd</sup> edition, 2008.
- [RD 17] ICAO Doc 9689 — Manual on Airspace Planning Methodology for the Determination of Separation Minima, 1<sup>st</sup> edition, 1998, Amendment 1, August 2008.
- [RD 18] ICAO Doc 9905 — Required Navigation Performance Authorization Required (RNP AR) Procedure Design Manual, 1<sup>st</sup> edition, 2009.
- [RD 19] ICAO Circular 120 - Methodology for the Derivation of Separation Minima Applied to the Spacing between Parallel Tracks in ATS Route Structures.
- [RD 20] ISO 19111:2007 — Geographic information -- Spatial referencing by coordinates.
- [RD 21] ISO 19114:2003 — Geographic information -- Quality evaluation procedures.
- [RD 22] ISO 19115:2003 — Geographic information – Metadata.

### 1.5.3 Associated References

- [RD 23] Directive 2007/2/EC of the European Parliament and of the Council of 14 March 2007 establishing an Infrastructure for Spatial Information in the European Community (INSPIRE).
- [RD 24] EUROCAE ED-99 C /DO-272 - User Requirements for Aerodrome Mapping Information, September 2011.

- [RD 25] ICAO Doc 8071 – Manual on Testing of Radio Navigation Aids, Volume I, 4<sup>th</sup> edition, 2000, Amendment 1, October 2002.
- [RD 26] ICAO Doc 8071 – Manual on Testing of Radio Navigation Aids, Volume II, 5<sup>th</sup> edition, 2007.
- [RD 27] ICAO Doc 9674 - World Geodetic System — 1984 (WGS-84) Manual, 2<sup>nd</sup> edition, 2002.
- [RD 28] ICAO Doc 9906 – The Quality Assurance Manual for Flight Procedure Design, 1<sup>st</sup> edition, 2009.
- [RD 29] Joint Committee for Guides in Metrology (JCGM 100:2008 Evaluation of measurement data — Guide to the expression of uncertainty in measurement (GUM1995 with minor corrections).
- [RD 30] National Imaging and Mapping Agency TR8350.2 - Department of Defense, World Geodetic System 1984, 3<sup>rd</sup> Edition, Amendment 1, 2000.
- [RD 31] EUROCONTROL Guidelines for P-RNAV Infrastructure Assessment, Edition 1.2, dated 16/04/2008 (EUROCONTROL-GUID-0114).

## 1.6 Abbreviations

AGL	Above Ground Level
AIP	Aeronautical Information Publication
AIS	Aeronautical Information Services
AISP	Aeronautical Information Service Provider
ALS	Airborne Laser Scanning
AMDB	Aerodrome Mapping Database
ANSP	Air Navigation Service Provider
ASCII	American Standard Code for Information Interchange
ASD	Airspace Design
ASDA	Accelerate-Stop Distance Available
ATM	Air Traffic Management
ATS	Air Traffic Services
BIH	Bureau International de l'Heure
CAT	Categories of Data
CDDIS	Crustal Dynamics Data Information Service
CRS	Co-ordinate Reference System
DGNSS	Differential GNSS
DGPS	Differential Global Positioning System
DME	Distance Measuring Equipment
DOP	Dilution of Precision
DPS	Data Product Specification
DSM	Digital Surface Model
DTM	Digital Terrain Model
EGM	Earth Gravitational Model

EGNOS	European Geostationary Navigation Overlay Service
ENPRM	EUROCONTROL Notice of Proposed Rule Making
EPN	EUREF Permanent Network
ERAF	EUROCONTROL Regulatory and Advisory Framework
ETRF	European Terrestrial Reference Frame
ETRS	European Terrestrial Reference System
EU	European Union
EUROCAE	European Organisation for Civil Aviation Equipment
EUROCONTROL	European Organisation for the Safety of Air Navigation
EVRF	European Vertical Reference Frame
EVRS	European Vertical Reference System
FAS	Final Approach Segment
FATO	Final Approach and Take-off
FIR	Flight Information Region
FL	Flight Level
FMS	Flight Management System
FPD	Instrument Flight Procedure Design
Ft	Feet
GBAS	Ground-Based Augmentation System
GNSS	Global Navigation Satellite System
GPS	Global Positioning System
GRS	Geodetic Reference System
GSFC	Goddard Space Flight Center
IAG	International Association of Geodesy
ICAO	International Civil Aviation Organisation
ICARD	ICAO International Codes and Route Designators
IERS	International Earth Rotation and Reference Systems Service
IGS	International GNSS Service
ILS	Instrument Landing System
IMU	Inertial Measuring Unit
INSPIRE	Infrastructure for Spatial Information in Europe
IRM	IERS Reference Meridian
IRP	IERS Reference Pole
ISO	International Organisation for Standardisation
ITRF	International Terrestrial Reference Frame
ITRS	International Terrestrial Reference System
KGNSS	Kinematic GNSS

km	Kilometres
LDA	Landing Distance Available
MLS	Microwave Landing System
MSL	Mean Sea Level
NAP	Normaal Amsterdams Peils
NASA	National Aeronautics and Space Administration
NIMA	National Imagery and Mapping Agency
NM	Nautical Miles
NOAA	National Oceanic and Atmospheric Administration
ODCS	Obstacle Data Collection Surface
ORCAM	Originating Region Code Assignment Method
PBN	Performance-based Navigation
POS	Positioning and Orientation System
PPP	Precise Point Positioning
PRO	Data Processing
RDQ	Requirements for Data Quality
REF	Reference System Specification
RGNSS	Relative GNSS
RINEX	Receiver Independent Exchange Format
RNAV	Area Navigation
RNP	Required Navigation Performance
RNP AR	Required Navigation Performance Authorization Required
RTK	Real-time Kinematic
SAAM	System for Traffic Assignment & Analysis at Macroscopic Level
SARPs	Standards and Recommended Practices
SDG	Specification Drafting Group
SID	Standard Instrument Departure
SOPAC	Scripps Orbit and Permanent Array Center
SSR	Secondary Surveillance Radar
STAR	Standard Terminal Arrival Route
SVY	Survey
TLOF	Touchdown and Lift-off Area
TODA	Takeoff Distance Available
TORA	Takeoff Run Available
UOM	Units of Measurement
UTC	Co-ordinated Universal Time
UTM	Universal Transverse Mercator

VAL	Validation and Verification
VOR	VHF Omnidirectional Radio Range
WGS-84	World Geodetic System-1984

## 2 Specification for Data Origination Requirements

The conventions for denoting requirements, recommendations and optional requirements in this Chapter are detailed in Section 1.3.

It should be noted that to improve readability, document references are not provided in this chapter. However, all documents referred to within this section are listed in Chapter 1.5.

### 2.1 General Requirements

#### 2.1.1 Data Quality

##### 2.1.1.1 General

**[DO-RDQ-010]** All data shall be originated in a manner which meets identified data quality requirements for that data item.

Note<sub>(1)</sub>: Each data item to be originated should have defined data quality requirements that specify, as a minimum:

- the accuracy and resolution of the data;
- the integrity level of the data;
- the confidence that the data provided meets the requirements of the data user in terms of accuracy;
- resolution and integrity.

Note<sub>(2)</sub>: For all data items, the ability to determine the origin of the data and to ensure that it is made available to the next intended user prior to its effective start date/time and not deleted before its effective end date/time should also be considered as data quality requirements.

#### 2.1.2 Reference System Specification

##### 2.1.2.1 Horizontal Reference System

**[DO-REF-010]** The horizontal reference system for the publication of all co-ordinate data shall be the World Geodetic System-1984 (WGS-84).

Note<sub>(1)</sub>: Access to WGS-84 has historically been difficult to realise with centimetre accuracy. However, the WGS-84 co-ordinate system is aligned with the International Terrestrial Reference System (ITRS), realised through the International Terrestrial Reference Frame (ITRF) at a defined epoch. ICAO Annex 15 [RD 9] identifies the ITRF 2000 specification (i.e. frame ITRF 2000, at epoch January 01, 2000) as the appropriate epoch, where ITRF is used, for the determination of horizontal co-ordinates.

Note<sub>(2)</sub>: Further explanation and guidance is provided in Annex B. The terms WGS-84 and ITRF are used synonymously in this EUROCONTROL Specification. For this practical reason, the term ITRF 2000 is predominantly used in the document (although ICAO Annex 15 [RD 9] uses the term WGS-84 for historical reasons).

Note<sub>(3)</sub>: The Infrastructure for Spatial Information in Europe (INSPIRE) directive<sup>2</sup> requires that the European Terrestrial Reference System 1989 (ETRS89)

---

<sup>2</sup> Commission Regulation (EU) No 1089/2010 of 23 November 2010 implementing Directive 2007/2/EC [RD 23].



*shall* be the datum used for spatial data sets. Within the geographical scope of ETRS89, the use of ETRS89 as the datum for the aviation domain should be considered for data storage and to transform data to ITRF for publication. For practical reasons associated with the densification of European Terrestrial Reference Frame 1989 (ETRF89), a survey relative to ETRF89 is often easier than to ITRF. Since appropriate transformations are available, the quality of the data is not expected to be impacted by this approach.

**[DO-REF-020]** If aeronautical data items have been surveyed in a different ITRF version to ITRF 2000, or in any other reference frame, the appropriate ITRF transformation should be applied to the data for publication to produce co-ordinates in a world-wide, consistent reference frame (WGS-84 / ITRF 2000).

**[DO-REF-030]** If aeronautical data items have been surveyed in a different ITRF version to ITRF 2000, or in any other reference frame, it should be ensured that the data items are stored only in the reference frame in which they were originated.

Note<sub>(1)</sub>: The storage of data in the reference frame in which they were originated avoids the possibility that data is transformed from one reference to another and then to a third where accuracy may be lost through multiple transformations.

Note<sub>(2)</sub>: For some data items, publication in more than one horizontal reference system may be required. In such cases, it is recommended that all publication data is derived from a single data source (i.e. from the one in which the co-ordinates are stored).

**[DO-REF-040]** If data that has been transformed from one reference frame to another is stored, the original data item should also be stored with it as metadata, along with details of the reference frame used for origination.

**[DO-REF-050]** The reference system used in data origination should be a dynamic terrestrial reference frame which is connected to ITRF via transformation parameters.

**[DO-REF-060]** The version of the horizontal reference frame used shall be recorded as metadata<sup>3</sup> at the level of the data item.

**[DO-REF-070]** The horizontal reference frame used in data origination shall be recorded, together with the co-ordinates, as (lineage) metadata.

**[DO-REF-080]** When it can be ensured that all data items in a data set are originated in an identical horizontal reference frame and version (epoch), the horizontal reference frame used in the data origination may be recorded at the data set level as (lineage) metadata.

### 2.1.2.2 Vertical Reference System

**[DO-REF-090]** All surveyed vertical aeronautical data points shall be expressed as a height relative<sup>4</sup> to Mean Sea Level (MSL).

Note: For the documentation of the vertical distances between a point and the MSL, the term 'elevation' is used in aviation.

---

<sup>3</sup> More information on metadata and quality reporting can be found in section 2.2.8.3.

<sup>4</sup> Heights referenced to MSL may be expressed as above MSL or below MSL. Although the abbreviation AMSL (for above MSL) is often referred to, it is not used by ICAO and is, therefore, not recognised as a reference within this specification.

**[DO-REF-100]** A geoid model sufficient to meet the ICAO requirements shall be used to determine the MSL reference surface.

**[DO-REF-110]** Earth Gravitational Model (EGM) 1996 (EGM-96) must be used as the global gravity model for the publication of vertical information.

Note<sub>(1)</sub>: In many States, geoid models with higher accuracy than EGM-96 are available. For practical reasons, the origination of vertical information is usually based on local elevation systems. Where the local elevation system is based on a geoid or quasi-geoid, the transformation between such local elevation and EGM-96 is usually given and allows the accuracy to be maintained. Where the local vertical reference system is not based on a geoid, it is recommended that the origination of elevation information is referenced to the EGM-96 geoid.

Note<sub>(2)</sub>: Annex C provides further information on vertical reference systems and issues related to the determination of geoid undulations.

**[DO-REF-120]** Where a geoid model other than the Earth Gravitational Model (EGM) 1996 (EGM-96) is used, the geoid model should be made available in compliance with the International Organisation for Standardisation's (ISO) 19111:2007 "Geographic information -- Spatial referencing by coordinates" [RD 20].

Note: One possible implementation of "making available" is to provide a raster data set where, for each cell, the geoid undulation value is provided.

**[DO-REF-130]** Where a non-global geoid model (i.e. other than EGM-96) is based on a different horizontal reference system than WGS-84, the position of the geoid undulation values should also be transformed to WGS-84.

**[DO-REF-140]** If aeronautical data items have been originated using a different geoid model than EGM-96, it should be ensured that the data items are stored only in the vertical reference system in which they are originated.

Note: For some data items, publication in more than one vertical reference system may be required. In such cases, it is recommended that all publication data is derived from a single data source (i.e. from the one in which the co-ordinates are stored).

**[DO-REF-150]** The information about the geoid model used for the expression of elevations shall be recorded, together with the elevation value, as (lineage) metadata at the level of the data item.

**[DO-REF-160]** When it can be ensured that all data items in a data set are originated in an identical vertical reference system, the reference system used in data origination may be recorded at the data set level as (lineage) metadata.

**[DO-REF-170]** Where a different geoid model than EGM-96 is used, the reference to the originator of the model should be recorded in the metadata.

### **2.1.2.3 Temporal Reference System**

**[DO-REF-180]** The temporal reference system used for aeronautical data shall be the Gregorian calendar and Co-ordinated Universal Time (UTC), in accordance with ICAO Annex 15 [RD 9].

### **2.1.2.4 Units of Measurement**

**[DO-UOM-010]** The units of measurement in which data is provided must be in accordance with ICAO Annex 5 [RD 9].

**[DO-UOM-020]** For all numerical data, the unit of measurement shall be recorded as metadata.

**[DO-UOM-030]** Positions should be recorded in the form of sexagesimal degrees (Degrees Minutes Seconds and decimals of a Second) to the resolutions required to meet the defined data quality requirements for the data item.

**[DO-UOM-040]** Bearings, azimuths and magnetic variations should be recorded in the form of decimal degrees (Degrees and decimals of a Degree) to the resolutions required to meet the defined data quality requirements for the data item.

**[DO-UOM-050]** Dimensions and distances must be recorded in one of the following units:

- a) Metres (m);
- b) Feet (ft);
- c) Kilometres (km);
- d) Nautical Miles (NM).

**[DO-UOM-060]** The primary unit for distances over 4,000 metres must be kilometres.

**[DO-UOM-070]** As an alternative to the primary unit for distances over 4,000 metres, nautical miles may be used.

**[DO-UOM-080]** The primary unit for elevations, altitudes and heights must be metres.

**[DO-UOM-090]** As an alternative to the primary units for elevations, altitudes and heights, feet may be used.

**[DO-UOM-100]** In accordance with ICAO, all elevation, altitudes and heights should be expressed in relation to one of the following references:

- a) MSL,
- b) Above Ground Level (AGL), or
- c) Flight Level (FL).

### 2.1.3 Data Product Specifications

**[DO-DPS-010]** The party requesting the origination, modification or withdrawal of data shall clearly specify the data and the action to be applied to it by means of a Data Product Specification.

**[DO-DPS-020]** The Data Product Specification shall:

- a) clearly identify the entity to which the data must be provided;
- b) clearly identify the report format to be used<sup>5</sup>;
- c) include the data quality requirements.

**[DO-DPS-030]** The data originator shall originate, modify or withdraw data in accordance with the Data Product Specification.

**[DO-DPS-040]** The data originator shall ensure that when data with a data integrity level of critical is originated, modified or withdrawn, it is independently<sup>6</sup> verified to confirm that the origination has been conducted in accordance with the Data Product Specification.

**[DO-DPS-050]** The data originator shall record the actions carried out in order to originate, modify or withdraw the data in accordance with the Data Product Specification as metadata.

---

<sup>5</sup> The report format to be used may be included as part of the DPS or reference made to the specification of a report format available through other documentation.

<sup>6</sup> Independence means that the verification should be undertaken either by separate personnel or a separate system process to that which performed the origination.

**[DO-DPS-060]** The request for origination should be stored as part of the metadata for the resultant data.

Note: The recording of the request for origination as metadata is needed to support later validation and verification activities.

**[DO-DPS-070]** The party requesting the origination, modification or withdrawal of data shall verify that the data originator has correctly implemented the Data Product Specification.

## 2.1.4 Specific Categories of Data

### 2.1.4.1 Magnetic Variation

Magnetic Variation is the term used in aeronautical navigation to define the difference between True North and Magnetic North.

**[DO-CAT-010]** Magnetic variation should be determined by the national geodetic agency derived from an appropriate geomagnetic model, such as the International Geomagnetic Reference Field<sup>7</sup>.

**[DO-CAT-020]** The date of measurement and the annual rate of change of magnetic variation must be provided.

**[DO-CAT-030]** Station declination should be provided by the service provider responsible for the Navaid.

Note: The Station Declination is the difference between True North and the VHF Omnidirectional Radio Range (VOR) North Alignment and, unless the VOR has been aligned to True North, should not exceed 1.5° of the current Magnetic Variation.

### 2.1.4.2 Calculated and Derived Data

#### 2.1.4.2.1 Source Data

**[DO-CAT-040]** Co-ordinate data not determined by survey shall either be:

- a) Calculated using geodesic algorithms and source data that has been defined in WGS-84. For example:
  - A bearing and distance from a point;
  - The intersection of bearings from two points;
  - The intersection of distances from three points.
- b) Derived from source data that has been defined in WGS-84. For example:
  - Manually selected points along a line of longitude or latitude;
  - Manually selected points determined “by definition”<sup>8</sup>.

**[DO-CAT-050]** The methods(s) employed to calculate or derive data shall be recorded as metadata.

**[DO-CAT-060]** Before a data item is calculated/derived, it shall be ensured that the quality of the input data used is sufficient to achieve the required quality of the output data.

Note<sub>(1)</sub>: Unless otherwise indicated, the required accuracy is indicated by the number of significant figures used in calculated/declared data. The

---

<sup>7</sup> See [www.ngdc.noaa.gov/geomagmodels/Declination.jsp](http://www.ngdc.noaa.gov/geomagmodels/Declination.jsp). Please note that the National Oceanic and Atmospheric Administration (NOAA) uses the term “declination” in place of “variation”.

<sup>8</sup> Typical examples for such objects are restricted airspaces or danger areas.

accuracy requirements of calculated data are achieved by performing all intermediate calculations with the maximum possible resolution (but at least 10 times better) and only rounding the final result.

Note<sup>(2)</sup>: The document 'Guide to the Expression of Uncertainty in Measurement' (JCGM 100:2008) [RD 29] provides material on how to determine the uncertainty of calculated and derived data.

**[DO-CAT-070]** Conversions of distances and angular units must be performed in accordance with ICAO Annex 5 [RD 3].

Note: An example of such an action is the conversion of metres to feet.

**[DO-CAT-080]** Distance and length data should be determined either by distance measurement or by calculation.

**[DO-CAT-090]** Distance and length values should be geodesic distances<sup>9</sup>, i.e. the shortest distance between any two points on a mathematically defined ellipsoidal surface.

Note: The geodesic distance between two points is often referred to as great circle (orthodrome).

**[DO-CAT-100]** Bearing data should be calculated using geodesic algorithms and source data that has been defined in WGS-84.

**[DO-CAT-110]** Elevation/height/altitude data should be:

- a) Determined by geodetic survey (see section 2.2) or;
- b) Determined by analysis of a suitable digital terrain model (see also Appendix C.2.5) or;
- c) Calculated by adding specified values (e.g. Minimum Obstacle Clearance) to data determined in a) to b) above<sup>10</sup> or;
- d) Specified by airspace designers, taking account of minimum altitudes/flight levels determined in a) to c) above.

**[DO-CAT-120]** Derived data shall be validated using appropriate means.

**[DO-CAT-130]** The method used to validate the calculated or derived data shall be documented.

#### 2.1.4.2.2 Specific Cases

**[DO-CAT-140]** The co-ordinates of the Global Navigation Satellite System (GNSS) service area should be provided by the GNSS service supplier, where applicable.

**[DO-CAT-150]** The co-ordinates and vertical extents of Prohibited, Restricted and Danger Areas should be provided by the authority responsible for the area.

#### 2.1.4.3 Naming / Identification

##### 2.1.4.3.1 Generic

Naming and identification normally follow conventions established either at a global level by ICAO, by regional bodies, such as EUROCONTROL, or at a national level. Such conventions determine, for example, the number of letters that should be used and the alphanumeric characters that may be used. Details of particular naming conventions are found below.

##### 2.1.4.3.2 Specific

---

<sup>9</sup> For a definition of "geodesic distance", see ICAO Annex 15, Chapter 2.

<sup>10</sup> For example, procedure design.

**[DO-CAT-160]** The identifier for Prohibited, Restricted and Danger Areas should be allocated by a single national authority.

**[DO-CAT-170]** Objects that are surveyed should be associated with a unique identifier.

Note<sub>(1)</sub>: Following survey, it may be identified that an object has penetrated one or more defined surfaces and is therefore considered as being of relevance to aviation as an obstacle.

Note<sub>(2)</sub>: The EUROCONTROL Terrain and Obstacle Manual provides guidance on the identification of obstacles [RD 1].

**[DO-CAT-180]** Radio navigation aids must be identified in accordance with ICAO Annex 10 Volume I [RD 5] and designated in accordance with ICAO Annex 11, Appendix 2 [RD 6].

**[DO-CAT-190]** GNSS elements approved for operational use must be identified in accordance with ICAO Annex 10 Volume I [RD 5].

**[DO-CAT-200]** Significant points must be identified in accordance with ICAO Annex 11, Appendix 2 [RD 6].

**[DO-CAT-210]** All current aerodrome and heliport location indicators and names must be recorded in ICAO Doc 7910 [RD 11].

Note<sub>(1)</sub>: The State body responsible for the allocation of aerodrome location indicators is required to make a proposal to ICAO through the ICAO International Codes and Route Designators (ICARD) service for a new aerodrome location indicator where that aerodrome is used internationally, in accordance with ICAO's working instructions. However, it is recommended that this process is applied for all aerodromes, irrespective of their international / domestic status. ICAO has the ultimate responsibility for the approval of a new aerodrome location indicator.

Note<sub>(2)</sub>: There is no agreed heliport indicator naming scheme.

**[DO-CAT-220]** Runway designations must meet the requirements of ICAO Annex 14 Volume I [RD 7].

**[DO-CAT-230]** Airspaces must be identified in accordance with ICAO Annex 11 [RD 6].

**[DO-CAT-240]** All Air Traffic Services (ATS) routes, other than Standard Instrument Departures (SIDs) and Standard Terminal Arrival Routes (STARs), must be identified in accordance with ICAO Annex 11, Appendix I [RD 6].

**[DO-CAT-250]** All SIDs and STARs must be identified in accordance with ICAO Annex 11, Appendix 3 [RD 6].

#### 2.1.4.4 Textual Elements

**[DO-CAT-260]** Textual elements should be developed to be clear and unambiguous and understandable to users considering that the language used may not be the first language of the user.

**[DO-CAT-270]** Irrespective of the associated data integrity level, all textual elements should be independently reviewed.

##### 2.1.4.4.1 Translation

**[DO-CAT-280]** Any translation of text from one language to another should be undertaken by staff with a suitable level of competence.

Note<sub>(1)</sub>: The level of competence needed to support the translation tasks needed should be identified in the competence management framework needed as part of the organisation's Quality Management System.

Note<sub>(2)</sub>: Ideally, translation should be performed by a translator whose mother tongue is the target language of the translation.

Note<sub>(3)</sub>: Names should be transliterated from a non-Roman alphabet form by the system generally used by the State.

**[DO-CAT-290]** When the data conveyed in a translation includes data classified with an integrity level of critical, the translation should be independently reviewed.

#### **2.1.4.5 Abbreviations**

**[DO-CAT-300]** Abbreviations must be in accordance with ICAO Abbreviations and Codes (PANS-ABC (Doc 8400)) [RD 13].

**[DO-CAT-310]** Where other abbreviations are used, these must be clearly explained and listed in the National Aeronautical Information Publication (AIP).

#### **2.1.4.6 Radar Services and Procedures**

**[DO-CAT-320]** Relevant communication failure procedures should be developed.

**[DO-CAT-330]** Communication failure procedures must be in accordance with ICAO Annex 6 Part 1 [RD 4] and ICAO Doc 4444 [RD 10].

**[DO-CAT-340]** The origination of Secondary Surveillance Radar (SSR) code allocation blocks should be co-ordinated with the Originating Region Code Assignment Method (ORCAM) Users Group.

#### **2.1.4.7 Aerodrome Noise Abatement Procedures**

**[DO-CAT-350]** Aerodrome noise abatement procedures should be developed with the involvement of the aerodrome, National Administration and any environmental agencies determined by the State.

#### **2.1.4.8 Withdrawn Data**

**[DO-CAT-360]** Data which is no longer effective should not be permanently removed from storage but marked as withdrawn and retained for a minimum of five years.

#### **2.1.5 Data Processing**

**[DO-PRO-010]** Any processing of aeronautical data/information shall be conducted in a manner that ensures that the accuracy and resolution are maintained and that the data quality requirements are achieved.

#### **2.1.6 Data Exchange**

**[DO-EXC-010]** A data exchange format should be agreed for the provision of data to Aeronautical Information Service Providers (AISPs).

**[DO-EXC-020]** Where possible, the data exchange format for the provision of data to the Aeronautical Information Service (AIS) should utilise the same format as that used by the AIS to make digital data sets of aeronautical data/information available to the next intended user.

Note: For data providers other than Air Navigation Service Providers (ANSPs), it may not be possible to comply with this requirement.

**[DO-EXC-030]** The means and format for data exchange shall be documented in the formal arrangements established between the sending and receiving party.

### 2.1.7 Data Validation and Verification

**[DO-VAL-010]** Data validation and verification processes shall be adequate for the assigned integrity level of the data item.

**[DO-VAL-020]** Prior to use in deriving or calculating other data, aeronautical data/information shall be validated and verified.

## 2.2 Survey

### 2.2.1 Facilities and Corresponding Minimum Data Requirements

**[DO-SVY-010]** The spatial accuracy of an individual data item should not be worse than the tolerance values.

Note<sub>(1)</sub>: The tolerance value can be used to determine the maximum allowed deviation from a real-world item (co-ordinate or elevation) to its measured value. The maximum deviation is calculated as "*max = ± tolerance \* accuracy requirement*".

Note<sub>(2)</sub>: The accuracy requirements published in the ICAO Standards and Recommended Practices (SARPs) are based on either a 90% or a 95% confidence level. The confidence level expresses the probability that any single data item in the data set is in error of the true value by less than the stated accuracy.

Note<sub>(3)</sub>: Where single observations are made (mass data like obstacles), an independent quality control is usually applied to state the accuracy and confidence level. If in an independent quality control for a data set the calculated standard deviation meets the defined confidence level (for example 95%), the data set passes the test. Nevertheless, in such a test, the accuracy of a single item may show a gross error (such as 15m when 3m is required). The table below proposes tolerances which should not be exceeded. For mass data origination, such as for obstacles, terrain or runway features, such a tolerance matrix may be helpful to the surveyor.

Note<sub>(4)</sub>: The table below provides recommends tolerance values for 90% and 95% confidence levels<sup>11</sup>.

Confidence	Routine	Essential	Critical
90%	3.5	3	(no such data)
95%	3	2	(always redundant measurements)

**Table 1: Tolerance Values (Multipliers) for Aeronautical Data**

**[DO-SVY-020]** The survey method for the origination of a feature's co-ordinate shall be capable of meeting the data quality requirements.

**[DO-SVY-030]** The survey method for the origination of a feature's co-ordinate shall be validated to ensure that it is capable of meeting the data quality requirements.

<sup>11</sup> By example, for an Area 2 obstacle (Integrity: routine, 90% confidence, 3m accuracy) the tolerance is ± 3\*3.5m = ±10.5m.



**[DO-SVY-040]** Organisations should follow best practice guidelines in Annex G to this EUROCONTROL Specification.

### 2.2.1.1 Calibration of Survey Equipment

**[DO-SVY-050]** All survey equipment deployed in relation to surveys covered by this EUROCONTROL Specification shall be shown to be calibrated<sup>12</sup> and to perform to the accuracy appropriate to the task.

**[DO-SVY-060]** Sensor calibration instructions shall be based on the requirements of the survey method and the sensor manufacturer's requirements.

**[DO-SVY-070]** A radiometric calibration of a sensor system should be considered when surveying obstacles from an airborne or space-borne sensor platform.

**[DO-SVY-080]** Equipment calibration shall be shown to be valid for the time of use.

**[DO-SVY-090]** Details of the calibration process and results shall be included in the survey report.

### 2.2.2 Handling of Data

**[DO-SVY-100]** Reference point co-ordinates shall be loaded into the survey equipment by digital data transfer.

**[DO-SVY-110]** The reference points utilised in survey equipment should be evaluated for the correct epoch before being loaded.

Note: The term "correct" refers to the requirement for the reference points, permanent reference network (if available) and publication epoch to be aligned.

**[DO-SVY-120]** The data originator shall ensure that the measurements in the field are digitally captured and stored.

**[DO-SVY-130]** Where information, such as lever arm or tripod height, cannot be measured by digital sensors, the surveyor shall provide evidence that such information is not affected by a gross error.

Note: Independent redundant measurements of the information or check surveys of known points are considered an effective means to detect gross errors.

**[DO-SVY-140]** The use of a specific data model for aviation features in the sensor software should be considered.

### 2.2.3 Data Maintenance

**[DO-SVY-150]** Surveyed, calculated and derived data shall be maintained throughout the lifetime of each data item and for at least five years following the end of that period or until five years after the end of the period of validity for any data item calculated or derived from it, whichever is the latter.

**[DO-SVY-160]** Surveyors shall digitally capture and store observations (raw data, etc), parameters and intermediate data.

**[DO-SVY-170]** All information (parameter, intermediate results, etc) and records (survey report including data quality evaluation, metadata, etc) related to a surveyed, calculated or derived aeronautical data item shall be maintained with the data item throughout the lifetime of the data item.

---

<sup>12</sup> The calibration of survey equipment is undertaken in accordance with the manufacturer of the equipment and by organisations authorised by it.

Note: Only that metadata required to comply with the formal arrangements, established between the surveyor and the requesting authority, need be provided.

**[DO-SVY-180]** All survey data assigned a data integrity level of critical or essential shall be monitored for changes on a yearly basis, as a minimum.

Note: Monitoring ensures that a survey item has not been shifted, for example, due to construction work. This monitoring should identify survey errors not detectable by single measurement or to confirm the measurements and the quality attributes. The type of monitoring applied may depend on the location of the data and how easily a change may be detected within it. For example, visual inspection may be sufficient or resurvey may be considered necessary.

**[DO-SVY-190]** All survey data assigned a data integrity level of routine should be monitored for changes every five years, as a minimum.

Note: Effective notification procedures can help reduce the workload for monitoring the changes to obstacles not situated at or around an aerodrome. The type of monitoring applied may depend on the location of the data and how easily a change may be detected within it. For example, visual inspection may be sufficient or resurvey may be considered necessary.

**[DO-SVY-200]** Monitoring and maintaining co-ordinate data should include a review of the difference between the latest ITRF version required by ICAO and the reference frame used in the original survey.

**[DO-SVY-210]** Where the positional accuracy expressed as a combined uncertainty of measurements exceeds the accuracy requirement for that co-ordinate, re-survey (recalculation) of the relevant data shall be undertaken.

Note: The document 'Guide to the Expression of Uncertainty in Measurement' (JCGM 100:2008) [RD 29] provides material on how to determine the uncertainty of a measurement.

**[DO-SVY-220]** Each State should determine its own requirements for the frequency at which data items are completely re-surveyed.

#### **2.2.4 General Requirements and Survey Principles**

**[DO-SVY-230]** Where co-ordinates in a local co-ordinate frame which meet the data quality requirements are converted to ITRF mathematically, the conversion process shall be shown to be such that the required data quality requirements are maintained.

**[DO-SVY-240]** Survey accuracies shall be such that the uncertainties of each observation are sufficiently small that the data quality requirements are met.

Note: It should be taken into account that the positional quality may be degraded in subsequent processes.

**[DO-SVY-250]** Additional observations may be made to increase the reliability of the measurement.

**[DO-SVY-260]** The reliability of the origination of co-ordinate data, taking into account the survey method, the survey set-up and environmental conditions, shall be sufficient to meet the data quality requirements.

**[DO-SVY-270]** All survey observations should be made and recorded with the resolution and accuracy of the equipment used, so that future requirements for surveys of greater accuracy may be met.

**[DO-SVY-280]** All survey data assigned a data integrity level of critical shall be subject to sufficient additional measurement to identify survey errors not detectable by single measurement.

**[DO-SVY-290]** Additional measurements should be as independent as possible, for example, using a different set-up, sensor or operator.

**[DO-SVY-300]** Where it is operationally beneficial to work in a local (planar) co-ordinate system, evidence shall be given that the transformation to and from the local co-ordinate system does not impact the accuracy.

**[DO-SVY-310]** When a planar co-ordinate system is used in the data origination or data processing, it should be based on ETRF, such as the Universal Transverse Mercator (UTM).

Note: Other planar co-ordinate systems to UTM may also be used in data origination and data processing. It is recommended that such systems are directly linked to ETRF or ITRF.

**[DO-SVY-320]** When a planar co-ordinate system is used, all projection parameters for the co-ordinate system shall be recorded in the metadata associated with the originated co-ordinates to allow unambiguous reconstruction of the projection.

**[DO-SVY-330]** Any additional observations, such as weather (barometric pressure, temperature and wind, etc), should be recorded in the metadata.

Note: There are a number of factors that influence survey accuracy that may be useful in investigating errors that are introduced at the point of survey. This requirement is used to ensure that any such factors are recorded to assist in any root-cause analysis performed.

**[DO-SVY-340]** The surveying organisation shall contact the requesting authority if it requires any clarification about any of the facilities to be surveyed<sup>13</sup>.

## 2.2.5 Geodetic Control Network

### 2.2.5.1 General Requirements

**[DO-SVY-350]** When a geodetic control network exists which meets the requirements listed in sections 2.2.5.1 and 2.2.5.2, it should be used.

Note<sub>(1)</sub>: A geodetic network is built up using survey control stations. For many cases, existing networks of *permanent reference stations*, such as the EUREF Permanent Network (EPN) (see also Annex B) or national permanent GNSS networks can be used as geodetic networks. For airport surveys, a local geodetic control network may exist and can be used for local surveys.

Note<sub>(2)</sub>: The high quality and integrity of permanent GNSS networks should allow the origination of data items to the quality required by the aviation domain. Nevertheless, this integrity may be corrupted by signal interference or mal-operation and should always undergo the appropriated verification.

**[DO-SVY-360]** Where no geodetic network exists which allows the accurate and reliable<sup>14</sup> geodetic connection to ITRF, or the geodetic network is not appropriate for the application and techniques proposed, a network of survey control stations shall be established.

---

<sup>13</sup> Details of aerodrome and heliport facilities that typically require survey can be found in Annex E and Annex F of this EUROCONTROL Specification.

<sup>14</sup> The term reliability is related to integrity and often subdivided into two categories. Internal reliability is a measure of the probability of outliers or biases of a specified size remaining undetected, and external reliability is a measure of the impact of any such biases or outliers on the co-ordinates.

**[DO-SVY-370]** The geodetic control network should consist of a minimum of four survey control stations in order to provide sufficient redundancy.

Note: The origination of terrain and obstacle data in difficult topography or in densely populated areas may require more survey control stations.

**[DO-SVY-380]** Survey control stations<sup>15</sup> should be strategically located so as to provide maximum stability and maximum utility in subsequent surveys.

Note: The monuments of existing aerodrome/heliport geodetic control networks may be used for the purposes laid down in this EUROCONTROL Specification.

### 2.2.5.2 Geodetic Control Network Quality Requirements

**[DO-SVY-390]** The most stringent process requirements (data validation, digital data transfer, metadata, etc) should be considered for survey control stations.

Note: Where a State has National Geodetic Control Networks which provide services for Real-time Kinematic (RTK) measurements, the use of such a service may be used to support data origination.

**[DO-SVY-400]** Survey control stations should fulfil the following data quality requirements:

- 1) Positional accuracy with respect to ITRF: 0.10m;
- 2) Vertical accuracy: 0.05m;
- 3) Confidence Level 95%;
- 4) Integrity:  $1 \times 10^{-8}$  (critical);
- 5) Positional resolution 1/1000sec;
- 6) Vertical resolution: 1cm.

Note: These data quality requirements are derived from the data quality requirements of runway thresholds. The accuracy of survey control stations should be three times higher than the features to be surveyed in order to support their accuracy requirements.

**[DO-SVY-410]** The geodetic control network should have an internal relative precision (accuracy) of better than 0.05m<sup>16</sup>.

**[DO-SVY-420]** The distance between the survey control stations and the items to be surveyed shall ensure that the combined uncertainties of measurement (i.e. the predicted spatial accuracy) do not conflict with the accuracy requirement of the item to be surveyed.

**[DO-SVY-430]** The positions of the non-permanent<sup>17</sup> survey control stations shall be monitored for changes annually, by visual inspection.

**[DO-SVY-440]** Where changes in the positions of the survey control stations are detected, these shall be re-surveyed prior to their use in conducting a survey.

---

<sup>15</sup> Survey control stations are points whose location is known with a high degree of accuracy and which may be used to support the conduct of surveys to derive the position of other points.

<sup>16</sup> The accuracy is usually assessed through precision, which is a measure of the internal consistency of data. Precision and accuracy will be identical when co-ordinates are free of the effects of any biases and outliers in the data.

<sup>17</sup> For the differentiation between permanent (national) geodetic networks and specific local networks, see note to paragraph DO-SVY-350.

**[DO-SVY-450]** The validation of the survey control stations should be based on internal vectors (between the survey control stations) or between survey control stations and national or international control stations.

**[DO-SVY-460]** If the newly computed value of a survey control station's position has changed by 50mm or more when compared to the published value, then the station's position should be re-measured and verified according to the standards laid down in this EUROCONTROL Specification.

### **2.2.5.3 Monumentation of Survey Control Stations**

#### **2.2.5.3.1 Station Construction**

**[DO-SVY-470]** Survey control stations should be made permanently stable by using a monumentation appropriate to the location and the ground beneath it.

**[DO-SVY-480]** The survey control stations should consist of standard types of survey monument (see Annex B).

Note: Different types of monument will be appropriate for different locations and ground conditions at the aerodrome/heliport. It is for the surveyor, under the guidance of the National Administration, to decide on the most appropriate type.

**[DO-SVY-490]** Investigation should be made prior to the installation of survey control stations to ensure that underground cables and services are not affected by the installation.

**[DO-SVY-500]** Where the geodetic control network consists of fewer than the recommended four survey control stations, station monumentation should be as durable and secure as is practicable.

#### **2.2.5.4 Survey Control Station Numbering**

**[DO-SVY-510]** Each survey control station should carry a unique identifier that does not repeat one that has been previously used.

Note: This will ensure that where a station has been destroyed and subsequently replaced by a new station in approximately the same location, misidentification does not occur.

**[DO-SVY-520]** The physical survey control station labelling and numbering should be such that there is no doubt about the identity of the survey station.

**[DO-SVY-530]** The unique identifier for a survey control station should include the ICAO code for the aerodrome / heliport or Flight Information Region (FIR) for which the geodetic control network is designed (see also Annex D).

#### **2.2.5.5 Station Descriptions**

**[DO-SVY-540]** Comprehensive aerodrome survey control station descriptions should be prepared for easy and accurate identification.

**[DO-SVY-550]** A photograph of the survey control station showing background detail should be included in the description.

**[DO-SVY-560]** The complete survey control station description should be made available in the metadata of the control network.

**[DO-SVY-570]** A small scale aerodrome geodetic control network plan, for example 1:2000, indicating the location of all survey stations and principal topographic features, should be prepared as part of the station description.

### 2.2.5.6 Determination of Control Co-ordinates

**[DO-SVY-580]** Survey measurements shall be taken to connect the aerodrome geodetic control network to the ITRF geodetic frame in such a way that the uncertainties of measurement do not conflict with the accuracy requirement of the control network.

**[DO-SVY-590]** For each control station in the geodetic network, static relative differential GNSS vectors shall be measured for a minimum of two points on an appropriate geodetic network.

**[DO-SVY-600]** Three or more points shall be used for the connection to ITRF.

Note: Observation and post-processing guidelines for these operations are provided in Annex G.

**[DO-SVY-610]** Full details of the connection of the control network to ITRF should be included in the survey report.

### 2.2.5.7 Determination of Local Relationship between the Known Existing Datum and ITRF

Note: It should be noted that the material presented within this specification has been developed such that is not specific to any defined epoch. As such, the requirements presented remain valid in the situation that the either the ICAO or national requirements are amended.

**[DO-SVY-620]** Where existing, relative surveys need to be related to ITRF (e.g. aerodrome obstacle surveys), and the local relationship (difference in latitude, longitude, orientation and scale) between the known, existing datum and ITRF has not been provided by the national geodetic agency, observations shall be taken to determine this.

**[DO-SVY-630]** Evidence shall be provided that the accuracy of the local relationship between the known, existing datum and ITRF is commensurate with the required accuracy of the data to be transformed.

**[DO-SVY-640]** The existing datum and the values and accuracies of the local relationship shall be recorded as metadata.

Note: When determining the local relationship between the known existing datum and ITRF, which ITRF epoch is currently required by ICAO should be analysed as this may change over time.

**[DO-SVY-650]** The transformation parameters from the existing datum to ITRF shall be recorded as metadata.

## 2.2.6 Survey Requirements for Facilities<sup>18</sup>

### 2.2.6.1 Radio Navigation Facilities

**[DO-SVY-660]** For radio navigation facilities the survey reference point shall be located as close as practically possible to the antenna phase centre of the transmitting antenna (for some illustrations refer to Annex E to this Specification).

Note: Accurate coordinates for terrestrial navigation facilities are most important where those facilities are used for Area Navigation (RNAV) positioning, e.g., DME (and to a lesser extent VOR).

**[DO-SVY-670]** For Ground Based Augmentation System (GBAS) ground facilities, the promulgated survey point shall be the GBAS reference point – see illustration in Annex E to this Specification.

---

<sup>18</sup> Aerodrome facilities equate to those in Area 3 and Area 4 (See Annex E).

Note: For promulgation to users the GBAS reference point is used as the functional equivalent to the transmitting antenna location.

**[DO-SVY-680]** The surveying organisation shall contact the requesting authority if it requires any clarification about the facilities described in Annex E.

**[DO-SVY-690]** For collocated VOR/Distance Measuring Equipment (DME) with a separation between antennas of greater than 30 metres, both antennas shall be surveyed.

**[DO-SVY-700]** For collocated VOR/DME with a separation between antennas of 30 metres or less, the position of the DME element shall be taken as the position information of this item.

**[DO-SVY-710]** Where it is not possible to connect directly to ITRF, the method of local connection shall be recorded as metadata.

### 2.2.6.2 Runway Centre Lines and Thresholds<sup>19</sup>

**[DO-SVY-720]** For surveying purposes, the centre line reference point of a runway should be the centre line of the defined landing area on the load-bearing surface.

**[DO-SVY-730]** Where the edge of the runway is irregular, or connected to a taxiway, an appropriate theoretical<sup>20</sup> line should be selected, which best identifies the probable edge of the runway.

Note: The theoretical line should never extend beyond the physical edge of the runway.

**[DO-SVY-740]** Where the thresholds are marked by appropriate threshold markers, then the centre of these, along the extension of the centre line, should be taken as the threshold points<sup>21</sup>.

**[DO-SVY-750]** Where no threshold marker exists, the threshold should be determined by the National Administration.

**[DO-SVY-760]** Where no threshold marker exists, the threshold has not been defined by the National Administration, and there is no other indication of the threshold position, then the centre line of the threshold lights immediately in advance (in the direction of landing) of the threshold paint markings (piano keys) should be taken as the threshold.

**[DO-SVY-770]** Where no threshold marker exists, the threshold has not been defined by the National Administration and there is no threshold marker or threshold lighting, the surveyor shall select an appropriate point for survey, in accordance with Annex E.

**[DO-SVY-780]** Survey witness marks may be installed to enable the threshold survey point to be re-established in the event of re-surfacing, re-painting or for verification purposes.

**[DO-SVY-790]** In addition to the thresholds points, two associated runway centre line points, at a separation of not less than 10% of the runway length, should be surveyed to aid co-linearity testing.

**[DO-SVY-800]** Unless visual inspection or previous surveys indicate that the runway centre line is not a straight line, the surveyor should use the co-linearity to verify the accuracy of the runway threshold co-ordinates.

**[DO-SVY-810]** Where a runway has a threshold at each end, the two thresholds and two further runway centre line points should be surveyed.

---

<sup>19</sup> Note: The following requirements are applicable for initial survey. In the event that markings are repainted in the same location, no re-survey is needed.

<sup>20</sup> See also figure in section E.8.

<sup>21</sup> See also the figures provided in Annex E.

**[DO-SVY-820]** Where it is obvious that the runway centre line is not a straight line, additional points should be measured to ensure the horizontal accuracy of the runway centre line.

**[DO-SVY-830]** The co-linearity should be determined for the group of four points in DO-SVY-810.

**[DO-SVY-840]** The co-linearity testing for straight runways should show that the angular deviation between the two vectors is less than five-hundredths of a degree.

**[DO-SVY-850]** If either co-linearity testing fails or the runway centre line is not a straight line, then a full, independent survey of the threshold points should be performed.

**[DO-SVY-860]** The distance from the surveyed threshold point to the end of the paved surface at the near end of the runway should be determined to an accuracy of 0.1m.

**[DO-SVY-870]** The longitudinal<sup>22</sup> slope(s) of the runway should be determined by surveying all the points along the runway centre line where a slope change occurs.

**[DO-SVY-880]** A representative set of points along the runway centre line should be selected to allow the slope change to be detected.

**[DO-SVY-890]** When any type of clearway is declared, the elevation of the runway at the start of the Takeoff Run Available (TORA) (see section 2.2.6.3) and the elevation of the far end of the clearway or clearway plane, as appropriate, should be used in the calculation of the overall slope of the Takeoff Distance Available (TODA).

### 2.2.6.3 Declared Distances

Aerodrome declared distances constitute the relevant distances for the application of the weight and performance requirements of the Air Navigation (General) Regulations in respect of aeroplanes flying for the purpose of public transport.

- TORA: Takeoff Run Available: This is the length of runway available and suitable for the ground run of an aeroplane taking-off;
- ASDA: Accelerate-Stop Distance Available: This is the length of TORA plus the length of any associated stopway;
- TODA: Takeoff Distance Available: This is the length of TORA plus the length of any associated clearway;
- LDA: Landing Distance Available: This is the length of runway declared available and suitable for the ground landing run of an aeroplane.

**[DO-SVY-900]** The start of the TORA, and, where appropriate, the end of any clearway and/or stopways that exist should be indicated to the surveyor by an authorised representative of the Aerodrome Operator.

**[DO-SVY-910]** The TORA, ASDA, TODA and LDA should be measured for each paved and unpaved runway direction in accordance with the data quality requirements.

**[DO-SVY-920]** The distances should be measured along the centre line of the runway and of any associated stopway and clearway.

**[DO-SVY-930]** The end of the declared TORA, ASDA and LDA, the runway end safety area<sup>23</sup>, and the required strip length and width should be defined.

---

<sup>22</sup> Longitudinal slope means the slope extending in the direction of take-off along the length of the runway.

<sup>23</sup> The runway end safety area (RESA) is an area symmetrical about the extended runway centre line and adjacent to the end of the strip primarily intended to reduce the risk of damage to an aeroplane undershooting or overrunning the runway.



Note: If the particular runway is served by an instrument approach procedure, the strip width to be applied when determining LDA will differ from that required for TORA and ASDA.

#### 2.2.6.4 Derived Threshold Co-ordinates

**[DO-SVY-940]** Where a point has been selected for survey which is not coincident with the runway threshold, but offset along the centre line, then the co-ordinates of the threshold should be determined by the National Administration.

**[DO-SVY-950]** The newly derived threshold co-ordinates should be submitted to the same co-linearity check as specified in Paragraph DO-SVY-800.

#### 2.2.6.5 Taxiway and Stand/Checkpoints

##### 2.2.6.5.1 General

**[DO-SVY-960]** For surveying purposes, the centre (mid-width) of the taxiway centre line marking, apron taxiline marking or the aircraft stand guide line marking should be taken as the reference.

**[DO-SVY-970]** The points of commencement and end of each straight section of taxiways, apron taxilines and aircraft stand point guidance lines markings should be surveyed.

**[DO-SVY-980]** For curved sections of taxiways, apron taxilines and aircraft stand guide line markings, the commencement and end of the curved section centre line should be surveyed, when practicable, together with the position of the centre point of the arc and either its radius or at least two additional points along the curve.

**[DO-SVY-990]** In the case of a compound curve, the centre and radius of each arc and the commencement and end of each of the arcs should be surveyed.

**[DO-SVY-1000]** Where it is impracticable to survey the centre and radius of each arc and the commencement and end of each arc in the field<sup>24</sup>, a series of sequential points should be surveyed along the curved section of the centre line with a maximum arc to chord distance not exceeding 0.25m for taxiways and 0.10 for apron taxilines and aircraft stand guide line markings.

**[DO-SVY-1010]** Sufficient points should be surveyed to achieve the required accuracy along the lines.

**[DO-SVY-1020]** The surveyor should, in processing the data, conduct a graphical inspection of the survey points to ensure co-linearity.

Note: A digital orthophoto<sup>25</sup> can support the validation of curved line features.

##### 2.2.6.5.2 Taxiways

**[DO-SVY-1030]** For the guidance of aircraft entering or exiting the runway for take-off or landing, the point at which the radius of turn, prescribed by the appropriate authority for each taxiway, is tangential to the runway centre line and the point at which that radius of turn joins the taxiway centre line marking at a tangent should be surveyed where practicable.

**[DO-SVY-1040]** Where it is impracticable to survey the point at which the radius of turn<sup>26</sup> is tangential to the runway centre line and the point at which that radius of turn joins the taxiway

---

<sup>24</sup> For example where taxiway is a compound curve.

<sup>25</sup> An orthophoto is an aerial photograph geometrically corrected ("orthorectified") such that the scale is uniform: the photo has the same lack of distortion as a map (Source: Wikipedia).

<sup>26</sup> For example, in cases where the elements are not clearly identifiable.

centre line marking at a tangent, a series of sequential points should be surveyed along the curved section of the centre line of taxiways.

Note<sub>(1)</sub>: The European Organisation for Civil Aviation Equipment (EUROCAE)/RTCA document ED-99/DO-272 "User Requirements for Aerodrome Mapping Information" [RD 24] provides additional guidance on how to survey taxiways;

Note<sub>(2)</sub>: The radius of turn for each taxiway should be prescribed by the appropriate authority.

**[DO-SVY-1050]** Where a taxiway centre line marking is provided on a runway that is part of a standard taxi route, or a taxiway centre line is not coincident with the runway centre line, the following points should be surveyed:

- a) The point on the taxiway marking at which the taxiway enters the runway;
- b) The points at which the taxiway deviates from a straight line;
- c) The intersection of the taxiway centre line marking and boundary of each "block" that has been published as part of the airport movement and guidance control system; and
- d) The point on the taxiway marking at which the taxiway exits the runway.

**[DO-SVY-1060]** In defining taxiways, the following points should be surveyed at the centre of the centre line marking of each taxiway, as appropriate:

- a) Intermediate holding positions and runway holding positions (including those associated with the intersection of a runway with another runway when the former runway is part of a standard taxi route) and for points established for the protection of sensitive areas for radio navigation aids;
- b) Taxiway intersection markings;
- c) Intersection of other taxiways, including taxiways as described in DO-SVY-1050;
- d) Intersection of "blocks" defined for surface movement, guidance and control systems;
- e) Commencement and end of selectable taxiway lighting systems provided as part of the surface movement, guidance and control systems, where different from point d) above; and
- f) At stop bars.

**[DO-SVY-1070]** In defining a helicopter air taxiway, the centre of each air taxiway marker should be surveyed, as appropriate.

### 2.2.6.5.3 Aircraft Standpoints

**[DO-SVY-1080]** In defining the aircraft stands, the following points should be surveyed at the centre of the guide line marking of the aircraft stands, as appropriate:

- a) Taxilane centre lines;
- b) Lead-in line(s);
- c) Turning lines;
- d) Straight section of the turning line;
- e) Nosewheel stopping position;
- f) True heading of the alignment bar; and
- g) Lead-out line(s).

**[DO-SVY-1090]** Where aircraft stands are utilised by more than one aircraft type and different guide line markings exist, a diagram should be prepared by the surveyor showing the arrangement of the markings in use, together with an indication of the points surveyed.

Note: Where stands at an aerodrome/heliport are marked uniformly, only a single diagram need be prepared for those with common marking.

### **2.2.6.6 Navigation Checkpoints**

**[DO-SVY-1100]** For navigation checkpoints used for the validation of navigation systems, the nose wheel stopping position should be surveyed in accordance with 2.2.6.5.3.

### **2.2.6.7 Road Holding Positions**

**[DO-SVY-1110]** In accordance with local requirements, significant points should be surveyed to meet the needs of the surface movement guidance and control system for vehicular traffic on the movement area of the aerodrome.

### **2.2.6.8 All Other Aerodrome/Heliport Navigation Elements**

**[DO-SVY-1120]** For all other aerodrome/heliport navigation elements that require surveying, the geometric centre of the element should be surveyed except where a different specific survey point is standardised for the element.

### **2.2.6.9 Heliport / Helipad Data**

#### **2.2.6.9.1 General**

**[DO-SVY-1130]** Heliport data must be surveyed to meet the requirements of ICAO Annex 14 Volume II [RD 8].

**[DO-SVY-1140]** The heliport elevation must be surveyed.

**[DO-SVY-1150]** The position of the heliport reference point must be surveyed.

#### **2.2.6.9.2 Final Approach and Take-off (FATO)**

**[DO-SVY-1160]** The threshold co-ordinates of the Final Approach and Take-off (FATO) Area must be surveyed.

Note<sub>(1)</sub>: FATO marking or markers may be used.

Note<sub>(2)</sub>: The FATO marking is a rectangular stripe with a length of 9 metres or one-fifth of the size of the FATO area which it defines and a width of 1 metre.

Note<sub>(3)</sub>: The FATO marking is white.

**[DO-SVY-1170]** The centre points on each lateral limit of the FATO must be surveyed.

**[DO-SVY-1180]** Where the centre points are not marked, they must be determined by the corner co-ordinates.

**[DO-SVY-1190]** From the centre points the following information related to the FATO must be derived:

- a) The true bearing;
- b) The length;
- c) The width;
- d) The longitudinal slope.

**[DO-SVY-1200]** Where appropriate, the elevation of each threshold of the FATO must be surveyed.

#### **2.2.6.9.3 Touchdown and Lift-off Area (TLOF)**

**[DO-SVY-1210]** Sufficient co-ordinates of the lateral limits of the Touchdown and Lift-off Area (TLOF) area must be surveyed to enable the calculation of the following features:

- a) The geometric centre;
- b) The dimensions;
- c) The slope;
- d) The elevation.

Note: TLOF marking consists of a continuous white line with a width of at least 30cm.

#### **2.2.6.9.4 Aiming Point Marking**

**[DO-SVY-1220]** Where there is an aiming point marking (see Annex F.5), the geometric centre of the equilateral triangle must be calculated by surveying the three corner points.

Note<sub>(1)</sub>: An aiming point marking is provided at a heliport where it is necessary for a pilot to make an approach to a particular point before proceeding to the touchdown and lift-off area, in accordance with ICAO Annex 14 Volume II [RD 8], 5.2.6.1.

Note<sub>(2)</sub>: The aiming point marking is located within the final approach and take-off area, in accordance with ICAO Annex 14 Volume II [RD 8], 5.2.6.2.

Note<sub>(3)</sub>: The aiming point marking is an equilateral triangle with the bisector of one of the angles aligned with the preferred approach direction in accordance with ICAO Annex 14 Volume II [RD 8], 5.2.6.3.

Note<sub>(4)</sub>: According to Annex 14, an aiming point is not a mandatory requirement.

#### **2.2.6.9.5 Safety Area**

**[DO-SVY-1230]** The corners of the lateral limits of the safety area must be determined by survey to enable the calculation of following features:

- a) The length;
- b) The width.

#### **2.2.6.9.6 Taxiways and Routes**

**[DO-SVY-1240]** The corners of the lateral limits of the ground taxiways, air taxiways and air transit routes must be determined by survey to enable the calculation of the following features:

- a) The width;
- b) The geographical co-ordinates of appropriate centre line points.

#### **2.2.6.9.7 Clearway**

**[DO-SVY-1250]** The length of the clearway must be calculated.

#### **2.2.6.9.8 Stands**

**[DO-SVY-1260]** The geographical co-ordinates of each helicopter stand must be surveyed.

#### **2.2.6.9.9 Distances**

**[DO-SVY-1270]** The TODA must be calculated.

Note: The TODA is the length of the FATO off area plus the length of helicopter clearway (if provided) declared available and suitable for helicopters to complete the take-off.

**[DO-SVY-1280]** The rejected TODA must be calculated.

Note: The rejected TODA is the length of the final approach and take-off area declared available and suitable for performance class 1 helicopters to complete a rejected take-off.

**[DO-SVY-1290]** The landing distance available must be calculated.

Note: The landing distance available is the length of the FATO area plus any additional area declared available and suitable for helicopters to complete the landing manoeuvre from a defined height.

**[DO-SVY-1300]** Where appropriate, the distance from the extremities of the TLOF/FATO to the localiser and glidepath elements of the Instrument Landing System (ILS) must be calculated.

**[DO-SVY-1310]** Where appropriate, the distance from the extremities of the TLOF/FATO to the azimuth and elevation antenna of the Microwave Landing System (MLS) must be calculated.

#### 2.2.6.10 Obstacle Data

**[DO-SVY-1320]** The guidelines provided in the EUROCONTROL Terrain and Obstacle Data Manual [RD 1] should be followed for the origination of obstacle data.

#### 2.2.6.11 Terrain Data

**[DO-SVY-1330]** The guidelines provided in the EUROCONTROL Terrain and Obstacle Data Manual [RD 1] should be followed for the origination of terrain data.

### 2.2.7 Survey Data Processing

**[DO-SVY-1340]** Control station and reference point information shall be digitally transferred and loaded into the survey sensor.

**[DO-SVY-1350]** Raw data shall be digitally transferred and loaded into the post-measurement processing software.

**[DO-SVY-1360]** Parameters used in the data processing and which impact the results of the data processing shall be recorded as metadata.

**[DO-SVY-1370]** Prior to use, parameters used in the transformation or conversion of critical and essential data shall be validated by independent verification.

**[DO-SVY-1380]** Intermediate data, i.e. any intermediate result of data processing which is used for further processing<sup>27</sup>, should be treated as if it were a surveyed data item itself.

**[DO-SVY-1390]** Intermediate data should be validated and verified before the continuation of the data processing.

**[DO-SVY-1400]** For every feature whose co-ordinate, distance/length, elevation/height or angle value cannot be directly measured but can be calculated, the association between the raw data, parameters and intermediate data used in the processing shall be recorded to ensure traceability.

**[DO-SVY-1410]** Where the geometry of features, such as obstacles, is derived by human interaction from base data<sup>28</sup>, it shall be subject to independent verification to identify any errors that may have been introduced.

---

<sup>27</sup> Like the Differential Global Positioning System (DGPS) trajectory of an airborne data acquisition platform.

<sup>28</sup> Base data could be data sets, such as Stereo Imagery, digital Orthophoto, digital surface model, points or a point cloud.

## 2.2.8 Quality Assurance

### 2.2.8.1 General

**[DO-SVY-1420]** Where survey data does not meet the identified data quality requirements or where the conformance with the data quality requirements cannot be proven, the data originator shall ensure that such elements are identified and any deviation reported.

Note: Detailed information about quality evaluation procedures of geographic information and the terminology to be used can be found in ISO 19114:2003 [RD 21].

### 2.2.8.2 Data Quality Evaluation

**[DO-SVY-1430]** All originated data shall be evaluated to ensure that it has met the data quality requirements specified in the request for origination.

**[DO-SVY-1440]** Data shall be processed and evidence of this processing maintained such that its quality can be evaluated and errors identified.

### 2.2.8.3 Quality Reporting

**[DO-SVY-1450]** Results of the data quality evaluation should be reported in accordance with ISO 19114:2003 [RD 21].

**[DO-SVY-1460]** Quantitative quality results shall be reported as metadata in compliance with ISO 19115:2003 [RD 22].

Note: Further information on survey reporting and metadata can be found in section 2.2.9.

**[DO-SVY-1470]** Whenever a conformance quality level has been specified in the requirements, the data quality result shall be compared with it to determine conformance.

**[DO-SVY-1480]** Conformance of the data to its data quality requirement shall be reported as pass/fail information.

## 2.2.9 Survey Report Requirements

### 2.2.9.1 General

**[DO-SVY-1490]** All survey work undertaken to determine the co-ordinates of aeronautical data/information shall be reported as metadata in compliance with ISO 19115:2003 [RD 22].

Note: Under the term “survey work” fall, inter alia, preparation (selection of reference co-ordinates), data transfer (to and from sensor), survey, control-survey, data processing and feature processing or feature-extraction.

**[DO-SVY-1500]** The level of detail recorded in metadata shall allow for the traceability of aeronautical data/information and the assessment of its suitability for use.

**[DO-SVY-1510]** Survey reports for control stations should extract selected metadata in order to provide all the relevant documentation (sitemap, co-ordinates, quality evaluation, monumentation) as a summary for subsequent use.

**[DO-SVY-1520]** The organisation responsible for the survey shall be reported in the metadata, in accordance with ISO 19115:2003 [RD 22] section 6.3.2.2.

**[DO-SVY-1530]** The purpose of the survey shall be stated in the metadata (see ISO 19115:2003 [RD 22] section 6.3.2.2).

**[DO-SVY-1540]** The geodetic connection should be fully described, where monumented survey control stations are not installed as part of an off-aerodrome radio navigation facility survey.

### 2.2.9.2 Lineage Information

**[DO-SVY-1550]** Lineage information shall be reported in the metadata, in accordance with ISO 19115:2003 [RD 22] section 6.3.2.4.

**[DO-SVY-1560]** Each processing step, with its date and time stamp, should be recorded as individual lineage information.

Note: A link between raw data, parameters, intermediate data and the process step should be maintained to simplify traceability.

**[DO-SVY-1570]** Each process step should be recorded with a level of detail that allows an independent specialist to easily comprehend the intended process and how this was applied.

**[DO-SVY-1580]** For each processing step, the name and role of the person that has interacted with the data shall be included in the lineage information.

**[DO-SVY-1590]** The method and sensor (equipment) used for data origination shall be included in the lineage information.

Note: The aviation profile of ISO 19115:2003 [RD 22] is intended to cover sensor and tool information as part of the process steps.

**[DO-SVY-1600]** Any calibration of a deployed sensor (equipment) should be recorded as an individual process step.

**[DO-SVY-1610]** When data from a third party supplier has been used in the data origination process (e.g. permanent GNSS network, geoid model), appropriate information regarding the data shall be recorded as metadata to ensure traceability.

Note: This information should include, as a minimum, the identification, point of contact (using MD\_IdentificationCitation) and the determined limitations, as MD\_Usage, in accordance with ISO.

### 2.2.9.3 Data Quality Information

**[DO-SVY-1620]** Data validation tasks shall be recorded in the metadata, in accordance with ISO 19115:2003 [RD 22] Section 6.3.2.4.

### 2.2.10 Training and Qualification

**[DO-SVY-1630]** All surveyors undertaking data origination activities should hold a professionally accredited qualification and/or be a member of a professional body that has a membership or is affiliated with the Fédération Internationale des Géomètres<sup>29</sup> or the International Society of Photogrammetry and Remote Sensing<sup>30</sup>.

## 2.3 Instrument Flight Procedure Design

### 2.3.1 General

**[DO-FPD-010]** Instrument flight procedures must be designed in accordance with the criteria laid down in ICAO Doc 8168 (Aircraft Operations) Volume II [RD 12] and further detailed in ICAO Doc 9368 (Instrument Flight Procedures Construction Manual) [RD 14] or, where appropriate, ICAO Doc 9905 (Required Navigation Performance(RNP) Authorization Required (RNP AR) Procedure Design Manual) [RD 18].

---

<sup>29</sup> <http://www.fig.net/>

<sup>30</sup> <http://www.isprs.org/>

Note: ICAO Doc 9368 [RD 14] applies to legacy instrument flight procedures based upon conventional (non-Performance-based Navigation (PBN)) navigation.

**[DO-FPD-020]** Divergence from those documents specified in DO-FPD-010 should be supported by comprehensive analysis, with supporting flight trials data and the analysis, results and conclusions of these recorded.

**[DO-FPD-030]** The runways for which instrument flight procedures are designed must be protected by obstacle limitation surfaces which have the physical characteristics detailed in ICAO Annex 14, Volume 1 (Aerodromes) [RD 7].

**[DO-FPD-040]** Where States elect to apply national criteria for instrument flight procedure design and/or obstacle limitation, they should ensure that the modifications do not result in any increase in risk to the intended operation.

**[DO-FPD-050]** Any national criteria should be fully justified, documented and supported by a detailed safety case, which has been approved by the appropriate regulator.

**[DO-FPD-060]** ICAO Doc 9613 (PBN Manual) [RD 16] and the references contained therein must be considered when designing PBN routes and procedures.

**[DO-FPD-070]** The control of obstacles around non-instrument runways for which Special-VFR procedures are defined must be protected by obstacle limitation surfaces which have the physical characteristics detailed in ICAO Annex 14, Volume 1 (Aerodromes) [RD 7].

**[DO-FPD-080]** Obstacle restriction and removal around heliports must be carried out in accordance with ICAO Annex 14 Volume 2 [RD 8].

**[DO-FPD-090]** Aeronautical information, and terrain and obstacle data sources shall be documented.

**[DO-FPD-100]** The designer shall be responsible for the verification of received data and the validation of data critical to the design.

**[DO-FPD-110]** Where the necessary level of accuracy cannot be assured for terrain and obstacle data, the designer should apply appropriate mitigations.

Note: An acceptable mitigation would be to apply additional lateral and vertical buffers to accommodate the potential errors.

**[DO-FPD-120]** Where the necessary level of accuracy cannot be assured for terrain and obstacle data, the State should ensure that a flight validation is carried out to provide a final validation of the critical obstacles.

**[DO-FPD-130]** Electronic data transfer and storage should be used wherever possible.

**[DO-FPD-140]** Where manual data entry is used, additional verification checks shall be applied to ensure that no errors have been introduced.

**[DO-FPD-150]** The instrument flight procedure designer should maintain close co-ordination with all relevant stakeholders throughout the design process.

**[DO-FPD-160]** The operating procedures of organisations responsible for instrument flight procedure design may address co-ordination with Data Service Providers to assist in ensuring that the instrument flight procedures developed may be correctly processed for inclusion within aircraft flight management systems.

### 2.3.2 Training and Qualification of Designers

**[DO-FPD-170]** Instrument flight procedure designers shall be suitably qualified and shall have successfully completed recognised training courses.

**[DO-FPD-180]** Specialist courses related to appropriate PBN operations should be completed prior to commencing the design of any PBN instrument flight procedures.



Note: Guidance on the development of flight procedure designer training is provided in ICAO Doc 9906 (Quality Assurance Manual for Flight Procedure Design, Volume 2 Flight Procedure Designer Training) [RD 28].

### 2.3.3 Validation and Verification of Instrument Flight Procedures

**[DO-FPD-190]** Prior to publication, the instrument flight procedure shall be validated to ensure that the design is correct, the procedure is flyable and the procedure description is complete and coherent.

Note: Guidance on the validation of instrument flight procedures is provided in the ICAO Doc 9906 (Quality Assurance Manual for Flight Procedure Design, Volume 1 Flight Procedure Design Quality Assurance System [RD 28] and Volume 5 Flight Validation of Instrument Flight Procedures).

**[DO-FPD-200]** An instrument flight procedure design shall be independently checked by a qualified instrument procedure designer prior to publication.

**[DO-FPD-210]** The checking process shall ensure that the data used in the design has been verified and validated, that criteria have been applied correctly, that the available guidance has been followed, that the proposed procedure meets the requirements for the intended operation and that the publication data is complete and coherent.

Note: Flight validation may be used as part of this process.

**[DO-FPD-220]** The results of the validation and verification, together with the conclusions, shall be recorded in the metadata for the procedure.

Note: Guidance on the verification of Instrument Flight Procedure Designs is provided in ICAO Doc 9906 (Quality Assurance Manual for Flight Procedure Design, Volume 1 Flight Procedure Design Quality Assurance System) [RD 28].

**[DO-FPD-230]** In addition to the verification process, all PBN procedures should be validated and checked for fly-ability.

Note<sub>(1)</sub>: Guidance on validation and flyability checks are provided in ICAO Doc 9906 (Quality Assurance Manual for Flight Procedure Design, Volume 5 Flight Validation of Instrument Flight Procedures) [RD 28].

Note<sub>(2)</sub>: The EUROCONTROL RNAV Validation Tool is available to support the validation process and the flyability assessment.

### 2.3.4 Flight Validation

**[DO-FPD-240]** A flight validation may be used to check:

- The obstacle environment against which the instrument flight procedure has been designed: However, where a State has not followed the recommendation of paragraph 10.1.6 of ICAO Annex 15 [RD 9] namely "*At aerodromes regularly used by international civil aviation, electronic terrain and obstacle data should be provided for Areas 2b, 2c and 2d for obstacles and terrain that penetrate the relevant obstacle data collection surface specified in Appendix 8, except that data need not be collected for obstacles less than a height of 3 m above ground in Area 2b and less than a height of 15 m above ground in Area 2c*", this recommendation should be treated as a requirement as there is a lack of assurance as to the adequacy of the terrain and obstacle data survey;
- The flyability of the procedure: flyability checks are best conducted using flight deck simulators. For this check, simulators of a representative range of the aircraft types expected to use the instrument flight procedure should be

used and the checks should include the range of Flight Management System (FMS)/RNAV options with which these aircraft are equipped. The applicability of a flight validation check is restricted to the aircraft type used for the flight check and the prevailing weather conditions at the time of the flight check. It is, therefore, of limited value in determining the flyability of the procedure for the range of aircraft and a range of meteorological conditions;

- The correctness of the waypoint data and the supporting fix, track and distance data. This does not constitute a check of the operational database as flight validations are generally carried out prior to the effective date of the procedure;
- The charting, required infrastructure, visibility and other operational factors;
- The airport infrastructure, including runway classification, lighting, communications, runway markings and availability of local altimeter setting.

Note<sub>(1)</sub>: Flight validation provides a means, but not the only means, of instrument flight procedure validation.

Note<sub>(2)</sub>: Minor modifications to existing instrument flight procedures do not usually require additional flight checks.

Note<sub>(3)</sub>: Further guidance on the flight inspection of instrument flight procedures is provided in the ICAO Doc 8071 (Manual on Testing of Radio Navigation Aids) Volume I [RD 25] and Volume II [RD 26] and in the EUROCONTROL Guidelines for P-RNAV Infrastructure Assessment [RD 31]. Further guidance on flight validation of instrument flight procedures is provided in ICAO Doc 9906 (Quality Assurance Manual for Flight Procedure Design, Volume 5 Ground and Flight Validation of Instrument Flight Procedures) [RD 28].

Note<sub>(4)</sub>: Procedures designed using the standard T or Y procedure design methodology will not normally require flyability checks.

### 2.3.5 Flight Inspection

**[DO-FPD-250]** Flight inspection may be necessary to validate the Navaid coverage and performance assumptions made during the instrument flight procedure design process<sup>31</sup>.

**[DO-FPD-260]** A flight inspection should address the following areas:

- The coverage and compliance to the signal in space requirements of ICAO Annex 10, Volume 1 [RD 5] by the relevant ground Navaid infrastructure over the whole procedure.
- The identification of any electromagnetic interference or other distortions, e.g. multipath, that has a deleterious effect on the received Navaid signals, which should always include GNSS frequency bands.

Note<sub>(1)</sub>: Depending on test aircraft equipment and crew qualification, flight inspection and flight validation may be combined.

Note<sub>(2)</sub>: Further guidance on the flight inspection is provided in the ICAO Doc 8071 (Manual on Testing of Radio Navigation Aids) [RD 25].

---

<sup>31</sup> The flight inspection addresses the quality of the navigation signal received along the length of the procedure. While the output from this process does not feed directly into the AIP, it does form part of the quality process necessary to assure the viability of the instrument flight procedure.

### 2.3.6 Quality Records

**[DO-FPD-270]** All instrument flight procedures shall be traceable to their source of production by an unbroken audit trail recorded as metadata.

**[DO-FPD-280]** Information to be recorded in the audit trail on the source of production shall include, as a minimum:

- a) Name of procedure designer;
- b) Design organisation;
- c) Date of design;
- d) Design rationale;
- e) Version of applicable design criteria used;
- f) Data sources;
- g) Parameters used;
- h) Design assumptions and constraints;
- i) Name of design validator;
- j) Date of design approval.

## 2.4 Airspace and ATS Route Planning

### 2.4.1 General

**[DO-ASD-010]** Airspace planners must follow the criteria laid down in ICAO Annex 11 [RD 6], ICAO Doc 4444 (Air Traffic Management) [RD 10], ICAO Doc 8168 (Aircraft Operations) Volume II [RD 12] and ICAO Doc 9689 (Manual on Airspace Planning Methodology for the Determination of Separation Minima) [RD 17].

**[DO-ASD-020]** ATS Routes must be designed in accordance with the:

- a) Obstacle clearance criteria laid down in ICAO Doc 8168 (Aircraft Operations) Volume II [RD 12] or, where appropriate, ICAO Doc 9905 RNP AR Procedure Design Manual) [RD 18] and,
- b) Route spacing criteria laid down in ICAO Annex 11 Attachment A [RD 6], ICAO Doc 4444 [RD 10], ICAO Doc 9426 [RD 15], ICAO Doc 9689 [RD 17] and ICAO Circular 120 [RD 19].

**[DO-ASD-030]** Divergence from the guidance detailed in DO-ASD-020 should be supported by a comprehensive analysis, with supporting flight data and the analysis, results and conclusions recorded.

**[DO-ASD-040]** Where States choose to apply national criteria, they should ensure that the modifications do not result in any increase in risk to the intended operation.

**[DO-ASD-050]** Where States choose to apply national criteria they must notify ICAO of a difference in relation to Annex 11 [RD 6] and ensure that it is published within the National AIP.

**[DO-ASD-060]** The justification for applying national criteria and the modified criteria should be clearly documented.

**[DO-ASD-070]** Any national criteria should be fully justified, documented and supported by a detailed safety case, which has been approved by the appropriate regulator.

**[DO-ASD-080]** Airspace planners should take account of the guidelines provided in EUROCONTROL ASM.ET1.ST03.4000.EAPM.02.02 (Airspace Planning Manual) [RD 2].

Note: The EUROCONTROL System for Traffic Assignment & Analysis at Macroscopic Level (SAAM) tool may be used to support the airspace planning and design process.

**[DO-ASD-090]** Any major changes impacting on airspace structures or ATS routes in neighbouring States should be co-ordinated at an international (Regional) level.

**[DO-ASD-100]** The designed limits of airspace structures must include vertical and horizontal dimensions.

**[DO-ASD-110]** The designed limits should not overlap associated protected airspaces unless appropriate operating procedures have been formally agreed between the authorities responsible.

**[DO-ASD-120]** Where common boundaries exist, these shall be formally co-ordinated with the authority responsible for the neighbouring airspace.

**[DO-ASD-130]** The horizontal dimensions shall be defined with reference to WGS-84.

**[DO-ASD-140]** The vertical dimensions must be defined with reference to FL, GND or MSL.

**[DO-ASD-150]** Aeronautical information, terrain and obstacle data sources should be recorded as metadata.

**[DO-ASD-160]** Electronic data transfer and storage should be used wherever possible.

**[DO-ASD-170]** Where manual data entry is used, additional verification checks shall be applied to ensure that no errors have been introduced.

#### **2.4.2 Quality Records**

**[DO-ASD-180]** All airspace structures shall be traceable to their source of production by an unbroken audit trail.

**[DO-ASD-190]** Information on the source of production shall include:

- a) Name of Airspace Designer;
- b) Design organisation;
- c) Date of design.

**[DO-ASD-200]** Records shall be maintained for the lifetime of the airspace structure and for at least five years following the end of that period or until five years after the end of the period of validity for any data item calculated or derived from it, whichever is later.

## Annex A CONFIGURATION CONTROL

### A.1 ELEMENT IDENTIFICATION

Name	ID	Edition
EUROCONTROL Specification for the Origination of Aeronautical Data	EUROCONTROL-SPEC-154	1.0

### A.2 ELEMENT CHANGE RECORD

A.2.1 The following table records the complete history of the successive editions of specifications.

Specification Document Identifier	Edition Number	Edition Date	Reason for Change	Sections Affected
EUROCONTROL-SPEC-154	1.0	04/02/2013	Initial Specification	All

## Annex B HORIZONTAL REFERENCE SYSTEMS

### B.1 Introduction

B.1.1 In section 2.1.2.1 of this EUROCONTROL Specification, the requirements on the use of the horizontal reference system for the spatial definition of aeronautical information are provided. This section provides additional information and definitions which should help in the implementation of the correct reference system.

Note: The geodetic descriptions given here are considered to be sufficient for aviation purposes. They are not intended as definitive geodetic statements.

### B.2 Definitions

#### B.2.1 Geodetic Reference System

B.2.1.1 A reference system provides a definition of a co-ordinate system in terms of the position of an origin in space, the orientation of an orthogonal set of Cartesian axes, and a scale. A terrestrial reference system defines a spatial reference system in which positions of points anchored on the Earth's solid surface have co-ordinates. Examples are WGS-84, ITRS/European Terrestrial Reference System (ETRS) and national reference systems.

#### B.2.2 Geodetic Reference Frame

B.2.2.1 A reference frame is a realisation of a reference system through a consistent set of three-dimensional station co-ordinates, taking into account the continental drifts. Examples are ITRF89, ITRF97, ITRF2000 and ITRF2005. Due to plate tectonics and tidal deformation, the co-ordinates for a point change between the different ITRF realisations. The realisations are also referred to as versions.

#### B.2.3 WGS-84

B.2.3.1 WGS-84 defines, inter alia, a conventional terrestrial reference system, a reference frame and a reference ellipsoid<sup>32</sup>. The system was developed by the United States Department of Defence, together with scientists of other States and institutions. WGS-84 is currently the reference system ICAO requires for geo-referencing aeronautical information.

##### B.2.3.2 Definition of the WGS-84 Reference System

B.2.3.2.1. The WGS-84 co-ordinate system is a right-handed, Earth-fixed orthogonal co-ordinate system. In the National Imaging and Mapping Agency TR8350.2 - Department of Defense, WGS-84, [RD 30], the WGS-84 is characterised as follows:

- a) It is geocentric, the centre of mass being defined for the whole Earth, including oceans and atmosphere;
- b) Its scale is that of the local Earth frame, in the sense of a relativistic theory of gravitation;
- c) Its orientation was initially given by the Bureau International de l'Heure (BIH) orientation of 1984.0;

---

<sup>32</sup> More information can be found at:  
[http://earth-info.nga.mil/GandG/publications/tr8350.2/tr8350\\_2.html](http://earth-info.nga.mil/GandG/publications/tr8350.2/tr8350_2.html).

- d) Its time evolution in orientation will create no residual global rotation with regards to the crust.

### B.2.3.3 WGS-84 as a Reference Frame

- B.2.3.3.1. The set of definitions for WGS-84 not only includes a reference system, but also the practical realisation of a reference frame through a set of station co-ordinates. The latest available frame is called 'WGS-84 (G873)', where the letter 'G' indicates that the station co-ordinates has been derived by Global Positioning System (GPS) techniques and the number following the 'G' indicates the GPS week number in which these co-ordinates were implemented (January 29, 1997). The accuracy of the station co-ordinates is in the order of 5cm ( $1\sigma$ ).

### B.2.3.4 Geometric Constants of the WGS-84 Ellipsoid

- B.2.3.4.1. Part of the WGS-84 definition is the ellipsoid as a geometric (mathematical) reference surface. Geometric constants of the WGS-84 ellipsoid should be as described in Table 2 and Table 3.

Semi-major axis	$a = 6378137.000 \text{ m}$
Reciprocal of Flattening	$f = 1/298.257223563$
Angular Velocity of the earth	$\omega = 7292115.0 \times 10^{-11} \text{ rad/s}$
Gravitational Constant	$GM = (3986004.418 \pm 0.008) \times 10^8 \text{ m}^3/\text{s}^2$

**Table 2: Geometric Constants**

Semi-minor axis	$b = 6356752.3142 \text{ m}$
First eccentricity	$e = 8.1819190842622 \times 10^{-2}$
(First eccentricity) <sup>2</sup>	$e^2 = 6.69437999014 \times 10^{-3}$
Mean Radius of Semi-Axes	$R1 = 6371008.7714 \text{ m}$

**Table 3: Some of WGS-84 Ellipsoid Derived Geometric Constants**

## B.2.4 The International Terrestrial Reference System (ITRS)

- B.2.4.1. Like WGS-84, the ITRS is a horizontal reference system. The ITRS is maintained by the International Earth Rotation and Reference Systems Service (IERS) and the realisation of the ITRS is the ITRF<sup>33</sup>.

- B.2.4.2. Plate tectonic movement has been incorporated in this co-ordinate system using results of recent measurements and a global geophysical model. Thus, it is a model with changing co-ordinates due to the movements of the tectonic plates on which the ground stations are located. However, this reference system provides the fundamental position of the Earth to within 10cm and the orientation of the axes to correspondingly high accuracies. Since 1988, the IERS has defined the mean spin axis, the IERS Reference Pole (IRP), the zero meridian and the IERS Reference Meridian (IRM).

<sup>33</sup> The main web source for information related to ITRS/ITRF is: <http://itrf.ensg.ign.fr/>.

B.2.4.3 Whilst WGS-84 is a static model, the maintenance of a dynamic datum with a higher level of accuracy, like ITRS, requires constant monitoring of the rotation of the Earth, the motion of the pole and the movement of the plates of the crust of the Earth on which the ground stations are located. Where WGS-84 is strictly speaking defined by only 13 reference stations globally, ITRS is built upon a network of many reference stations. The continuous measurement from these stations is used to determine the dynamic variables of the ITRS.

## **B.2.5 International Terrestrial Reference Frame (ITRF)**

B.2.5.1 The ITRF is an accurate geodetic reference frame that consists of a globally distributed network of survey stations whose positions and velocities are determined by several independent measurement technologies. Positions and velocities are published periodically by the IERS, and each published set is identified by the epoch of the station positions. Thus, the published position of a point in ITRF97 is valid at the epoch 1st January 1997, whereas the position of the point at some future time must take into account the effect of the point's velocity. The ITRF identifies, inter alia, changes resulting from earth tectonic plate movements, so it is important that a survey record includes the epoch number for the ITRF used. The continental drift can be as much as 10cm per year (Australia), resulting in differences between co-ordinates of a point expressed in ITRF96 in relation to a point expressed in ITRF2006 of 97cm (see Table 4). In the table, the co-ordinates and annual change rates (in italic) of different sites are provided in the ITRF96 and ITRF2006 frame, along with the 3D distance between the two co-ordinates. For the stations Padova and Ankara, the co-ordinates are also provided in the corresponding ETRF96/2005 realisations. The 3D distance in ETRF is much smaller compared to ITRF since the two stations are part of the definition of the ETRF, i.e. ETRF is shifted compared to ITRF because of the movement of the European plate. As Ankara is located at the border of the European plate, it is impacted by a plate rotation and therefore has a larger shift in ETRF than Padova.



		Co-ordinates expressed in ITRF96 frame			Co-ordinates expressed in ITRF2005 frame			
		Station Positions and velocities at Epoch 1996/01/01			Station Positions and velocities at Epoch 2010/01/01			
Site Name	State	X/Nx	Y/Ny	Z/Nz	X/Nx	Y/Ny	Z/Nz	3D-Distance
		<i>m-m/y</i>	<i>m-m/y</i>	<i>m-m/y</i>	<i>m-m/y</i>	<i>m-m/y</i>	<i>m-m/y</i>	
Padova	IT	4389531.313	923253.634	4519256.328	4389531.06	923253.874	4519256.495	0.39 cm
		<i>-0.014</i>	<i>0.0166</i>	<i>0.0121</i>	<i>-0.0172</i>	<i>0.0177</i>	<i>0.0113</i>	
ETRF96/05		4389531.452	923253.559	4519256.194	4389531.444	923253.543	4519256.219	0.03 cm
Ankara	TR	4121934.348	2652190.008	4069035.119	4121934.467	2652190.361	4069035.4	0.47 cm
		<i>-0.0072</i>	<i>-0.0023</i>	<i>0.0077</i>	<i>0.0143</i>	<i>0.0331</i>	<i>0.0227</i>	
ETRF96/05		4121934.44	2652190.065	4069035.016	4121934.598	2652189.89	4069035.024	0.24 cm
Urumqi	CN	228310.768	4631922.915	4367064.059	228310.313	4631922.746	4367064.046	0.49 cm
		<i>-0.0268</i>	<i>-0.0045</i>	<i>0.0056</i>	<i>-0.0315</i>	<i>-0.0037</i>	<i>0.0047</i>	
Yarragadee	AU	-2389025.489	5043316.869	-3078530.788	-2389026.153	5043317.006	-3078530.083	0.98 cm
		<i>-0.0498</i>	<i>0.0056</i>	<i>0.0491</i>	<i>-0.0476</i>	<i>0.0094</i>	<i>0.0499</i>	
Algonquin	CA	918129.293	-4346071.292	4561977.878	918129.525	-4346071.229	4561977.818	0.25 cm
		<i>-0.0157</i>	<i>-0.0036</i>	<i>0.0038</i>	<i>-0.0157</i>	<i>-0.0023</i>	<i>0.0003</i>	
Santiago	CL	1769693.643	-5044574.175	-3468320.869	1769693.317	-5044574.138	-3468321.069	0.38 cm
		<i>0.0239</i>	<i>-0.0039</i>	<i>0.0125</i>	<i>0.0219</i>	<i>-0.0074</i>	<i>0.007</i>	
Hartebeesthoek	ZA	5085442.778	2668263.737	-2768696.79	5085442.779	2668263.464	-2768697.05	0.38 cm
		<i>-0.0019</i>	<i>0.019</i>	<i>0.0167</i>	<i>0.0007</i>	<i>0.0192</i>	<i>0.0164</i>	
Reykjavik	IS	2587384.206	-1043033.536	5716564.055	2587384.523	-1043033.492	5716563.965	0.33 cm
		<i>-0.0216</i>	<i>-0.0028</i>	<i>0.0059</i>	<i>-0.022</i>	<i>-0.0039</i>	<i>0.0096</i>	

**Table 4: Continental Drift Expressed in Different ITRF Epochs<sup>34</sup>**

<sup>34</sup> Source <http://www.iers.org>. For the stations 'Padova' and 'Ankara', the corresponding ETRF co-ordinates are shown too. It is clear that the movement of the European plate is reflected in ETRF and the co-ordinates of these two stations do not differ as much in ETRF as they do in ITRF.

B.2.5.2 The ITRF uses the same system parameters as WGS-84. Therefore, for practical terms in aviation (navigation as well as data provision), the two frames can be regarded as identical.

## **B.2.6 European Terrestrial Reference System 1989 (ETRS89)**

B.2.6.1 ETRS89 is a reference system defined by the sub-commission of EUREF of the International Association for Geodesy in 1989. The system is derived from ITRS and therefore closely linked to ITRS; it uses the same ellipsoid (Geodetic Reference System (GRS) 1980), and the same fundamental point and scale. The spatial orientation has been chosen in such a way that the system follows the movement of the Eurasian tectonic plate. Therefore, the co-ordinate of a point in central and northern Europe remains stable within the ETRS89 (internally consistent).

B.2.6.2 The ETRS89 is the base (because it is dynamic) for many national “modern” terrestrial reference systems. Modern (national or continental) reference systems distinguish themselves by a precisely defined link to the global system, allowing absolute positioning with centimetre-accuracy for any point in time, from its establishment. This can be achieved through the complex modelling of the relationship, based on epochs and velocities (i.e. the amount of drift between the two systems).

## **B.2.7 European Terrestrial Reference Frame (ETRF)**

B.2.7.1 ETRF is a precise geodetic reference frame established by a number of survey stations throughout Europe whose relative positions are known to an accuracy in the order of 2-3cm. For the realisation of ETRS (ETRF89...ETRF2000), the positions of the ITRS stations in and around Europe, at the beginning of 1989, were used as a reference. Only stations on the stable part of the Eurasian plate were used as these are considered to be consistent. Co-ordinates of the stations used for the realisation are the same in ITRF89 and ETRF89.

B.2.7.2 Due to the continental drift of the Eurasian plate, ITRF2000 and ETRF89 co-ordinates differed by about 25cm in the year 2000, a difference which is increasing by about 2.5cm per year.

B.2.7.3 More than 200 stations forming the EUREF Permanent Network (EPN) publish their GNSS data freely over the internet which allows the co-ordinate of any location within Europe to be easily determined with centimetre accuracy.

## **B.2.8 Relationship Between WGS-84, ITRF and ETRF**

B.2.8.1 The theoretical principles of WGS-84, ITRS and ETRS89 systems are the same. For WGS-84, the position of the reference ellipsoid was initially calculated on the basis of available data and modelled as a best-fit for the whole world but with limited precision (initially with 1-2 metres, the latest models with 5cm). ITRS 2000 is practically identical to the latest instantiation of WGS-84.

B.2.8.2 ETRF89 was identical to ITRF at the 1989 epoch. ETRF is only used in Europe but the relationship between ITRF and ETRF is well known and transformation parameters are available for the various epochs.

B.2.8.3 The reference network for WGS-84 consists of only 12 stations around the world, whereas the EPN consists of over 200 stations within Europe. In practical terms, this means that GNSS surveys within Europe are most easily realised if they are based on ETRS89, and subsequently converted to the appropriate epoch of ITRS, presently ITRS 2000.

---

## **B.3 Recommendations**

### **B.3.1 Determining Position in ITRF**

B.3.1.1 There are two options for fixing a survey station to the current ITRF, namely direct and indirect connection.

1) For the direct connection to ITRF method:

Using this method, the surveyor establishes a direct connection between an ITRF station and the new point, using a GNSS technique. The GNSS data from a permanent reference network site with ITRF co-ordinates and velocities are used in conjunction with GNSS data acquired at the required point by the surveyor. The two data sets are processed in a geodetic application to determine the co-ordinate of the required point. This option enables direct connection to the ITRF in a relatively simple and established way. The parameters and the length of the data acquisition should be chosen carefully depending on the base line length. Whenever possible, more than one reference station in ITRF should be used to ensure that the connection to the reference frame is robust in terms of redundancy.

2) For the indirect connection through regional reference frame and transformation method:

In order to avoid the difficulties associated with long base lines, the co-ordinates of the required point may be determined by measurements relative to a reference station, in a regional reference frame, such as ETRF. The survey procedure is the same as for direct connection. Once the co-ordinates are known in the regional reference frame, they should be transformed to ITRF using the available transformation parameters. The user should ensure that the proper epoch is used when selecting the transformation parameters. An alternative approach within Europe is to first establish the co-ordinates of the control station by fixing to ETRF89 using EUREF (or other suitable stations derived from the EUREF network) stations. These co-ordinates can then be transformed to ITRF using the appropriate transformation parameters (see paragraph G.3.1)<sup>35</sup>.

B.3.1.2 Whilst the differences between coordinate systems ITRF and ETRF, or ETRF89 and ETRF2000 are significant in terms of horizontal accuracy required by the aeronautical data items, their absolute differences are too small to assure correct identification by means of the data values themselves. Therefore, it is essential that the reference frame used is identified and the surveyor should ensure that with each co-ordinate, the horizontal reference frame and the epoch are stored.

### **B.3.2 Monitoring and Updating Co-ordinates Due to Continental Drift**

B.3.2.1 Whilst the use of ETRF89 is conceptually simple and relatively easy to manage, it introduces one fundamental problem. The ETRF89 network is gradually drifting away from the ITRF at a rate of 2-3cm per year and, for some locations around the world, the drift of the tectonic plate compared with ITRF can be as large as 10cm per year. To achieve global harmonisation, ICAO requires all co-ordinates to be published in WGS-84 which ICAO has, in Annex 15, equated to ITRF2000.

B.3.2.2 In the long-term, the difference between a regional reference frame and ITRF (and hence WGS-84) co-ordinates for the same point could become too great to meet the ICAO Annex 15 requirements [RD 9]. However, as long as all GNSS

---

<sup>35</sup> This method may be beneficial to a number of States since the availability of a relatively dense network of stations as a result of the EUREF campaign simplifies the logistics involved in establishing the position of the control station.

measurements are based on differential vectors between a known co-ordinate and a new position, the drift does not impact the (relative) measurement. Therefore, all co-ordinates published in any aviation data set should be referenced to ITRF2000. Combining different versions of a reference frame within the same data set should be avoided.

- B.3.2.3 When the geodetic body responsible for publishing the regional reference frame provides accurate transformation to ITRF at any epoch, the co-ordinates determined by the indirect connection method (as mentioned above) should be transformed to ITRF2000.
- B.3.2.4 Where a local geodetic control network has been established for the surveying of aeronautical features, the transformation of the geodetic control network to ITRF2000 should be determined by resurvey. The transformation parameters should then be applied to all co-ordinates linked to at least one of the control network stations.
- B.3.2.5 At least every five years, the co-ordinates of the required point should be resurveyed.

## **B.4 Resources**

### **B.4.1 Free Data Services**

- B.4.1.1 Several sources of free GPS and reference frame data are accessible via the Internet. These can be used to gain access to the definitions and transformations for ITRF and ETRF in a relatively straightforward manner:
- International GNSS Service (IGS) products (precise orbits, satellite clock models): National Aeronautics and Space Administration (NASA) website<sup>36</sup>;
  - EUREF GPS Receiver Independent Exchange Format (RINEX) data: EUREF website<sup>37</sup>;
  - ETRS to ITRS transformations: EUREF website<sup>38</sup>;
  - International Earth Rotation Service (IERS) products: IERS website<sup>39</sup>;
  - Crustal Dynamics Data Information Service (CDDIS): CDDIS (NASA) website<sup>40</sup>.

### **B.4.2 Other Useful Websites**

- B.4.2.1 Resources for information on reference systems, networks and techniques:
- EUREF Permanent network site<sup>41</sup>;
  - GPS time and date converter (useful as part of the on-line data acquisition service), available on the Scripps Orbit and Permanent Array Center (SOPAC) website<sup>42</sup>;

---

<sup>36</sup> <http://igscb.jpl.nasa.gov> correct on 05/07/07.

<sup>37</sup> <http://www.epncb.oma.be/dataproducts/datacentres/index.php> correct on 05/07/07.

<sup>38</sup> <http://www.epncb.oma.be/trackingnetwork/coordinates/stationcoordinates.php> correct on 05/07/07.

<sup>39</sup> <http://www.iers.org> correct on 05/07/07.

<sup>40</sup> <http://cddisa.gsfc.nasa.gov/cddis.html> correct on 05/07/07.

<sup>41</sup> <http://www.epncb.oma.be> correct on 05/07/07.

- US Coastguard Navigation Centre website (general information on GPS status and development)<sup>43</sup>;
- European GNSS Supervisory Authority (European Geostationary Navigation Overlay Service (EGNOS), GALILEO) website<sup>44</sup>;
- Federal Space Agency Russia, Information-Analytical Centre (GLONASS provider) website<sup>45</sup>.

---

<sup>42</sup> <http://sopac.ucsd.edu/scripts/convertDate.cgi> correct on 05/07/07.

<sup>43</sup> <http://www.navcen.uscg.gov/gps/default.htm> correct on 05/07/07.

<sup>44</sup> <http://www.gs.europa.eu> checked September 09.

<sup>45</sup> <http://www.glonass-ianc.rsa.ru> checked September 09.

## Annex C VERTICAL REFERENCE SYSTEMS

### C.1 Definitions

#### C.1.1 Vertical Reference System

C.1.1.1 A vertical (height) reference system can be defined by only two parameters: A point with a known elevation from which vertical differences are calculated, and the reference surface. The different height systems are briefly explained below.

#### C.1.2 Ellipsoidal Heights

C.1.2.1 The ellipsoid, which is used as part of the definition of a geodetic datum, can be used as a reference surface. The Ellipsoidal Height is the orthogonal distance between a point and the reference ellipsoid. Therefore, it does not take into account the Earth's gravity field.

#### C.1.3 Orthometric Heights

C.1.3.1 The orthometric height is the distance (H) along a line of force from a given point (P) on the physical surface of the earth to the geoid (the line is perpendicular to the equipotential surfaces at different levels).

#### C.1.4 Normal Heights

C.1.4.1 The Normal Height (H\*) of a point is computed from its geopotential difference to that of sea level. It takes into account the normal gravity, computed along the plumb line of the point (height difference of a point to the quasi-geoid). The difference between the Normal Height and the Ellipsoidal Height is called height-anomaly or quasi-geoid-height.

#### C.1.5 Geoid – Earth Gravitational Model (EGM)

C.1.5.1 The geoid is the equipotential surface of the earth's gravity field, chosen at a certain level (approximately MSL) which serves as the reference surface for height measurements. Globally, the difference in elevation between the geoid and the geocentric ellipsoid is between  $\pm 100\text{m}$ .

C.1.5.2 Global and local geoids differ in their origin: global geoids consider only the long- and middle-wave part of the earth's gravity field, whilst local geoids also consider the short-wave part of the gravity field. Global geoids are used when consistent orthometric heights, over long distances (continent or earth surveying), are required. Currently, the world's best global geoid model is EGM 2008<sup>46</sup>. It was determined using satellite tracking, gravity anomalies and satellite altimetry. Its accuracy is in the range of  $\pm 0.05\text{ m}$  (oceans) and  $\pm 0.5\text{ m}$  (on land). This accuracy is higher in flat regions than in topographically mountainous terrain, such as the Alps.

C.1.5.3 For local engineering applications and cadastre-surveying, global geoids are not as accurate as needed. For such applications, local geoid models are calculated. These can only be developed using local field measurements. They offer centimetre accuracy over several hundred kilometres, with a high resolution. Local

---

<sup>46</sup> <http://earth-info.nga.mil/GandG/WGS-84/gravitymod/egm2008/index.html>.

geoids are not suitable for height comparison over large distances since they are based on different origins and reference heights (different equipotential levels).

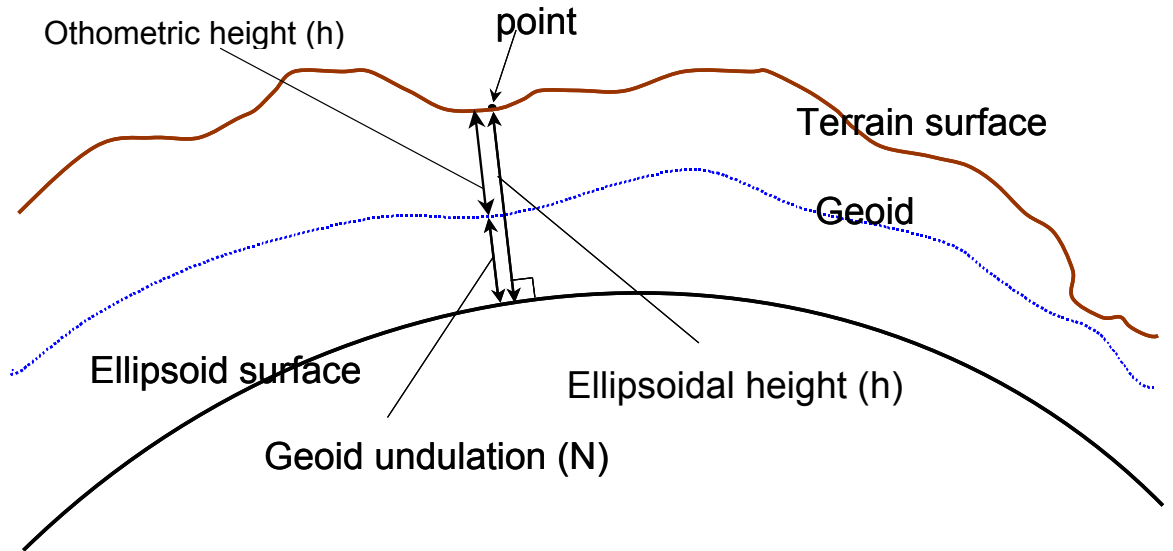

**Figure 1: Geoid Undulations with Respect to an Ellipsoid**

## **C.1.6 European Vertical Reference System**

C.1.6.1 The European Vertical Reference System (EVRS) has been built to reflect the globalisation of GIS applications and the need for continental-wide, consistent height information. EVRS is a gravity-related height reference system, i.e. the height values provided are Normal Heights. The EVRS is a tidal zero system. The EVRS is realised in the European Vertical Reference Frame (EVRF) by the geopotential numbers and Normal Heights of nodal points of the United European Levelling Network 95/98 extended for Estonia, Latvia, Lithuania and Romania, in relation to the Normaal Amsterdams Peils (NAP). The geopotential number at NAP is zero.

## **C.2 Recommendations for Determining Heights Relative to EGM-96**

### **C.2.1 Introduction**

C.2.1.1 The ICAO SARPs mandate that all height information should be published relative to MSL (orthometric heights). To determine the geoid undulation, EGM-96 should be used but may be replaced by a more accurate geoid model where the accuracy of EGM-96 is not sufficient.

C.2.1.2 The most stringent accuracy requirements covered by the standards are geoid undulations for several on-aerodrome facilities. These accuracy requirements are 0.25m (95% confidence interval) for both measurements. This can be readily achieved for computing ellipsoidal heights using appropriate GNSS equipment. However, achieving these accuracy requirements for geoid undulations is more difficult at the present time. Recommended methodologies for determining the geoid undulations are provided below.

C.2.1.3 Because the elevation values of a point may not differ significantly between Ellipsoidal Height, EGM-96 height or any other vertical reference system height, the surveyor should ensure that with each elevation value, the vertical reference frame is stored.

---

## **C.2.2 Method 1**

- C.2.2.1 When a new feature is surveyed using GNSS means, the primary reference frame for the determination of a co-ordinate is the ellipsoid. Some GNSS sensors (or their processing software) have EGM-96 integrated, therefore allowing the direct determination of height above MSL (in EGM-96). When a new survey point is determined by GNSS, the elevation above EGM-96 should be directly determined.
- C.2.2.2 If neither the sensor nor the GNSS processing software have the capability to integrate the EGM-96 undulation for a surveyed point, the ellipsoidal height should be stored for the required point. The geoid undulation should then be determined by interpolation from EGM-96 for the given latitude and longitude of the point.
- C.2.2.3 The same method may also be used for an airborne data acquisition method when the position of the sensor platform is determined by GNSS.

## **C.2.3 Method 2**

- C.2.3.1 A national geodetic body may have scientifically determined a geoid. Provided this geoid is of sufficient accuracy and is referenced to a horizontal reference frame which allows transformation to WGS-84/ITRF without a loss of accuracy, then, for given values of the latitude and longitude of a point, the geoid undulation should be interpolated directly from the data.
- C.2.3.2 The geoid model used should be published by the AISP to allow a transformation to EGM-96 or any other vertical reference frame.

## **C.2.4 Method 3**

- C.2.4.1 If a national / regional levelling system is free from limiting systematic biases, and the offset between the national tide gauge datum and the geoid is known ( $\Delta h$ ), then geoid undulations should be computed by measuring the height of a point above the levelling datum ( $H$ ) and the ellipsoid ( $h$ ). The geoid undulation at that point is then given by the relationship:
- $$N = H - h + \Delta h$$
- C.2.4.2 A realistic estimate of the quality of the heighting network should be obtained from the relevant authorities prior to carrying out the survey work. The accuracy of the heighting network should be documented, together with the data set, as metadata.
- C.2.4.3 The method should only be used when the benchmark values are known with sufficient accuracy.

## **C.2.5 Deriving Elevation Information from Existing Sources**

- C.2.5.1 Some of the elevation information does not have very stringent quality requirements (DME, minimum altitudes). In many regions, Digital Terrain Models (DTM) exist which may be used for deriving the elevation information. The accuracy of the DTM should be at least 1.5 times higher than the data quality requirement of the required feature. The resolution of the DTM should be adequate for the topography to ensure that the highest elevation of the real world is maintained in the digital data set.
- C.2.5.2 The DTM should be available in the same horizontal reference system as the required feature.
- C.2.5.3 For linear or polygonal features, the elevation information should be derived by determining the highest value within the area of interest. For point features, the potential horizontal displacement between the two data sets should be taken into account.



## **C.3 Resources**

### **C.3.1 Useful Websites**

- The NASA Goddard Space Flight Center (GSFC) and National Imagery and Mapping Agency (NIMA) Joint Geopotential Model EGM96<sup>47</sup>;
- The EGM 2008<sup>48</sup>;
- EVRS website<sup>49</sup>.

---

<sup>47</sup> <http://cddis.nasa.gov/926/egm96>.

<sup>48</sup> <http://earth-info.nga.mil/GandG/wgs84/gravitymod/egm2008>.

<sup>49</sup> <http://www.bkg.bund.de/geodIS/EVRS>.

## **Annex D MONUMENTATION**

### **D.1 Monumentation Types - General**

- D.1.1 Where survey markers are installed, they should be of a type appropriate to the task, and to the surface and ground beneath it.
- D.1.2 Designs of suggested survey markers are shown in this section, but other appropriate types of marker may be used.
- D.1.3 Survey markers should be durable (robust) and locally stable so that their position does not change over seasons or years.
- D.1.4 Survey markers should be secured against accidental destruction by self-evident marking.

## D.2 Survey Monumentation - Type 1

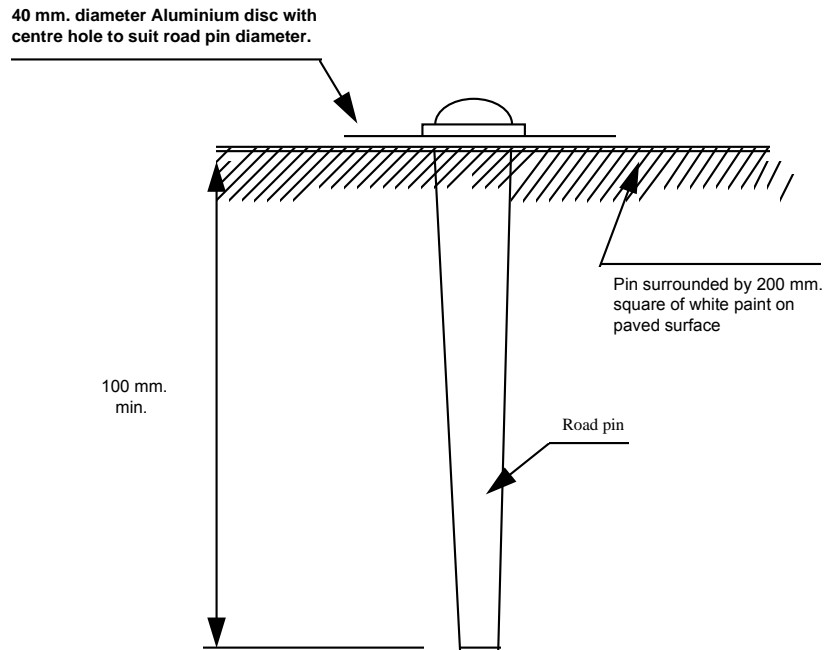

CROSS SECTION  
FULL SIZE

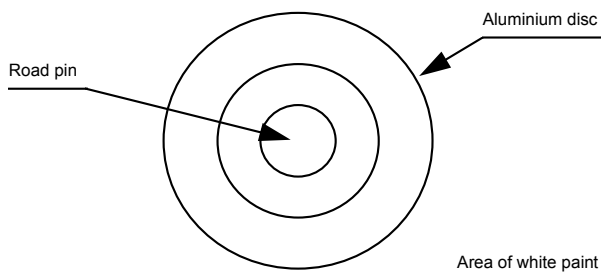

PLAN  
FULL SIZE

### D.3 Survey Monumentation - Type 2

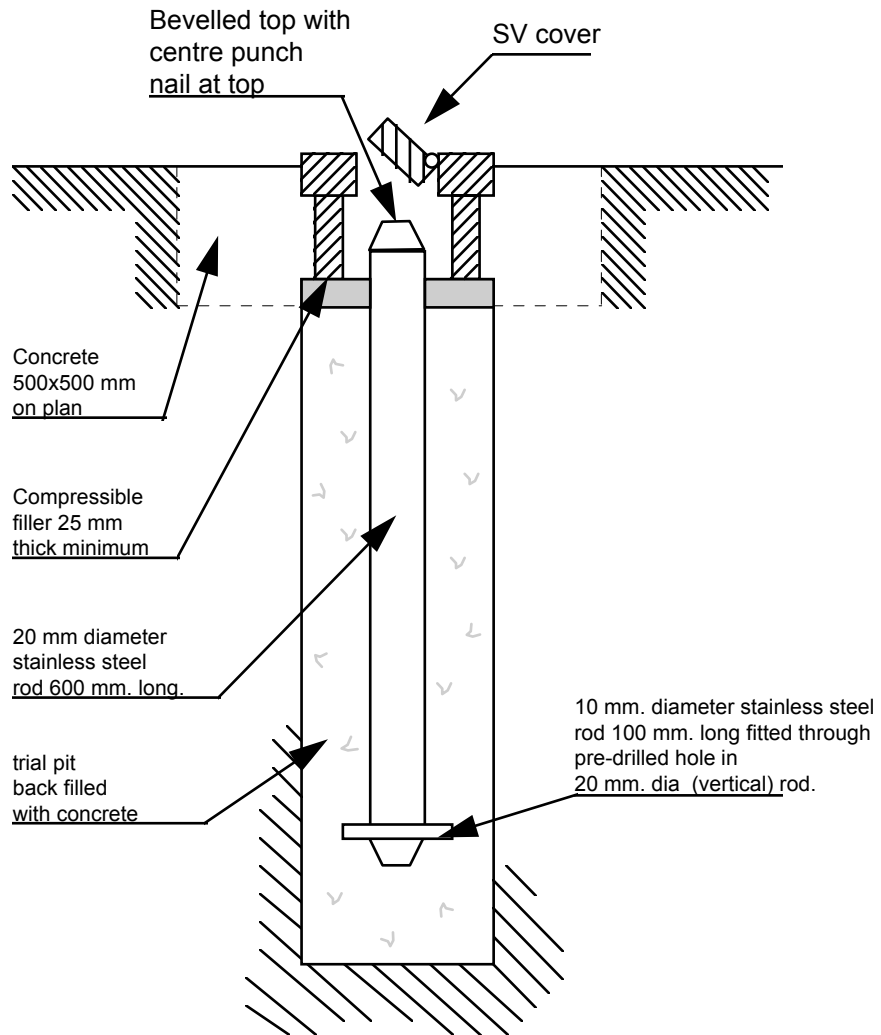

## D.4 Survey Monumentation - Type 3

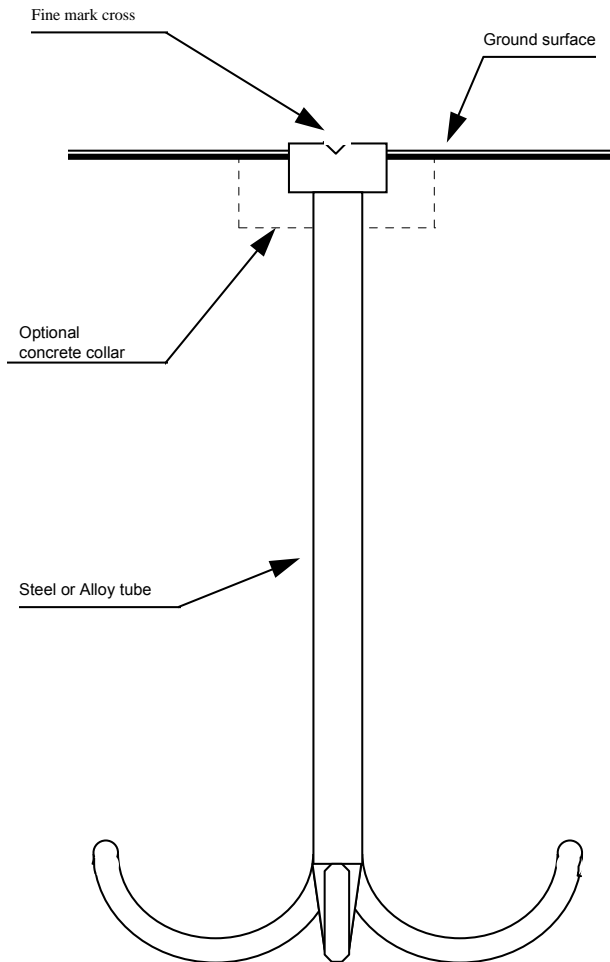

Length to be agreed according to ground conditions.  
The illustration is diagrammatic only and is not intended  
to refer to any particular proprietary type.

## **D.5 Example Numbering System for Survey Markers**

D.5.1 Each survey control point which forms part of the aerodrome survey control network should be marked in the field with a unique identification number.

D.5.2 The system of numbering should include the ICAO aerodrome identifier and the station identifier.

Note: Although the aerodrome identifier will be the same for each station at that aerodrome, and, therefore serve no local purpose, its inclusion is important for identification purposes in digital data sets.

D.5.3 Station identifiers, whether they are alphabetic or numeric, should be assigned chronologically upon the construction of the station.

D.5.4 Whilst numbering systems will vary from State to State, it is important that each system includes a means whereby the stations are not confused with other surveys which may be conducted at the aerodrome.





Note: A simple consecutive numbering system alone, without other identifiers, would not be suitable.

## Annex E DESCRIPTION OF AIRPORT FACILITIES

### E.1 General

- E.1.1 This Annex standardises the determination of threshold points and nav aids for survey purposes. The illustrations contained within this Annex indicate the planimetric position of the points that should be surveyed.
- E.1.2 Where the location of the actual threshold is not known and embedded threshold lights do not exist, then the most appropriate diagram should be selected to indicate the point surveyed.
- E.1.3 Where none of the diagrams included in this Annex are appropriate, a new diagram should be prepared, showing the actual arrangement of markings and the point selected for survey.
- E.1.4 Wing-bar threshold lights and lights installed ahead of the runway hard surface should have no direct survey status with respect to thresholds.
- E.1.5 Points other than the ones mentioned on the figures may need to be surveyed as a result of specific national specifications or applicable standards. Where such requirements exist, the survey records should provide clear information about the points surveyed, for example, through the use of diagrams similar to those shown in this Annex, identifying what has been surveyed.

### E.2 Legend

	Runway centre line
	Point(s) to be surveyed
	Auxiliary line
	Runway and taxiway edge

**E.3 Threshold Marking Example - Type 1**

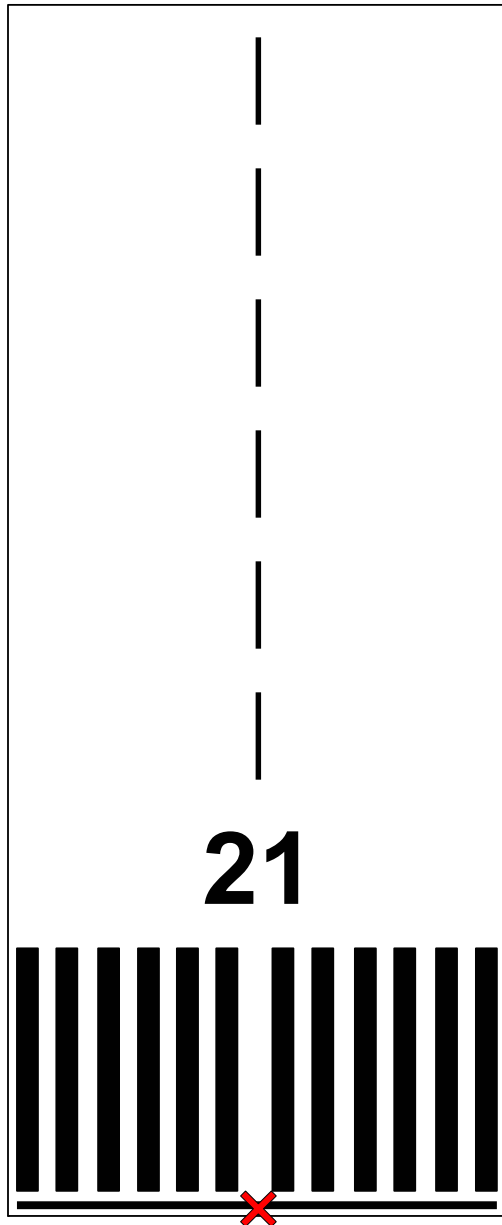

Note: Illustration of normative requirement DO-SVY-740 and following (“regular” threshold, precision approach runway)



**E.4 Threshold Marking Example - Type 2**

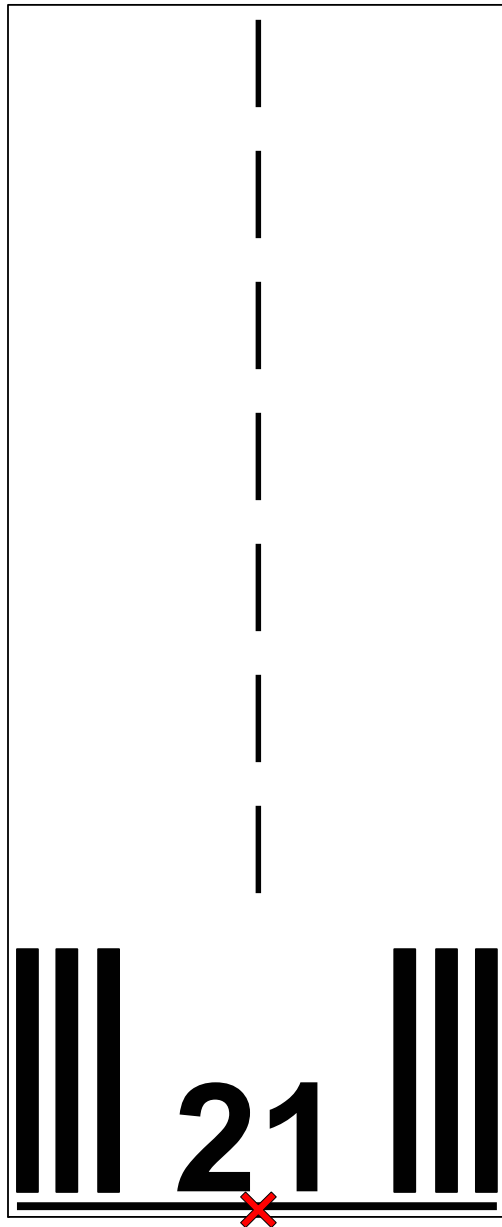

Note: Illustration of normative requirement DO-SVY-740 and following (“regular” threshold, non-precision approach runway)

## E.5 Threshold Marking Example - Type 3

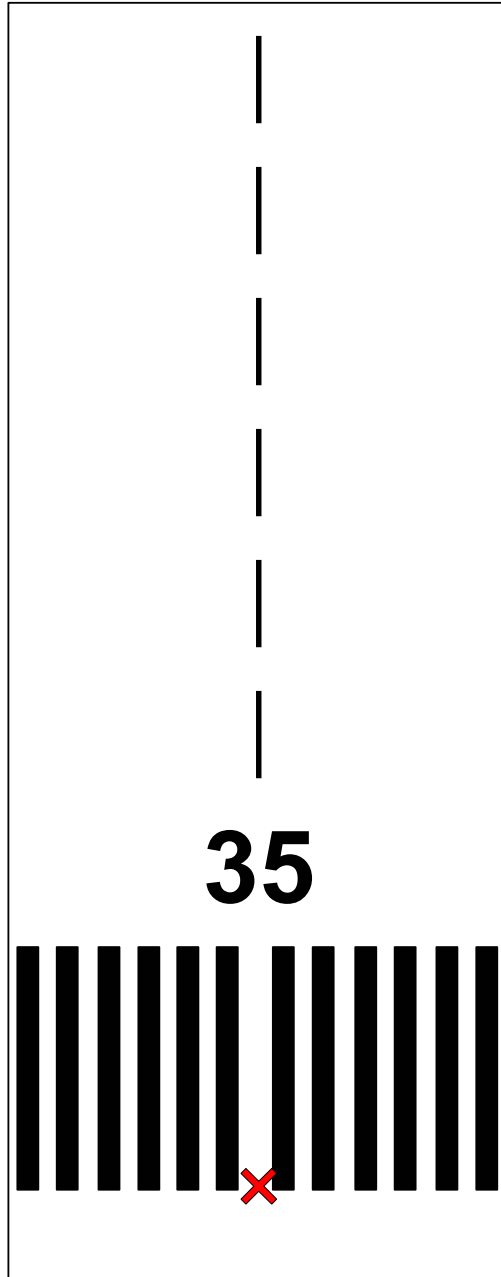

Note: Illustration of normative requirement DO-SVY-740

**E.6 Threshold Marking Example - Type 4**

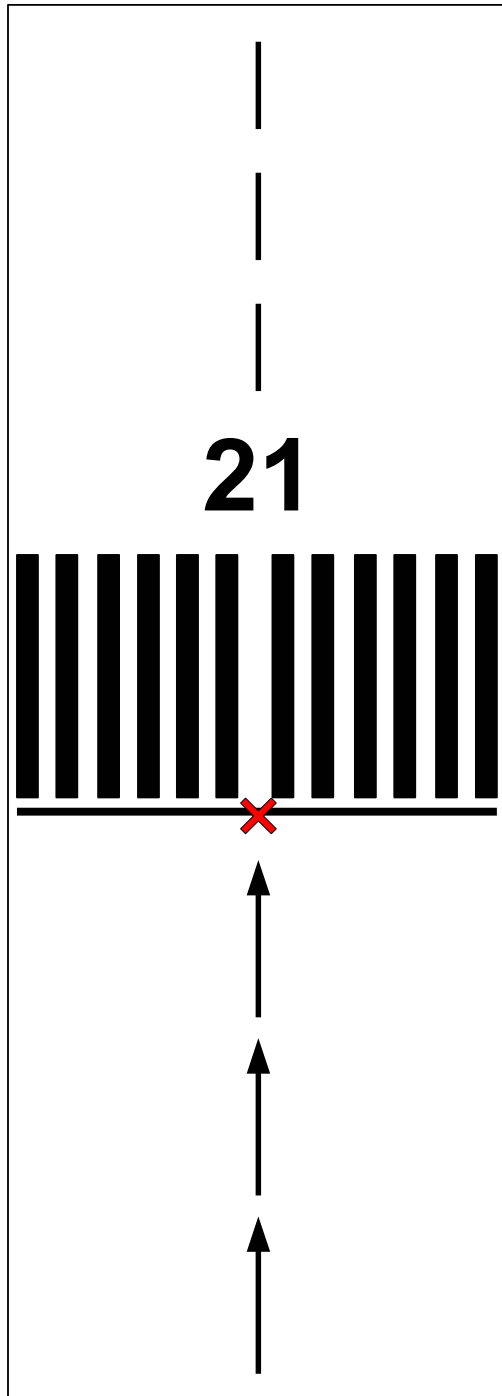

Note: Illustration of normative DO-SVY-740 (displaced threshold)

**E.7 Threshold Marking Example - Type 5**

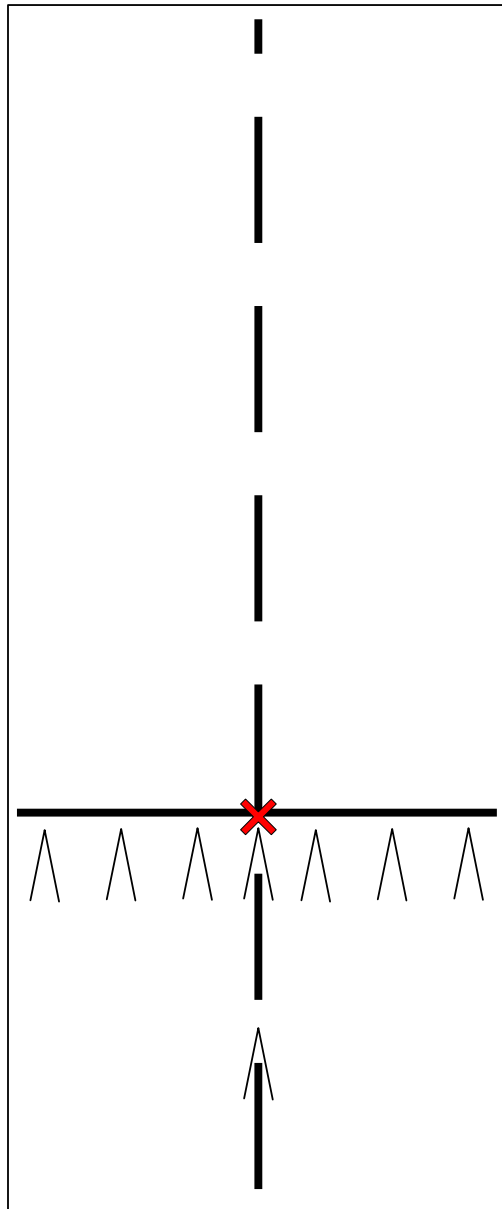

Note: Illustration of normative DO-SVY-740 (temporarily displaced threshold)

## E.8 Runway Centre line with Turnpads

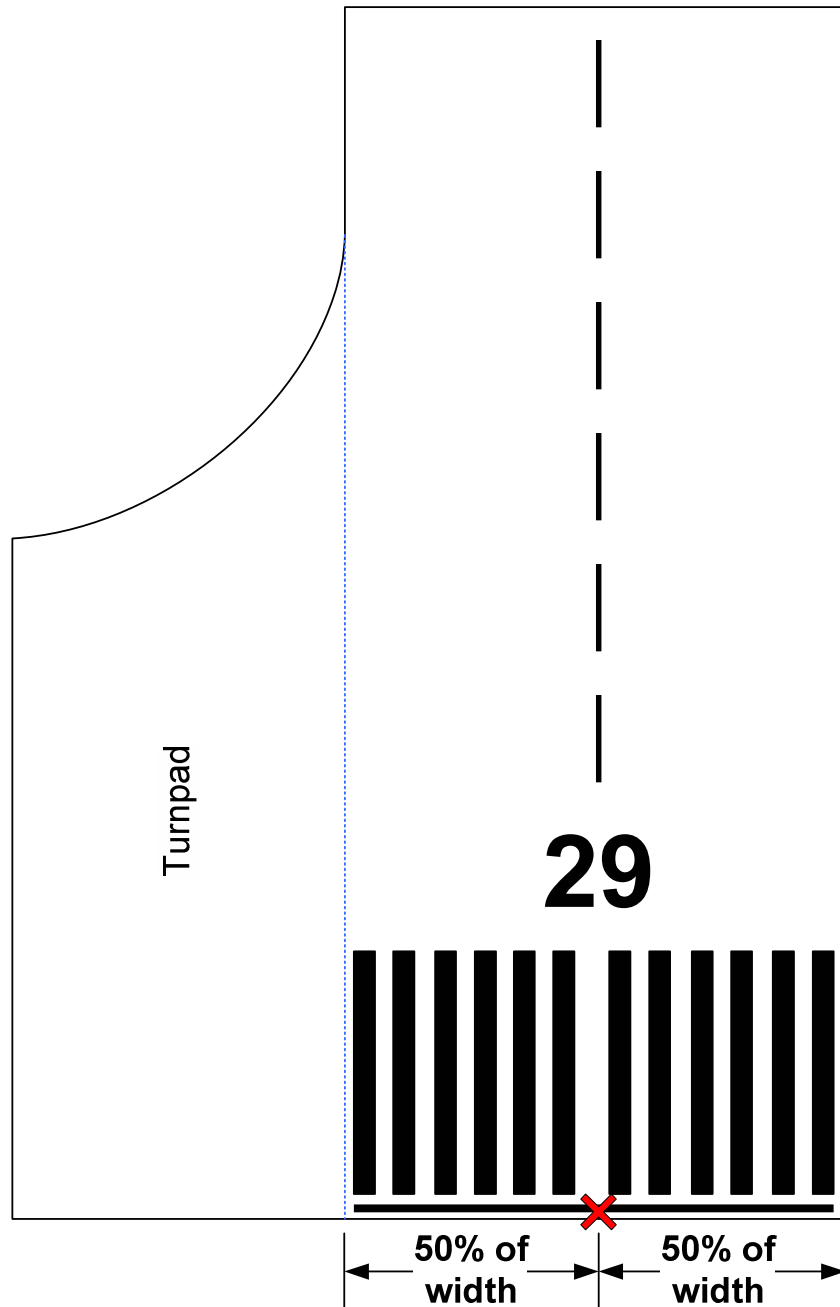

Note: Illustration of normative requirements DO-SVY-720 and DO-SVY-730

### E.9 Intermediate Holding Positions and Stop Bars

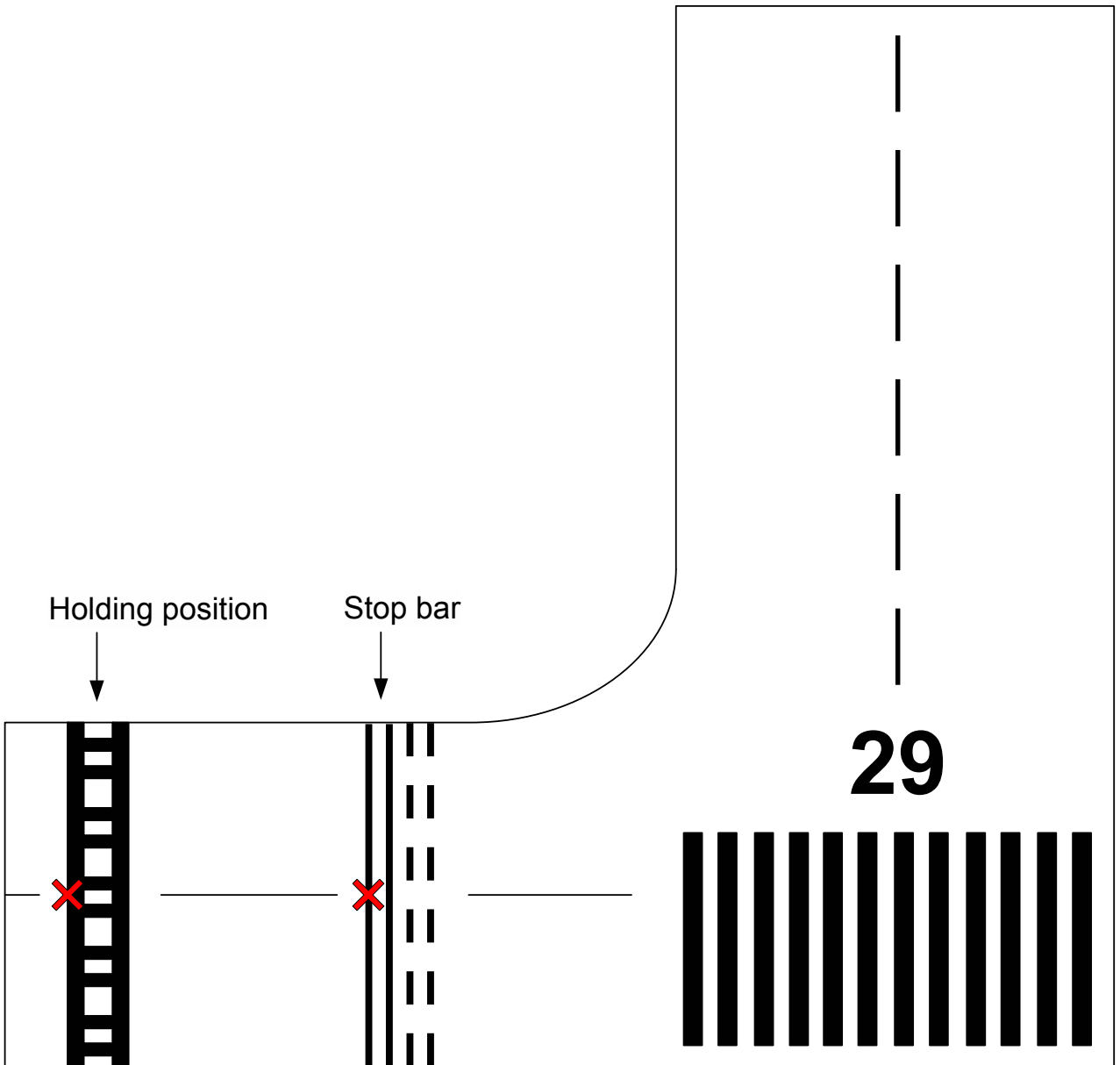

Note: Illustration of normative requirement DO-SVY-1060

### E.10 Runway Distances

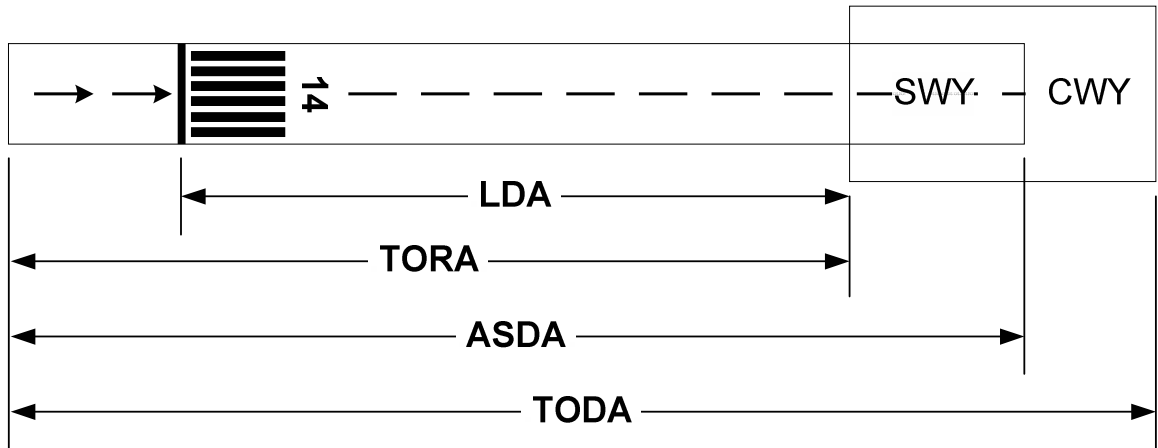

Note: Illustration of the various distances as defined in DO-SVY-910

### E.11 Co-linearity testing

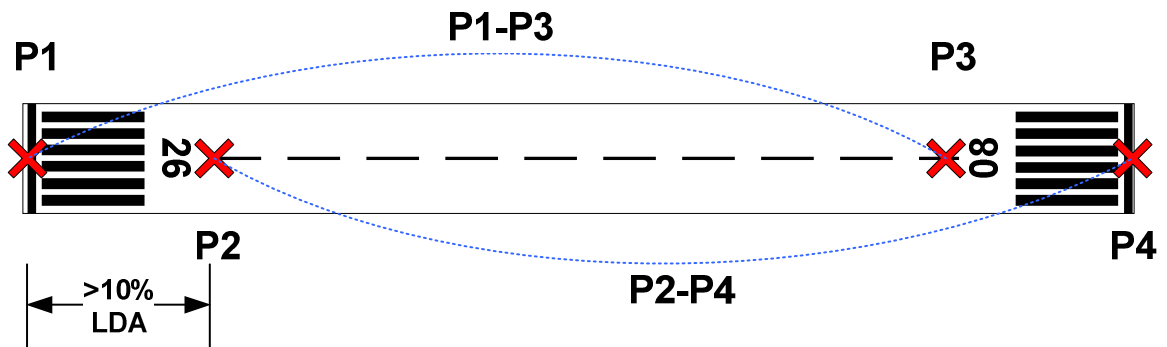

Note: Illustration of the co-linearity testing as defined in DO-SVY-830

## E.12 Taxiway Markings

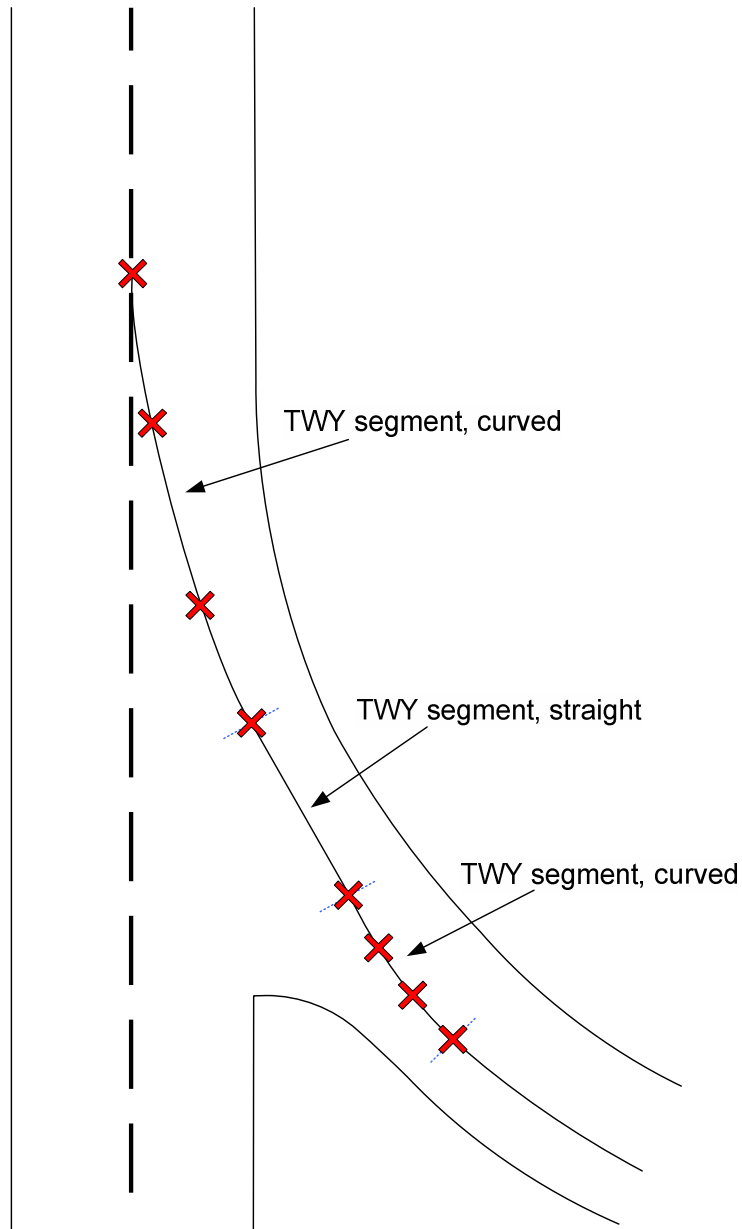

Note: Illustration of normative requirements DO-SVY-960 ff.



**E.13 Taxiway on Runway Marking**

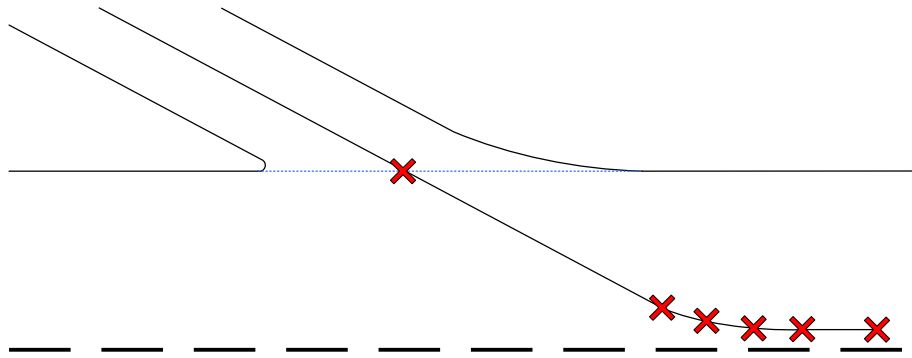

---

Note: Illustration of normative requirement DO-SVY-1050

**E.14 ILS Localizer (Example)**

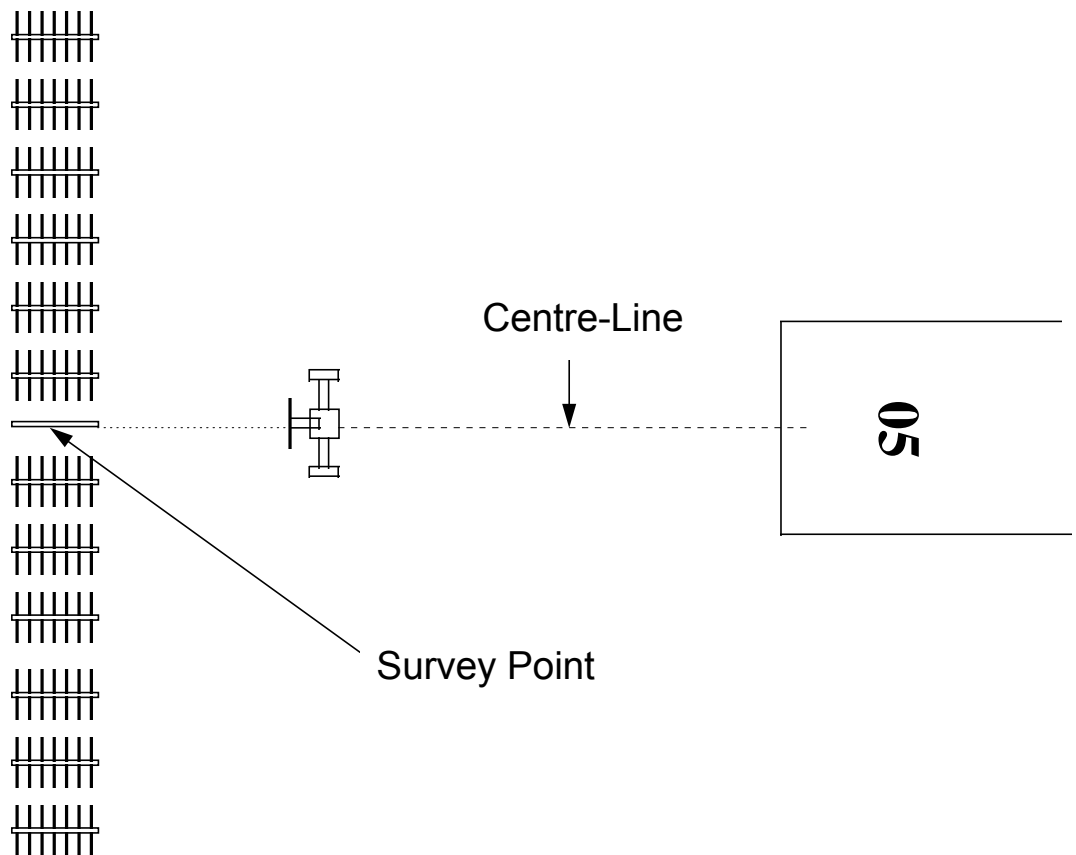
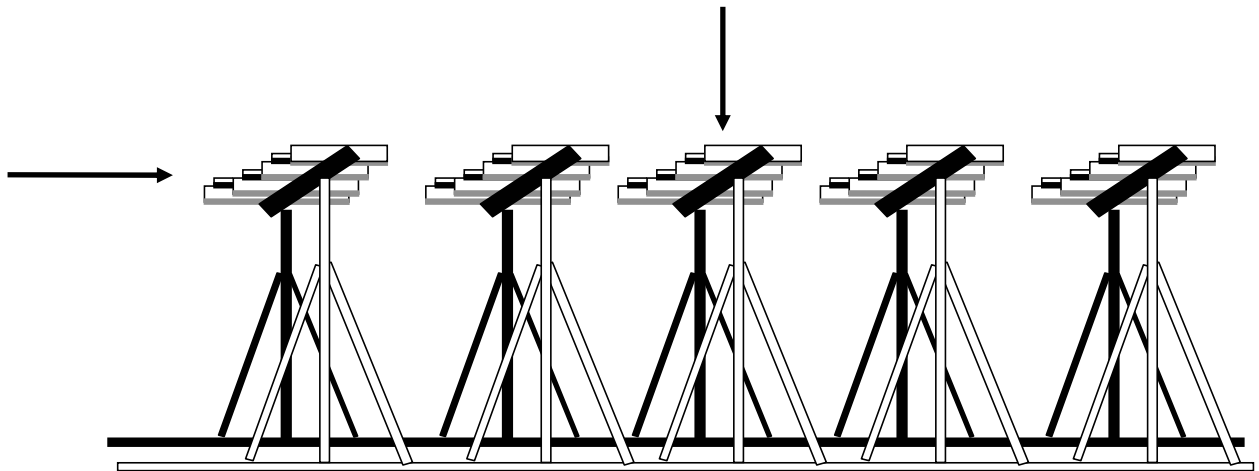

Note: Illustration of normative requirement DO-SVY-660

**E.15 ILS Glide Path (Example)**

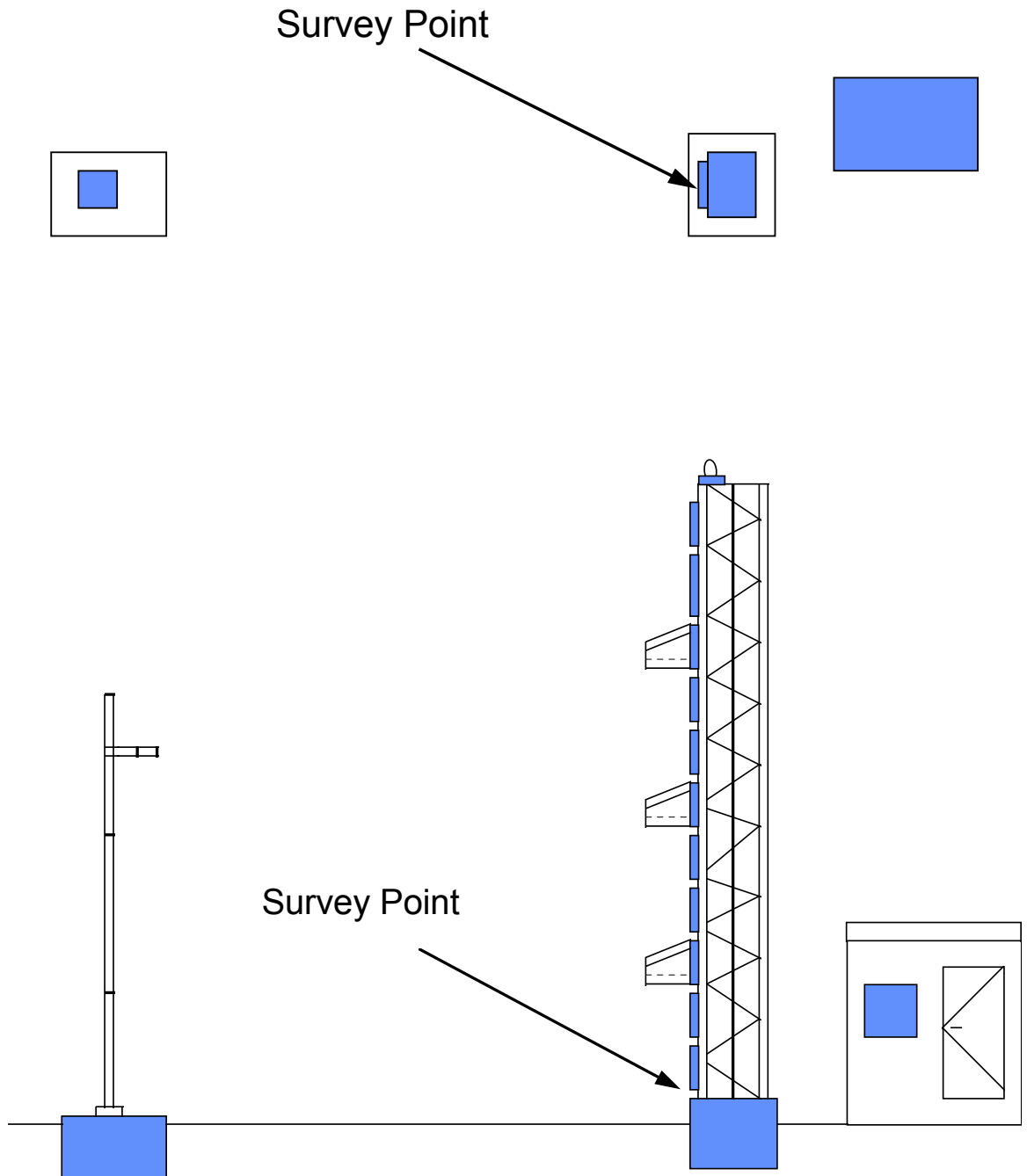

Note: Illustration of normative requirement DO-SVY-660

**E.16**    **MLS Azimuth (Example)**

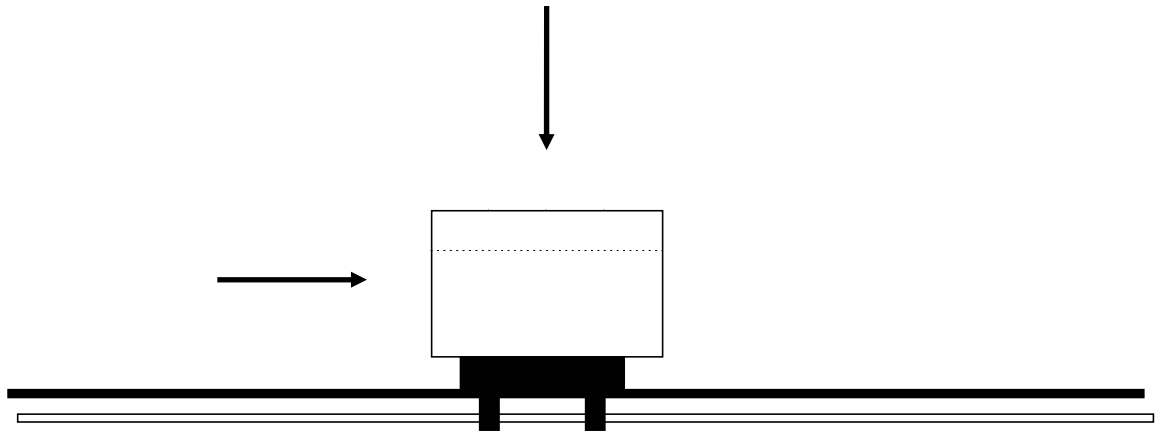

Note: Illustration of normative requirement DO-SVY-660

**E.17      MLS Glide Path (Example)**

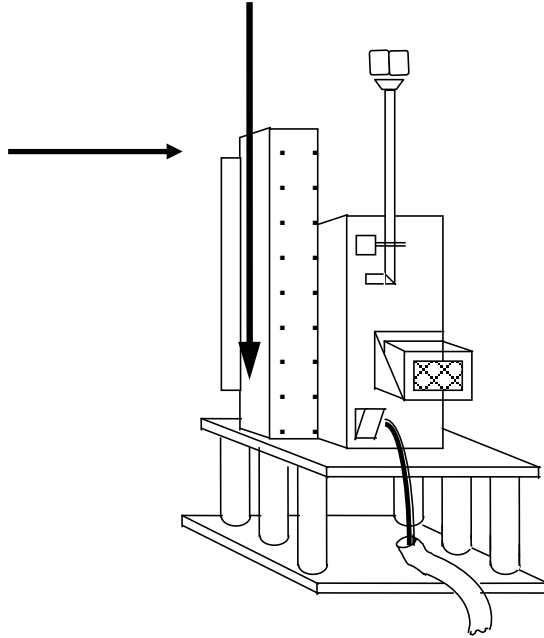

Note: Illustration of normative requirement DO-SVY-660

**E.18 VOR/DME (Example)**

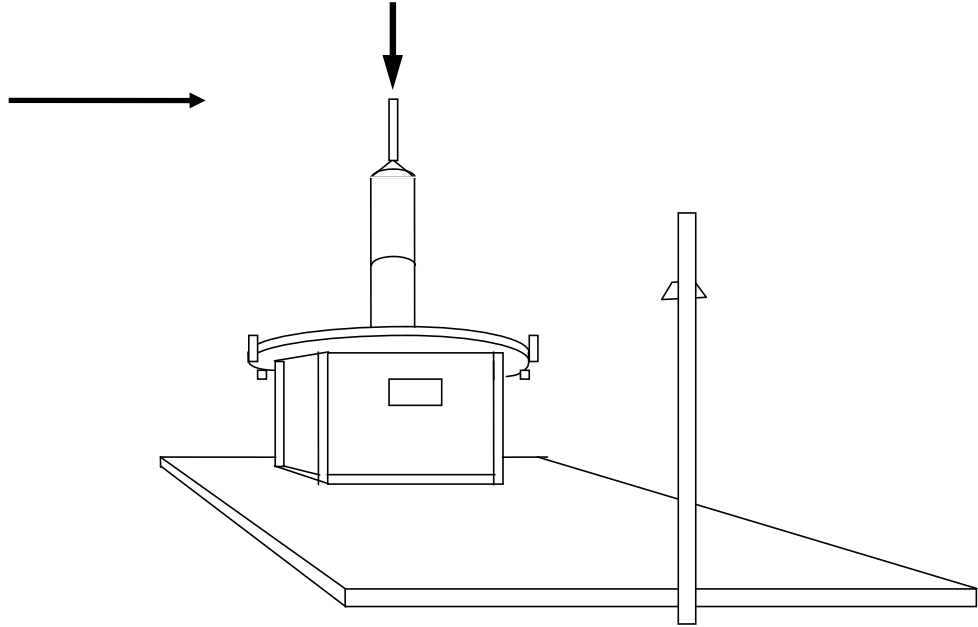

Note: Illustration of normative requirement DO-SVY-680

**E.19 DVOR/DME (Example)**

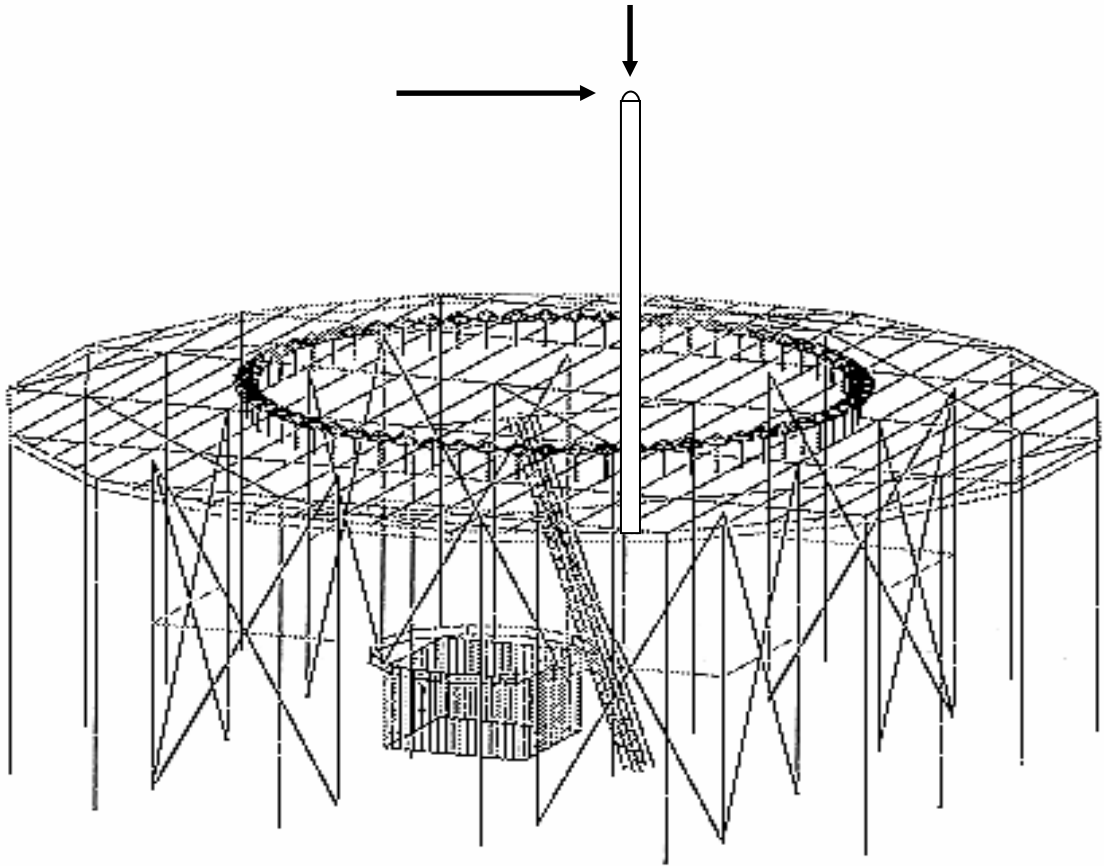

Note: Illustration of normative requirement DO-SVY-700

**E.20 TACAN (Example)**

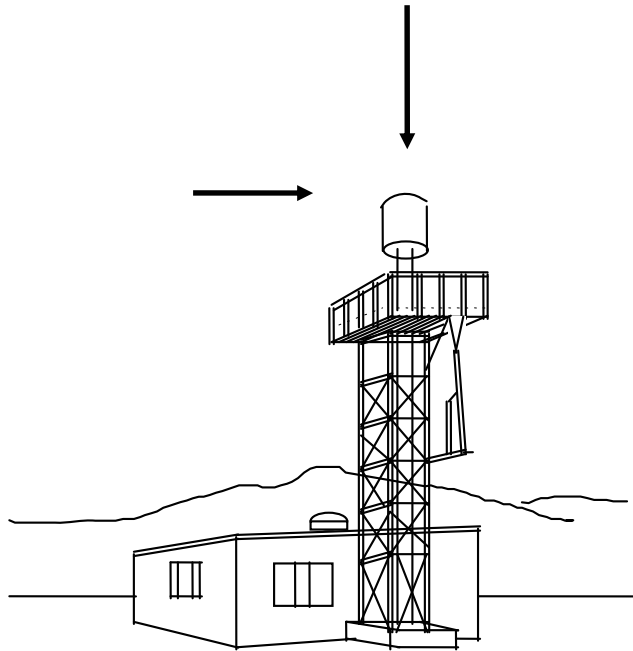

Note: Illustration of normative requirement DO-SVY-660



**E.21 NDB, Locator (Example)**

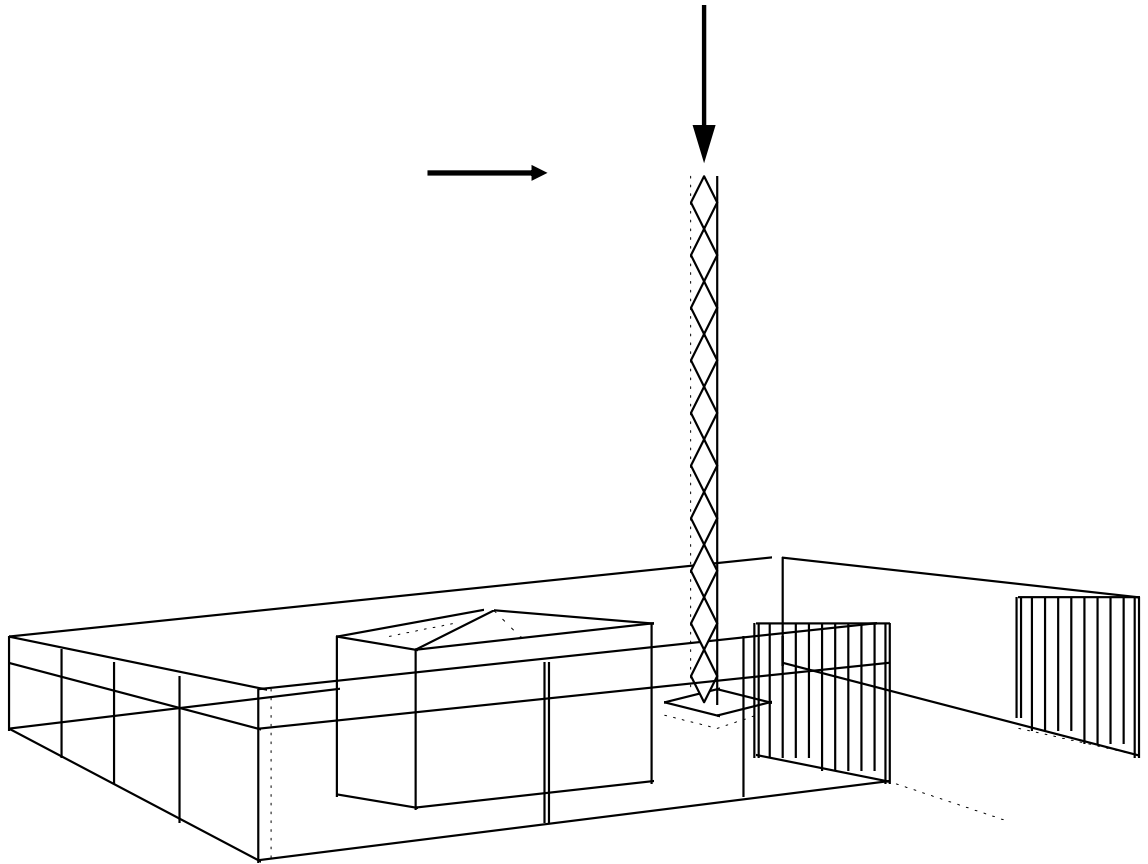

Note: Illustration of normative requirement DO-SVY-660

## E.22 GBAS Reference Point

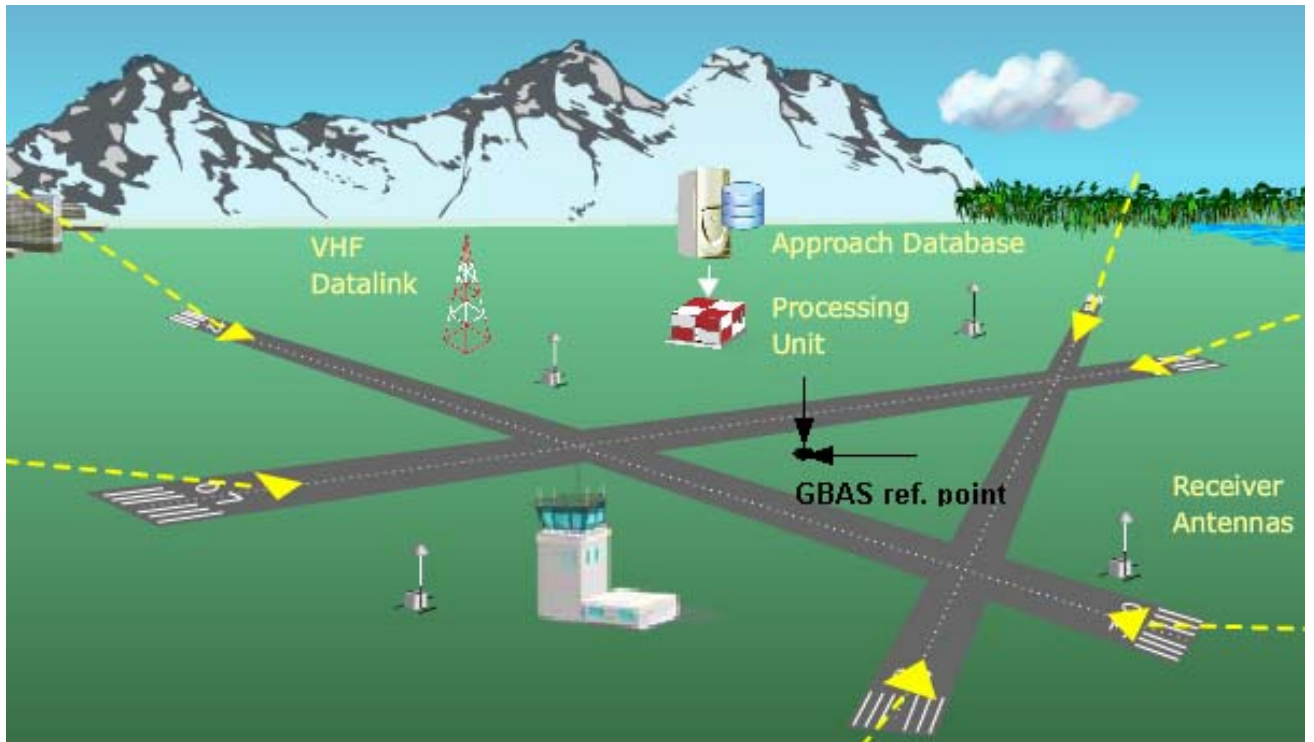





Note: Illustration of normative requirement DO-SVY-670

## Annex F DESCRIPTION OF HELIPORT FACILITIES

### F.1 Heliport Survey Points

- F.1.1 The illustrations contained within this Annex indicate the planimetric position of the points that should be surveyed. It is intended to support the requirements for the survey of features at a heliport in section 2.2.6.9.
- F.1.2 Where none of the diagrams included in this Annex are appropriate, a new diagram should be prepared, showing the actual arrangement of markings and the point selected for survey.
- F.1.3 Points other than the ones mentioned on the figures may need to be surveyed as a result of specific national specifications or applicable standards. Where such requirements exist, the survey records should provide clear information about the points surveyed, for example, through the use of diagrams similar to those shown in this Annex, identifying what has been surveyed.

### F.2 Legend Heliport

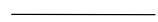
	FATO limits
	Point(s) to be surveyed
	Auxiliary survey point
	Lights
	TLOF Limits

**F.3 TLOF (example)**

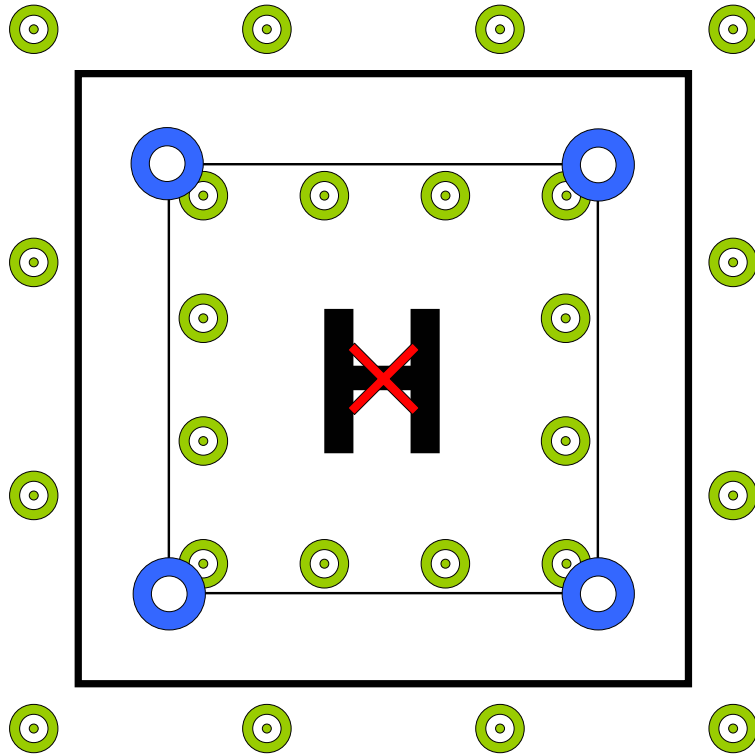

Note: Illustration of normative requirement DO-SVY-1210

F.4 FATO Threshold

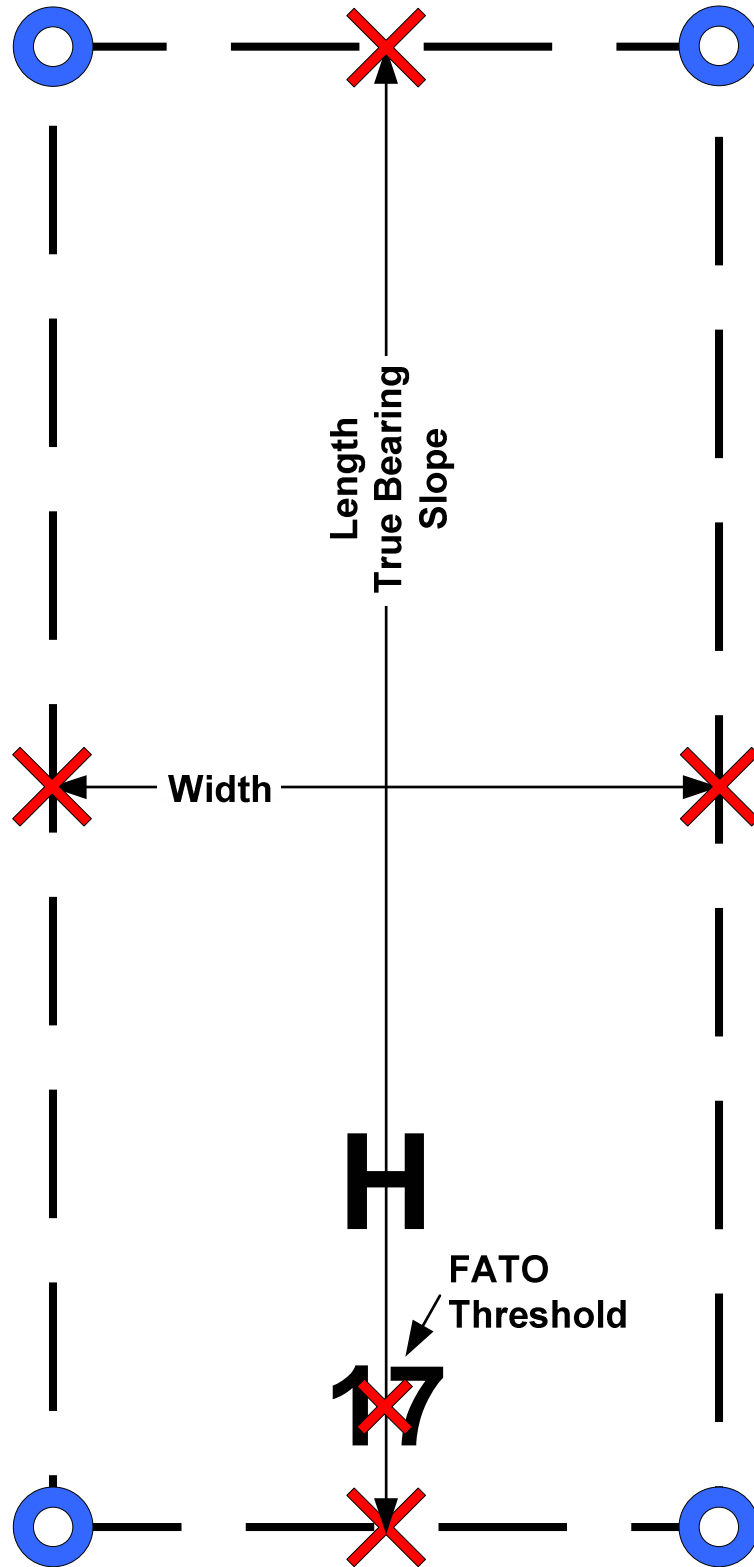

Note: Illustration of normative requirements DO-SVY-1170 and DO-SVY-1180

## F.5 Aiming Point

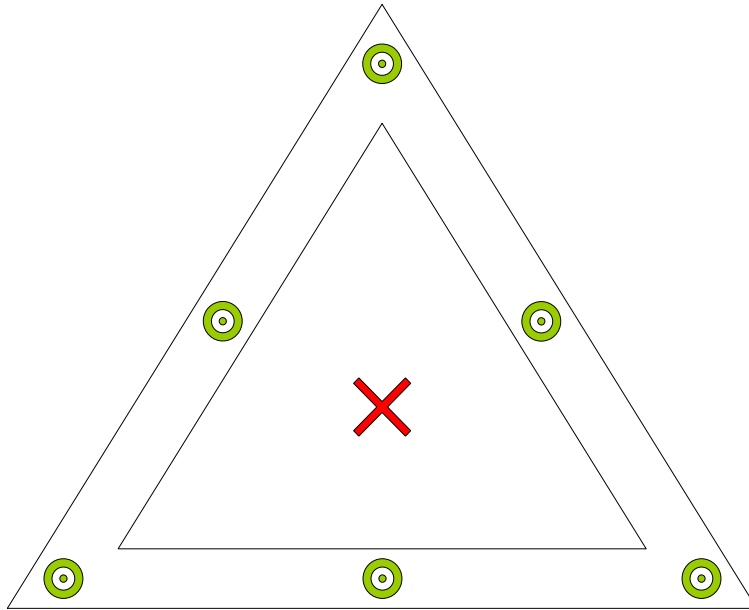

Note: Illustration of normative requirement DO-SVY-1220

## Annex G SURVEY PROCEDURES

### G.1 General

G.1.1 This Annex provides best practice guidance for:

- The establishment of control points (DO-SVY-040);
- GNSS based surveying of facilities (Sections 2.2.1 and DO-SVY-650);
- Reference Systems used during survey;
- Transformation:
  - Horizontal co-ordinates;
  - Vertical / Elevation information.
- Guidance on survey techniques:
  - Conventional Terrestrial Sensors;
  - GNSS;
  - Airborne Laser Scanning (ALS);
  - Photogrammetry.

G.1.2 This information is intended to supplement the requirements stated in section 2.2 of this EUROCONTROL Specification and thereby assist in their interpretation.

### G.2 Reference Systems used During Data Origination

#### G.2.1 Reference Systems for Surveying

G.2.1.1 The relevant ICAO Annexes require that WGS-84 is used as the reference system for air navigation and that, consequently, all co-ordinates are expressed in this geodetic datum. Since access to WGS-84 is difficult to realise with centimetre precision (limited number of reference stations), and because the WGS-84 co-ordinate system is aligned with ITRS, surveying in ITRF can be regarded as identical. However, in many European States access to ETRF and elsewhere to a local (dynamic) geodetic reference frame is much simpler than access to ITRF (i.e. shorter base lines between reference stations, permanent reference network site). Where access to a local frame whose relationship to ITRF is well defined, or can be easily derived (see G.3.2), is easier than surveying directly to ITRF, the survey may be referenced to this frame and the WGS-84 values derived from simple transformation to the ITRF2000 epoch<sup>50</sup>.

G.2.1.2 When more than one co-ordinate is used for derived or calculated data (two runway thresholds for the runway direction), it should be ensured the all co-ordinates were surveyed or re-surveyed against the same frame epoch to minimise potential loss of accuracy due to drifts.

G.2.1.3 At least every five years, the co-ordinates of any surveyed, derived or calculated points should be transformed to the ITRF epoch. The ITRF epoch is recommended for use in air navigation to support a homogeneous and consistent reference frame.

---

<sup>50</sup> Alternative reference frames must be based on a dynamic model which takes into account the tectonic shift. Stations in that frame must also have co-ordinates defined in ITRF or in a continental reference frame, such as ETRF.

## **G.2.2 Reference System Used During Post-processing and Interpretation**

- G.2.2.1 In many data origination processes, it is beneficial to use a planar Co-ordinate Reference System (CRS) instead of ellipsoidal co-ordinates. One disadvantage of planar CRS is that by transforming and reverse transforming co-ordinates, the accuracy of co-ordinates is degraded. The impact is worsened when a map projection based on a different datum is used. Therefore, only UTM should be used when a planar CRS is utilised in the data origination process.
- G.2.2.2 UTM is a planar CRS which can be used everywhere in the world. As it is based on the ellipsoidal shape of the earth (ITRF), the transformation between UTM and ITRF should not significantly impact the spatial accuracy. However, it is recommended that the accuracy of the transformation is validated by conversion and reverse conversion of co-ordinates, taking into account the deviation in the accuracy estimate.
- G.2.2.3 Where at least one process in data origination is performed in UTM, the CRS used in each process should be documented, together with the data transformations applied in the metadata (as part of the lineage information).
- G.2.2.4 Co-ordinates expressed in UTM should always include the grid zone to ensure the unambiguous description of a position.

## **G.3 Transformation**

### **G.3.1 Migrating from Existing ETRF Co-ordinates to ITRF2000**

- G.3.1.1 Because the relationship between the ITRF and ETRF frames is well established, the migration to ITRF can be managed relatively easily, and can be achieved with sufficient accuracy, on the basis of a transformation alone. The transformation parameters relating ETRF to the required ITRS realisation (currently ITRF2000) are published on an annual basis. An existing set of ETRF co-ordinates should be transformed to ITRF2000 simply by applying the requisite parameters.

### **G.3.2 Migrating from Local Co-ordinates to ITRF2000**

- G.3.2.1.1. Where no transformation (including transformation parameters) of a local co-ordinate frame to ITRF2000 is published by the National geodetic agency, a local transformation should be considered for an initial conversion to ITRF co-ordinates using the GNSS surveying technique, at known control stations (covering the area under consideration), to obtain ITRF co-ordinates. Since these control stations are known in the local reference frame and in ITRF, two sets of co-ordinates for identical stations exist. These should then be used to determine the datum parameters required for the Helmert Formula. At least three known control stations have to be surveyed by GNSS in order to obtain additional ITRF co-ordinates necessary for determining all seven Helmert transformation parameters (using the Inverse Helmert Formula). For more reliable results (i.e. minimising the impact of the torsion in the local system), it is recommended that as many common points as possible are used to obtain the best estimate of the parameters by using the least squares method.
- G.3.2.1.2. When such a transformation is used, it must be assumed that the lineage information for the original data origination is not provided and hence the quality requirements are not fulfilled. Deviation from the required quality level should be reported and documented in the metadata.



## **G.3.3 Migrating from Existing Local Heights to EGM-96**

### **G.3.3.1 Migrating using a Transformation Formulae**

G.3.3.1.1. In many States, a new vertical reference frame has been established, together with new horizontal, GNSS-based reference systems. Since ellipsoidal heights are not useful in daily applications, the vertical reference frames are usually either normal or orthometric heights (see section C.1). The geoids or quasi-geoids of such vertical reference systems are not referenced to a global ellipsoid but to a local, best-fitting ellipsoid. Therefore, geoid undulations in local height systems can differ a lot from the EGM-96 value at the same location. To transform local heights with known (quasi-)geoid undulations to EGM-96, the following process should be applied: First the elevation information in the local system needs to be reduced to heights relative to the local ellipsoid. Then a transformation of the horizontal frame from local to ITRF should be applied. Finally, the geoid undulation for each horizontal co-ordinate should be determined using EGM-96 which in addition to the ellipsoidal heights, results in the correct height value relative to MSL.

### **G.3.3.2 Migration Using Control points**

G.3.3.2.1. Where no transformation formulae are available, a transformation using control points (as described in section G.3.2) may be considered. The method can be inaccurate if, within the area of interest, the geoid undulation varies a lot. Typically, for the extent of an aerodrome and its vicinity (obstacles), the impact should be below the accuracy requirements of aeronautical data.

G.3.3.2.2. When such a height transformation is performed, it must also be assumed that the lineage information for the original data origination is not provided and hence the quality requirements are not fulfilled. Deviation from the required quality level should be reported and documented in the metadata.

## **G.4 Establishment of Control points**

G.4.1 The determination of a co-ordinate using GNSS is regarded as a well-established technique. The aim of this section is to provide recommendations for some aspects of the GNSS survey which are of special relevance to aviation data origination. These aspects are:

- Measuring connection to a 3D geodetic reference frame;
- Choice of siting for control stations;
- Redundancy;
- Backing up data in RINEX format;
- Computation.

### **G.4.2 Measuring Connection to a 3D Geodetic Reference frame**

G.4.2.1 Under the umbrella of EUREF sub-commission of the International Association of Geodesy (IAG), permanent reference stations are operated by national geodetic agencies throughout Europe. The reference stations are located at points that have publicly available ETRS89 co-ordinates (or co-ordinates of a national reference system which are closely linked to ETRS89). Data from these stations is often freely available via the Internet. Using data from such stations, in conjunction with static observations at a new point, is a relatively straightforward and a very cost-effective method for determining ETRS89 co-ordinates.

- G.4.2.2 When the distance between a permanent operating reference station is less than 50km away from the point to be surveyed, this station should be used as a reference. Where the closest point is more than 50km away but a reference point in ETRS89 is available within the 50km, this “passive” reference point should be used for the establishment of a control point.
- G.4.2.3 Where the distance between the aerodrome and the closest permanent operating reference station is less than 20km or where data from a virtual reference station<sup>51</sup> can be downloaded, survey points may be determined directly and not by using a geodetic control network.
- G.4.2.4 Once ETRFxx<sup>52</sup> co-ordinates of a suitable quality have been computed, these should be transformed to ITRF2000 values using the published European Reference Frame (EUREF) co-ordinate transformations.
- G.4.2.5 If connection to the ETRS frame cannot be accomplished then the latest realisation of the ITRF series should be used. This should be via the core IGS/ITRF stations themselves, or via national sub-networks that have demonstrably good connections to the ITRF. Again, newly originated co-ordinates should be transformed to ITRF2000 using the published co-ordinate transformations.
- G.4.2.6 Ties to WGS-84 via ETRS89 should be made directly to points with co-ordinates in ETRS89, provided that these co-ordinates have known and suitable accuracies and that the suitable EUREF transformation set is applied to compute the final ITRF co-ordinates. The recommended procedure is to effect the tie directly to ITRF stations using IGS data products, although this may be technically more challenging due to the density of suitable control stations within Europe, at this time.

### **G.4.3 Site Selection for Control Stations**

- G.4.3.1 The quality of the computed co-ordinates in a GNSS survey should be enhanced by suitable site selection. In general, the fewer the number of obstructions between the station and the skyline, the better the results of the survey. Where the visibility is limited, the use of more than one GNSS should be considered (GPS and GLONASS combined. In the future, the inclusion of GALILEO also).
- G.4.3.2 Another limiting factor on computed precision is the effect of signal multipath. Multipath effects are caused by the signal from the satellite being reflected by objects in the vicinity of the antenna. These reflected signals interfere with the direct signal, distorting the computed range between the antenna and the satellite. Multipath effects should be avoided by careful selection of the station’s position. In general, survey crew personnel should take not of the following:
- Locations where reflecting surfaces are above the level of the antenna should be avoided; this can include wire mesh fences and anything that absorbs water, such as wood;
  - Use an antenna with a choke ring or ground plane to reduce multipath effects.

---

<sup>51</sup> A virtual reference station is computed based on the data of different permanent operating reference stations in the surrounding area. The simulation usually takes into account complex models of the atmosphere, allowing the accuracy of the point determination to be of the same magnitude as a real reference station.

<sup>52</sup> The ‘xx’ stand for an epoch of ETRF, such as ETRF89, ETRF90, etc.

- G.4.3.3 If it is not practical to site a station in a benign multipath environment then some form of multipath assessment should be carried out prior to establishment of a network control station.
- G.4.3.4 Some consideration should also be given to potential radio-frequency interference. This is particularly problematic at microwave communication antenna stations. The jamming caused at such locations can be intermittent depending on whether the station is transmitting or not. Therefore, it is possible that testing of GNSS signal acquisition at the station could be successful at one time, and a complete failure at others. In general, any station locations near to microwave transmitters should be avoided.
- G.4.3.5 Whilst using L1/L2 GPS dual-band receivers on airfields with military primary radars, interference with the L2 frequency may be experienced. From experience of operating in such environments, physical screening of the GPS receiver from the direct radar signal may be necessary. Where this cannot be achieved by interposing airport structures, buildings etc., it has been found that the use of straw bales has proved effective.
- G.4.3.6 An azimuth-elevation skyline survey should be carried out at a station as part of a station assessment exercise. Most commercial GNSS processing software has functionality that allows the user to input azimuth-elevation data, and, in conjunction with GNSS almanac data, assess the satellite availability at a station as a function of time.
- G.4.3.7 Network control points should always be sited in secure locations to avoid the risk of equipment loss and damage to the station monumentation. At the same time, the station should be accessible to the personnel using it, and have suitable skyline characteristics.
- G.4.3.8 Control station monumentation should always be founded on stable ground, preferably such that seasonal variations in temperature and moisture do not adversely affect its position. The ideal ground surface is exposed bedrock. Tarmac surfaces should be avoided.
- G.4.3.9 The suitability of a proposed network control point site should be assessed in terms of:
- Satellite availability;
  - Multipath environment;
  - Radio frequency interference;
  - Security;
  - Access;
  - Stability.

#### **G.4.4 Redundancy**

- G.4.4.1 The following guidance should always be followed when a co-ordinate with a data integrity level of critical is to be surveyed.
- G.4.4.2 When establishing a new control point, at least two independent baselines in the computation of the new station should be used. Whilst GNSS can achieve outstanding results for almost minimal effort, the traditional surveying concepts of independent checking and redundancy should still apply, particularly in order to achieve quality control and the trapping gross errors. Ideally, baselines should be observed on different days, using differing control points, and with a rotation of survey crew personnel.

- G.4.4.3 Each new station should be occupied at least twice, using differing crew personnel on each visit. This helps to trap gross errors in general and in particular the manually derived antenna height.
- G.4.4.4 The free availability of GNSS data from permanent operating reference stations makes it possible to carry out checks on positioning by computing baselines between the new station and points in the national network. Such checks should be used as part of the accuracy assessment of any point which has an integrity level of critical or essential assigned to it.

## **G.4.5 Backing up Raw Measurements**

- G.4.5.1 In the same way that American Standard Code for Information Interchange (ASCII) data is a universal text data format that can be read by almost all computers, there is a universal text-based format for GNSS phase, pseudorange, navigation and meteorological data, known as Receiver Independent Exchange Format (RINEX). Most commercial GPS processing software will enable the user to export their raw GPS data in RINEX format.
- G.4.5.2 All GNSS project data (regardless of reference station or survey station) should be backed up and archived in RINEX format.
- Note: This allows for the independent validation of any GNSS data processing by another agency, and also guards against the proprietary format data becoming unreadable as software versions evolve. RINEX is also the primary means of importing GNSS data into third-party GNSS data processing software.
- G.4.5.3 Total stations provide various interfaces, like customised ASCII or LandXML, for data import and export. All raw measurements from the total station should be archived for possible re-evaluation, if necessary. The format of the data should be documented, together with the measurements.
- G.4.5.4 For all other sensors, the raw data is often stored in a proprietary format, hence raw data should not only be archived but also the appropriate tools should be kept during the lifecycle of the data items derived from the raw data. This may mean that archive versions of tools must be retained beyond their normal operational life.

## **G.5 Guidance on the Application of Different Survey Techniques**

### **G.5.1 Surveying Using Conventional Terrestrial Sensors**

#### **G.5.1.1 Sensor Technique**

- G.5.1.1.1. From the wide variety of sensors for terrestrial surveying, total stations are best suited to the needs of aeronautical data origination due to their capability to support complete digital data chains. Today's sensors are equipped with precise angle and distance measurement systems, two-axis compensators and offer different interfaces for data import and export. The system often provides functions which support increased productivity, such as:
- Direct reflector-less measurement (i.e. without prism) of inaccessible objects;
  - Documentation of each surveyed point by integrated photo camera;
  - Automated target recognition;
  - Integration of base map in control station for direct visualisation of newly acquired features.

- G.5.1.1.2. The functions of a sensor should be evaluated with respect to increased quality (reliability of measurement, detection of gross errors in post-processing, documentation of lineage information, etc).
- G.5.1.1.3. Some vendors combine a total station with GNSS receivers in a terrestrial positioning system. This combination brings several benefits with respect to higher performance in data acquisition and accuracy. However, care should be taken so that the simplicity of measurement does not lead to the reduced attention of the surveying crew. The recommendations from both G.5.1 and G.5.2 (Surveying Using Conventional Terrestrial Sensors and GNSS Surveying of Facilities) should be taken into account when a terrestrial positioning system is used.

### **G.5.1.2 Operational Procedures**

- G.5.1.2.1. The main focus in the preparation of a survey using a total station should be placed on the careful selection of the site. Each site should allow accurate setup, provide good visibility to the features to be surveyed and ensure that the accuracy requirements (combined uncertainties of reference co-ordinates, setup, measurement and transformation) are fulfilled. Interference with vegetation in the line of sight should be avoided.
- G.5.1.2.2. With total stations, various methods for setting up the station have been established, such as Set Orientation, Known Backsight or Multiple Backsights and Resection. The setup method should be determined based on the accuracy requirements, the local circumstances and the availability of accurate and reliable control points.
- G.5.1.2.3. Data origination using a total station should be performed in UTM since the distance measurement is expressed as a length, not as radians (Arc Seconds).

### **G.5.1.3 Quality Control**

- G.5.1.3.1. For ensuring a the achievement of data quality requirements in the conventional terrestrial data acquisition, redundant observations should be measured. Redundant measurements allow a direct calculation of the spatial accuracy of the surveyed object. Besides the accuracy, the real-time quality control should help to determine that the correct feature has been surveyed. Two methods for this are available, in modern systems, from which at least one should be applied:
- a) A base map with existing features can be loaded into the sensor which allows a direct visualisation of newly acquired features;
  - b) Using an integrated camera, the survey point can be documented during data acquisition with a imagery of the relevant area.

## **G.5.2 GNSS Surveying of Facilities**

### **G.5.2.1 Observation Technique Types**

- G.5.2.1.1. There are many methods by which GNSS surveying can be accomplished. The acronyms below may have alternative meanings in some guides/literature, and hence, they cannot be regarded as definitive. The headings followed by (RT) are real-time techniques, that is, the co-ordinates of the point being surveyed are accessible to the surveyor at the time of occupation of the point:
- Relative GNSS (RGNSS) – static relative positioning using phase and pseudorange;
  - Differential GNSS (DGNSS) – broadcast differential pseudorange corrections (RT);

- Kinematic GNSS (KGNSS) – kinematic GNSS positioning using phase and pseudorange;
- RTK GNSS – real-time kinematic positioning using phase and pseudorange (RT);
- Navigation solution – low precision single receiver applications (RT);
- Precise Point Positioning (PPP) – precise point positioning, high precision single receiver applications using post-processing in conjunction with internet data services;
- Regional RTK corrections supplied by service provider (RT);
- Wide Area DGNSS – wide area DGNSS using corrections from networks of receivers, in conjunction with geostationary satellites (such as the European wide EGNOS system) (RT).

### **G.5.2.2 Operational Procedures**

G.5.2.2.1. In pre-survey planning and the establishment of control survey, the availability of satellites throughout the day should be assessed and the Dilution of Precision (DOP) variations that may be encountered should be quantified. Where any real-time kinematic surveys are planned, the planning should encompass the DOP and the availability of satellites, as they generally require a minimum of six satellites to be available. For the availability assessment, the satellite elevation mask angle should be set to 15° above the horizon.

G.5.2.2.2. Most real-time GNSS equipment includes measures of quality that can be accessed in the field. The quality measures, how these have been derived and how they can be used to maintain a certain level of homogeneity in the survey results should be fully understood. Where is a doubt about the reliability of a co-ordinate or a quality measure, raw data should be captured and post-processed.

G.5.2.2.3. Initialisation points for kinematic data chains should always be chosen in areas with low skylines and minimal obstructions. The occurrences of loss of lock or cycle slip both increase the initialisation time necessary and reduce the likelihood of correct integer ambiguity resolution.

G.5.2.2.4. At least one known control point should be occupied in all kinematic surveys (no matter what the accuracy requirements are) as part of the chain of points measured by the roving receiver. This should be the case at both the beginning and the end of a survey.

Note: This procedure is to ensure that no gross error has been made in the antenna height measurement of either the rover or the base station, or in the values of the base station co-ordinates used.

G.5.2.2.5. Kinematic surveys using a roving receiver should generally be carried out in areas of open landscape with a good view of the skyline. In more built-up environments, these techniques can be less reliable and inefficient. In this case, alternative measurement techniques should be considered (for example, using conventional surveying techniques).

G.5.2.2.6. Where single frequency DGNSS equipment is being used, care should be taken that the achievable co-ordinate precision is sufficient for the task.

Note: Typically, code-multipath errors at both the rover and reference receivers can be the major limiting factor. Phase smoothing of the code observations can greatly mitigate these effects, but is not necessarily used by all equipment. These code-multipath effects can vary greatly depending

on the environment of the receiver and, therefore, occupation of a known point in a very favourable multipath environment is not necessarily a guarantee that all points in the chain will meet the required precision. The manufacturer's stated precision of the equipment should be used as a guideline as to the suitability of the equipment.

- G.5.2.2.7. Real-time kinematic surveys are often logged as co-ordinate data only. It is, however, recommended that, if possible, all raw observations should be recorded to enable post-processing and data quality assessment.

### **G.5.2.3 Real-time Quality Control**

- G.5.2.3.1. The quality of GNSS positioning depends upon a number of factors, such as satellite geometry (as typically represented by a DOP value), the number and elevation of satellites, hardware, environmental factors, processing models and accuracy of ephemeris, etc. It is extremely difficult to provide precise guidelines to cover all the possible combinations of these factors. However, modern GNSS equipment provides real-time assessment of data quality and this should be monitored carefully to ensure that specifications are being met. The spatial accuracy of points measured by GNSS should be assessed as part of the data quality evaluation. The number of control points should be chosen based on the integrity level assigned to the newly originated features.

## **G.5.3 Surveying using Airborne Photogrammetry**

### **G.5.3.1 Sensor Technique**

- G.5.3.1.1. Aerial Photogrammetry is a survey technique which has been used for a number of years for fast data acquisition over large areas. The latest development in this field is mainly in regard to digital cameras. Modern digital cameras are equipped with high-resolution, multi-spectral sensors. The sensor system usually comprises a roll-compensation unit and a Positioning and Orientation System (POS), in addition to the camera. The POS consists of a DGNSS and an Inertial Measuring Unit (IMU). The main benefit of the POS is the reduction in the numbers of ground control points needed for the aero-triangulation because the position and orientation of the camera during the data acquisition can be accurately determined.
- G.5.3.1.2. Aerial Photogrammetry can be used to determine the 3D geometry of features. Due to the costs of the mobilisation, the system is typically deployed in the aviation domain for mass data acquisition, such as for terrain data, (re-)survey of obstacles or for Aerodrome Mapping Database (AMDB) creation and update.
- G.5.3.1.3. The most restrictive requirement for obstacle acquisition by Aerial Photogrammetry is the minimum size of the obstacles which have to be captured. To capture very thin objects (e.g. antennae, street lamps, etc), the image scale<sup>53</sup> has to be larger than for traditional survey flights. This requires a lower flight level. With a lower flight level, the resulting spatial accuracy (x, y, z) will be higher than necessary. Obviously, the costs for data acquisition of terrain and obstacle data are higher than for traditional applications.

---

<sup>53</sup> Image scale = flight height / focal length, e.g. camera lens with 15cm focal length and a flight height of 1,200m above ground level will lead to an image scale of 1:8,000. With these parameters, a spatial accuracy of 15cm vertical and 5cm horizontal can be achieved.

### **G.5.3.2 Operational Procedures**

- G.5.3.2.1. The quality of the acquired data is largely impacted by the preparation for data acquisition and the flight planning. The flight planning has to consider several factors and it should be conducted carefully to ensure that the resulting quality characteristics meet the requirements (completeness, spatial accuracy). The flight planning should be independently validated. The following parameters should be taken into account:
- Interference with air traffic at the airport which needs to be surveyed;
  - Optimal flight season and time with respect to sunlight and shadow length, and predicted quality of GNSS (satellite constellation, see section G.5.2.2);
  - Optimal flight season with respect to foliage condition (leaf-on season) for better reconnaissance of top of canopy;
  - Required resolution and spatial accuracy requirements;
  - Focal length;
  - Longitudinal and lateral overlap;
  - Set up of reference station for differential GNSS.
- G.5.3.2.2. During the data acquisition, the operator should ensure that the parameters determined in flight planning are maintained. The operator should also monitor the real-time solution of the POS to detect anomalies as quickly as possible.
- G.5.3.2.3. The processes following the calculation of the POS solution rely on a planar coordinate system. All processing steps should therefore be conducted in the appropriate UTM grid cell.
- G.5.3.2.4. The imagery collected with Aerial Photogrammetry for obstacle mapping allows the extraction of a DTM. If a Digital Surface Model (DSM) is generated using image correlation techniques, then the DTM has to be extracted from the DSM. DSM correlation is a vulnerable technique because in low contrast areas, the algorithms often fail to determine the elevation accurately. It should be ensured that sufficient control points are available for quality evaluation of the spatial accuracy.
- G.5.3.2.5. Feature extraction (obstacles or AMDB features) is based on stereo-pairs. For obstacle extraction, the Obstacle Data Collection Surface (ODCS) should be made available in stereo view to support the operator. The ODCS shown in the system facilitates the differentiation of objects penetrating the ODCS from other objects.

### **G.5.3.3 Quality Control**

- G.5.3.3.1. The spatial accuracy of the geo-referenced images should be estimated in the bundle block adjustment. One benefit of the estimate is that it is available for the entire area, with overlapping imagery. This estimate provides an indication of whether the spatial accuracy requirements can be achieved.
- G.5.3.3.2. The visual interpretation of what has to be considered as an obstacle is labour-intensive for photogrammetric data, but, at present, much more reliable than automated image correlation. As the operator has to define which objects are to be considered as obstacles, human interpretation may impact the data homogeneity and data quality. Visual quality checks should be performed for every feature class derived from visual interpretation.
- G.5.3.3.3. The absolute spatial accuracy of photogrammetric data should always be determined by independently surveying features or spot elevations (for terrain data) which are captured in stereo-pairs. The completeness of the feature extraction



should be evaluated by visual field inspection. A random representative sample for the area (i.e. area-guided sampling)<sup>54</sup> should be used in both quality evaluation processes.

## **G.5.4 Surveying using Airborne Laser Scanning**

### **G.5.4.1 Sensor Technique**

- G.5.4.1.1. Within the last few years, ALS or Light Detection and Ranging (LIDAR) has developed significantly with respect to sensor quality and processing algorithms available. ALS is a very efficient technique for 3D data acquisition for corridor (power-lines, pipelines) and mid-sized area mapping because it allows the direct determination of 3D co-ordinates for each illuminated point. For aviation, the focus is on terrain and obstacle data.
- G.5.4.1.2. The sensor system consists of the laser scanner (rotating or oscillating mirror) and a POS. Often a mid-sized digital camera is available or a regular aerial camera is used, together with an ALS, in a combined flight. It is recommended that an imaging sensor is used during ALS data acquisition to facilitate feature extraction.
- G.5.4.1.3. One of the biggest advantages of ALS compared with conventional surveying and Aerial Photogrammetry is the high level of automation offered through a completely digital data chain. Despite the automation, quality control should not be disregarded and surveyors should ensure that the black-boxed processes are well understood.
- G.5.4.1.4. As for Aerial Photogrammetry, the minimum size of the obstacle which needs to be captured is the predominant factor in the planning of an ALS flight. To capture very thin objects, the flight and laser parameters have to be adjusted accordingly. The dominating factor for the selection of the flight level is, therefore, the completeness criteria rather than the spatial accuracy requirement. This also leads to higher acquisition costs for obstacle data compared with most other applications.
- G.5.4.1.5. The more points collected per area, the finer the resolution and the higher the probability that thin objects are detected. One way of increasing the point density is by using a high pulse repetition frequency. It should be taken into account that with increased pulse rate frequency, the signal strength is weakened which may have an impact on the radiometric resolution and the spatial accuracy.

### **G.5.4.2 Operational Procedures**

- G.5.4.2.1. The quality of the acquired ALS data is largely impacted by the preparation for data acquisition and flight planning. As with Aerial Photogrammetry, the flight planning has to consider several factors and it should be conducted carefully to ensure that the resulting quality characteristics meet the requirements (completeness, spatial accuracy). The flight planning should be independently validated. The following parameters should be taken into account:
- Interference with air traffic at the airport which needs to be surveyed;
  - Optimal flight season (leaf-on) and time with respect to predicted quality of GNSS (satellite constellation, see section G.5.2.2)<sup>55</sup>;
  - Required resolution and spatial accuracy requirements;

---

<sup>54</sup> Guidance on lot size and sampling can be found in Annex E of [RD 21].

<sup>55</sup> As an active sensor, ALS can be operated independent of the sunlight.

- Scan angle, scan frequency and pulse repetition frequency;
- Speed of the aircraft;
- Lateral overlap;
- Set up of reference station for differential GNSS.

G.5.4.2.2. To increase the probability that a thin object is captured, the sensor should be tilted.

G.5.4.2.3. Due to the independence of ALS for data acquisition with respect to ground control points, sensor calibration is an important task in order to ensure that the spatial accuracy requirements can be met. A calibration flight should be conducted after each change of the installation and on a regular basis during longer data acquisition projects. The sensor calibration may be augmented by a radiometric calibration to validate that with the chosen flight parameters, the critical (thin) objects are captured. The results from the calibration should be documented.

G.5.4.2.4. During the data acquisition, the operator should ensure that the parameters determined in flight planning are maintained. The operator should also monitor the real-time solution of the POS to detect anomalies as quickly as possible. When more real-time information, like calculation of the swath extent, returned signal statistics and similar, are available, they should be carefully observed.

G.5.4.2.5. Humidity can have a strong impact on the strength of the returned signal (local loss of signal). Strong winds or turbulence increase the possibility that the gathered points are distributed unevenly. Therefore, meteorological restrictions should be carefully observed during data collection.

G.5.4.2.6. After pre-processing the different data streams (POS, laser scanner) and when combining them, a digital point cloud is available which allows for further processing. To detect obstacles, the points are separated into ground and non-ground points<sup>56</sup>. The non-ground points can then be compared with an ODCS and the points describing obstacles can be easily detected. With a tilted sensor, it is expected that, for each object, there are multiple pulses with almost identical x/y but different z co-ordinates registered. Algorithms should be used to determine the reliability of these identified objects. Where only a single echo is registered, plausibility tests and simultaneously acquired imagery should be used to determine if such an object may or may not be an obstacle (for example, the reflection from a bird). Where there are still doubts about whether a point describes an obstacle or not, control survey, with conventional terrestrial survey, should be performed.

G.5.4.2.7. Once points describing an obstacle are selected, they must be grouped and converted to some form of obstacle object, i.e. point, line and polygon. The degree of automation of such a process strongly depends on the quality requirements (i.e. target applications) of the geometry but it is expected that visual interpretation and manual interaction will be needed, in many cases.

### **G.5.4.3 Quality Control**

G.5.4.3.1. The inner spatial accuracy of the geo-referenced point cloud should be estimated with a strip adjustment. The strip adjustment should be made per mission or for the entire area, depending on the size. This estimate provides an indication of whether the spatial accuracy requirements can be achieved.

---

<sup>56</sup> Mature algorithms are available to extract a DTM from the point cloud. Since accuracy requirements are relatively low compared with the high number of points registered, processing is automated to a high degree.

- G.5.4.3.2. The absolute spatial accuracy of data derived from ALS should always be determined by independently surveying features or spot elevations (for terrain data).
- G.5.4.3.3. Manual interaction in deriving obstacle data impacts the data homogeneity and data quality. Visual quality checks should be performed for every feature derived by visual interpretation.
- G.5.4.3.4. The completeness of the feature extraction should be evaluated by visual field inspection. Again, a random sample which is representative of the area (i.e. area-guided sampling) should be used.

## Annex H SPECIFICATION UPDATE PROCEDURES

It is necessary to periodically check this EUROCONTROL Specification for consistency with referenced material, notably ICAO international and regional SARPs and manuals<sup>57</sup>. It is also expected to evolve following real project and field experience, as well as advances in technology.

The main objectives of the continuous review are:

- to improve the quality of the requirements (e.g. clarity, testability, etc.);
- to verify that the level of detail published is adequate;
- to ensure that design-oriented requirements, imposing unnecessary constraints to technical solutions, have been avoided;
- to ensure that advances in technology are properly reflected;
- to make the supplying industry aware of the developments and directions in Aeronautical Information systems and prepared to cover and supply the appropriate systems.

Updates will follow EUROCONTROL Notice of Proposed Rule Making (ENPRM) procedures<sup>58</sup> using the process outlined in this section.

The update process for this EUROCONTROL Specification may be summarised as follows:

- 1) All change proposals and issued changes to referenced documents will be checked in detail by an Impact Assessment Group. An Impact Assessment Report will be generated for consideration by the Specification Drafting Group (SDG).
- 2) The SDG will compose a new Internal Draft to propose changes, covering the impact assessment, for internal discussion.
- 3) The new Internal Draft will be assessed for conformance against the regulations, any relevant ICAO policies and safety considerations.
- 4) If necessary further Internal Drafts will be produced.
- 5) After the SDG has finalised the updates a new Intermediate Draft will be issued for review by Stakeholders in accordance with ENPRM mechanisms. Workshops may need to be conducted depending on the extent of the changes.
- 6) Following the reception of comments, further Intermediate Drafts will be produced, as necessary, and distributed for confirmation of correct update (optional).
- 7) Following a suitable period for further response, assuming that no objections have been raised, the resulting draft will be upgraded to the new Baseline Version. Approval and document change record sections will be updated accordingly. A date will be negotiated with Stakeholders and set for applicability of the revised facilities. The new baseline document will be considered to be in force from that date onwards.
- 8) Where appropriate, a recommendation will be made to the European Commission to update the reference in the Official Journal of the European Union to recognise this new version as a European Community Specification acceptable as a MoC with the European Community Regulations.

- End of Document -

---

<sup>57</sup> The mechanisms and working arrangements necessary to perform these checks are in the process of being considered.

<sup>58</sup> ENPRM procedures are defined in [www.eurocontrol.int/enprm](http://www.eurocontrol.int/enprm).



© February 2013 – European Organisation for the Safety of Air Navigation (EUROCONTROL)

This document is published by EUROCONTROL for information purposes. It may be copied in whole or in part, provided that EUROCONTROL is mentioned as the source and it is not used for commercial purposes (i.e. for financial gain). The information in this document may not be modified without prior written permission from EUROCONTROL.

[www.eurocontrol.int](http://www.eurocontrol.int)