

ICAO PBN Workshop

Tanzania

RNP APCH



RNP APCH overview

- RNP APCH introduction
- Airborne RNP APCH system performance
 - LNAV
 - LNAV/VNAV
 - LPV
- RNP APCH Operational approval process

RNP APCH overview

- RNP APCH introduction
- Airborne RNP APCH system performance
 - LNAV
 - LNAV/VNAV
 - LPV
- RNP APCH Operational approval process

RNP APCH introduction

RNP APCH is the PBN navigation specification dealing with approach procedure using GNSS.

Those approaches are generally charted under the name RNAV(GNSS) or RNAV(GPS)

A RNP APCH approach covers three possible types of approach procedure:

| | | |
|------------------------|--|-------------------|
| Non-precision approach | Identified on the IAC chart by the minima line | LNAV - MDA/MDH |
| APV BaroVNAV approach | Identified on the IAC chart by the minima line | LNAV/MNAV - DA/DH |
| APV SBAS approach | Identified on the IAC chart by the minima line | LPV - DA/DH |

APV stands for Approach with vertical Guidance

RNP APCH introduction

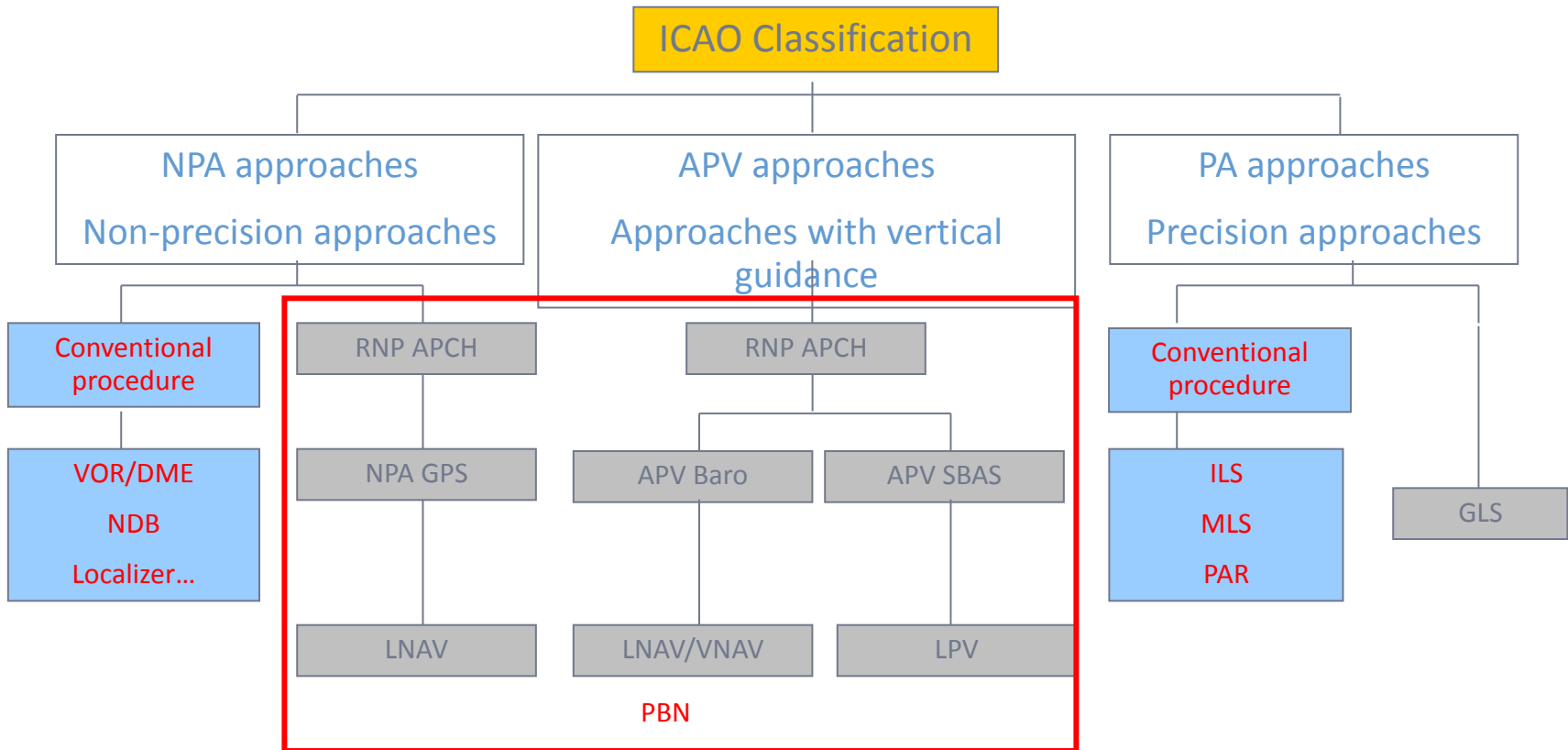

APV approaches offer vertical guidance but with a lower performance than the one required for a precision approach

RNP APCH introduction

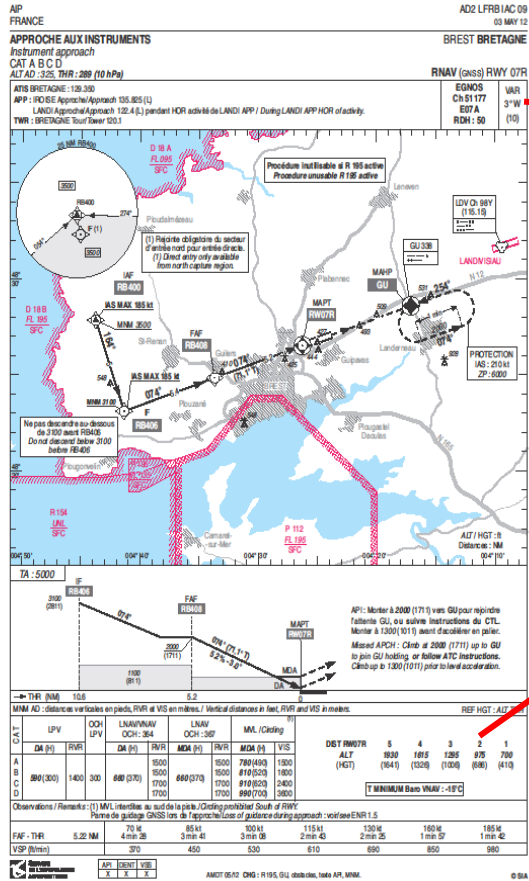

AIP
FRANCE

APPROCHE AUX INSTRUMENTS
Instrument approach
CAT A B C D
ALT AD : 325, THR : 289 (10 hPa)

ATIS BRETAGNE : 129.350
APP : IROISE Approchel/Approach 135.825 (L)
LANDI Approchel/Approach 122.4 (L) pendant HOR activité de LANDI APP / During LANDI APP HOR of activity.
TWR : BRETAGNE Tour/Tower 120.1

AD2 LFRB IAC 09
03 MAY 12

BREST BRETAGNE

RNAV (GNSS) RWY 07R

EGNOS
Ch 51177
E07A
RDH : 50

VAR
3° W
(10)

→ THR (NM) 10.6 5.2 0

MNM AD : distances verticales en pieds, RVR et VIS en mètres. / Vertical distances in feet, RVR and VIS in meters. REF HGT : ALT THR

| CAT | LPV | | OCH LPV | LNAV/VNAV OCH : 364 | | LNAV OCH : 367 | | MVL / Circling ⁽¹⁾ | | DIST RW07R | | | | | |
|-----|-----------|------|---------|---------------------|------|----------------|------|-------------------------------|------|------------|--------|--------|--------|-------|-------|
| | DA (H) | RVR | | DA (H) | RVR | MDA (H) | RVR | MDA (H) | VIS | 5 | 4 | 3 | 2 | 1 | |
| A | | | | | 1500 | 1500 | 1500 | 780 (490) | 1500 | 1930 | 1615 | 1295 | 975 | 700 | |
| B | 590 (300) | 1400 | 300 | 660 (370) | 1500 | 1700 | 1700 | 810 (520) | 1600 | (HGT) | (1641) | (1326) | (1006) | (686) | (410) |
| C | | | | | 1700 | 1700 | 1700 | 990 (700) | 2400 | | | | | | |
| D | | | | | 1700 | 1700 | 1700 | 3600 | | | | | | | |

T MINIMUM Baro VNAV : -15°C

Observations / Remarks : (1) MVL interdites au sud de la piste. / Circling prohibited South of RWY.
Panne de guidage GNSS lors de l'approche / Loss of guidance during approach : voir/see ENR 1.5

| FAF - THR | VSP (ft/min) | 70 kt | 85 kt | 100 kt | 115 kt | 130 kt | 160 kt | 185 kt |
|-----------|--------------|----------|----------|----------|----------|----------|----------|----------|
| 5.22 NM | 370 | 4 min 28 | 3 min 41 | 3 min 08 | 2 min 43 | 2 min 25 | 1 min 57 | 1 min 42 |

SERVICE DE L'INFORMATION AERONAUTIQUE

| API | IDENT | VSS |
|-----|-------|-----|
| X | X | X |

AMDT 05/12 CHG : R 195, GU, obstacles, texte API, MNM.

© SIA



RNP APCH introduction

Airborne architecture Outlines

- Airborne architecture is similar to the one supporting Enroute and Terminal operations:
 - Main difference between General aviation aircraft and air transport
 - Single sensor versus multisensor
 - Single system versus dual system
 - Complexity of the installation
 - Coupling with the autopilot and/or flight director
 - Level of RNAV functionalities

RNP APCH introduction

Airborne architecture Outlines

- Lateral guidance is computed by the airborne system.
 - The lateral guidance is displayed on a lateral deviation indication (a CDI, a HSI or an EFIS). A moving map display could be also used.



Digital cross track

- Vertical guidance is computed by certain RNAV systems: the vertical guidance is based on GNSS (SBAS or GBAS concept) or on pressure-altitude (Baro VNAV concept)
 - The vertical guidance is displayed on a vertical deviation indication (a VDI, a HSI or an EFIS).

RNP APCH introduction

Materials for RNP APCH LNAV and LNAV/VNAV

ICAO Doc 9613 PBN Manuel VOL II Part C Chapter 5: RNP APCH

Airworthiness Reference

- ✓ EASA AMC 20-27
- ✓ FAA AC 20-130A, AC 20-138A, AC 20-129, (replaced by AC 20-138B and C)
- ✓ ETSO/TSO C129a, ETSO/TSO C145 and C146

Operational Reference

- ✓ EASA AMC 20-27: « airworthiness approval and operational criteria for RNP approach (RNP APCH) operations”
- ✓ DGAC OPS directive F 2012-02
- ✓ DGAC Technical guidelines for RNP APCH operations known as RNAV(GNSS)
- ✓ FAA AC 90-105

RNP APCH introduction

Materials for RNP APCH LPV

ICAO Doc 9613 PBN Manuel VOL II Part C Chapter 5: RNP APCH

Airworthiness Reference

- EASA AMC 20-28 airworthiness approval for LPV operations
- FAA AC Airworthiness : 20-130A, AC 20-138A (replaced by AC 20-138C)
- ETSO/TSO C145 and C146

Operational Reference

- EASA AMC 20-28 airworthiness approval and operational criteria for LPV operations
- DGAC : OPS directive F 2012-02
- DGAC Guidelines for RNP APCH operations also known as RNAV(GNSS)
- FAA AC OPS :AC 90-107,.....

RNP APCH overview

- RNP APCH introduction
- Airborne RNP APCH system performance
 - LNAV
 - LNAV/VNAV
 - LPV
- RNP APCH Operational approval process

RNP APCH – LNAV – aircraft requirements

non-precision approach - RNAV(GNSS) LNAV

RNAV(GNSS) LNAV approaches are not associated with a vertical track in space.

- Lateral guidance is by means of the RNAV/GNSS system and is based on GNSS positioning
- Vertical flight management the same as for non-precision approaches (VOR/DME, NDB, etc.),
- In accordance with EU OPS, non-precision approaches meeting CDFA criteria must be carried out using the CDFA technique.

For a non-precision RNAV(GNSS) / LNAV minima approach:

The operator must comply with EASA AMC 20-27 (chapter 10 and appendix 4)

RNP APCH

Charted RNAV(GNSS) or RNAV(GPS)

APPROCHE AUX INSTRUMENTS

Instrument approach

CAT A B C D

ALT AD : 325, THR : 289 (10 hPa)

LFRB LNAV LNAV-VNAV LPV 07R IAC V12
du 18-10-2010

BREST BRETAGNE

RNAV(GNSS) RWY 07R

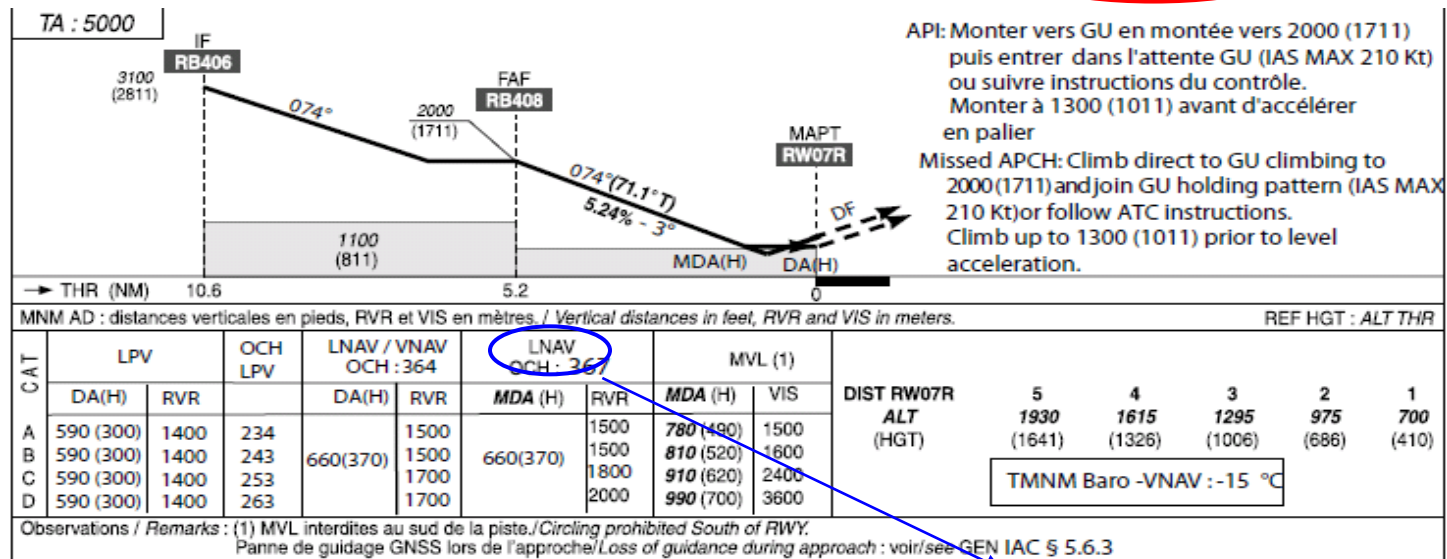

Non-precision approach (AMC 20-27)

Lateral guidance: GNSS

Vertical plane management: CDFA (use of V/S, FPA or (Baro) VNAV for aircraft so equipped)

RNP APCH LNAV – aircraft requirements

- An airborne system approved for RNP APCH / LNAV
 - Airworthiness and operational criteria are defined in a European document AMC 20-27 and are consistent with the ICAO PBN manual
 - An RNAV system based on GNSS positioning.
- Lateral navigation
 - Flight plan construction builds from an embedded navigation data base
 - Provides display of all necessary flight navigation parameters in order to conduct a safe approach
- Vertical navigation
 - No requirement.
 - Vertical flight management the same as for non-precision approaches (VOR/DME, NDB, etc.),
 - In accordance with OPS European regulation, non-precision approaches meeting CDFA criteria must be carried out using the CDFA technique.

RNP APCH LNAV – aircraft requirements

The airborne RNAV/GNSS system should be:

- a stand-alone GPS system compliant with TSO C129a/ETSO C129a class A1 or TSO C 146A (SBAS receiver)
- a multisensor system with GNSS sensor compliant with TSO C 129()/ETSO C129() class B1/B3,C1 or C3 or TSO C 145A.

For multi sensor system, the active positioning sensor must be indicated to the crew.

The active sensor must be the GPS when conducting the approach.

Approach procedure are designed in accordance with PANS OPS Doc 8168, Volume II,

Part III, Section 3, Chapter 3.

Airborne certification criteria have been developed for “straight segment” approach

(e.g. T or Y approach) to accommodate basic stand-alone GNSS receiver.

RNP APCH LNAV – aircraft requirements

Accuracy

- The lateral TSE must be within ± 1 NM (95%) for the initial, intermediate and missed approach segment
- The lateral TSE must be within ± 0.3 NM (95%) for the Final segment
- The Total System Error is the Root Sum Square (RSS) of:
 - Navigation system error (NSE)
 - Path definition error (PDE)
 - Flight technical error (FTE)

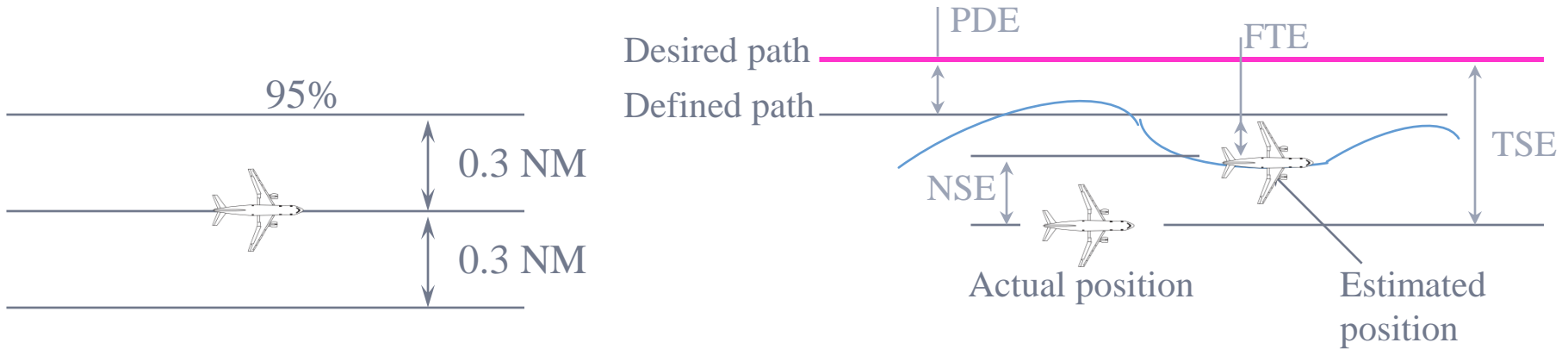

RNP APCH LNAV – aircraft requirements

Integrity and continuity

- Total loss of navigation must be remote at aircraft level (occurrence less than 10^{-5} /per flight hour)
- Erroneous displayed information must be remote at system level (occurrence less than 10^{-5} / per approach)
- An On Board Performance monitoring and Alerting Function is required

RNP APCH LNAV – aircraft re

Functional criteria

- Continuous indication of aircraft position relative to track on a navigation display situated in pilot primary field of view
- Or
- Position indication on an approved moving map display



1. Vertical deviation scale.
2. Lateral deviation scale.
3. CDI Lateral deviation scale.

Lateral deviation display with +/- 0.3 Nm Full Scale on the Final segment



Cross track error

Functional criteria

- Capability for the « Direct To » function (1)
- Display of distance and bearing to the active waypoint (2)
- Display of ground speed or time to the active waypoint (3)
- Display of the identification of the active (TO) waypoint (4)
- Display of the active navigation sensor type for multi-sensor systems



RNP APCH LNAV – aircraft requirements

Functional criteria

- Navigation Data Base
 - Storage of the complete approach procedure including the missed approach
 - Selection of the approach by its name (e.g “RNAV(GNSS) RWY 13L”)
- Capability to execute leg transitions and maintain tracks consistent with the following path terminators
 - Initial Fix (I.F); Track between two Fixes (T.F) and Direct to a Fix (D.F)
- Automatic leg sequencing and associated turn anticipation.
 - Capability to execute transition database procedures (Fly-over and Fly-by turns)

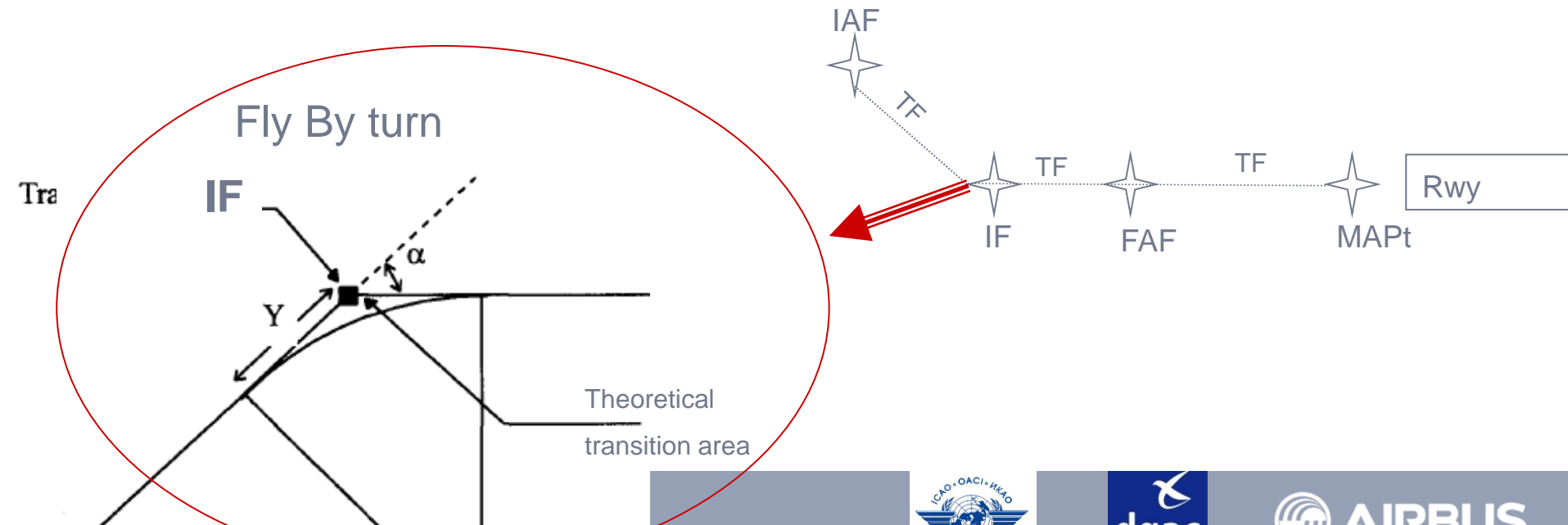

RNP APCH LNAV – aircraft requirements

Functional criteria

Enhanced navigation displays improve lateral situational awareness, navigation monitoring and approach verification (flight plan validation).



Autopilot and/or Flight Director coupling is required if TSE (accuracy) in “manual flight” cannot be maintained.



Display indicator with course selector automatically slaved to the RNAV computed path is highly recommended to alleviate crew workload.

LNAV & CDFA

European Ops requirement (OPS 1.430)

All non-precision approaches shall be flown using the continuous descent final approaches (CDFA) technique

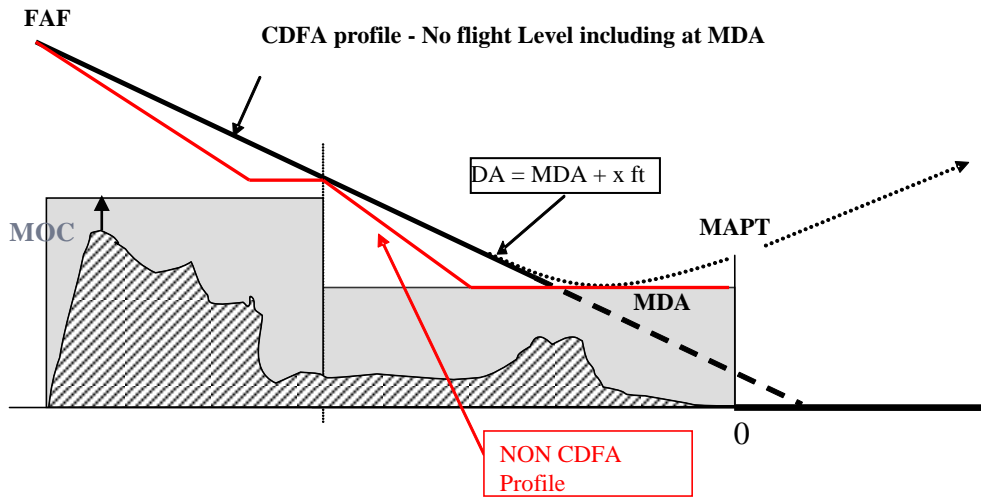

LNAV & CDFA

Continuous descent path

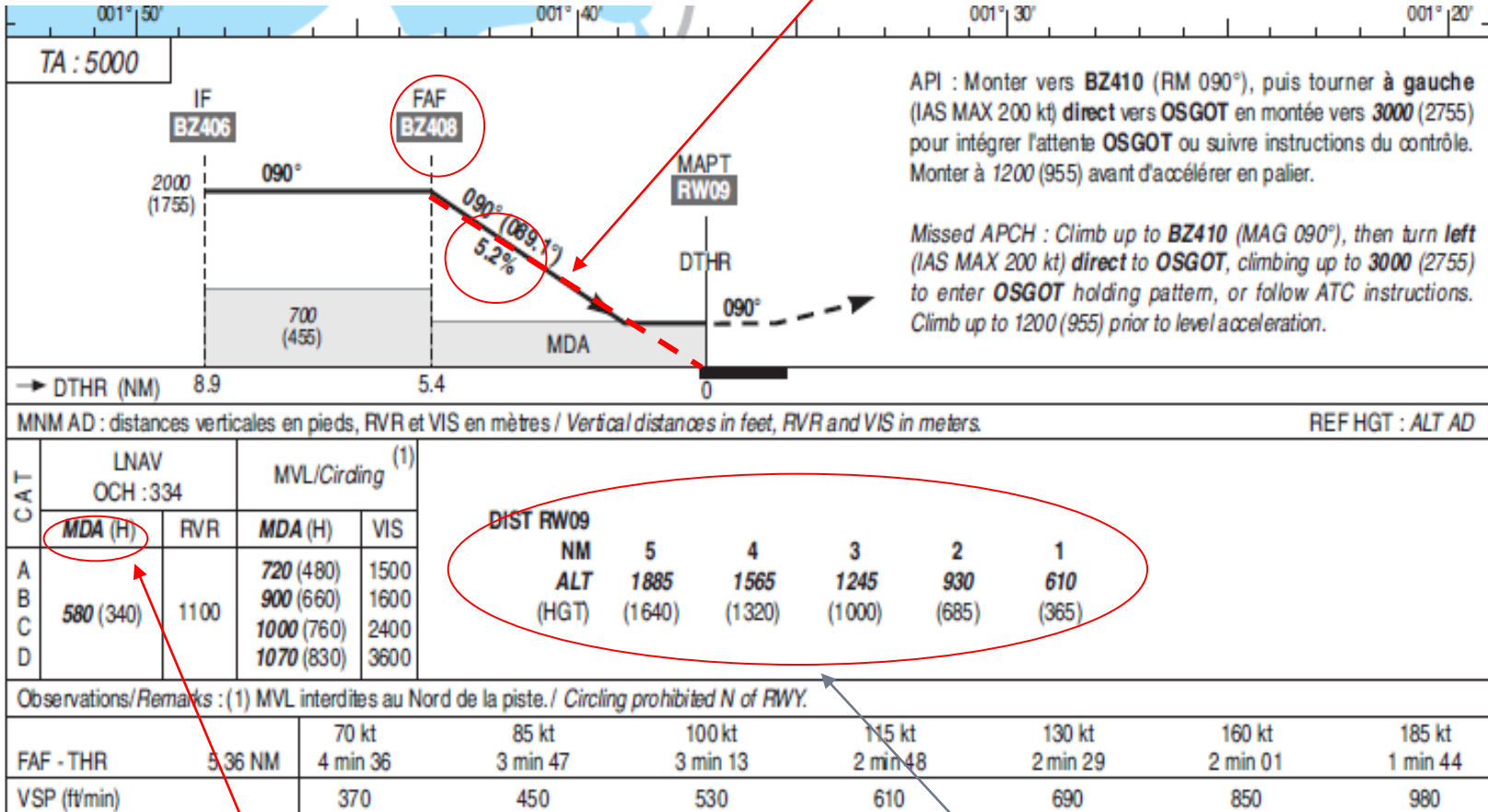

Minimum Descent Altitude

Distance - altitude Table

LNAV & CDFA

- CDFA is a flight technique and does not recommend any particular on-board means.
 - It can be carried out using vertical speed (V/S) or flight path angle (FPA) indications, or the (Baro) VNAV function if available.
- the vertical path trajectory is checked using the distance - altitude table and/or the table giving the flight time and vertical speed between the FAF and the MAPt.

LNAV & CDFA

The notion of MDA disappears because CDFA no longer allows a level flight segment to the MAPt.

The CDFA technique requires a go-around if the visual references are not acquired at a DA(H) (decision altitude/height).

MDA is determined from an OCA which does not take into account the height loss at go around

MDA (Minimum Descent Altitude) cannot be used as a DA (Decision Altitude) without a specific assessment:

- To use the add-on concept: $DA = MDA + xx\text{Ft}$ (e.g. xx is based on aircraft performance or could be a fixed value of 50 Ft)
- To assess from an obstacle point of view the area below the MDA zone (e.g VSS, MAPt location).

| Catégorie d'aéronefs | Marge |
|----------------------|-------|
| A | 20 ft |
| B | 30 ft |
| C | 40 ft |
| D | 60 ft |

Tableau des marges à ajouter selon la catégorie de l'aéronef

RNP APCH overview

- RNP APCH introduction
- Airborne RNP APCH system performance
 - LNAV
 - LNAV/VNAV
 - LPV
- RNP APCH Operational approval process

RNP APCH LNAV/VNAV – aircraft requirements

APV BaroVNAV – RNAV(GNSS) LNAV/VNAV

- Lateral guidance is by means of the RNAV/GNSS system and is based on GNSS positioning
- Vertical guidance uses the (baro) VNAV function,
- Certification criteria are included in EASA AMC 20-27.

RNP APCH LNAV/VNAV

APPROCHE AUX INSTRUMENTS

Instrument approach

CAT A B C D

ALT AD : 325, THR : 289 (10 hPa)

LFRB LNAV LNAV-VNAV LPV 07R IAC V12
du 18-10-2010

BREST BRETAGNE

RNAV(GNSS)RWY 07R

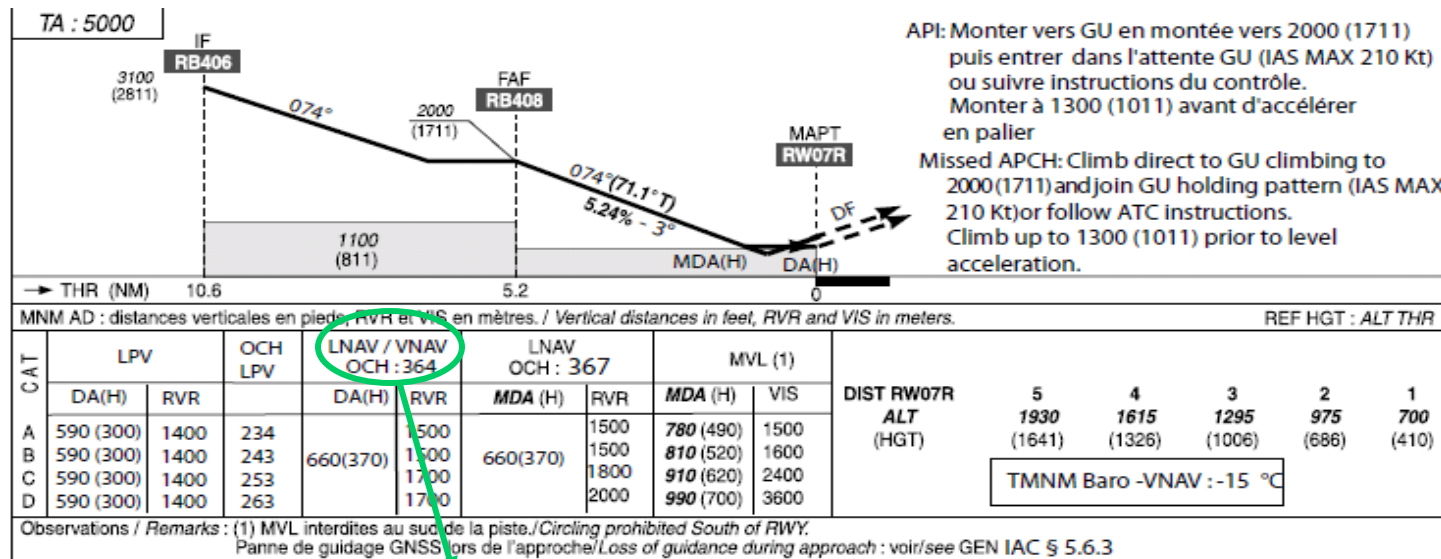

APV BaroVNAV (AMC 20-27)

Lateral guidance: GNSS

Vertical guidance:

(Baro)VNAV

RNP APCH - LNAV/VNAV

- Baro-VNAV systems are already fitted onboard Air Transport aircraft and business jet.
- Use of Baro-altitude data (aircraft anemometric data) as the primary information to elaborate the vertical guidance.
 - Static probes
 - Air Data Computer
- The integrated navigation system (eg FMS) computes a vertical guidance based on baro altitude data and the vertical path to be flown stored in the navigation data base.

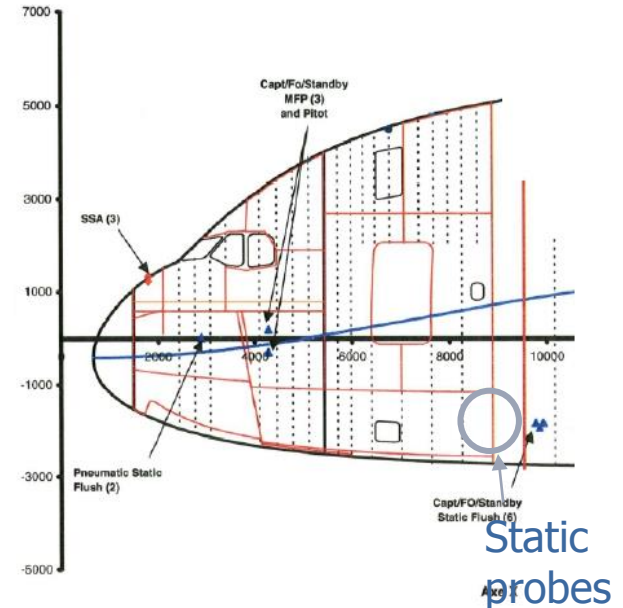
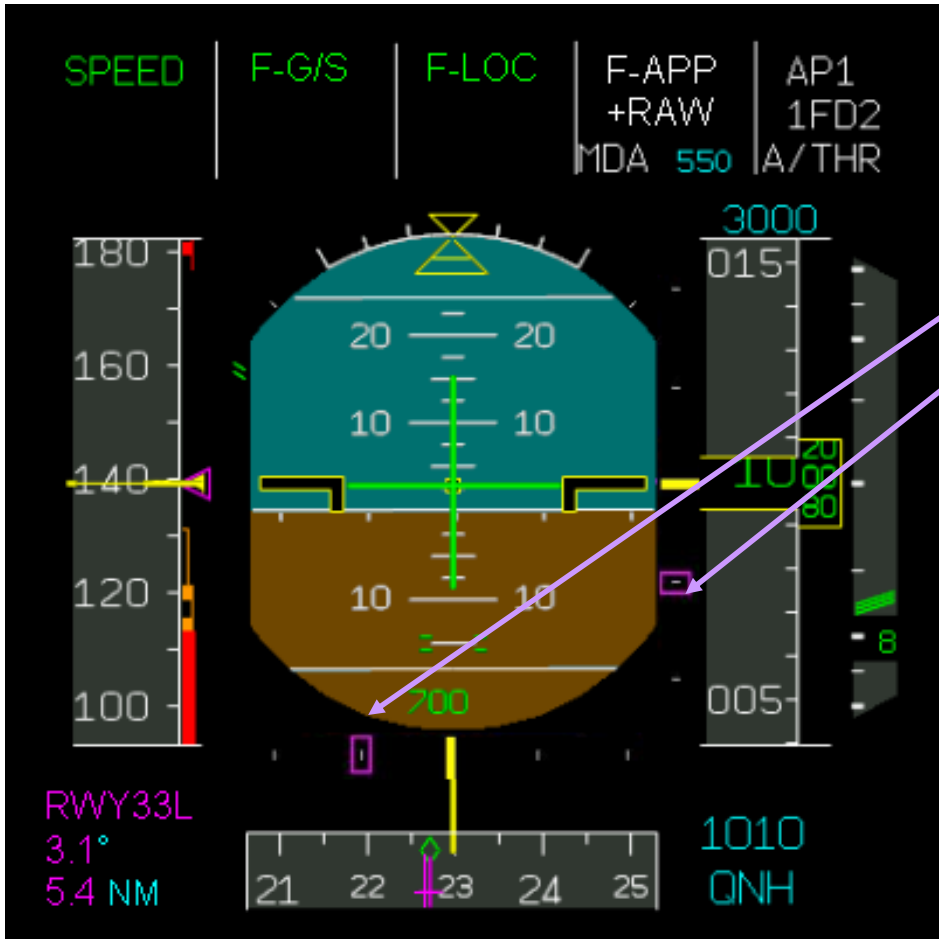

Figure 3 - ADIRS - Probes Location

RNP APCH - LNAV/VNAV



□ Symbology

- 1) Lateral deviation
- 2) Vertical deviation

- Generally lateral and vertical guidance are linear (e.g. full scale +/- 200 ft)
- But there is now design with ILS look alike (angular) presentation

Innovation and commonality - FLS Non Precision Approaches : Principles

- **Virtual FLS beam built by the FMS according to database information corresponding to the NPA selected by the crew**
 - defined by an anchor point, a slope, a course

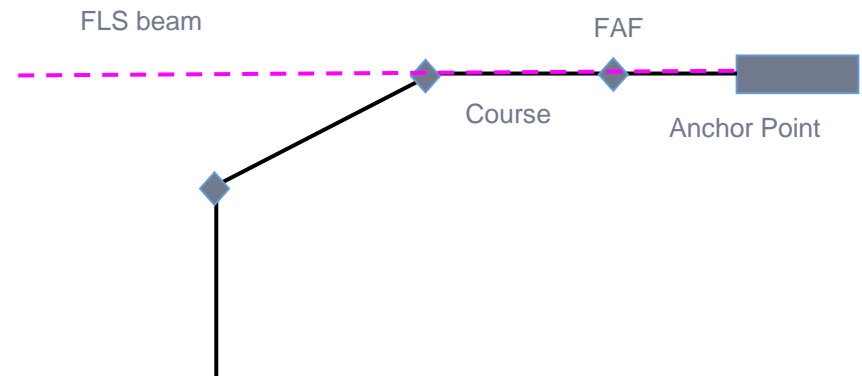
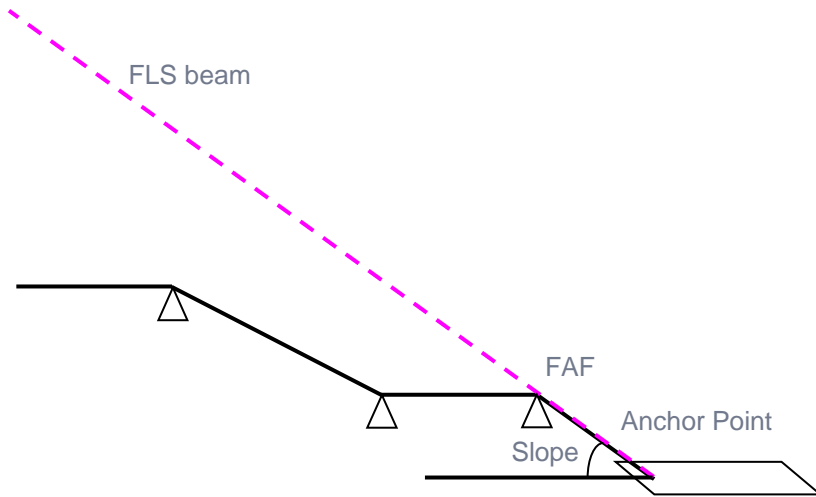

- MMR computes lateral and vertical deviations between FLS beam and FMS A/C position
- A/C is guided on the FLS beam re-using FG ILS guidance laws
- FLS parameters and FLS beam are displayed on ND/PFD for pilot cross check

Innovation and commonality - FLS Non Precision Approaches : PFD

Guidance modes

Approach capability

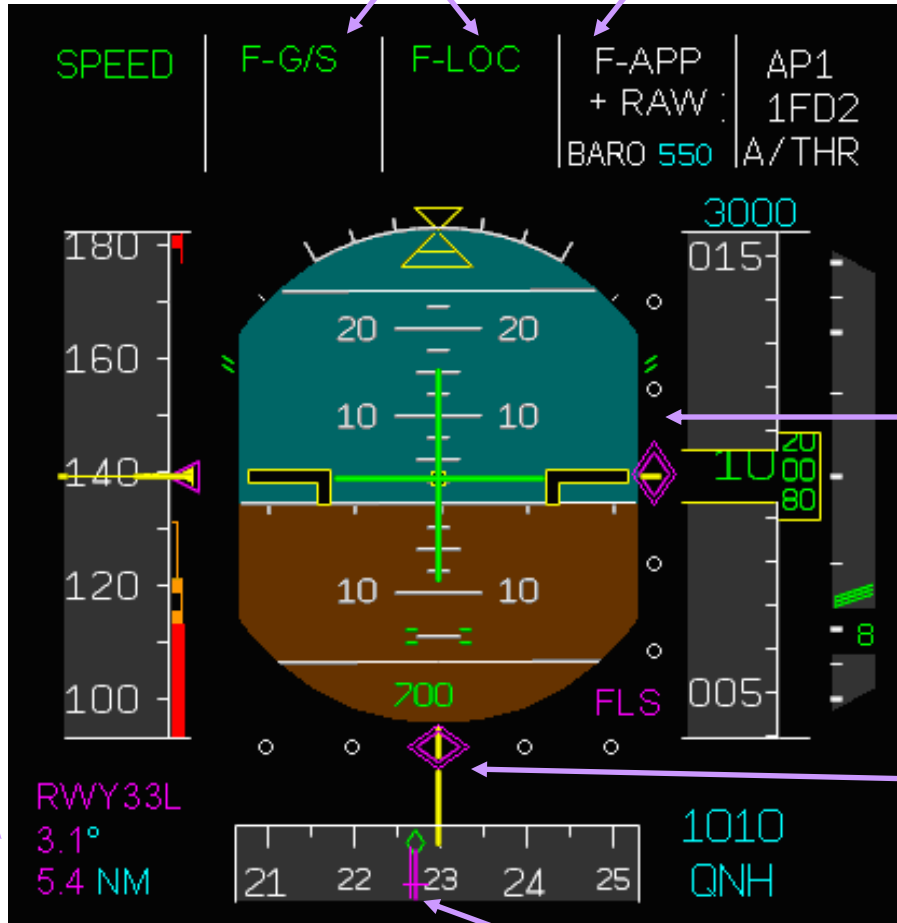

FLS info
(Anchor point id,
slope,
distance to rwy
threshold)

2 Pseudo G/S scale
& index

1 Pseudo LOC scale &
index

3 Course pointer

4



RNP APCH - LNAV/VNAV – aircraft requirements

- Approach designed i.a.w APV Baro VNAV PANS OPS criteria.
- APV Baro-VNAV approach procedures are classified as instrument procedures in support of approach and landing operations with vertical guidance (APV).
- Approach plate clearly indicates this type of operation:
 - « LNAV/VNAV » minima specified in the minimum box
 - Use of a DA(H) and not a MDA
 - VPA indicated in °
 - RDH (Wpt coordinates, height)
 - Temperature limitation

RNP APCH - LNAV/VNAV – aircraft requirements

- Navigation data base should contain WPTs and RNAV/VNAV information (RDH and VPA).
 - The approach (lateral and vertical elements) loaded into the RNAV system must be validated by the operator
- Longitudinal accuracy of the RNAV system must be at least 0.3 NM (95%) to bound the horizontal coupling error (impact of longitudinal error on the vertical plane).

RNP APCH LNAV/VNAV – aircraft requirements

APPROCHE AUX INSTRUMENTS

Instrument approach

CAT A B C D

ALT AD : 325, THR : 289 (10 hPa)

LFRB LNAV LNAV-VNAV LPV 07R IAC V12
du 18-10-2010

BREST BRETAGNE

RNAV(GNSS)RWY 07R

TA : 5000

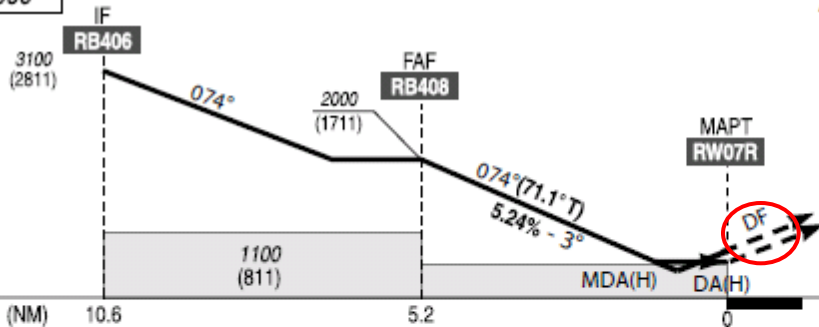

API: Monter vers GU en montée vers 2000 (1711) puis entrer dans l'attente GU (IAS MAX 210 Kt) ou suivre instructions du contrôle. Monter à 1300 (1011) avant d'accélérer en palier

Missed APCH: Climb direct to GU climbing to 2000(1711) and join GU holding pattern (IAS MAX 210 Kt) or follow ATC instructions. Climb up to 1300 (1011) prior to level acceleration.

MNM AD : distances verticales en pieds, RVR et VIS en mètres. / Vertical distances in feet, RVR and VIS in meters. REF HGT : ALT THR

| CAT | LPV | | OCH LPV | LNAV / VNAV OCH : 364 | | LNAV OCH : 367 | | MVL (1) | | DIST RW07R ALT (HGT) | 5 1930 (1641) | 4 1615 (1326) | 3 1295 (1006) | 2 975 (686) | 1 700 (410) |
|-----|-----------|------|---------|--------------------------|---------|-------------------|-----------|-----------|------|----------------------------|---------------------|---------------------|---------------------|-------------------|-------------------|
| | DA(H) | RVR | DA(H) | RVR | MDA (H) | RVR | MDA (H) | VIS | | | | | | | |
| A | 590 (300) | 1400 | 234 | | 1500 | 1500 | 780 (490) | 1500 | | | | | | | |
| B | 590 (300) | 1400 | 243 | 660(370) | 1500 | 660(370) | 1500 | 810 (520) | 1600 | | | | | | |
| C | 590 (300) | 1400 | 253 | | 1700 | 1800 | 910 (620) | 2400 | | | | | | | |
| D | 590 (300) | 1400 | 263 | | 1700 | 2000 | 990 (700) | 3600 | | | | | | | |

TMNM Baro -VNAV : -15 °C

Observations / Remarks : (1) MVL interdites au sud de la piste. / Circling prohibited South of RWY.
Panne de guidage GNSS lors de l'approche / Loss of guidance during approach : voir / see GEN IAC § 5.6.3



RNP APCH - LNAV/VNAV – aircraft requirements

- APV BAROVNAV deviation must be displayed on a vertical deviation display (HSI, EHSI, VDI).
- This display must be used as primary flight instruments for the approach.
- The display must be visible to the pilot and located in the primary field of view
- => suitable fullscale deflection.

- The non-numeric display must allow the flight crew to readily distinguish if the vertical deviation exceeds ± 75 feet.

- If not => it may imply the use of FD or A/P provided an adequate numeric display to allow the pilot to readily distinguish if the vertical deviation exceeds ± 75 feet

RNP APCH LNAV/VNAV – aircraft requirements

Obstacles assessed through OAS
Obstacle Assessment Surface

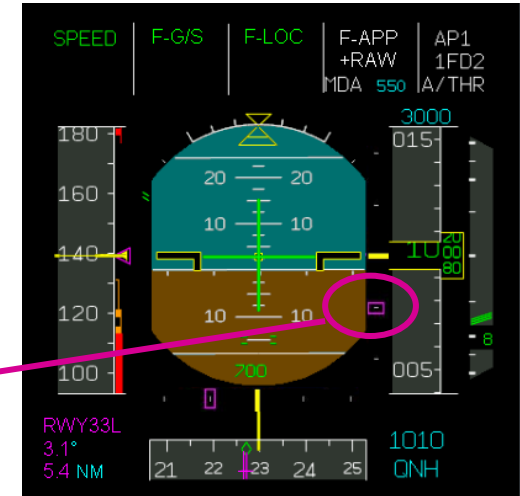
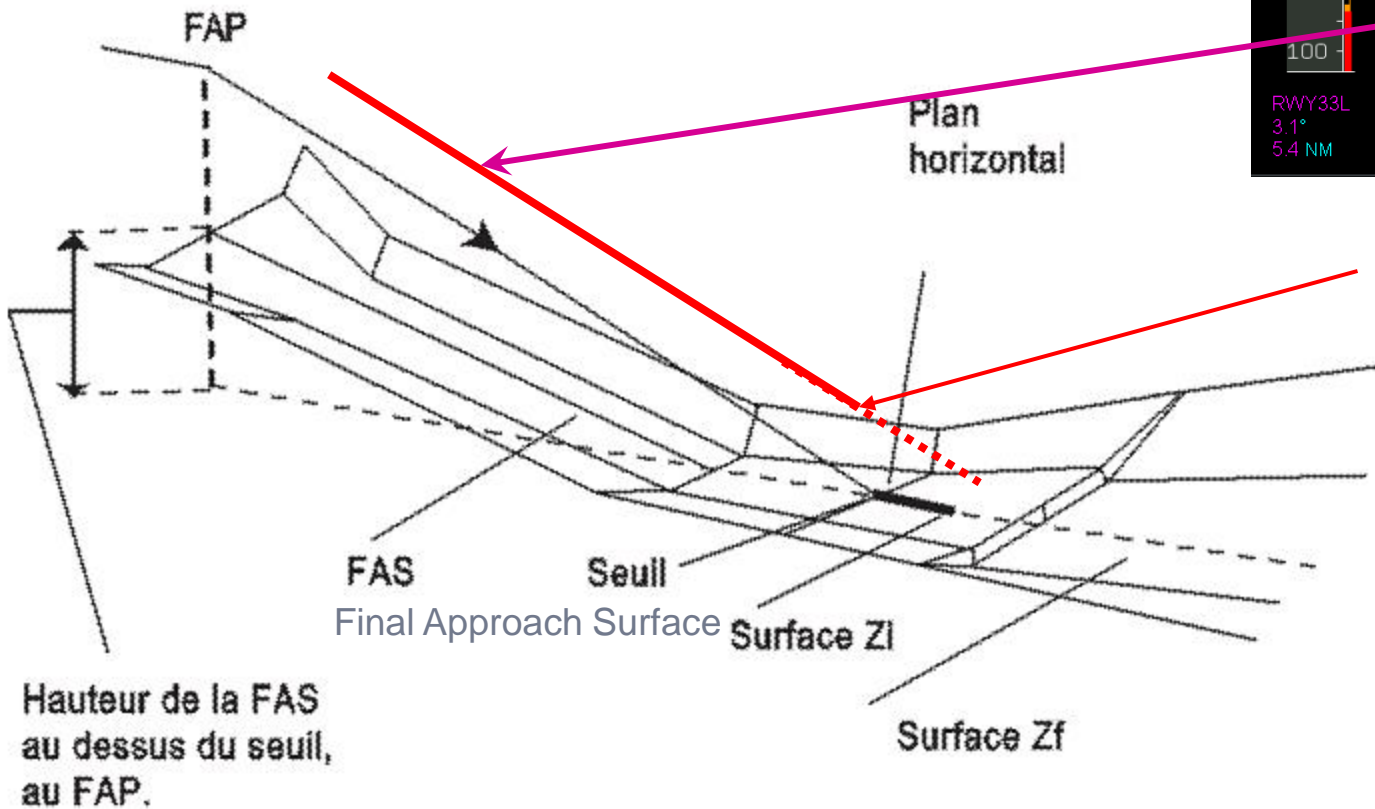

DA/H Decision
Altitude/ Height

RNP APCH LNAV/VNAV – aircraft requirements

- The Baro-VNAV is the vertical primary guidance during an APV Baro VNAV approach
 - Accuracy and integrity performance must be commensurate with this operation
- The aircraft altimetry system should be compliant either to:
 - FAA TSO-C106, Air Data Computer or
 - Air data system, ARINC 706, Mark 5 Air Data System or
 - Barometric altimeter system compliant with DO-88 (Altimetry) and/or ED-26 ‘MPS for Airborne Altitude Measurements and Coding Systems) or
 - Type certified integrated systems providing an Air Data System capability comparable to Arinc 706 Air Data System

RNP APCH LNAV/VNAV – aircraft requirements

- ASE (Altimetry system Error): Altimetry system performance is demonstrated separately through the static pressure systems certification (e.g. FAR or CS 25.1325 compliance)
 - ASE performance must be better than 30 feet per 100 KIAS.
 - Altimetry systems meeting such a requirement will satisfy the ASE requirements for APV Baro-VNAV operation.
- VNAV accuracy : the error of the airborne VNAV equipment, excluding altimetry, should be less than 150 ft (99,7%) when the aircraft is below 5000 ft and is descending.
- FTE should be less than 200 ft (99,7%) when the aircraft is below 5000 ft and is descending.
- In all cases vertical TSE, excluding ASE, must be less than 224 ft (99,7%) when the aircraft is below 5000 ft and is descending.
- An acceptable means of complying with these accuracy requirements is to have an RNAV system approved for VNAV approaches in accordance with the criteria of FAA AC20-129 and an altimetry system approved in accordance with FAR/CS 25.1325 or equivalent.
- AMC 20-27 has more stringent requirements than AC 20-129 regarding TSE
- AC 20-138C has even more stringent requirements than AMC 20-27 regarding TSE

RNP APCH overview

- RNP APCH introduction
- Airborne RNP APCH system performance
 - LNAV
 - LNAV/VNAV
 - LPV
- RNP APCH Operational approval process

RNP APCH - LPV – aircraft requirements

APV SBAS – RNAV(GNSS) LPV

- Lateral and vertical guidance use the RNAV/GNSS system and are based on GNSS positioning using the GPS signal and the SBAS (WAAS in the United States and EGNOS in Europe).
- The system certification criteria : EASA AMC 20-28.

RNP APCH LPV – aircraft requirements

- Display information : ILS look alike
 - Angular deviations lateral and vertical
- Accuracy
 - Latéral: 1.5 m (95%)
 - Vertical: 2 m (95%)
- Alert Limit for the current LPV
 - HAL = 40 m
 - VAL= 50 m
- Publication of a FAS datablock (for the database encoder) => Final Segment

RNP APCH LPV – aircraft requirements

- SBAS is designed to improve the accuracy, integrity and availability of the Global Positioning System (GPS) required by civilian air navigation for approaches
- SBASs are regional systems: WAAS in US, EGNOS in Europe.
- The approach operation associated to SBAS is named LPV (Localizer Precision with Vertical guidance).
 - Provides lateral and vertical guidance
 - Thousands LPV approaches have been published in the US

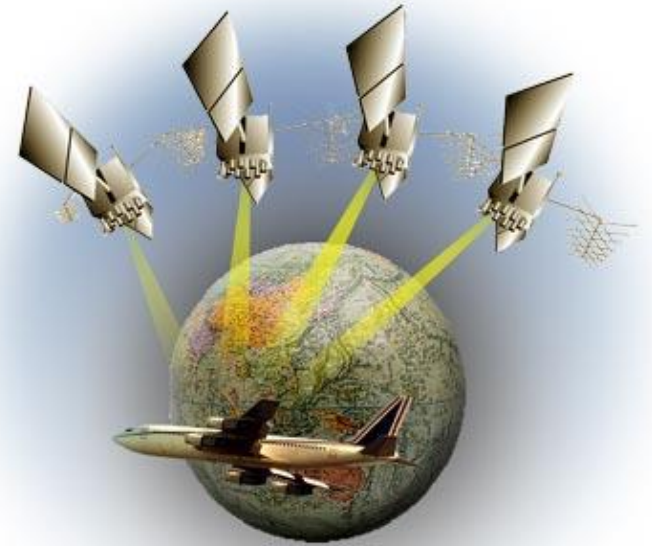

SBAS coverage

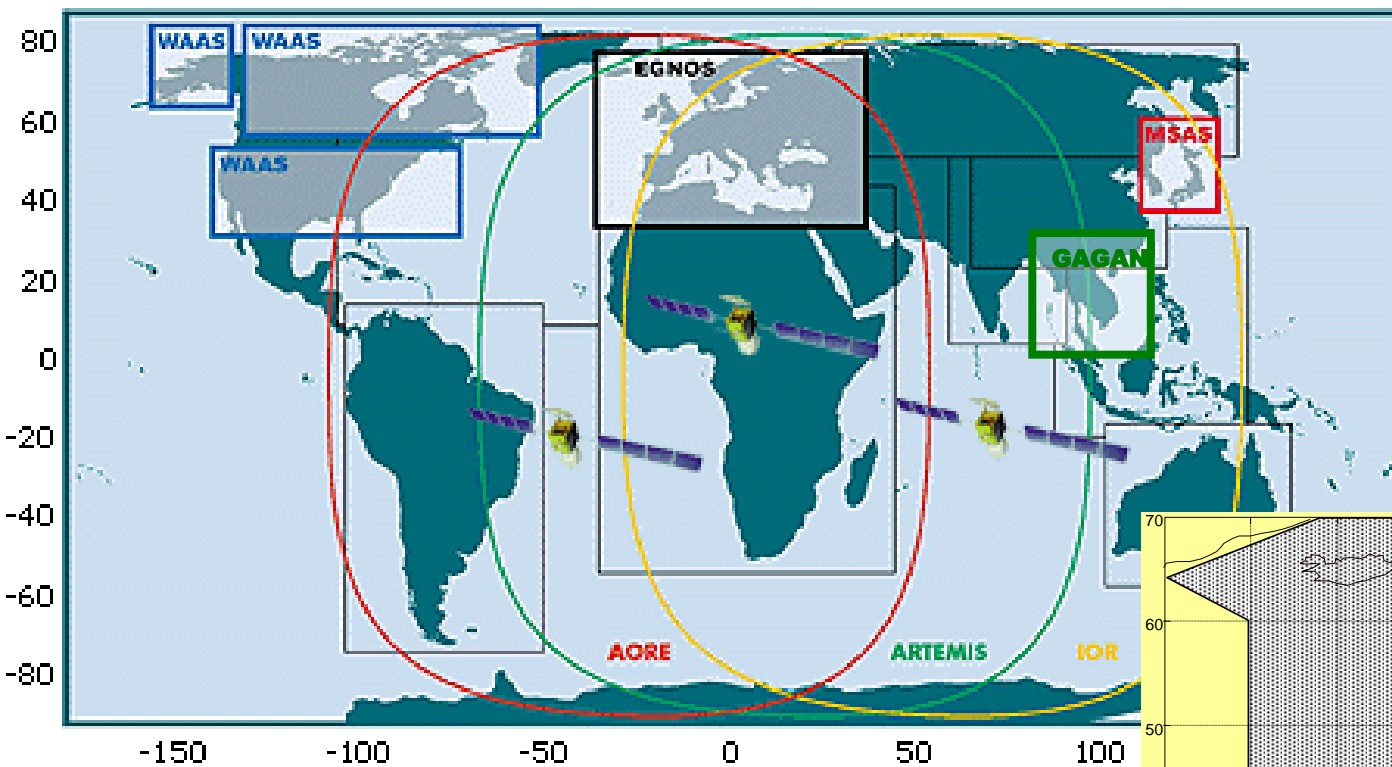

EGNOS in ECAC
area

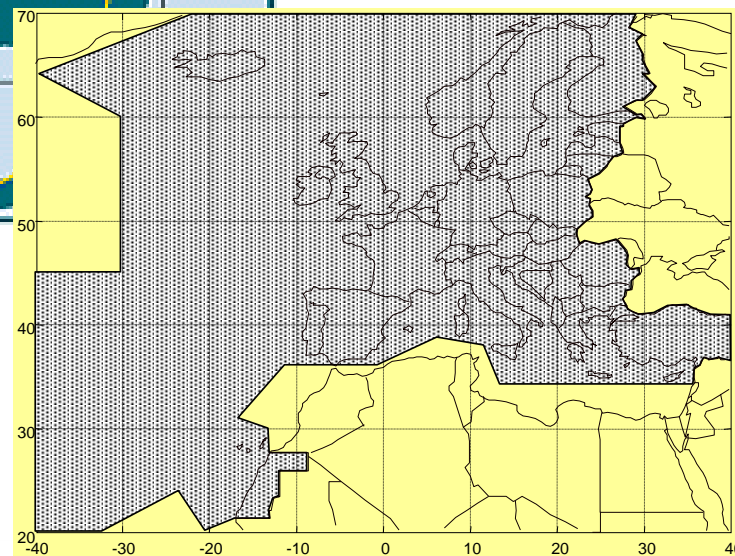

RNP APCH LPV – aircraft requirements

- SBAS is based on a network of several ground reference stations that covers the defined service area.
- Signals from GPS satellites are received by these ground reference stations. Each of them, precisely surveyed, receive GPS signals and determine if any errors exist.
- Each reference station in the network relays the data to a master station where correction information is computed.
- A correction message is prepared and uplinked to a geosynchronous satellite. The message is then broadcast from the satellite on the same frequency as GPS to receivers on board aircraft which are within the broadcast coverage area of the SBAS.
- These communications satellites also act as additional navigation satellites for the aircraft, thus, providing additional navigation signals for position determination.

RNP APCH LPV – aircraft requirements

EGNOS channel

AIP
FRANCE

AD2 LFRB IAC 09
03 MAY 12

APPROCHE AUX INSTRUMENTS

BREST BRETAGNE

Instrument approach

CAT A B C D

ALT AD : 325, THR : 289 (10 hPa)

RNAV (GNSS) RWY 07R

ATIS BRETAGNE : 129.350
 APP : IROISE Approche/Approach 135.825 (L)
 LANDI Approche/Approach 122.4 (L) pendant HOR activité de LANDI APP / During LANDI APP HOR of activity.
 TWR : BRETAGNE Tour/Tower 120.1

EGNOS
Ch 51177
E07A
RDH : 50

VAR
3° W
(10)

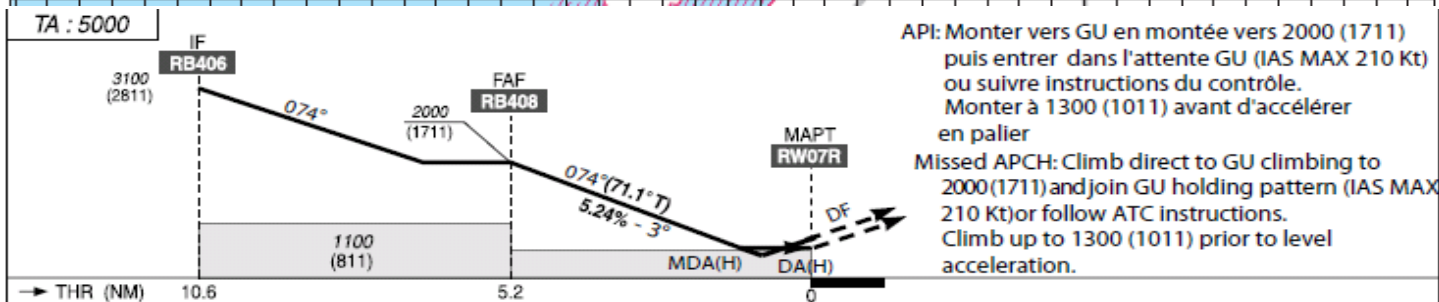

MNM AD : distances verticales en pieds, RVR et VIS en mètres. / Vertical distances in feet, RVR and VIS in meters. REF HGT : ALT THR

| CAT | LPV | | LNAV / VNAV OCH : 364 | | LNAV OCH : 367 | | MVL (1) | | DIST RW07R ALT (HGT) | 5 1930 (1641) | 4 1615 (1326) | 3 1295 (1006) | 2 975 (686) | 1 700 (410) |
|-----|-----------|------|-----------------------|------|----------------|------|-----------|------|-------------------------|---------------------|---------------------|---------------------|-------------------|-------------------|
| | DA(H) | RVR | DA(H) | RVR | MDA (H) | RVR | MDA (H) | VIS | | | | | | |
| A | 590 (300) | 1400 | 234 | 1500 | 780 (490) | 1500 | 780 (490) | 1500 | | | | | | |
| B | 590 (300) | 1400 | 243 | 1500 | 810 (520) | 1500 | 810 (520) | 1600 | | | | | | |
| C | 590 (300) | 1400 | | 1500 | | 1500 | | 2400 | | | | | | |
| D | 590 (300) | 1400 | | 1500 | | 1500 | | 3600 | | | | | | |

TMNM Baro -VNAV : -15 °C

APV SBAS (AMC 20-28)
Lateral guidance: GNSS + SBAS

RNP APCH LPV – aircraft requirements

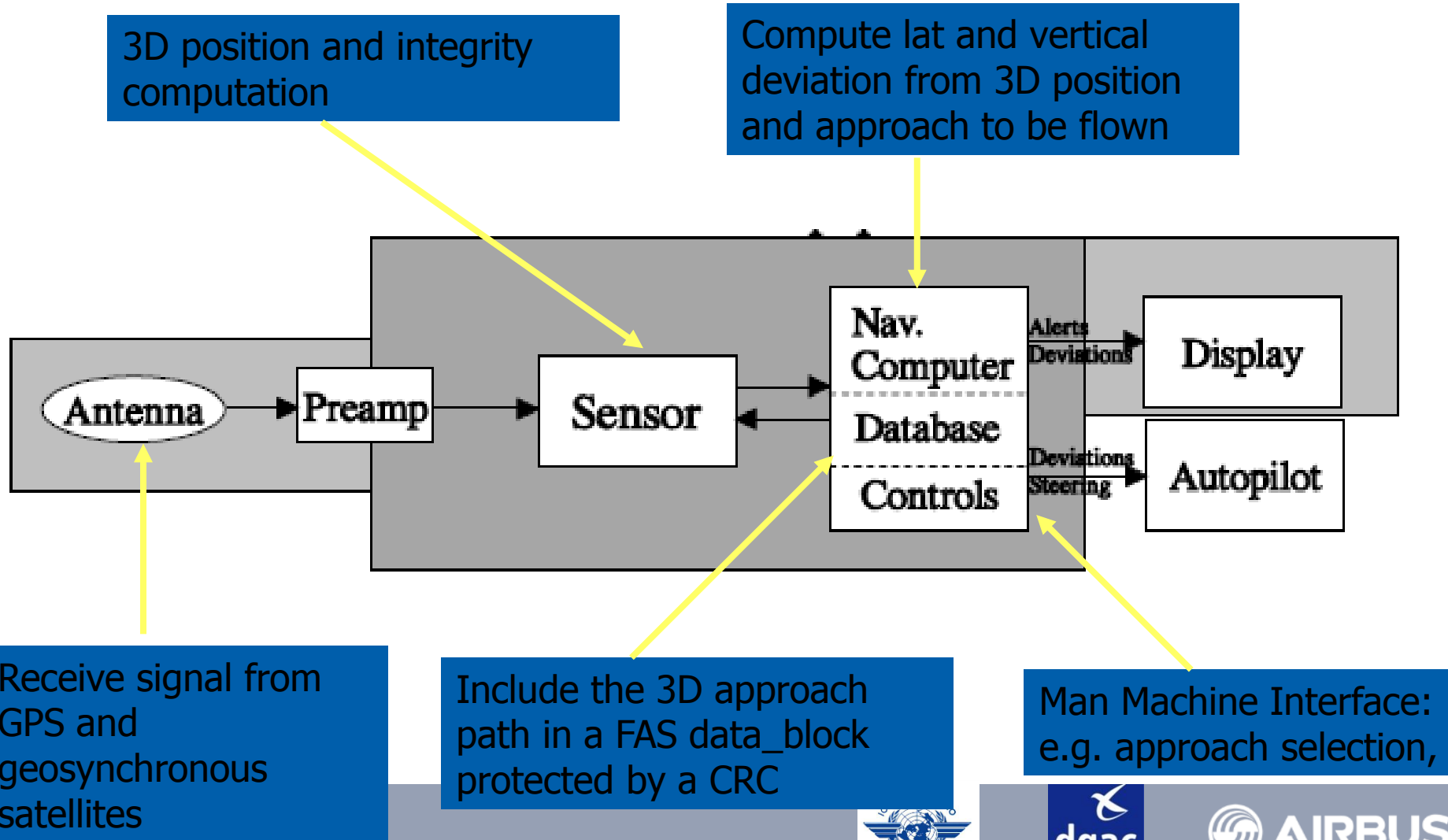

RNP APCH LPV – aircraft requirements

- Two Types of SBAS receiver:
 - “Standalone” system incorporating the receiver, the RNAV computer, the nav data base and the Man Machine Interface
 - SBAS sensor incorporating only the receiver part. Sensor must be connected to an integrated navigation system (ex FMS).
- The technical standard for the approval of these systems is the DO 229() (RTCA).
 - It specifies functional and operational classes.
 - It specifies technical requirements
- FAA and European regulation for equipment qualification standard based on DO 229():
 - E/TSO C146() for « stand-alone » receiver
 - E/TSO C145() for SBAS sensor.
- Regulation for SBAS aircraft certification:
 - FAA AC 20-138A/ 138C
 - EASA AMC 20-28 has been issued end of 2008 to address LPV operations.

RNP APCH LPV – aircraft requirements

- «Standalone» System (E/TSO C146a)
 - Functional classes:
 - **GAMMA** (receiver +RNAV +D/B+IHM)
 - Operational classes:
 - **1**: Oceanic, Enroute continental, terminal (arrival and departure), non precision approach
 - **2**: Operational class 1+ LNAV/VNAV
 - **3**: Operational class 2+ LPV
- SBAS Sensor (E/TSO C145a)
 - Functional Class:
 - **BETA** (receiver only)
 - Operational classes
 - **1**: Oceanic, Enroute continental, terminal (arrival and departure), non precision approach
 - **2**: Operational class 1+ LNAV/VNAV
 - **3**: Operational class 2+ LPV
- For LPV approach it is necessary to have :
 - A GAMMA class 3 stand-alone system or
 - A multisensor system integrating a BETA class 3 sensor

RNP APCH LPV – aircraft requirements

Integrity

The system shall indicate that the navigation system is no longer adequate to conduct a LPV approach by means of a warning flag or equivalent indicator on the vertical and lateral navigation display when the horizontal protection level (HPL) exceeds the alert limit (HAL) or when the vertical protection level (VPL) exceeds the alert limit (VAL).

Horizontal Alert Limit (HAL) and Vertical Alert Limit (VAL) are stored in the navigation database for the approach to be flown (FAS data Block)

Different GNSS Performance Levels

LNAV/VNAV → Basic GPS (lateral) + barometric (vertical)

APV I → SBAS: EGNOS, WAAS, MSAS, GAGAN

APV II → SBAS: EGNOS, Galileo

Cat I → GLS with GBAS or dual freq SBAS

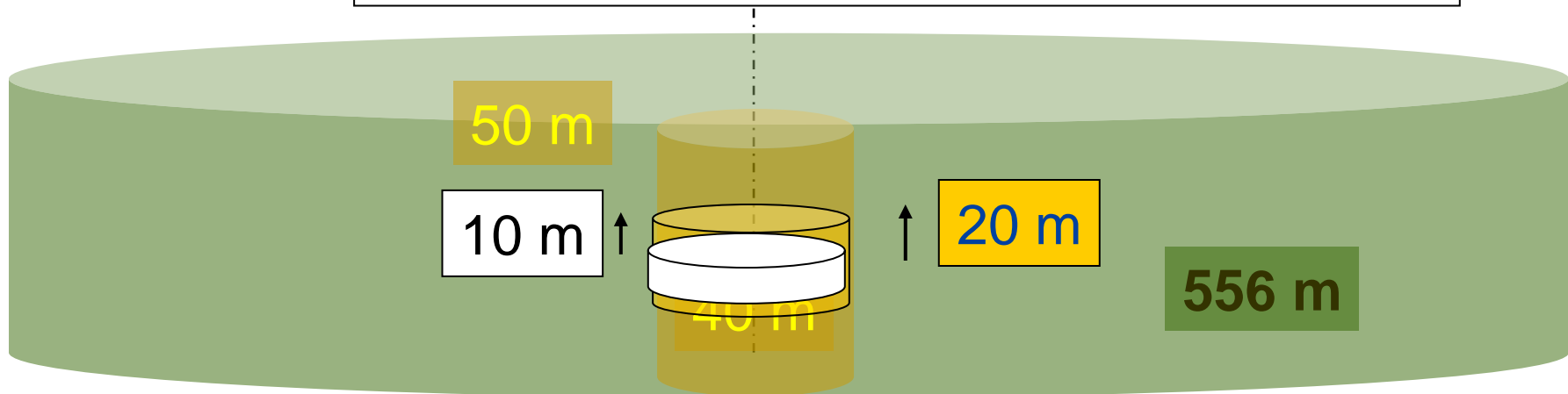

Sketch of relative Alarm Limit Box for the different GNSS Performance levels. Represents the containment of the uncertainty on aircraft position at 10-7 probability

RNP APCH LPV – – aircraft requirements

For Lateral and Vertical Navigation, the system enables the aircraft to fly relative to a 3D final approach path which is provided by the on-board navigation database.

The on-board navigation database element defining the LPV Final Approach Segment is the “FAS data block”. This FAS Data Block contains the lateral and vertical parameters, which define the approach to be flown. Each FAS Data Block ends with a CRC, which wraps around the approach data

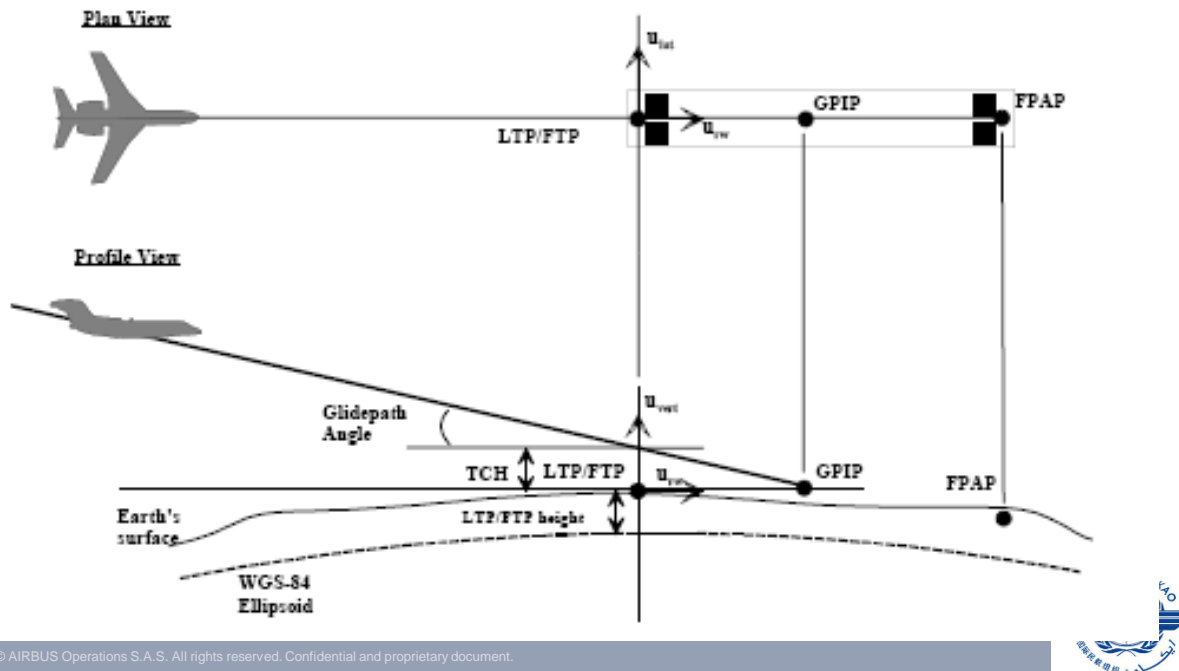

RNP APCH LPV – FAS data Block

BREST BRETAGNE

SBAS FAS BLOCK RNAV (GNSS) RWY 07R

| | |
|----------------------------------|---------------|
| Operation Type: | 0 |
| SBAS Provider: | 1 |
| Airport Identifier: | LFRB |
| Runway: | 7 |
| Runway Direction: | 1 |
| Approach Performance Designator: | 0 |
| Route Indicator: | |
| Reference Path Data Selector: | 0 |
| Reference Path Identifier: | E07A |
| LTP/FTP Latitude: | 482636.1500N |
| LTP/FTP Longitude: | 0042618.0600W |
| LTP/FTP Height (metres): | 138.7 |
| FPAP Latitude: | 482708.4500N |
| Delta FPAP Latitude (seconds): | 32.3 |
| FPAP Longitude: | 0042355.2700W |
| Delta FPAP Longitude (seconds): | 142.79 |
| Threshold Crossing Height: | 15.0 |
| TCH Units: | 1 |
| glidepath Angle (degrees): | 3 |
| Course Width (metres): | 105 |
| Length Offset (metres): | 0 |
| HAL: | 40 |
| VAL: | 50 |
| calculated CRC value: | E82D410E |

RNP APCH LPV – aircraft requirements

- The deviation display shall have a suitable full-scale deflection based on the required track keeping accuracy.
 - The lateral and vertical Full Scale Deflection are angular and dependant of the lateral and vertical definitions of the Final Approach Segment Path

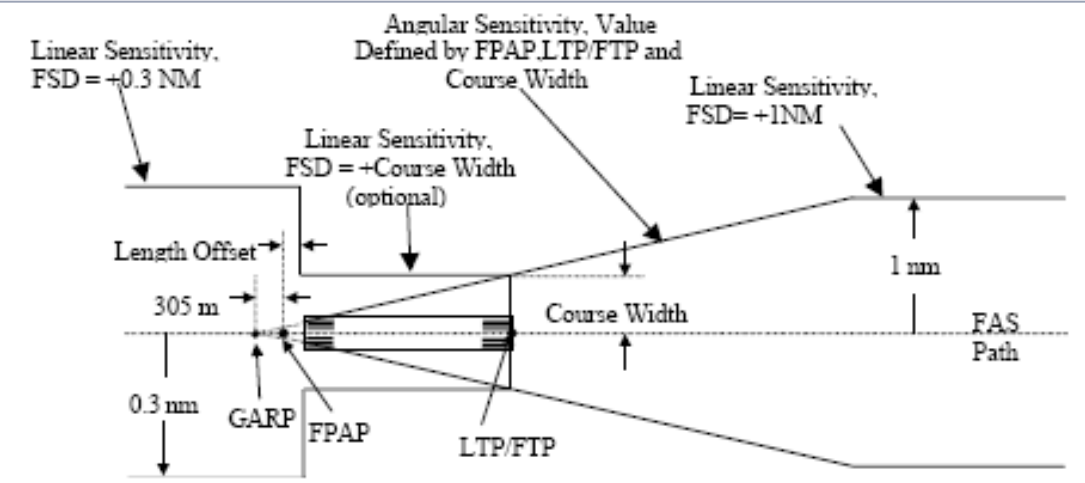

→ ILS Look Alike Concept

Lateral full scale deflection

Vertical full scale deflection

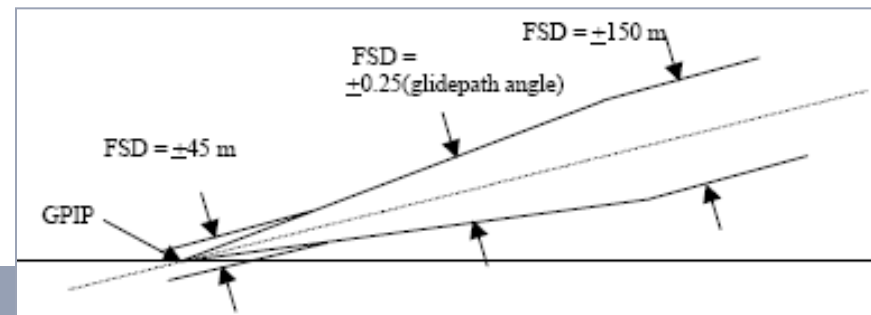

RNP APCH LPV – aircraft requirements

■ New HSI & GS annunciators:

| Flight Phase | Annunciation* | Auto CDI Scaling |
|------------------------------|---------------|--|
| Departure | DPRT | 0.3 nm |
| Oceanic | OCN | 2.0 nm |
| Enroute | ENR | 2.0 nm |
| Terminal Mode | TERM | 1.0 nm |
| Approach (Non-precision) | LNAV | 1.0 nm decreasing to 350 feet depending on variables |
| Approach (Vertical Guidance) | LNAV + V | 1.0 nm decreasing to 350 feet depending on variables |
| Approach (LNAV/VNAV) | L/VNAV | 1.0 nm decreasing to 350 feet depending on variables |
| Approach (LPV) | LPV | 1.0 nm decreasing to 350 feet depending on variables |
| Missed Approach | MAPR | 0.3 nm |

* Flight phase annunciators are normally shown in magenta, but when cautionary conditions exist the color changes to yellow.



RNP APCH overview

- RNP APCH introduction
- Airborne RNP APCH system performance
 - LNAV
 - LNAV/VNAV
 - LPV
- RNP APCH Operational approval process

RNP APCH – Operational approval process

- Approval process
- A/C eligibility
- Flight OPS Manual

RNP APCH – Approval Process

Public Transport

- To conduct an RNAV(GNSS) approach, the airline must have been approved by its supervisory authority. The AOC (Air Operator's Certificate) must refer to the approved operational capability per type of aircraft.

General aviation

Pilots holding licenses issued by DGAC

- Before conducting an RNAV(GNSS) approach, the aircraft must have been certified for this type of approach and the pilot must have undergone training approved by the DGAC in accordance with Technical guidelines for RNP APCH operations known as RNAV(GNSS).

Other pilots

- To conduct an RNAV(GNSS) approach, the aircraft and its crew must fulfill the directive of the authority issuing the pilot's license.

RNP APCH - A/C eligibility

Eligibility of the A/C is determined through the analyses of the AFM
RNP APCH LNAV

In the AMC 20-27 : chapter 8.3 Existing Installations

An existing statement in the AFM that indicates the aircraft is approved:

- To perform RNP 0.3 GNSS approaches or,
- For instrument approaches including a specification of RNP GNSS capability that meets RNP 0.3

=> is considered acceptable for lateral performance.

RNP APCH LNAV/VNAV – A/C eligibility

RNP APCH LNAV / VNAV

- No such statement in the AMC 20-27.
- No harmonization between EASA and FAA
- Performance requirements for the vertical TSE more stringent than those in AC 20-129 and PBN manual.
- DGAC considers the following chapter from AMC 20-27 :

An acceptable means of complying with the above accuracy requirements is to have the VNAV system approved for RNAV approaches in accordance with FAA AC 20-129 and to provide evidence that the FTE, or VTSE, or operation procedures to bound the FTE are within the required limits.

- Vertical deviation has to be clearly shown either on PFD or ND (monitoring on MCDU or CDU of numeric vertical deviation not accepted)

RNP APCH LNAV/VNAV – A/C eligibility



Example of Management of lateral and vertical deviations

- Lateral
 - PNF announces “cross track” when 0.2Nm of deviations
 - PNF announces “go around” when 0.3Nm of deviations
- Vertical
 - PNF announces “VDEV” when 1/2 dot of deviation (50’)
 - PNF announces “go around” when 3/4 dot of deviation (75’)
- Use of the FD is mandatory
- Use of AP is recommended

RNP APCH LNAV /VNAV – A/C eligibility

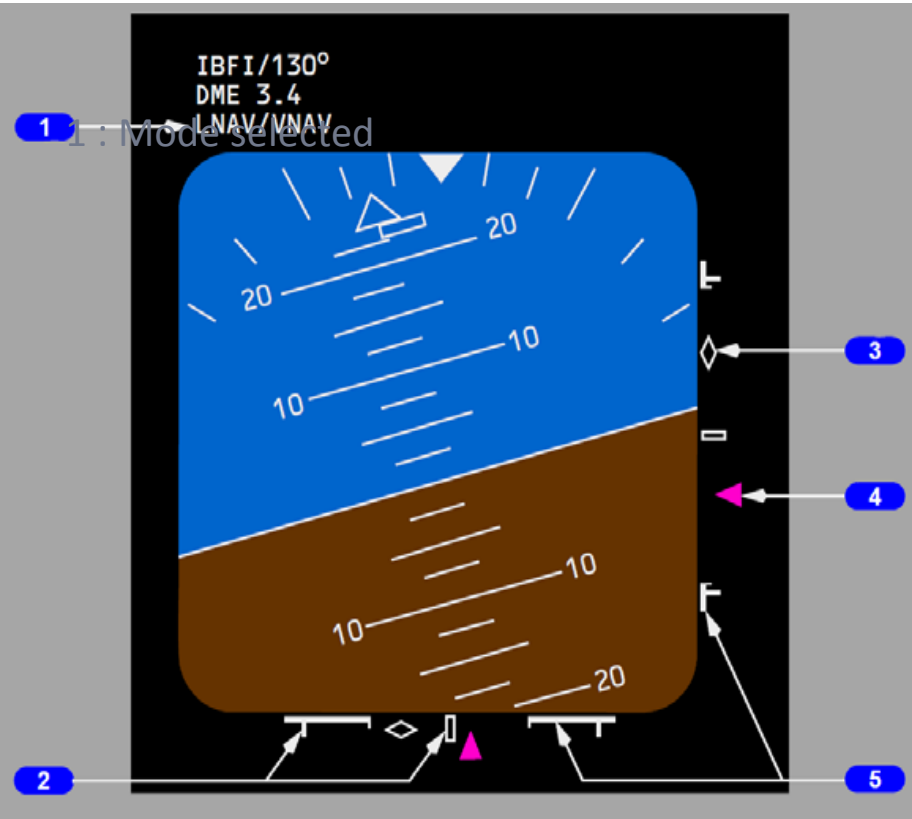

4 : NPS deviation Pointer
Indicates the navigation path
relative to airplane position

2 and 5 : Deviation scale

- Lateral and Vertical Scales

- Outer white lines represent RNP. Center white line represents position

- Bars represent ANP

- Area between bars indicates margin available to remain within RNP criteria

RNP APCH LPV– A/C eligibility

- For LPV : AFM must mentions compliance to AMC 20-28

RNP APCH - Application – CONTENT OF FLIGHT MANUAL

- AFM specifying the RNP capability of the aircraft to determine Aircraft eligibility for RNP APCH
- OPS Manual shall contain
 - A description of the operation of the RNAV/GNSS navigation system used.
 - pre-flight planning procedures.
 - normal procedures in flight.
 - contingency procedures.
 - Database integrity monitoring policy.
 - Flight crew training requirements.
 - All operators must also amend the check-lists, QRH and Minimum Equipment Lists (MEL) (or the document used for this purpose in general aviation) in order to incorporate the use of RNAV/GNSS equipment for this type of approach.

Operational approval - Pre-flight planning

- The flight plan has to be filled in in accordance with the capability.
- The navigation database has to be current
- Selection of aerodromes

INA Initial and intermediate approach can be RNAV1

- Check appropriate approval

RNAV(GNSS) and alternate aerodrome

- If no alternate destination aerodrome: the destination aerodrome must be accessible by means of a conventional approach (non RNAV(GNSS)).
- If at least one alternate aerodrome is required : The alternate aerodromes must be accessible by means of a conventional approach (non RNAV(GNSS))
- An RNAV(GNSS) approach cannot be used to select an alternate aerodrome at take-off.
- For APV SBAS (LPV), the previous requirements apply, unless the airspace authority concerned does not so require. These requirements apply in French airspace.

Operational approval - Pre-flight planning

- Check the MEL
- GNSS coverage and availability of the RAIM function (or equivalent)

Check GNSS NOTAMs

- GPS NOTAMs: concerning the operating status of the GPS constellation.
- RAIM NOTAMs: supplied for each aerodrome for which an RNAV (GNSS) approach is published, leading to LNAV or LN AV/VNAV minima.
- SBAS NOTAMs: concerning the unavailability of the LPV procedure with regard to the performance of the SBAS system. These NOTAMs are supplied for each aerodrome for which an RNAV (GNSS) approach leading to LPV minima is published. (EGNOS NOTAM in Europe)

Operational approval - Pre-flight planning

➤ For an LNAV or LNAV/VNAV approach

Check RAIM availability at the estimated time of arrival (ETA) +/-15 minutes,

- RAIM prediction NOTAMs or
- the on-board equipment prediction tool

insert satellite unavailability info into the predictive programme

- if (ETA) differs by more than 15 minutes => Check again RAIM before starting the approach,
- For some avionics architectures, RAIM prediction may only be required in certain cases (depending on the availability of the constellation) report to the AFM.

Operational approval - Pre-flight planning

➤ For an LPV approach

Check the SBAS NOTAMs (in Europe EGNOS NOTAMs) for availability of the approach.

No RAIM prediction is required,

- integrity is managed directly by the SBAS geostationary satellites.

RNP APCH - Normal procedures

Prior to commencing the approach procedure

Before the IAF, the pilot shall check that the correct procedure, including missed approach, has been loaded.

Check flight path displayed on the navigation screen (ND, MFD,..) against the approach chart

- The sequence of the various waypoints
- The reasonableness of the tracks and distances of the segments, length and route.
- The final angle of descent in the case of APV BaroVNAV, LPV approaches, or if the (Baro) VNAV function is used.

3.3 Vérification d'une procédure RNAV

La base de données de navigation est l'élément de référence du système RNAV, c'est un point critique en navigation RNAV et la réglementation nous oblige à en vérifier la conformité avant chaque procédure. Cela se traduit opérationnellement par la comparaison entre les cartes de navigation et la base de données FMC au moyen du CDU et de L'EHSIND.

Utiliser la page LEGS du CDU avec l'EHSIND en mode PLAN avec une échelle suffisamment faible pour bien visualiser la procédure.

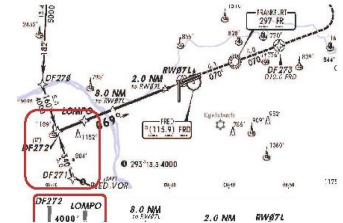

RNP APCH – Normal Procedure

Monitoring of the FTE

- The Lateral deviation must be limited to half the RNP
 - 0.15Nm on the final approach segment,
 - 0.5Nm on the intermediate segments.
- The vertical deviation should be limited to 75 ft in the case of APV Baro VNAV
- Brief overshoots are tolerated, in particular during and just after turns.

RNP APCH – abnormal procedures

- Develop simple procedures in accordance with the RNAV system, alarms and displays

to cover the cases for which the procedure must be discontinued

- Loss of the function checking the position integrity or position error alarm (e.g.: GPS Primary loss, Unable RNP, RAIM loss/not available, RAIM position error/alert, etc.)
- Suspected database error.
- Discrepancy between the two RNAV/GNSS devices for an installation certified with two systems.
- Excessive FTE (excessive deviation on the lateral deviation indicator)
- excessive deviation on the lateral deviation indicator

UNABLE REQD NAV PERF - RNP

Condition: UNABLE REQD NAV PERF-RNP is shown. The actual navigation performance is not sufficient.

1 Choose one:

◆ On a procedure or airway with an **RNP alerting requirement**:

Select an alternate procedure or airway. During an approach, go-around unless suitable visual references can be established and maintained.

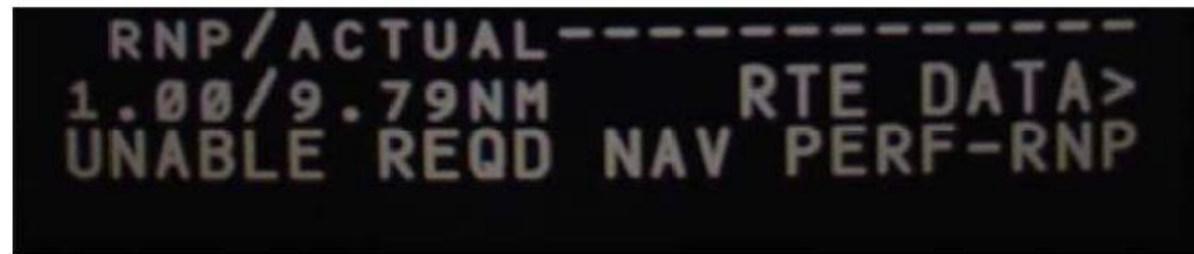

RNP APCH Contingency procedure

If the missed approach path is a RNAV procedure and if the loss of RNAV guidance during the approach does not allow to follow the

missed approach procedure provided for the considered runway.

=> a contingency procedure should be defined

- This contingency procedure will consist in following a dead reckoning path, allowing to reach a sufficient altitude and taking into account:
 - obstacles
 - aircraft performance
 - airspace restrictions

Example of a « contingency procedure »

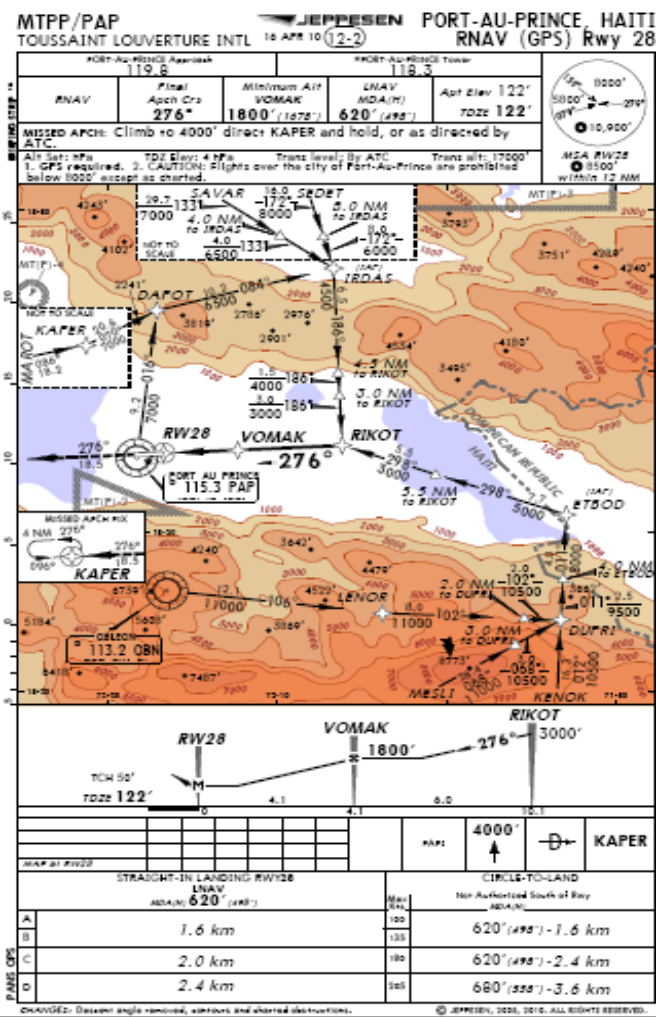

Courtesy translated:

Approach RNAV (GNSS) Rwy 28

Missed approach following the loss of RNAV/GNSS function

Extraction procedure :

- climb to 4000 ft, turn to heading 276°.
- Contact ATC for instruction

RNP APCH - Navigation Database

CAT.IDE.A.355 (Electronic navigation data management) applies

Navigation data base integrity

- Shall comply with ED 76/DO 200A methodology standard or an equivalent approved procedure => LOA type 2 and type 1

Quality Monitoring

- The operator should continue to monitor both the process and the products in accordance with the quality system required by the applicable operational regulations.

Data Distribution

- The operator should implement procedures that ensure timely distribution and insertion of current and unaltered electronic navigation data to all aircraft that require it.

Feed back and reporting errors found

- significant errors (i.e. those that would affect the flight path of the aircraft) should be reported to the database supplier and the competent authority
- Affected procedures should be prohibited by a company instruction or NOTAM.

RNP APCH – reportable events

Any significant incidents experienced during RNP APCH procedures have to be reported

- a) Significant navigation errors attributed to incorrect data or a data base coding error.
- b) Unexpected deviations in lateral/vertical flight path not caused by pilot input.
- c) Significant misleading information without a failure warning.
- d) Total loss or multiple navigation equipment failure.
- e) Loss of integrity (e.g. RAIM) function whereas integrity was predicted to be available during the preflight planning.

RNP APCH – special procedures

- RNP APCH procedures with particularities (e.g. deviations from the international procedure design standards) => Define criteria
- Analyse the particularities and any special requirements published in the AIP.
 - It may require an operational evaluation of such procedure in VMC conditions or in simulator (FFS : Full flight simulator)
 - to evaluate the controllability of the procedure and
 - detect any incompatibilities between the coding of the procedure and the aircraft performance.
- Development of an additional pilot training programme to take account of those particularities
- The operator should develop methods and tools to detect that kind of complex procedures, and gives appropriate directive for the crew.

RNP APCH – Flight crew qualification and training

Content of the training

- Before performing RNAV(GNSS) approaches, the pilots must be familiar with
- the basic principles, limitations and special functions of the RNAV/GNSS system.
- with the operation and particularities of the RNAV/GNSS equipment installed on the aircraft.
- they should be aware of the operational procedures applicable to pre-flight planning and performance of these approaches.

- The minimum training shall comprise a theoretical part and a practical part.
- Each shall be dispensed in accordance with a programme approved by the authority.

RNP APCH – Flight crew qualification and training

The operator shall define the risks and threats linked to the type of procedure (TEM, Threat and Error Management)

- Barometric error
- Effect of temperature
- Identification and visualisation of the vertical profile
- Situation of the aircraft in space (BaroVNAV profile vs ILS look alike profile)
- Equipment deterioration
- Change in approach type (LNAV, LNAV/VNAV, LPV)
- Presentation of information
- Navigation Database error
- etc.

RNP APCH – Flight crew qualification and training

Academic Training

- Characteristics , functionalities, limitations of the RNAV/GNSS equipment used, including alarms and error messages.
- Characteristics of RNP APCH approach procedures.
- pre-flight planning (selection of aerodromes, NOTAMs, RAIM prediction).
- Normal and contingency procedures, (including phraseology).
- Manual or automatic holding pattern procedures.
- Databases (characteristics, checks and use).
- charts, identification of the approach procedure, representation and characteristics of the various turning points,....

RNP APCH – Flight Crew Qualification and Training

Crew must be familiar with the Phraseology

TECHNICAL GUIDELINES 01 PBN
20
Guidelines for RNP APCH operations also known as RNAV (GNSS)

EDITION N°2

7.3 PHRASEOLOGY ASSOCIATED WITH RNAV(GNSS) APPROACHES

In terms of phraseology, no distinction is made between the different types of RNAV(GNSS) approaches (no distinction according to LPV, LNAV/VNAV, or LNAV minima)

From the first radio contact with the approach control unit, RNAV approach clearance is requested by the pilot after checking that it can be carried out.

- Basic phraseology used by the pilot and ATC to perform an RNAV(GNSS) approach to runway 26:
 - Pilot:** Clermont approach, Regional QB, we request an RNAV approach on runway 26
 - ATC:** Regional QB, Clermont approach, RNAV approach authorized on runway 26
- Phraseology in case of loss of RNAV capability:
 - Pilot:** AFR 070, RNAV impossible due to equipment
- Pilot/ATC phraseology in case of radar guidance followed by a final RNAV (GNSS) approach
 - Pilot:** De Gaulle approach, AFR070, we request [final] RNAV approach on right runway 08
 - ATC:** AFR070, De Gaulle approach, leave BALDD heading 030, radar guidance for [final] RNAV on right runway 08.

Then

 - ATC:** AFR070, De Gaulle, turn right heading 060, descend to 4000ft QNH 1026, [final] RNAV approach authorized on right runway 08.
- Pilot/ATC phraseology in the event of initial and intermediate RNAV1 approach (ODRAN 1A in the example) with an identifier followed by an RNAV(GNSS) final approach
 - Pilot:** Orly approach, AFR070, we request [final] RNAV approach on runway 06
 - ATC:** AFR070, Orly approach, ODRAN 1A for [final] RNAV authorized on runway 06

Then

 - ATC:** AFR070, Orly approach, [final] RNAV approach runway 06

RNP APCH – Flight crew qualification and training

Radar guidance limitations

- Guidance leading to interception of the final axis less than 2NM before the FAF should not be accepted.
- Manual input of user WPt into the GNSS system by the pilot for use in the terminal area is not authorised.
- "Direct to" clearances to the IF can be accepted provided that the resulting track change does not exceed 45°
- "Direct to" clearances to the FAF must not be accepted.
- "Direct to" clearances to a waypoint which does not belong to the procedure must not be accepted.

RNP APCH – Flight crew qualification and training

USE OF BARO VNAV – ASSOCIATED RISKS, PRECAUTIONS FOR USE

Importance of specific crew procedures

There are two possible situations for using the (Baro) VNAV function:

- Either to manage the vertical plane of non-precision approaches (to help with CDFAs)
- to carry out an APV BaroVNAV (required function)

In both cases, the pilots must take the usual precautions

- Altimetry setting
- Temperature limitations

RNP APCH – Flight crew qualification and training

Altimeter setting.

- Flight Crews should take precautions to switch altimeter settings at appropriate times or locations
- request a current altimeter setting if the reported setting may not be recent, particularly at times when pressure is reported or is expected to be rapidly decreasing. (for instance before FAF)
- Remote altimeter setting is prohibited: A current altimeter setting for the landing airport is required.

Consolidation of Baro-altitude performance during the approach

- Two primary altimeter systems are necessary
- Crew requirements for vertical guidance comparisons with regards to primary altimeter information, altitude crosschecks (e.g. altimetry comparisons of 100 feet), temperature limitations and procedures for altimeter setting.

RNP APCH – Flight crew qualification and training

- The pilots must know that the vertical flight path in Baro VNAV is influenced by altimeter setting errors. These errors may not be detected by a cross-check between the altimeter reading and the values given on the approach chart (altitude – distance verification).

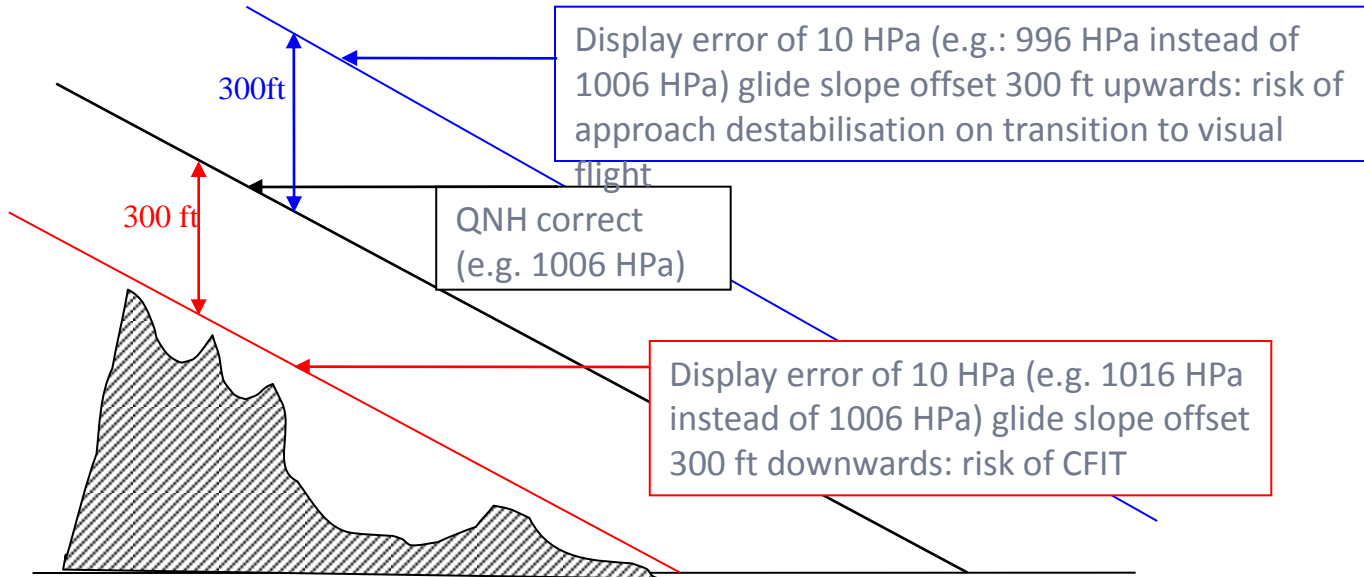

RNP APCH – Flight crew qualification and training

- To strictly respect temperature limitation
 - When cold weather temperatures exist, the pilot should check the chart for the instrument approach procedure to determine the limiting temperature for the use of Baro-VNAV capability. If the airborne system contains a temperature compensation capability, manufacturer instructions should be respected.

RNP APCH – Flight crew qualification and training

Effect of temperature

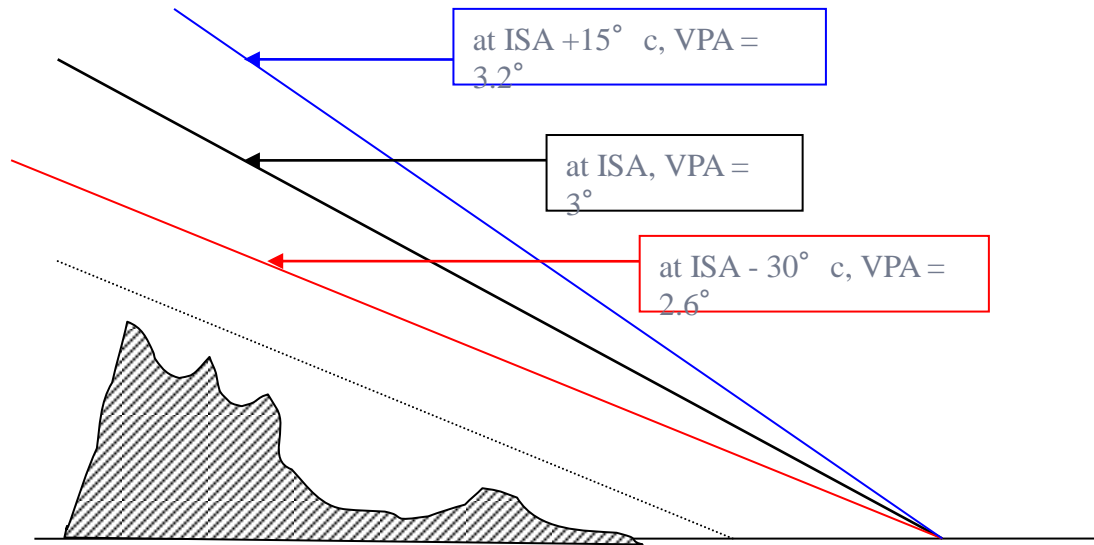

Example of the effect of temperature on a BaroVNAV vertical profile for an aerodrome situated at sea level. For a nominal slope (black line) of 3° , the actual slope will be 2.6° for ISA -30 (red line) and therefore closer to any obstacles, and will be 3.2° for ISA+15° (blue line) and thus steeper.

RNP APCH – Flight crew qualification and training

Certain charts can publish descent markers (step down fix - SDF) to clear obstacles by procedure.

Pilot check that when approaching 3.3 Nm he is not below 1100ft (applicable Only for LNAV)

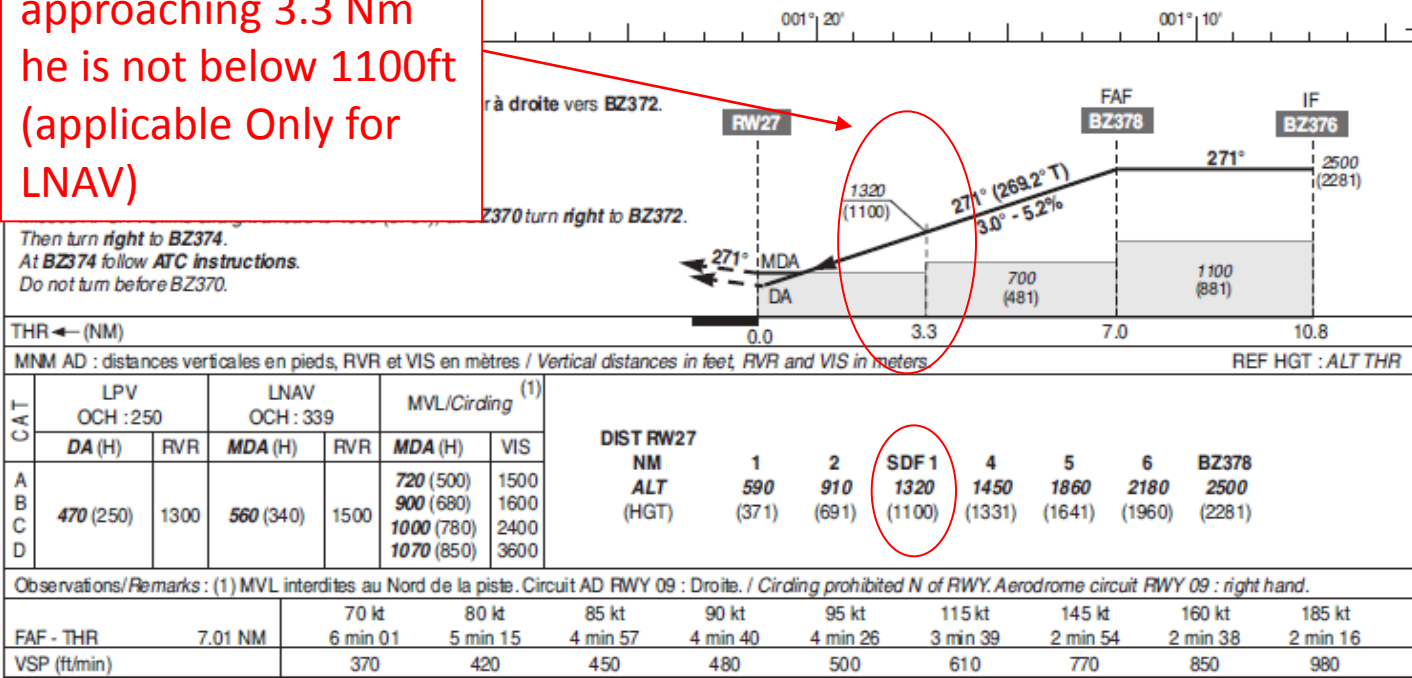

Practical training 1/2

- Ground Practical training.
 - lasts a minimum of two (2) hours,
 - cover the utilisation of an RNAV/GNSS navigation system comparable to that installed on the aircraft.
 - For the purposes of this training, the equipment used may be presented or installed on a computer, a simulation bench, an FSTD (flight simulation training device), or an aircraft on the ground.

RNP APCH – Flight crew qualification and training

Practical training 2/2

- Practical training in-flight or on an FSTD
 - either on an aircraft of the same type as that used operationally;
 - or on a simulator, representative of the aircraft used operationally.
- In both cases, the RNAV/GNSS equipment used shall be comparable with that used operationally.
- This training shall comprise at least four (4) RNAV(GNSS) approaches.
- Two (2) of them with a discontinuation of the approach because of a simulated failure (loss of RNAV capability or RAIM alarm for example), followed by a missed approach.

RNP APCH – Flight crew qualification and training

Recurrent training - Additional requirements for public air transport pilots

- The operator shall ensure that each pilot undergoes a check before conducting this type of approach. This check can be replaced by satisfactory training on an FSTD and/or in-flight.
- RNAV(GNSS) approaches have to be included in the recurrent training and checking programmes (required by section OPS 1.965 for CAT), with the same requirements as those concerning conventional non-precision approaches.
- The recurrent training and checking programme shall comprise theoretical refresher training, experience feedback and a sufficient number of RNAV (GNSS) approaches to ensure that the pilot's proficiency is currently satisfactory.

RNP APCH – Flight crew qualification and training

Attestation

- The head of the organisation dispensing the training will certify complete and satisfactory performance of the training by each pilot. The pilot may have to present without undue delay, his attestation upon request by an authorised representative of DGAC.