



**APEX**™ AIRPORT  
EXCELLENCE  
IN SAFETY

WORKING TOGETHER TO ENHANCE  
AIRPORT OPERATIONAL SAFETY

A blue-tinted photograph of an airport runway at night, viewed from an elevated perspective looking down the center. The runway is illuminated by a central line of lights and side lights, with crossbars visible. The background shows a dark sky and some distant lights.

Presented by: Juan Manuel Manriquez  
ICAO Workshop, Mexico City  
Date: 26 to 29 June 2018

## ACI WORLD AND REGIONAL OFFICES

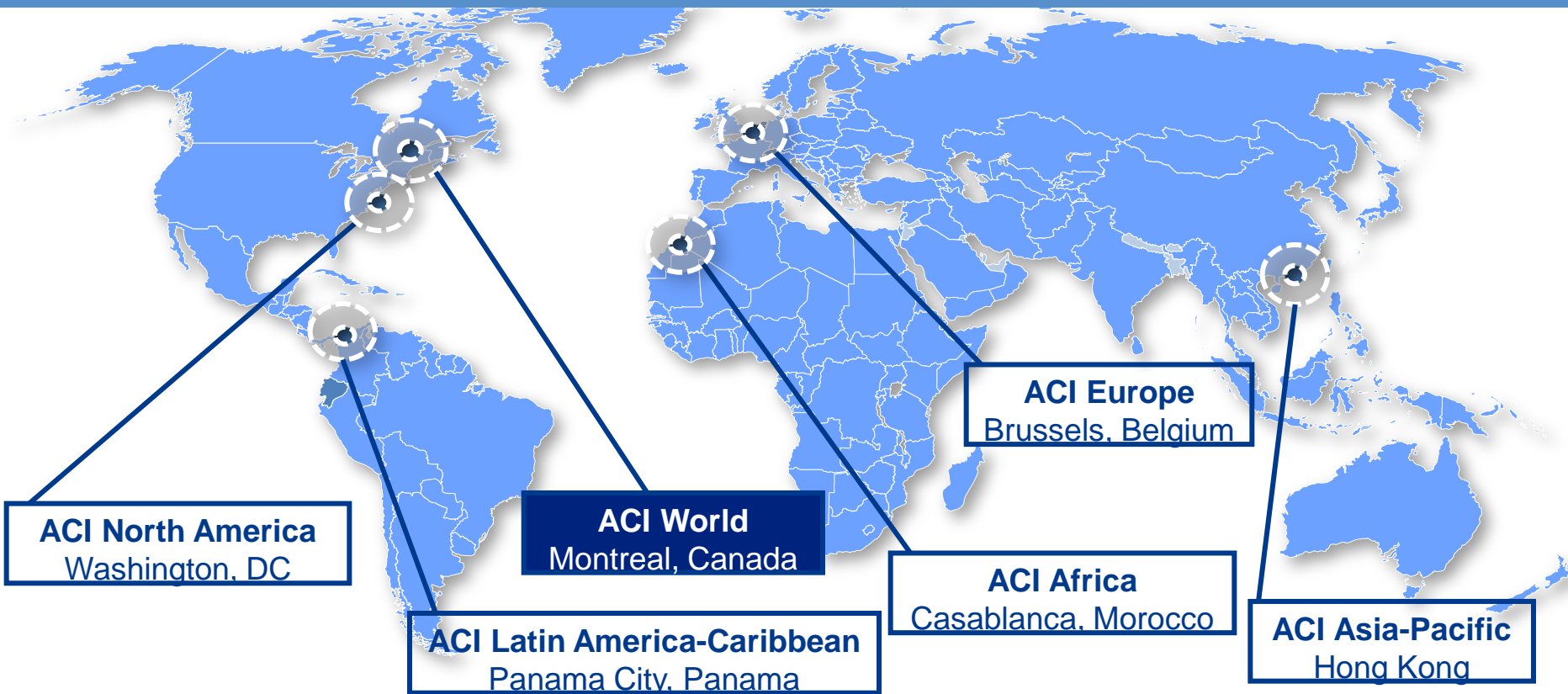

**Global Issues and Regulatory Bodies**

**Regional Issues and Regulatory Bodies**



### Safety

- Support ICAO on Annex 14 through the Aerodromes Panel
- Work on Annex 19 through the Safety Management Panel
- Develop best practices for Aerodrome Safety



### ACI Developing Nations' Airports (DNA) Assistance programme

- Provides workshops, subsidized training and financial assistance for capacity-building activities for ACI members in developing nations
- Past seminar topics include Safety Management Systems, Security Quality Control and Airport Economics



### Security

- The ACI World Security Standing Committee provides technical and policy guidance (e.g., LAGs, human factors and innovation in technology)
- Task forces provide detailed guidance on issues such as next-generation screening and facilitation
- ACI is working with IATA on Smart Security. A joint paper to the ICAO Aviation Security Panel was well received



### Promoting Airport Excellence in Service Quality (ASQ)

- ASQ is the world's largest airport passenger satisfaction survey
- 300 airports - >400,000 passengers interviewed per year
- 34 parameters measuring passenger satisfaction with facilities and services provided
- Measuring passenger satisfaction is increasingly important for economic regulators



### Airport Environmental Sustainability

- The ACI World Environment Committee provides technical and policy guidance to help airports maintain harmony with their communities
- Reduce impacts of aviation re noise, emissions, air and water quality
- Airport Carbon Accreditation programme certifies airport achievement in reduction of carbon output



### Airport Information Technology

- Optimizing the use of new technologies and protocols that achieve service improvements and cost efficiencies in airport processes
- Identifying best practices in the use of information and communication technology at airports
- Launched the ACI Airport IT Security Programme
- Participates at ICAO's MRTD



### Economics and Statistics

- World's largest coverage of airport traffic and economic data:
  - Traffic: 2,300 airports worldwide
  - Economics: 800 airports worldwide
- Customized, monthly and yearly traffic data reporting
- Traffic forecasting by country and world region



### ICAO Relations

- ACI seeks to build relations with ICAO at the Council, State and Secretariat and Regional levels
- ACI is a permanent Observer on the Air Navigation Commission
- ACI members and staff serve on ICAO committees, panels, working groups and task forces



### Global Training

## THE NEED FOR AIRPORT EXCELLENCE IN SAFETY (APEX)

- **ICAO Safety Audit Program (USOAP) results demanded an industry response**
- **APEX is ACI's response to the call-to-action to improve aviation safety worldwide**
- **Original Vision focused on supporting airports in developing countries with:**
  - Compliance with international standards
  - Aerodrome certification
  - Safety Management System (SMS) implementations
  - Training and Capacity development
- **Developed airports also recognized the opportunity and benefits of validating safety performance through peer reviews**

## AIRPORT EXCELLENCE IN SAFETY (APEX)

### Quick Facts:

- APEX was developed to support airports in identifying and mitigating safety vulnerabilities through peer reviews
- Provides guidance and facilitates improvements through mentoring, training and best practice exchanges to address identified gaps across entire operation
- Based on ICAO Annex 14 Standards and Recommend Practices (SARPS) and ACI Best Practices
- Cost recovery basis only, transportation and hospitality covered by Host airport and Safety Partners donate Safety Assessor time

## AIRPORT EXCELLENCE IN SAFETY (APEX)



- APEX was developed to support airports in identifying and mitigating safety vulnerabilities through peer reviews
- Provides guidance and facilitates improvements through mentoring, training and best practice exchanges to address identified gaps across entire operation
- Based on ICAO Annex 14 Standards and Recommend Practices (SARPS) and ACI Best Practices
- Cost recovery basis only, transportation and hospitality covered by Host airport and Safety Partners donate Safety Assessor time



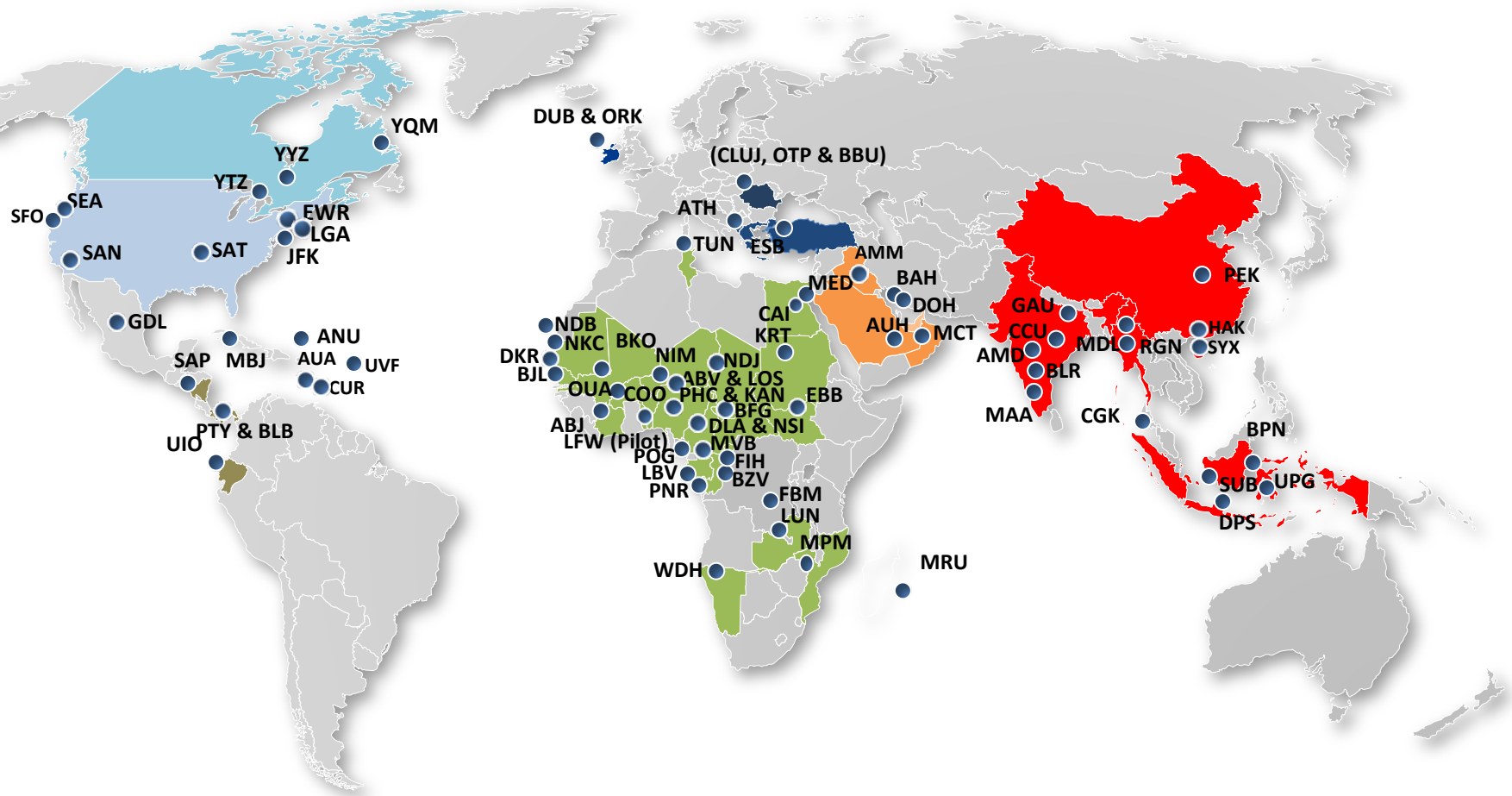

## APEX: 5 days review



### Aircraft Rescue and Firefighting:

Rescue and Firefighting; Emergency Response; Hazardous Material Handling; Training; Fleet Management; Breathing Apparatus and Personal Protective Equipment



## APEX: 5 days review



**Documentation:** Safety Management Systems; Aerodrome Certification; Validation of Aeronautical Information Publications Documentation; Airside Driver and Vehicle Management; Management of Ground Handlers; Removal of Disabled Aircraft; Standard and Operating Procedures



## APEX: 5 days review



**Physical Characteristics and Visual Aids:**  
Runway Safety; Markings, Signs and Lighting;  
Aerodrome Certification; Pavement  
Management; Low Visibility Operation  
Procedure; Obstacle management; Winter  
Operations; Foreign Objects Debris  
management; Movement Area Maintenance;  
Movement Area Access; Aerodrome Works  
Safety; Apron Safety management; Creation of  
Local Runway Safety Team



## APEX: 5 days review

### **Apron Management:**

Apron design, apron works, ground handling, inspections, audits, airside vehicle driving programme, apron floodlighting, slot allocation, safety culture, apron management, FOD, etc.



## APEX: 5 days review

**Wildlife Management:** Wildlife Management Plan; Vegetation Control; Waste Management and Food Sourcing; Wildlife Habitat Management Plan; Risk Management; Wildlife Dispersal Techniques



## POST-REVIEW ASSISTANCE



- Assistance in developing an action plan
- Custom ACI services such as workshops and training
- Assistance with risk assessment and quality management systems
- Continuous access to an international network of expertise

# Apron Management





The perfect airport does not exist

- Aprons are often the most congested and busiest areas of an airport. They are home to demanding and complex activities that are carried out under severe space and time constraints.
- Airport Operations personnel will probably spend the majority of their time dealing with Apron issues rather than Runway/Taxiway issues, however, apron areas are the least regulated. Globally, there are no uniform regulations.
- ACI provides guidance material and best practices for apron management.

Some of the available SARPs and Guidance Material:

- ACI Apron Safety Handbook, First Edition 2015
- Apron Markings and Signs Handbook, Third Edition 2017
- Managing Operations During Construction, First Edition 2018
- ICAO Annex 14
- ICAO Doc 9157 Part 4 (Chapter 2 for Markings and Markers, Chapter 12 for VDGS)
- ICAO Doc 9157 Part 2
- ICAO Doc 9137 Part 8
- ICAO Annex 2 for aircraft marshalling (3.4 and Appendix 1)
- ICAO Manual on Ground Handling (draft)

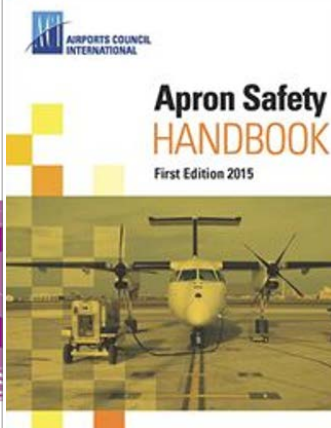
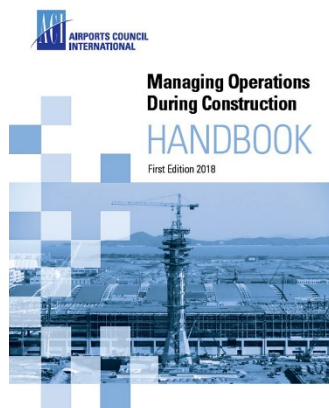



## Demand Forecast

- Forecasts of peak demand and the types and numbers of aircraft likely to use the airport in the future, including the evolution of aircraft types, are the most important factors when determining apron requirements.

## Inventory of Existing Facilities

- Existing apron facilities should be inventoried to provide a basis for understanding the capacity and the physical and operational characteristics of the existing facilities, as well as any constraints.

## Identification of Stakeholders' needs

- Stakeholders' needs for new apron space or for modification/reconfiguration of an existing apron should be identified in this process.
- The goal of the process is to define the apron planning and design objectives as clearly and with as much detail as possible.

## Apron Requirements

- The functional and operational requirements for the apron should be defined. Coordination with stakeholders is also important to ensure that all user needs are considered and incorporated into the requirements.

## Alternative Development and Evaluation

- Once the apron requirements have been determined, different options to meet the requirements should be developed. These should consider the apron operation, impacts on adjacent facilities, and other criteria and guidelines. All options should be further evaluated to refine the preferred options at an appropriate level of detail for implementation.

## Environmental Considerations

- Potential environmental impacts should be identified and documented.
- Statutory environmental reviews and permits may also be necessary.

- “Since the end of the Great Recession in 2009 to early 2010, global passenger traffic has been growing at an average rate of 5.5% annually—a testament to air transport’s resilience”.
- “In 2016, airports located in emerging and developing economies occupied 45% of global passenger traffic across the world’s airports and by 2040 this share is expected to increase to 62%. By that time, passenger throughput at airports in emerging and developing economies will have 1.6 times the passenger traffic of airports in advanced economies”

Global passenger traffic forecast: emerging versus advanced economies (2006–2040)

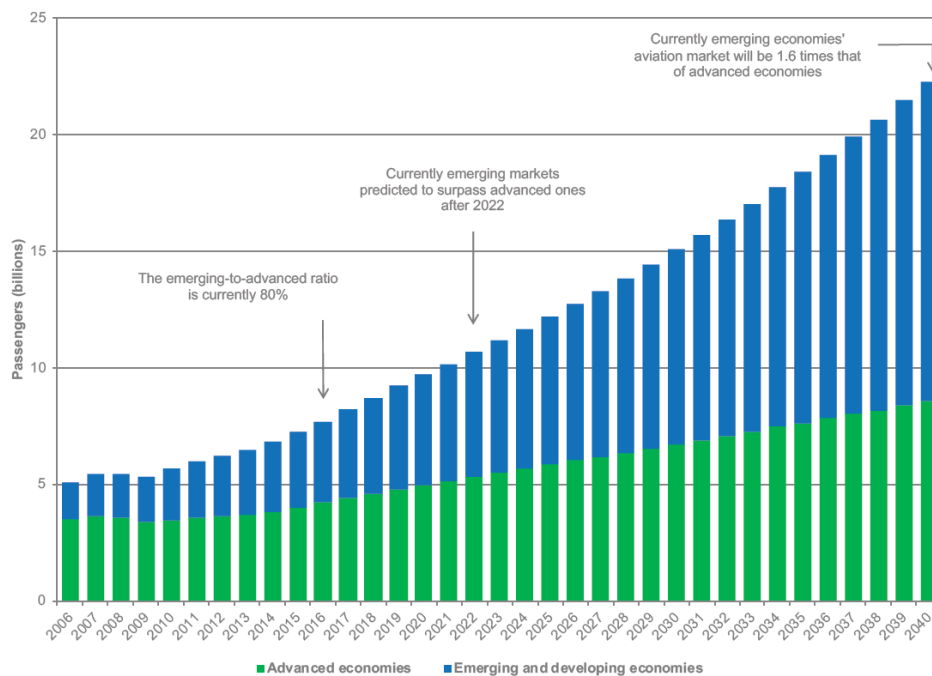

Source: ACI World Airport Traffic Forecasts 2016–2040

		2016 (current)	2026 (next 10 years)	2031 (next 15 years)	2036 (next 20 years)
World	Volume	7.7 billion	12.7 billion	15.7 billion	19.1 billion
	Compounded Annual Growth Rate (CAGR) %	-	5.2	4.9	4.7
Latin America-Caribbean	Volume	588 million	1.0 billion	1.3 billion	1.7 billion
	Compounded Annual Growth Rate (CAGR) %	-	5.5	5.5	5.4
Mexico	Volume	125.5 million	227.0 million	298.3 million	385.9 million
	Compounded Annual Growth Rate (CAGR) %	-	6.1	5.9	5.8



BY 2022 PASSENGER TRAFFIC IN EMERGING ECONOMIES TO SURPASS ADVANCED ECONOMIES

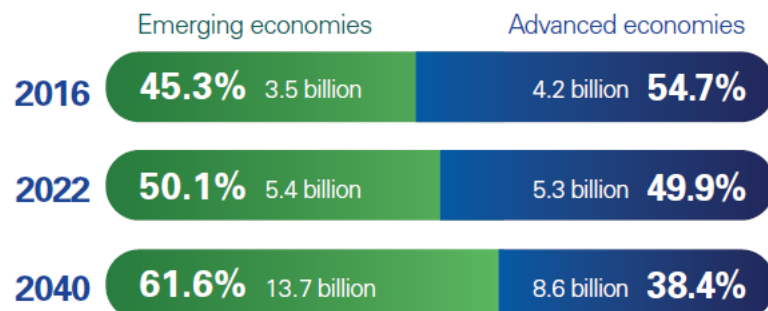



## WATF 2017

### Annual World Airport Traffic Forecasts 2017–2040



GLOBAL AVERAGE ANNUAL GROWTH RATE 2016–2040



CHANGING AVIATION MARKET SHARES OVER TIME



2016 → 2040



2016 → 2040



2016 → 2040



BY 2040 INTERNATIONAL PASSENGER TRAFFIC WILL APPROACH PARITY WITH DOMESTIC TRAFFIC



REGIONAL CONTRIBUTION TO INTERNATIONAL PASSENGER TRAFFIC GROWTH 2016–

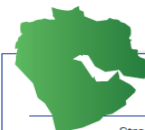
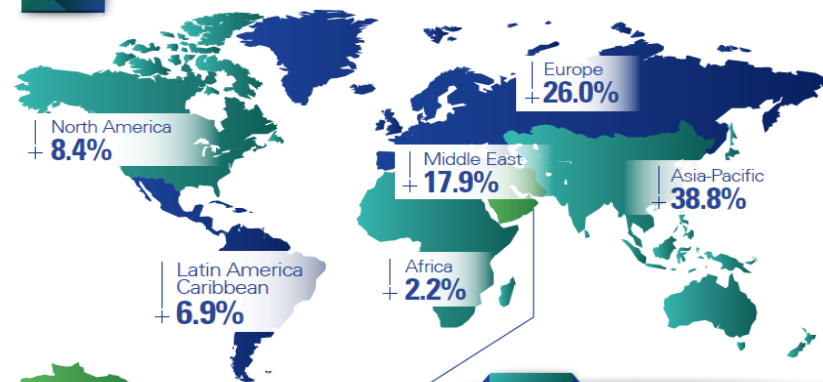

MIDDLE EAST: The "aviation bridge"

Strong growth of airport traffic and capacity in the Middle East due to strategic location and liberalized market has allowed the region to develop into an international hub, connecting long-haul flights from east and west, north and south.

TOP 10

FASTEST GROWING COUNTRY FOR PASSENGERS 2016–2041 (Over 50 million passengers per annum)

- Vietnam 8.4%
- India 7.5%
- Iran 7.3%
- Colombia 7.1%
- Saudi Arabia 6.9%
- United Arab Emirates 6.8%
- Indonesia 6.4%
- China 5.9%
- Malaysia 5.9%
- Philippines 5.7%



BY 2022 PASSENGER TRAFFIC IN EMERGING ECONOMIES TO SURPASS ADVANCED ECONOMIES

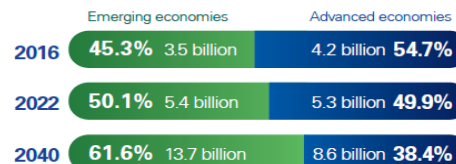

FIND OUT MORE AT [www.aci.aero/watf](http://www.aci.aero/watf)

All are emerging and developing economies



- Constant change

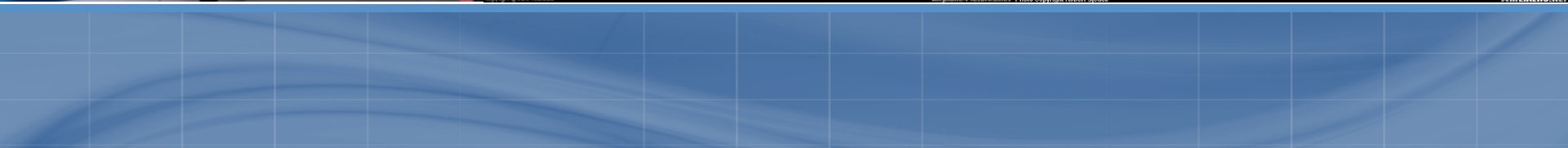



- Enable personnel and equipment to move safely and efficiently around aircraft during servicing between operations;
- Accommodate the safe, secure and orderly handling of passengers, baggage and cargo; and
- Provide sufficient lighting for night operations.

## •Passenger Terminal Apron



## •De-icing Apron



## •Apron Layout



## Apron Division Areas

- Aircraft Stand
- Apron Taxiway:
- Aircraft Stand Taxilane
- Apron Service Road
- GSE Staging Areas

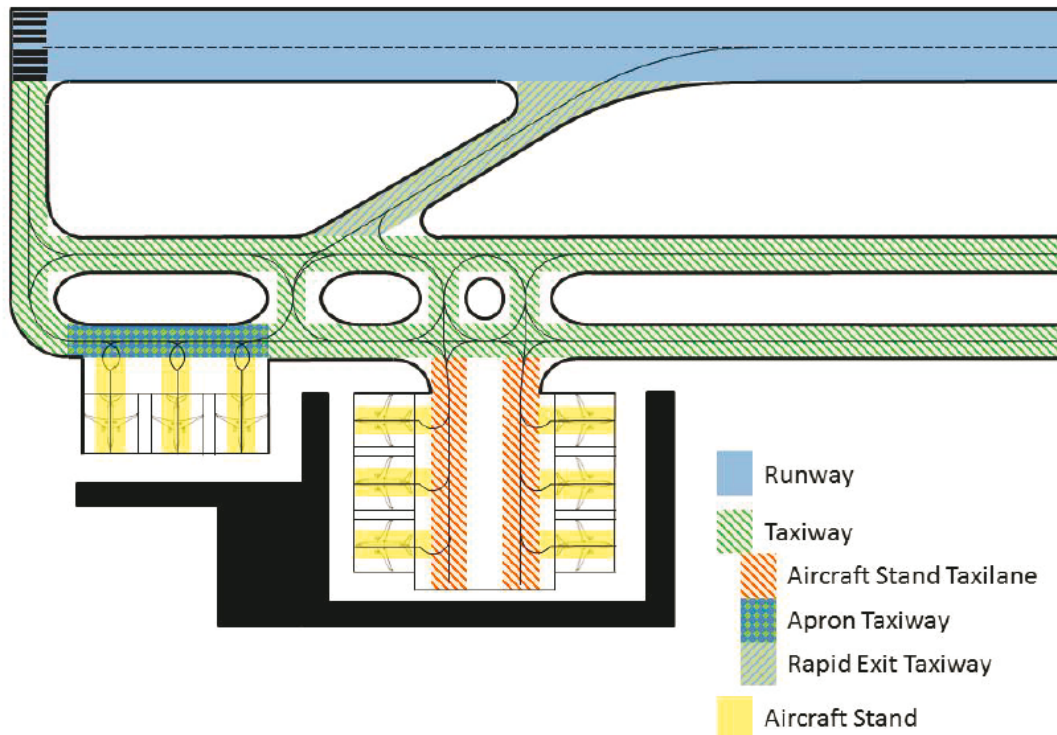

**Table 3-1. Taxiway minimum separation distances**

Code letter	Distance between taxiway centre line and runway centre line (metres)								Taxiway centre line to taxiway centre line (metres)	Taxiway, other than aircraft stand taxilane, centre line to object (metres)	Aircraft stand taxilane centre line to aircraft stand taxilane centre line (metres)	Aircraft stand taxilane centre line to object (metres)
	Instrument runways				Non-instrument runways							
	Code number	Code number	Code number	Code number	Code number	Code number	Code number	Code number				
(1)	(2)	(3)	(4)	(5)	(6)	(7)	(8)	(9)	(10)	(11)	(12)	(13)
A	82.5	82.5	—	—	37.5	47.5	—	—	23	15.5	19.5	12
B	87	87	—	—	42	52	—	—	32	20	28.5	16.5
C	—	—	168	—	—	—	93	—	44	26	40.5	22.5
D	—	—	176	176	—	—	101	101	63	37	59.5	33.5
E	—	—	—	182.5	—	—	—	107.5	76	43.5	72.5	40
F	—	—	—	190	—	—	—	115	91	51	87.5	47.5

Note 1.— The separation distances shown in columns (2) to (9) represent ordinary combinations of runways and taxiways. The basis for development of these distances is given in the Aerodrome Design Manual (Doc 9157), Part 2.

Note 2.— The distances in columns (2) to (9) do not guarantee sufficient clearance behind a holding aeroplane to permit the passing of another aeroplane on a parallel taxiway. See the Aerodrome Design Manual (Doc 9157), Part 2.

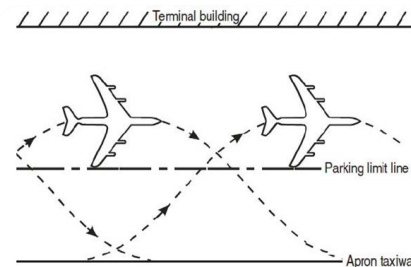

Figure 8 Taxi-in/taxi-out configuration (parallel parking) Ref. ICAO ADM Part 2, Figure 3-4

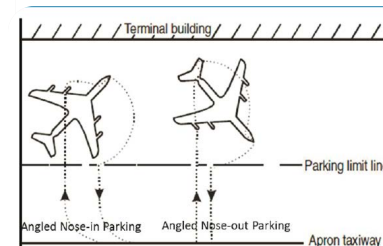

Figure 7 Taxi-in/taxi-out configuration (angled nose parking) Ref. ICAO ADM Part 2, Figure 3-4



Figure 9 Taxi-in/pushback configuration, Ref. ICAO ADM Part 2, Figure 3-4







Code letter      Clearance

- A      3 m
- B      3 m
- C      4.5 m
- D      7.5 m
- E      7.5 m
- F      7.5 m



- Self-maneuvring methods
- Taxi-in/Pushback Configurations

- Apron Markings Plan
  - Layout
  - Paint application
    - Paint type
  - Use of glass beads
  - Removal of markings
    - Water Blasting
    - Shot Blasting
    - Grinding
  - Inspections

The proposed colour coding of apron markings is therefore:

	<b>Yellow</b>	Indicates taxiway / taxilane centre line markings and aircraft stand markings intended for the safe manoeuvring of aircraft (ICAO). (See Note 1 below *)
	<b>White</b>	Indicates apron markings intended to regulate vehicle traffic and vehicle parking.
	<b>Red</b>	Indicates danger and borders where crossing is prohibited.
	<b>Blue</b>	Indicates subsidiary taxilane centre line, where alternative centre line routings are available (under ATC control). See note below.
	<b>Orange</b>	Indicates second subsidiary taxilane centre line, where alternative centre line routings are available (under ATC control). See note below.
	<b>Green</b>	Any other purposes as required locally.

To increase visibility of markings at night, in low visibility conditions, and where contrast between marking and pavement is insufficient, they should have a border in contrasting colour on both sides.

	<b>Black Border</b>	For yellow and white markings on light coloured pavements (e.g. concrete).
	<b>White Border</b>	For red markings on dark coloured pavement (e.g. bitumen).



## Different airport.- Different markings

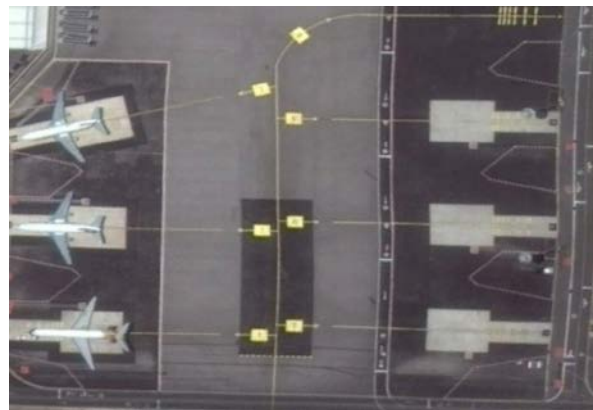

Same airport.- different markings



Is there an apron markings plan?

Is there a markings schedule?

## Stand safety line and equipment parking line

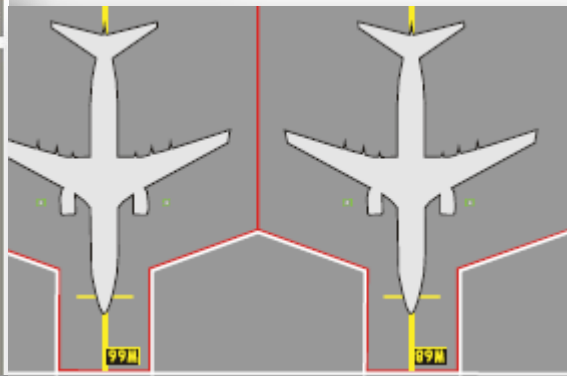
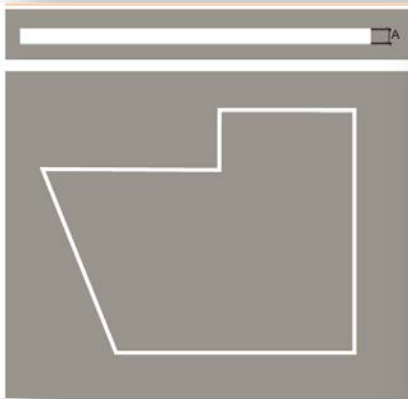
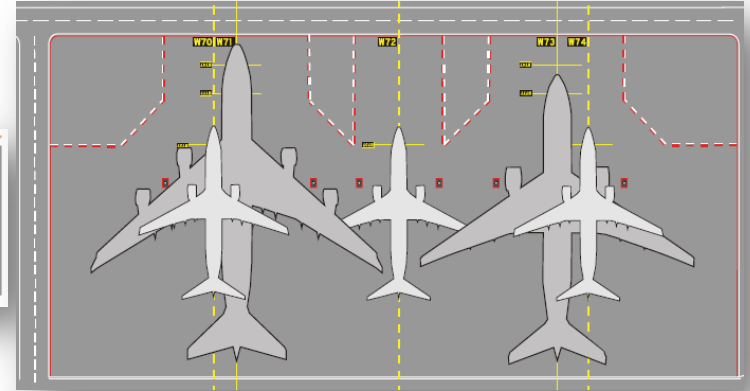
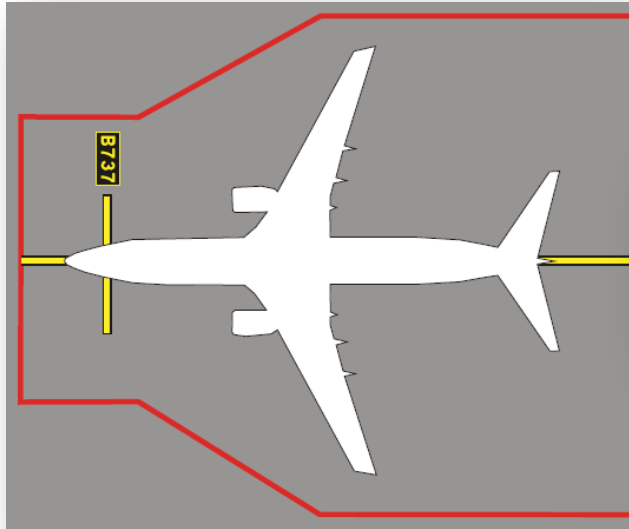

Vs





## No Parking Area

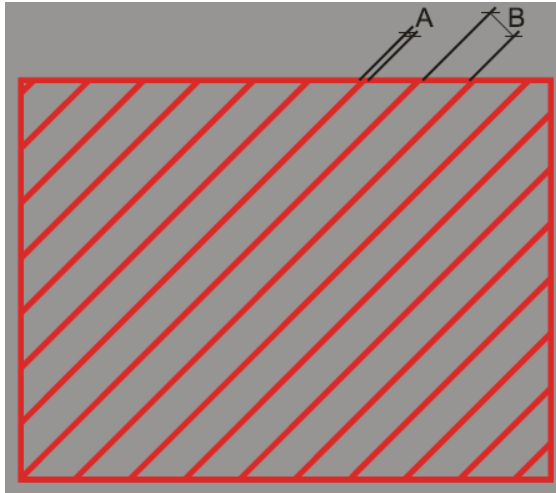

## Air Bridge Wheel Position

Dimensions	A	B
	0.1m min.	0.5 - 1.0m

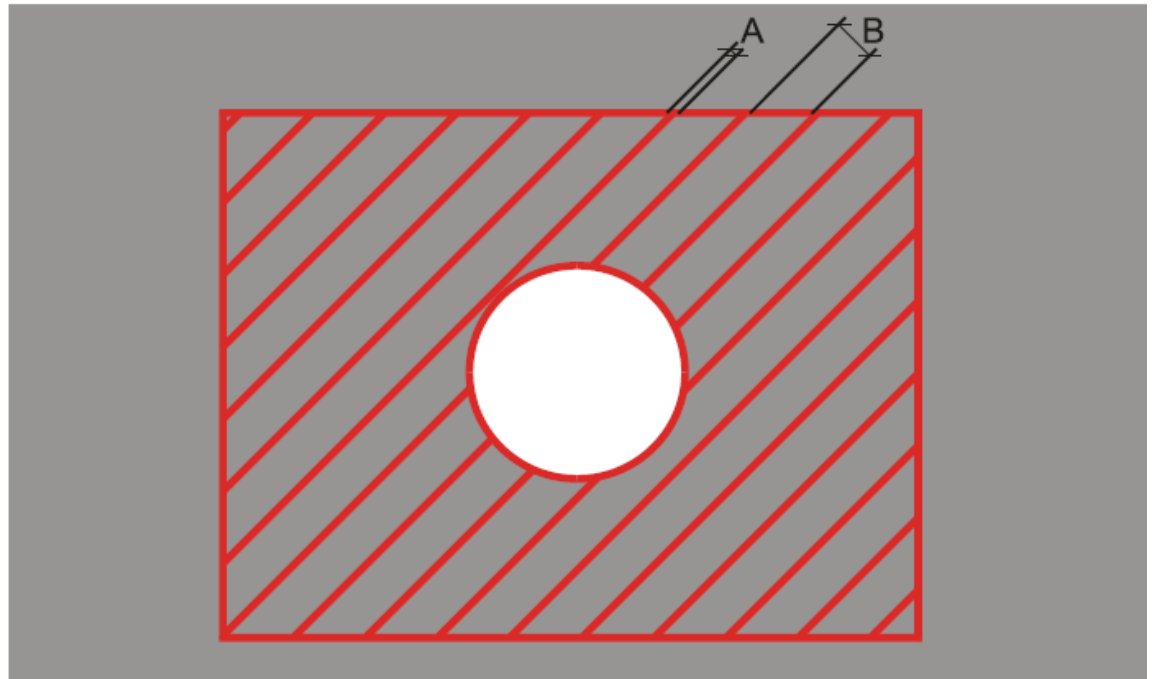



Multiple marshaller and towing stop line or T-Marks

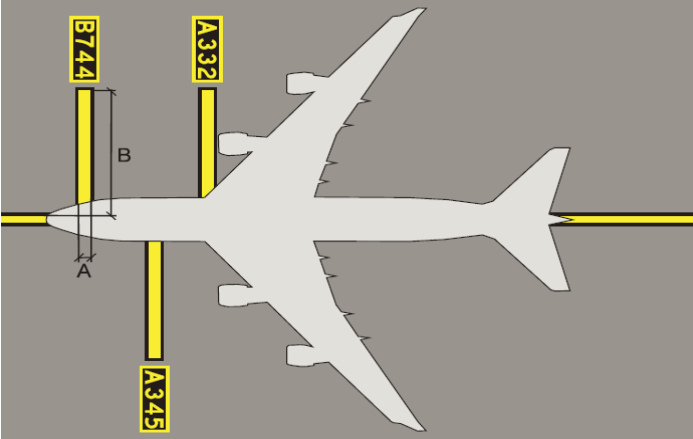

Or

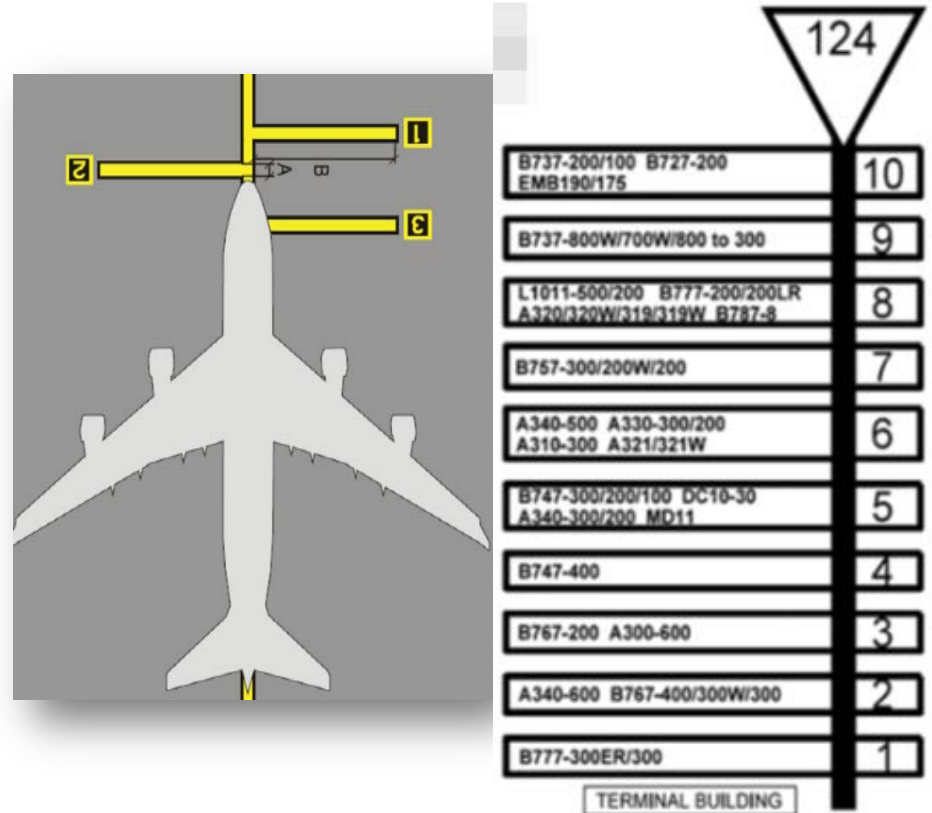

## Removal of markings



- Direction to stand markings

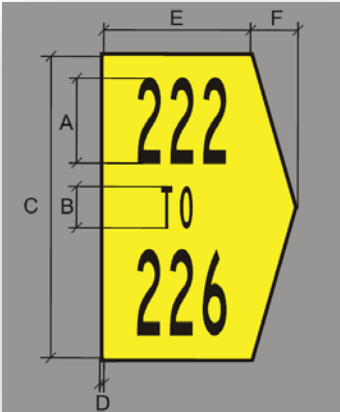

- Markings leading to construction site

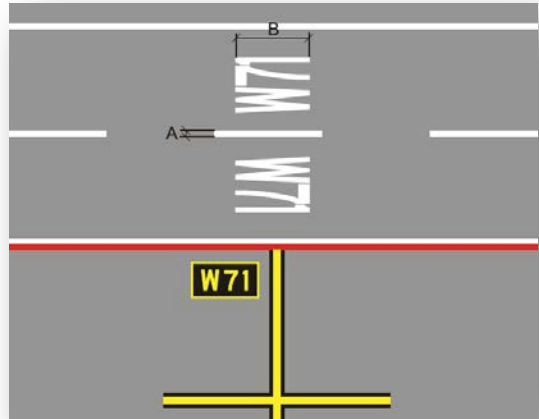

- Design issues

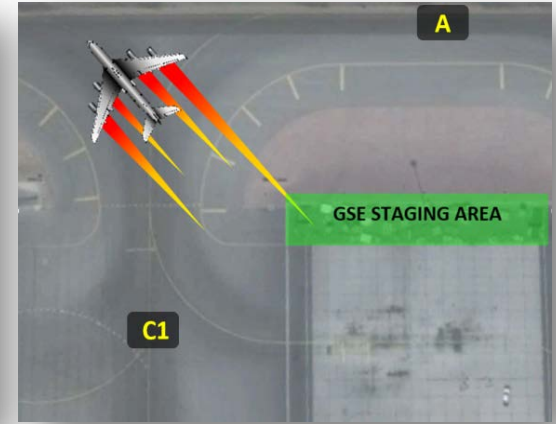

- Vehicle service roads



## Aircraft tail over vehicle service road

- Each lane of a service road should be of a minimum width able to accommodate the widest equipment in use at that location, e.g. emergency vehicles or ground-support equipment. It is important to mark roads on apron areas, to keep vehicle traffic clear of aircraft and taxiways, to minimize the risk of vehicle-to-vehicle accidents occurring.
- What is tolerable?

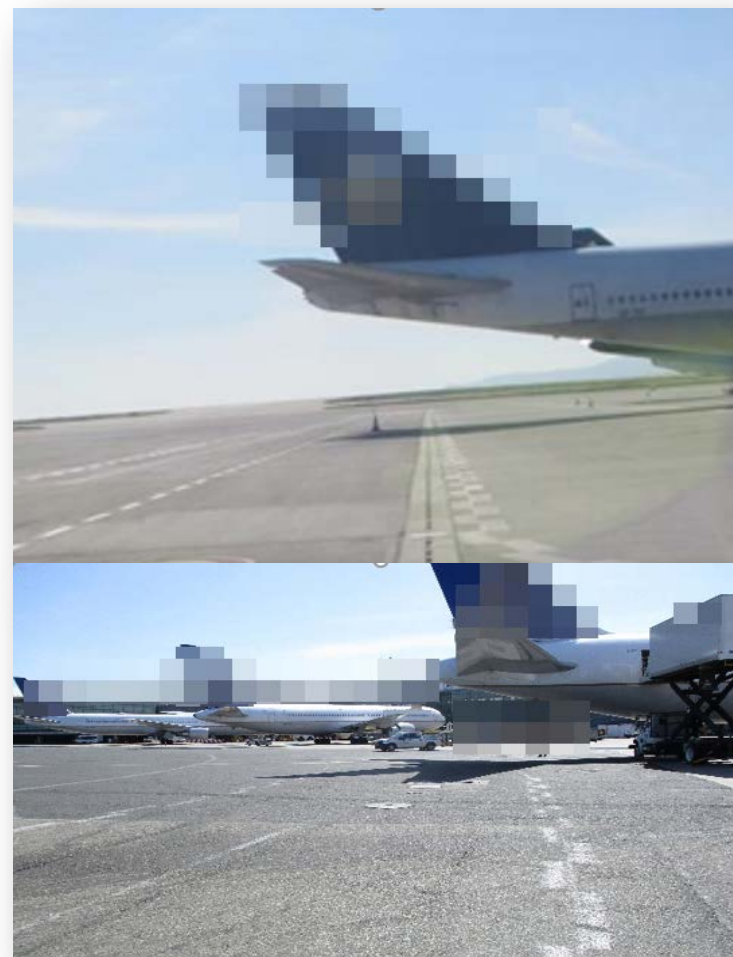
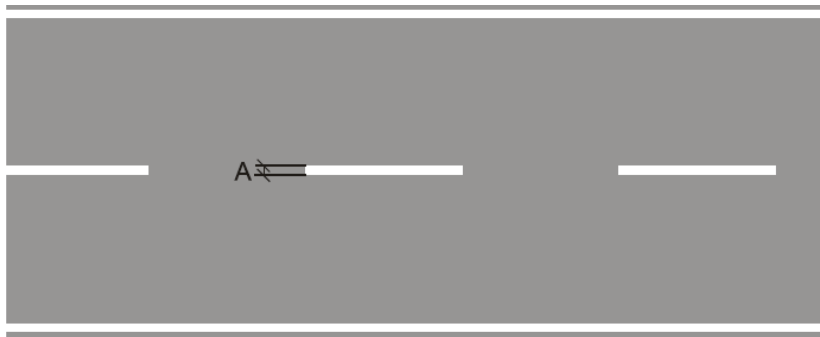

- General aviation



- Aircraft tie downs



- Lack of markings and signs



- Too many markings



- Controlled area? Pilot discretion? Ground Handler discretion?



What do you think?



- Speed Limits

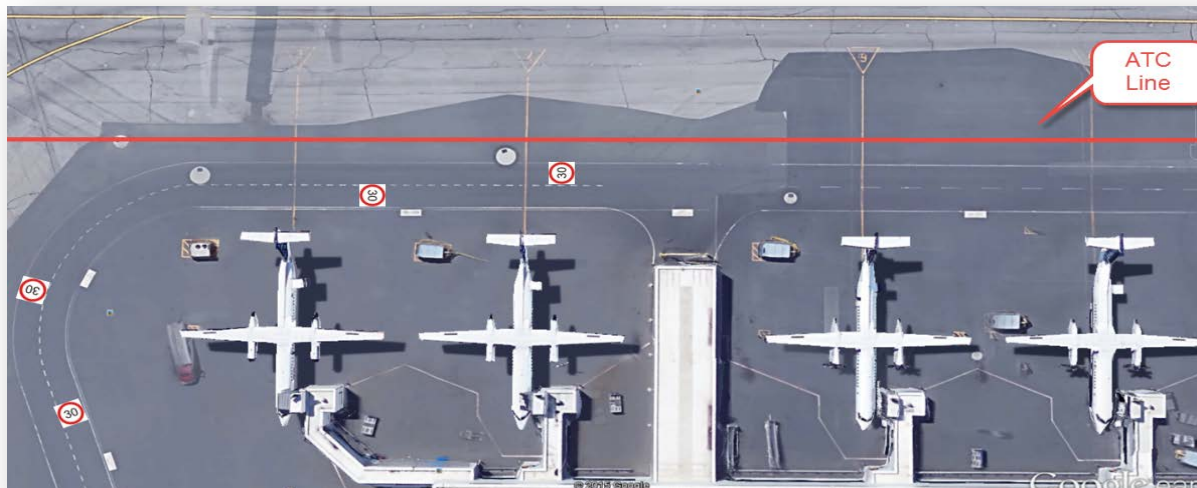

- Perimeter roads 50 km/h;
- Service roads 30 km/h;
- Tail-of-stand service roads behind aircraft 20 km/h;
- Stands 10 km/h;
- Reversing 5 km/h;
- Baggage sorting room 5 km/h

**QUESTION:**  
 What are your airport's  
 airside speed limits?  
 Do you know them?



Portable fire extinguishers are an important first line of defense against small fires. Standards have been developed by the US National Fire Protection Association (NFPA) for the usage and types of emergency equipment to be found on an airport

**Capacity, media type, location, maintenance and ownership of fire extinguishers should be clearly stated.**





# ACI Apron Markings and Signs Handbook

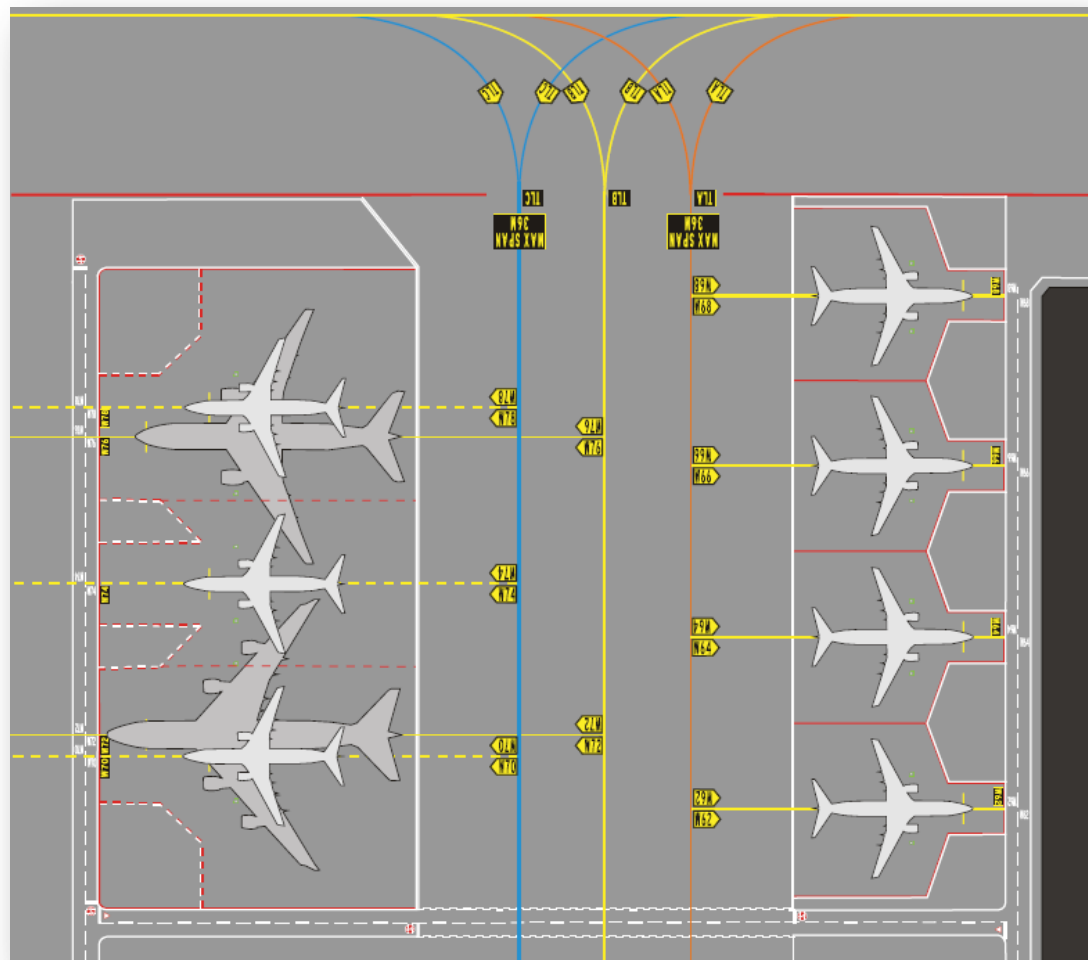



The  
**voice** of the  
world's  
**airports**

Leading, representing and serving the global airport community

*[www.aci.aero](http://www.aci.aero)*



[WWW.ACI.AERO/APEX](http://WWW.ACI.AERO/APEX)

THANK YOU!