



**FLIGHT DATA
MONITORING**
ON ATR AIRCRAFT
2016

INTRODUCTION

A Flight Data Monitoring Program assists an operator to identify, quantify, assess and address operational risks. It can be effectively used to support a range of airworthiness and operational safety tasks. Many customers share the same difficulties in adapting their processes, defining or fine-tuning the software from the supplier suitable for turbo-prop operations.

This handbook is written to accompany airlines in their implementation or fine tuning of their FDM process for their ATR fleet. It provides information and guidelines to promote, establish or enhance their FDM program. As any new publication, this handbook will be updated; hence we value your feedback and opinion both on the form and content.

What ATR calls a Flight Data Monitoring (FDM) is:

A proactive and non-punitive program for gathering and analyzing data recorded during routine flights to improve flight crew performance, operating procedures, flight training, air traffic control procedures, air navigation services or aircraft maintenance and design.

Depending on the context (generally geographically related), such program may have different name and acronym:

- F**light **D**ata **A**nalysis (Program): FDA or FDAP
- F**light **D**ata **M**onitoring program: FDMP
- F**light **O**perations **Q**uality **A**ssurance: FOQA

As illustrated here below, the document describe the FDM as the general process including the statistics follow-up and evolution of events (mapping of network difficulties, trends, safety indicators), whereas FDA (Flight Data Analysis) describes the detailed investigation of one event (Single occurrence investigation, detailed investigation, practical flight investigation).



The FDM process inherently belongs to the Safety Management System (SMS) of an airline. In most countries, the implementation of a SMS process is mandatory. FDM is currently not mandatory, at least under FAA and EASA regulations, for aircraft with a MTOW below 27 tons.

FDM is an efficient input to SMS for flight operations.

Important notice: This brochure is intended to provide general information regarding FDM. In no case it is intended to replace the operational and flight manuals for ATR aircraft. The procedures described in the AFM shall prevail over the information contained in this document.

FLIGHT DATA MONITORING ON ATR AIRCRAFT

CONTENTS

GLOSSARY	P. 4
1. DEFINITIONS.....	P. 5
2. GUIDANCE MATERIAL	P. 6
2.1. FDM	P. 6
2.1.1. ICAO.....	P. 6
2.1.2. EASA.....	P. 6
2.1.3. FAA	P. 6
2.1.4. UK CAA.....	P. 6
2.2. SMS.....	P. 7
2.2.1. ICAO.....	P. 7
2.2.2. EASA.....	P. 7
2.2.3. FAA.....	P. 7
2.2.4. UK CAA	P. 7
3. AIRLINE FDM PROCESS	P. 8
3.1. FDM IN SMS	P. 8
3.2. STAFFING / TRAINING RECOMMENDATIONS.....	P. 9
3.3. CONFIDENTIALITY	P. 9
3.4. NOMINAL AIRLINE WORKFLOW	P. 9
3.4.1 DATA RECOVERY	P. 10
3.4.2 DATA PROCESSING.....	P. 10
3.4.3 DATABASE FILTERING.....	P. 10
3.4.4 ANALYSIS.....	P. 10
3.4.5 STATISTICAL APPROACH	P. 11
3.5. FINE TUNING.....	P. 12
3.6. FDM ANALYSIS GOOD PRACTICES.....	P. 14

4. ATR SPECIFICITIES	P. 16
4.1. AIRCRAFT DATA RECORDER - GENERIC SCHEMATIC	P. 16
4.2. PRESENTATION OF ATR RECORDING CHAIN	P. 16
4.2.1 MPC FUNCTIONALITIES	P. 17
4.2.2. DATA RECORDING	P. 18
4.3. AVAILABLE PARAMETER ON EACH FRAME	P. 19
5. EVENT DEFINITION FOR ATR AIRCRAFT	P. 21
5.1. DEFINITION OF PARAMETERS USED	P. 21
5.2. COMPUTATION OF CHARACTERISTIC SPEEDS	P. 22
5.3. OTHER COMPUTED PARAMETERS	P. 25
5.4. ATR EVENTS	P. 25
5.4.1. DETECTION OF SPECIFIC FLIGHT EVENTS.....	P. 25
5.4.2. DEFINITION OF EVENTS	P. 27
6. ANNEXES.....	P. 32
6.1. REGULATION ON MANDATORY PARAMETERS TO BE RECORDED	P. 33
6.2. DATA FRAME PRINCIPLE	P. 33
6.2.1 RECORDING STRUCTURE	P. 34
6.2.2 SUPER FRAME ARCHITECTURE.....	P. 35
6.2.3 FRAME SAMPLING (OR FREQUENCY) DESCRIPTION.....	P. 37

FLIGHT DATA MONITORING ON ATR AIRCRAFT

GLOSSARY

ACMS: Aircraft Condition Monitoring System

AFDAU: Auxiliary Flight Data Acquisition Unit

APM: Aircraft Performance Monitoring

ASR: Aviation Safety Report

CRM: Crew Resource Management

CVR: Cockpit Voice Recorder

DFDR: Digital Flight Data Recorder

FDA: Flight Data Analysis

FDAU: Flight Data Acquisition Unit

FDEP: Flight Data Entry Panel

FDM: Flight Data Monitoring

FDR: Flight Data Recorder

FOQA: Flight Operational Quality Assurance

FSO: Flight Safety Officer

LOSA: Line Operation Safety Audit

MPC: Multi Purpose Computer

MRM: Maintenance Resource Management

PCM: Pulse Code Modulation

PLA: Power Lever Angle

QAR: Quick Access Recorder

SMS: Safety Management System

SSFDR: Solid State Flight Data Recorder

1. DEFINITIONS

Event: An occurrence or condition in which predetermined (values of) flight parameters are measured. Event detection is the traditional approach to FDM that looks for deviations from Aircraft Flight Manual limits, Standard Operating Procedures and good airmanship.

QAR (Quick Access Recorder): Copy of the FDR (Flight Data Recorder) on a non-crash resistant recorder which has the specificity to be easy to download.

Hazard: A condition that could foreseeably cause or contribute to an accident.

Risk: The combination of hazard likelihood and severity.

Reactive (Past): Response to events that have already happened.

Proactive (Present): Identification of hazardous conditions through the analysis of airline operations.

Predictive (Future): Analysis of systems processes and environment to identify potential/future problems.

FLIGHT DATA MONITORING ON ATR AIRCRAFT

2. GUIDANCE MATERIAL

The following lines provide useful references for further reading.

2.1. FDM

2.1.1. ICAO

Flight Data Analysis Program Manual / DOC 10000

2.1.2. EASA

- Paragraph ORO.AOC.130 of Commission Regulation (EU) 965/2012, Annexes III (Part ORO) contains the implementing rule requiring an FDM program for aeroplanes with a MTOW over 27 000 kg and operating for commercial air transport. That regulation is applicable in all EASA Member States since 29 October 2014.
- AMC1 ORO.AOC.130 of EASA Executive Director (ED) Decision 2012/017/R contains acceptable means of compliance for the implementation of paragraph ORO.AOC.130.

2.1.3. FAA

- Advisory Circular (AC) No 120-82: provides guidance on "developing, implementing, and operating a voluntary FOQA program - Good practice on the oversight of FDM programs (Version 1, Jan. 2015).

2.1.4. UK CAA

- **CAP 739 Flight Data Monitoring.** Document used by inspectors in the UK. This has subsequently been used as the basis for JAA and other advisory material.

2.2. SMS

2.2.1. ICAO

SAFETY RISK MANAGEMENT:

*“The objective of safety risk management is to **assess the risks** associated with **identified hazards** and **develop and implement effective and appropriate mitigations.**”*
(ICAO SMM /3rd version)

- ICAO defines the SMS standards in:
 - ICAO **Annexes 6:** Operation of Aircraft
Safety Management Manual (SMM) / Doc 9859
An efficient SMS will **manage the safety risks** associated with these contributors and will continuously **manage the performance** of the system.
 - ICAO **Annexes 19:** Safety Management

2.2.2. EASA

- EU-OPS Paragraph OPS 1.037 (Accident prevention and flight safety program)
- Article 2 EASA Basic Regulation EC N°216-2008

The EASA reference contains the elements of the ICAO State Safety Program.

The major principles of ICAO Annexes paragraph 3.2, such as data collection, monitoring of safety performance, evolution of data, providing data to personnel, anonymous reporting and proactive attitude towards the improvement of aviation safety, are included in EU-OPS 1.037.

Gap with ICAO Annexes 6: It does not explicitly require the definition of an acceptable level of safety and a continuous monitoring thereof by the operator which are key reactive rather than proactive aspects.

2.2.3. FAA

- Advisory Circular 120-82
- Flight Operational Quality Assurance program: A new subpart 1 was added to 14 CFR Part 13 which codifies enforcement protection for FOQA programs. This rule became effective November 30, 2001.

2.2.4. UK CAA

- CAP 795 Safety management systems (SMS) guidance for organizations.

FLIGHT DATA MONITORING ON ATR AIRCRAFT

3. AIRLINE FDM PROCESS

Flight Data Monitoring software collects and analyzes aircraft operational parameters that are recorded on board the aircraft typically using Quick Access Recorder (QAR).

QAR can typically record a large number of aircraft flight parameters. They are downloaded periodically when the aircraft reaches a suitable station or maintenance base. The resulting data is stored in a large data-base and analyzed to identify occurrences that exceed defined thresholds, and resulting trends.

Information about FDM software principles may be found in annexes 6.2.

3.1. FDM IN SMS

The principle of the SMS in an airline is to:

- Collect occurrence data;
- Identify hazards;
- Assess the risks (by combining the likelihood of occurrence and the possible consequences of each hazard);
- Identify and put mitigation measures in place;
- Monitor the efficiency of the mitigation.

FDM provides the capacity to analyze a wide range of parameters and to identify contributing factors that will help to assess and understand the root causes of in-service incidents - in complement to flight crew reports or interviews.

Since FDM gathers the data of the complete airline or fleet, the analysis provided in a weekly or monthly report enables one event to be analyzed in a general context instead of being focused on that single particular event.

The objective of setting up an FDM process in an airline is to transition from a purely reactive mode (incident analysis based on flight crew reporting) to a more proactive mode (early identification of undesired events and implementation of mitigation measures).

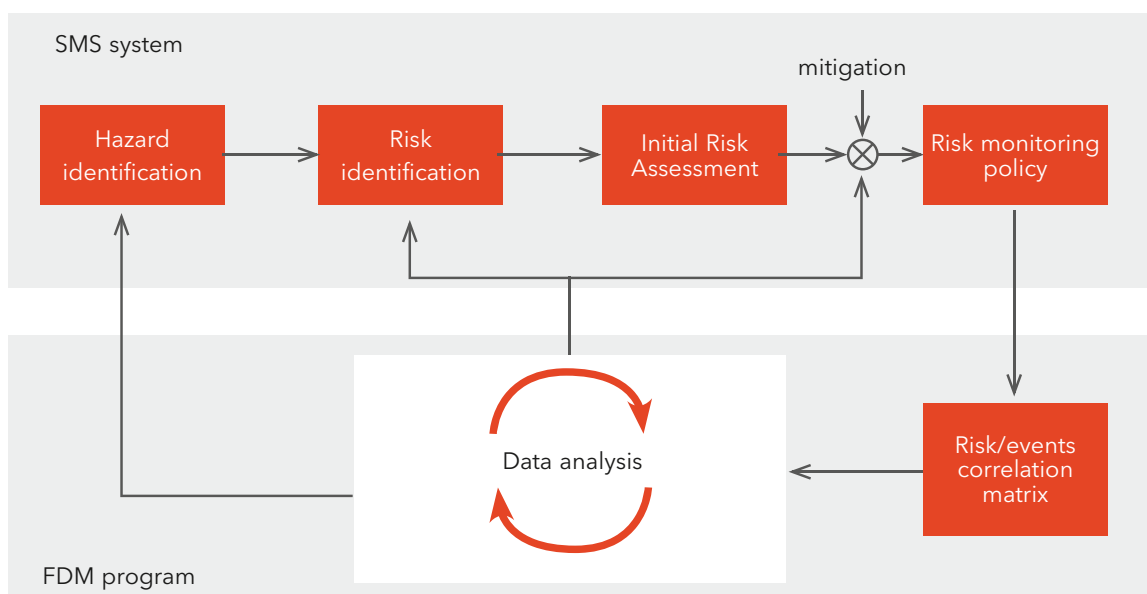

3.2. STAFFING / TRAINING RECOMMENDATIONS

To properly meet the workload of a typical airline with 10 to 20 aircraft, ATR recommends that the FDM team should at least consist of one FDM analyst and one type-rated pilot (or former pilot).

To perform relevant FDM and being credible to the operational community the team should have in-depth knowledge of operating manuals and aircraft performance characteristics - including SOPs, aerodromes and routes. The FDM team members must have appropriate training on the tools and software used.

To obtain complementary perspectives, 2 part-time people (one from the Safety department and one from the Engineering or Operational department) may provide a more synergistic approach than a single full-time analyst dedicated to the FDM program.

3.3. CONFIDENTIALITY

Defining safeguards ensuring confidentiality is paramount; FDM requires vigilant security and privacy protection for the data. Data shall be protected against unauthorized disclosure, alteration, misuse, or destruction. Data protection and security are sensitive issues that focus on the confidentiality of a particular air carrier, flight, date, or flight crew and recorded event.

The confidentiality policy has to balance the FDM team needs to access the data against the need to keep the data confidential. From the outset, air carrier policy and procedures for all security and protective aspects of the FDM program should be carefully designed, documented, implemented, and periodically reviewed.

Any disclosure for purposes other than promoting or improving safety of the flight operations can compromise the engagement of all persons involved, including flight crews or maintenance teams.

3.4. NOMINAL AIRLINE WORKFLOW

The FDM process key elements are:

- Identifying hazards or risk factors
- Determining the severity (probability of occurrence / level of consequences)
- Defining a mitigation plan, which can include:
 - dispatching good practices and standardization information to the flight crews
 - adapting SOP
 - adapting training
- Assessing the efficiency of these actions.

Different teams/functions will be involved: safety and flight operations at least, but engineering and/or maintenance may be included as well. The key tasks for which the FDM team will be the main actor are detailed below.

FLIGHT DATA MONITORING ON ATR AIRCRAFT

3.4.1 DATA RECOVERY

On ATR, the most convenient way to recover data is to get the MPC's PCMCIA card. Each time a card is recovered from an aircraft, it must be replaced by another one. In order to identify any corrupted PCMCIA card, it is strongly advised to dedicate each card to a specific aircraft. The number of cards required for each aircraft to ensure a smooth process may therefore vary and must be determined according to the airline's specificities. Based on the storage space available on the cards and the recording rate of the aircraft, the frequency with which data should be recovered is to be determined. If practicable ATR recommends a daily download. It is always preferred as it allows an early reaction if an incident is found in the data.

Wireless data transfer solutions for ATR already exist and others are under development.

3.4.2 DATA PROCESSING

Data is processed by software that provides a corresponding series of flights and flight events to the end user. Filtering those flights and events is necessary to ensure a good level of relevance and consistency in the database. Undesired events to be cleaned are generally recurrent and may be due to several factors such as improper thresholds or event definition under some circumstances (for instance in case of training flight or steep approach) or inaccurate terrain database (GPWS "undue" warnings). Even though such spurious events have to be cleaned to ensure a good quality of the database, their root cause needs to be identified and corrected when possible, either by configuring the software differently or contacting the manufacturer/vendor of the equipment at the origin of the issue.

The quality of the database can be assessed by the retrieval rate and the quality index.

- The retrieval rate is the ratio of the number of flights processed by the FDM software over the number of flights actually operated (coming from another source).
- The quality index is the ratio of the number of flights properly analyzed over the number of flights processed.

3.4.3 DATABASE FILTERING

Flight events need to be filtered. Deleting flight events under specific circumstances (for instance, long flare or late touchdown on a runway whose threshold was moved due to works ongoing as signified by a NOTAM) is a normal practice but should be temporary. Any permanent deletion policy on some events means that either the software tuning is not appropriate or that the event itself is not appropriate (which can result of a variety of reasons). In any case, investigation should be conducted to understand the cause of the issue and solve it.

3.4.4 ANALYSIS

Analysis is the heart of the FDM process. The simplest way to look at it is to monitor the occurrence rates and trends of the various events configured in the software. Typically, a high occurrence rate of one specific event should be investigated.

Analyzing a trend of occurrence rate over a large (> 6 months) period of time requires the knowledge of any change in the company that can impact this rate (change in SOP, change in routes or airports, change in FDM algorithm or thresholds, specific training given to the crews, etc.). The analysis consists in putting those numbers or occurrence rates in perspective.

To summarize, the FDM team provides the organization (but especially the SMS process downstream) the validated factual material on which the operational and safety strategy will be based or amended.

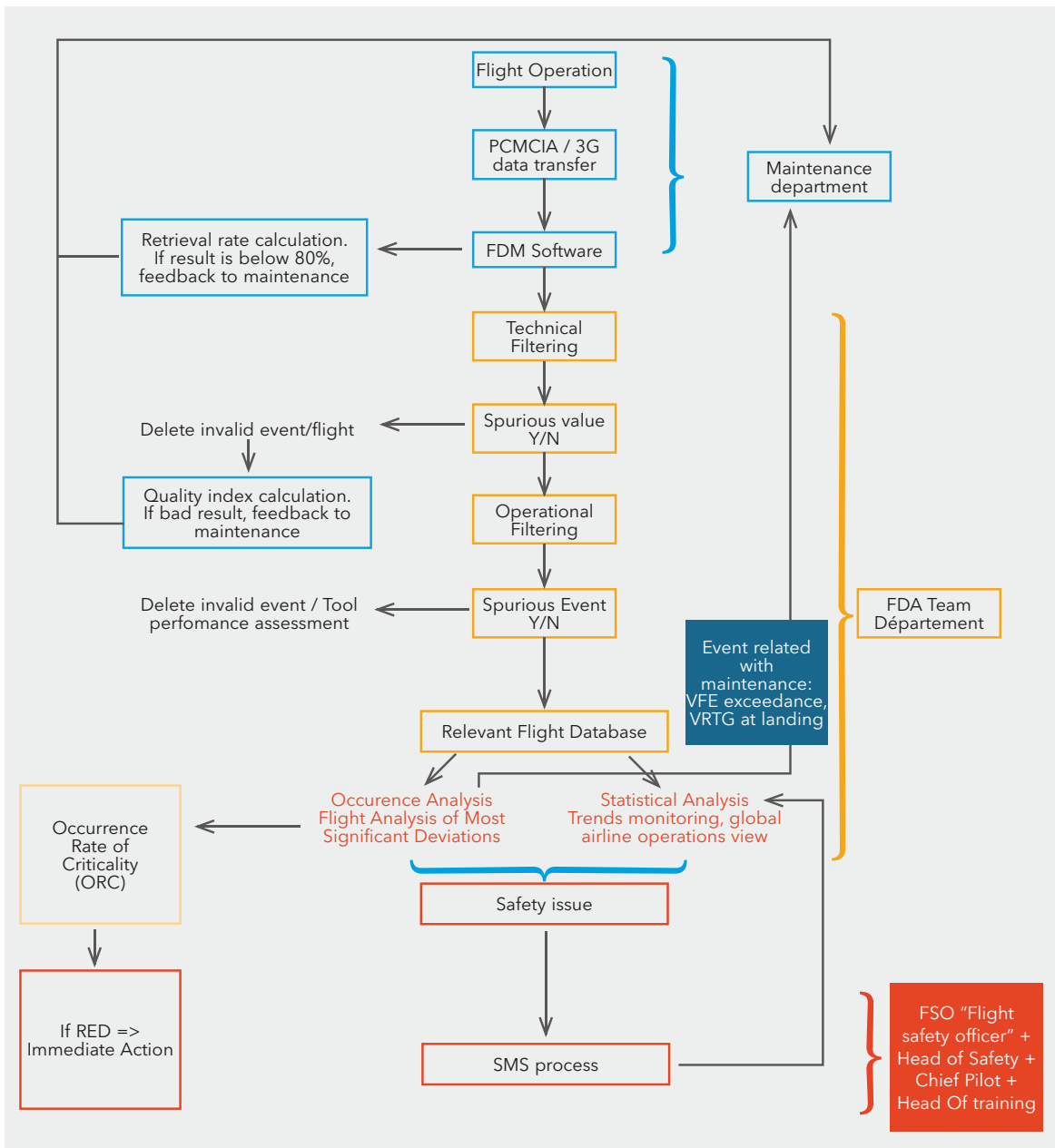

3.4.5 STATISTICAL APPROACH

The power of a FDM program is to provide data of a large quantity of flights over a significant period of time (generally, at least one year). A statistical approach to this data allows monitoring trends of occurrence of events and therefore identifying hazards or follows their evolution.

Practically, on a regular basis the FDM team would produce statistical reports with systematic data: top 10 events, top 10 red events, top 10 events at each airport, top events trends, etc... By producing those reports in a standard format it is then possible to monitor the evolution of the situation.

Any FDM software should provide a statistical module or capability.

FLIGHT DATA MONITORING ON ATR AIRCRAFT

It is important to remember that statistics are relevant only if they are based on a sufficient amount of data, especially when a breakdown of event rate per airfield or runway (for instance) is performed. In such case, a rate at a specific airfield may be artificially low or high just because there were not many flights to this airfield: no event on two flights would give an occurrence rate of 0% while one event would give a rate of 50%.

Generally speaking, extreme rates (low or high) should raise the attention of the analyst.

3.5. FINE TUNING

Fine tuning is the process with which the airline modifies the logics or the thresholds of one or several events. It is more likely to take place after several months and sufficient statistics reports. It can also be the consequence of a change in the SOPs that needs to be reflected in the FDM.

The company can tune these event thresholds to be more relevant by testing exceedance detection. This can be tested either by realistically manipulating normal data to simulate an event, by reducing the event limits such that normal flying will trigger events, or more acceptably, by replaying historical data known to contain incidents that should trigger events. It is also important to identify issues such as "false events" generated by the program.

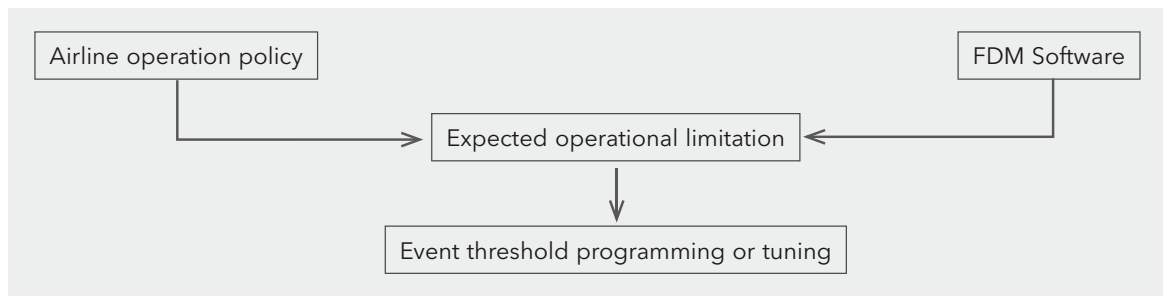

Example 1: High approach path on a specific airport due to obstacle constraints

Generally, the FDM software is using by default a 3° path angle standard to monitor the "path high or a path low in approach" deviation.

With, for example, the following values for the high approach path:

Severity 1 => 3.3°

Severity 2 => 3.5°

Severity 3 => 3.7° and above.

SEVERITY	SEVERITY 1 / LOW	SEVERITY 2 / MEDIUM	SEVERITY 3 / SEVERE
Above glide Slope standard threshold	3.3°	3.5°	3.7°

For a specific airport, this threshold can be changed by the company to be more representative.

If a path angle of 3.5° is required due to obstacle constraints:

Severity 1 can be adapted from 3.3° to 3.7°

Severity 2 can be adapted from 3.5° to 3.9°

Severity 3 can be adapted from 3.7° to 4.2° and above.

SEVERITY	SEVERITY 1 / LOW	SEVERITY 2 / MEDIUM	SEVERITY 3 / SEVERE
Above glide Slope modified threshold	3.7°	3.9°	4.2°

Without this event threshold tuning, a lot of events will be triggered without any relevant information. They will pollute the flight database and will not produce relevant statistics.

With the modified threshold, the event dispatch will show:

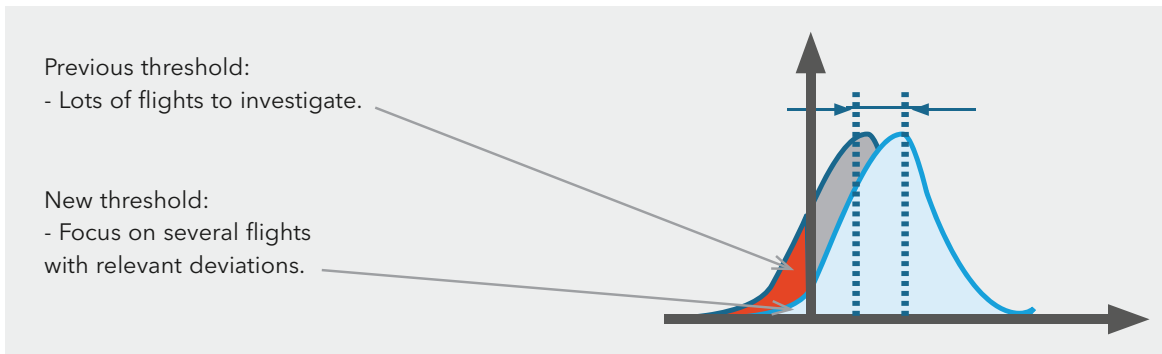

Example 2: High bank events in approach

Apart from tuning the thresholds, the company can tune the logic of a specific event to remove events that occur too often because of a specific and known feature. For example, while following a specific approach to a given airport, the crew has to perform a final turn at relatively low height. This may be the normal operational procedure at this location. In any case, because the “high bank in approach” is set up the same way everywhere, it would trigger far more often on this approach than anywhere else, and therefore pollute the database. As a consequence, the logics of the event may be adapted to take into account this specific approach and disable the event generation.

Be careful with event threshold modification; do not omit real events or real safety issues!

The tuning of a threshold must be done and reviewed with pilots, engineer and flight safety officer; and must be validated on the next occurrence/statistic report.

A threshold or logics shall not be changed to reduce the number of events but to reflect a specific type of operation or change in SOPs as agreed within the organization.

FLIGHT DATA MONITORING ON ATR AIRCRAFT

ROADMAP

IMPLEMENTATION PHASE PROPOSAL (1 YEAR)

Depends on company size and manpower

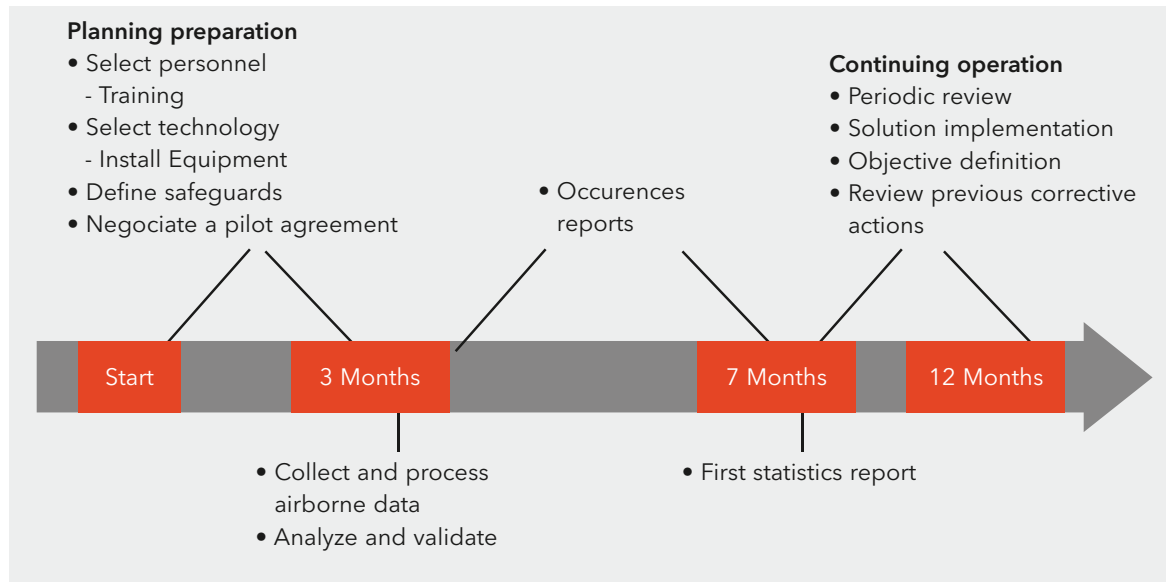

3.6. FDM ANALYSIS GOOD PRACTICES

Statistic results investigation method:

It is often helpful to explain features visually identified in the data by presenting basic sample statistics. These statistics can be used to describe the distribution of event and pattern of data over a range.

When looking at FDM or any other safety data it is important to take account of the chance of drawing the wrong conclusions by misreading random variations or by taking biased samples of data. There are inherent hazards in taking no action where a risk exists or taking inappropriate action where no risk actually existed. Statistical techniques have a range of practical applications in an FDM program such as detecting abnormalities, both in terms of user-defined limits and statistical significance versus randomness. This information can then feed the process of determining the actual severity of an event and, together with other relevant information, help identify actual potential risk. In turn this can lead to a better overall understanding of an event. When such techniques are employed in conjunction with IT systems and common software packages, it is practical to use these for day-to-day monitoring FDM on larger quantities of data. The identification of trends, clusters, exceptions and correlations between different variables will greatly assist the analyst's work.

Following tools are available in order to interpret statistics report:

- Times series chart can be used to identify:
 - Trend over time
 - Fluctuation over a fixed period
 - Extreme fluctuation
- Time series line
- Pie chart
- Box plot
- Histograms
 - Histograms may dispatch several events by severity; it is also used for the top 10 events (all severity) or top 10 red events (by airport, by flight phase...)
 - Histograms are also used for a concrete event like vertical G at landing to see the dispatch of the event value.

Consider the following tips when performing an analysis of the data:

- The scale of the graph and the axis choice. A percent or quantity (number of occurrences or number of flights) will not provide the same result.
- The sample (relevant sample is mandatory to study statistics), example: a single flight on a single destination with some major events will show this airport as "High risk airport" but in fact it is only one flight. In that case if a statistic like "Major airport with high % red event" is produced, this single flight will put this airport on the first place.
- Time period: it is important to take into account the date of any implementation solution, to monitor the effectiveness of this solution. To monitor positive or negative trend after an implementation date.

FLIGHT DATA MONITORING ON ATR AIRCRAFT

4. ATR SPECIFICITIES

Apart from the Flight Data Recorder (FDR) and Cockpit Voice Recorder (CVR) used in the case of accident/incident investigation, the modern aircraft are equipped with recorders and interfaces that enables the operator to record and retrieve flight data daily for on-ground analysis.

4.1. AIRCRAFT DATA RECORDER - GENERIC SCHEMATIC

The purpose of an airplane Flight Data Recorder (FDR) system is to collect and record data from a variety of airplane sensors onto a media designed to survive an accident.

To ease data recovery for the airlines' needs (such as performing FDM) Quick Access Recorder (QAR) systems have been developed. The QAR records a copy of the FDR data but on a media that is easily accessible and interchangeable.

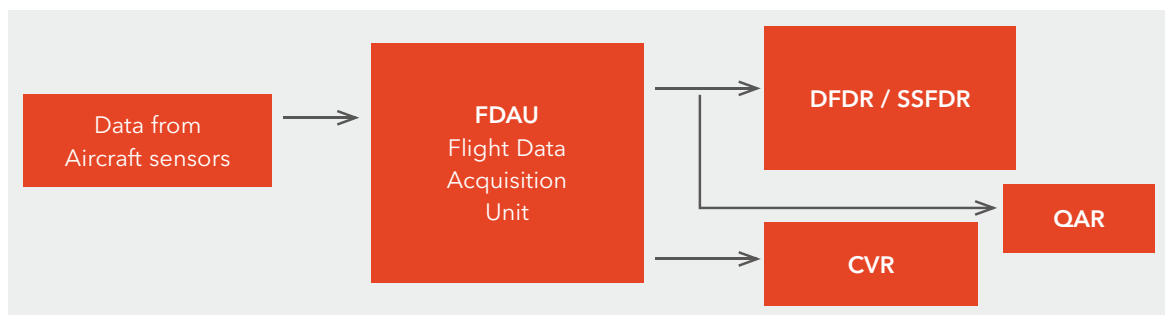

Each system or sensor from the aircraft sends data to the FDAU, which converts these signals into compressed data sent to the FDR. All these data are stored together with the recorded time in FDR. All parameters can then be read simultaneous with the time as axis base.

4.2. PRESENTATION OF ATR RECORDING CHAIN

ATR aircraft recording is ensured by two main systems:

- The Multi Purpose Computer (MPC), located in the avionic bay in the forward part of the aircraft, performing FDAU and QAR function
- The FDR, located in the tail of the aircraft. The most common type of FDR on ATR are SSFDR (Solid State Recorders) but some aircraft are still equipped with tape-based DFDR (Digital Flight Data Recorder)

As shown in the figure below, heart of the ATR recording chain is the MPC. Directly linked to aircraft systems and sensors, the MPC contains the FDAU function that converts and encodes data that will be transmitted to FDR and QAR.

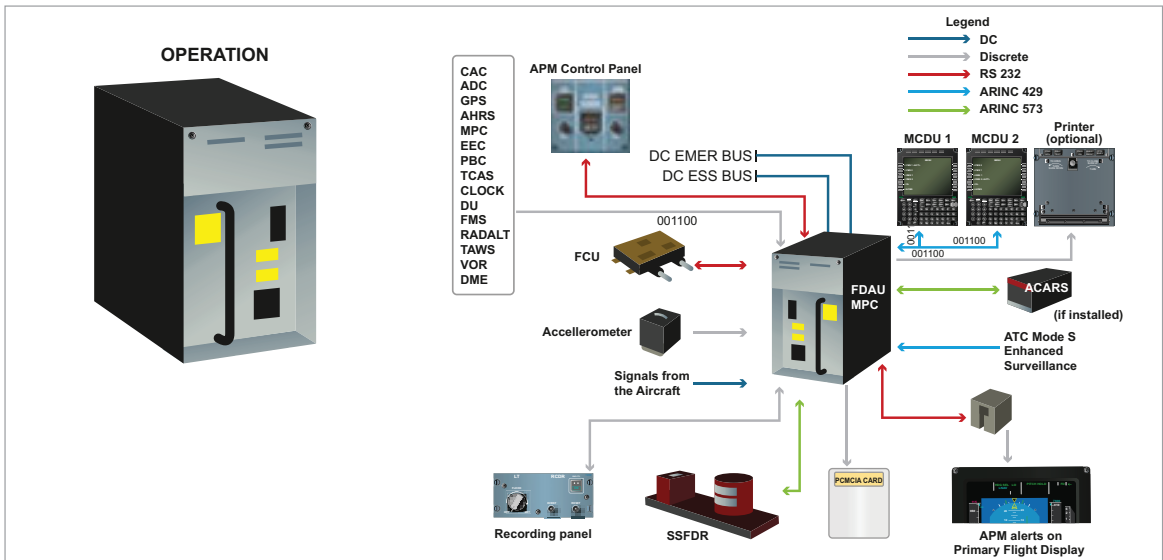

4.2.1 MPC FUNCTIONALITIES

Incorporated in the aircraft avionics suite, the MPC incorporates several different separate systems such as FDAU and Auxiliary FDAU (AFDAU).

It handles data collection and processing for both maintenance and regulatory purposes. The MPC features a centralized maintenance function.

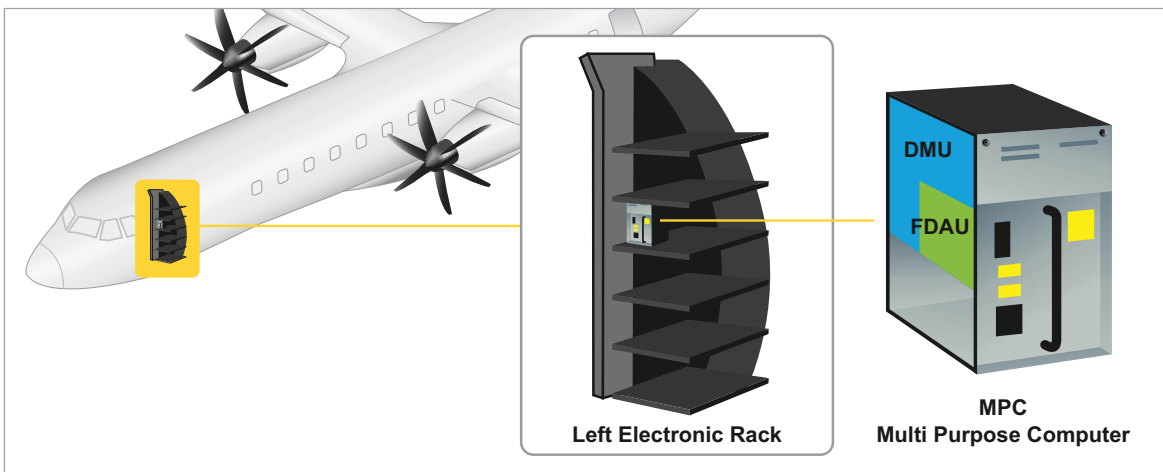

Located in the LH electronic racks, the MPC is composed of two independent applications:

- Flight Data Acquisition Unit (FDAU) software part,
- Data Management Unit (DMU) software part.

The FDAU software part acquires aircraft parameters in analogue, discrete and digital formats from aircraft systems. It concentrates all these data, in accordance with regulations (refer to annexes 6.1)

FLIGHT DATA MONITORING ON ATR AIRCRAFT

The main capabilities of the FDAU:

- Acquire aircraft parameters,
- Provides the Aircraft Performances Monitoring (APM) function,
- Parameters broadcast to avionics systems (CAC1 and CAC2),
- Recognition of aircraft configuration through pin-programming,
- Manage Time, Flight Time, Flight Number and Data loading,
- Synchronization between SSFDR and the CVR,
- Format and transmit data to FDR and QAR,
- Transmit data to the DMU

The DMU part of the MPC main functions:

- Format ACMS reports
- Aircraft Maintenance monitoring (ACMS) which facilitates the maintenance of the aircraft

4.2.2. DATA RECORDING

After acquisition, the parameters are processed and formatted into an ARINC 573 message for the SSFDR. The format of the message is a FRAME comprising four SUBFRAMES each having duration of one second.

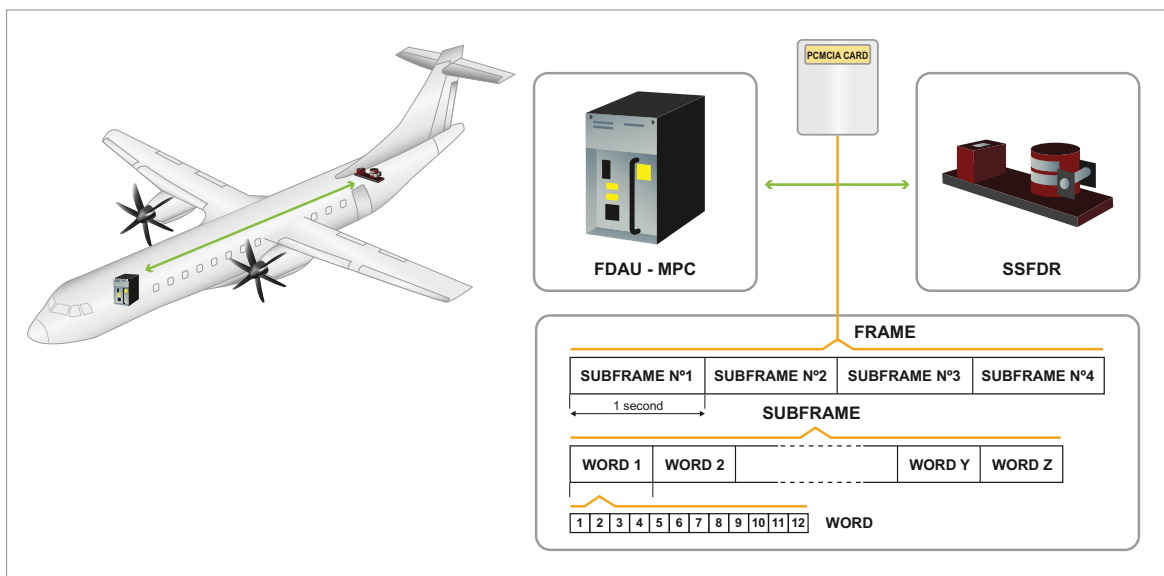

On ATR, each SUBFRAME comprises 64, 128, 256 or 1024 words of 12 bits. The same word can contain from 1 to 12 different parameters.

The characteristics of recorded parameters meets the requirements defined by regulations (refer to annexes 6.1) in terms of recording range, sampling rate, accuracy and resolution.

4.3. AVAILABLE PARAMETERS ON EACH FRAME

ATR FRAME VERSION

The data frame version installed in the Final Assembly Line is given in the table below. Retrofit solutions exist in order to improve the recording equipment embodied on an aircraft.

The first 2 rows show the correlation between frame version and the ARINC word capacity.
The third row shows the implementation of frame version regarding MSN (if possible)
The next rows are built on the same way e.g. ATR72

Frames descriptions are available in:

ATR-42 = Service letter ATR42-31-5011 (DFDR recorded parameters decoding law)

ATR-72 = Service letter ATR72-31-6010 (DFDR recorded parameters decoding law)

When setting up or running a program for new or existing aircraft, it is important to take the data frame capabilities of the aircraft fleet into account, in terms of parameters coverage and resolution. Either of these factors can influence the quality and options available for creating measures and events in the program.

NUMBER OF ARINC WORDS AVAILABLE / FRAME VERSION	64	64	64	128	256	1024
ATR 42	V0	V1	V2A	V2B	V3	V4
MSN	0 ⇒ 261	262 ⇒ 294	First 443 Standard from 513	First 443 Standard from 613	First 844 Not standard, option only	All 600 series
ATR 72	V0	V1	V2A	V2B	V3	V4
MSN	0 ⇒ 252	First 253	First 468 Standard from 494	First 572 Standard from 632	First 773 Not standard, option only	All 600 series
		V0 +GPWS +TCAS +A/P mode	V1+ +A/P mode sel +GNSS information +Flight Control pos +Icing AOA +Fuel Quantity +target Torque +Engine -torque	V2A+ +Fuel Flow +CCAS warning +Decision Height +Yaw trim position	V2B+ +Flight control forces +Brakes hydraulic pressure +Propeller beta	V3+ +Target speed +FWS +Precise weight +Procedures displayed +2 ADC information +DME Distance +AOA ½ +Distance to missed approach point +Drift angle +TA +VOR FREQ +VOR bearing

Correlation between dataframe version and MSN

FLIGHT DATA MONITORING ON ATR AIRCRAFT

Here are some examples of event monitoring creation improvements, following the evolution of the data frame capabilities:

Example in V1

- A/P Mode allows monitoring of a late A/P disconnection event.
 - Late A/P disconnection does not assure a safe landing. There is not enough time left to handle the aircraft properly.

Example in V2A

- DME distance allows monitoring a late descent point (procedure) (derive from GNSS). The result can be a path high in approach with high speed, high vertical speed, and late configuration setting.

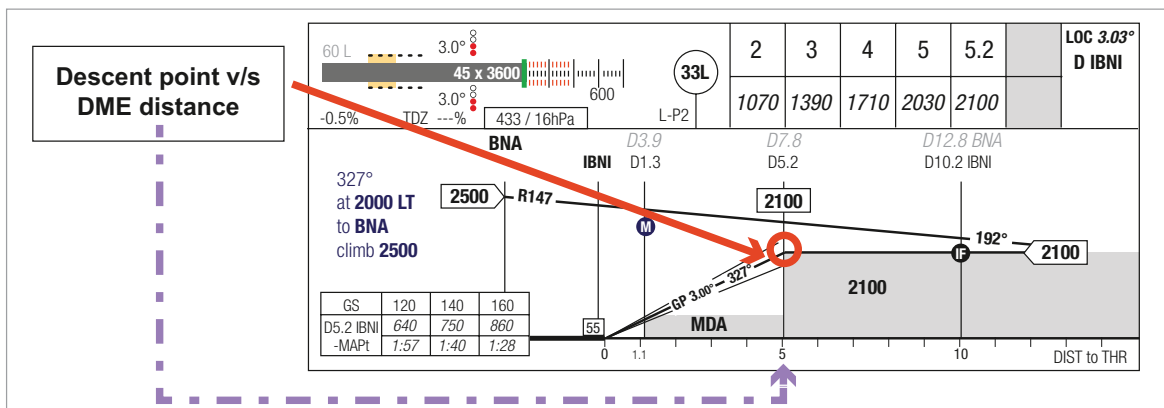

Example in V2B

- Fuel flow and flight time can be combined with TOW to compute weight during flight

Example in V3

- Control columns forces allow identifying dual or excessive control inputs.
- Propeller pitch

Example in V4

- Precise weight allows updating of all the events with more accurate values for each flight phase
 - Runway distance limitation event for takeoff and landing
 - Climb performance limitation event
 - Combining event with outside temperature can be used to change the threshold value for some parameters.

5. EVENT DEFINITION FOR ATR AIRCRAFT

5.1. DEFINITION OF PARAMETERS USED

The parameters required to monitor an event may be recorded in the FDR/QAR (or only in some FDR) or not. In the latter case, an alternative method is proposed to compute the parameter based on recorded parameters.

For instance, the following parameters are always recorded (from V0):

PARAMETER	ATR MNEMONIC	COMMENT
Altitude	ALT	The recorded altitude is the standard altitude, or pressure altitude: it is recorded with a barometric reference of 1013.25 hPA (29.92 inHg).
Pitch trim position	ELVT	The recorded pitch trim position corresponds to the deflection of the elevator tab, positive meaning tab up/pitch down. Hence, it is the opposite of the indication in the flight deck.
Flap position	FLAP	Depending on the dataframe, the left flap or the average position of both flap is recorded. On V4, both flaps position are recorded separately.
GPWS status	GPWS (or TAWS)	On all dataframes, there is at least a discrete parameter that trips when there is a GPWS warning. On V4, all warning modes are recorded (eg, "sink rate", "pull up", ...)
Ground speed	GS	The groundspeed is based on GPS/GNSS, therefore it is highly reliable but slightly delayed (1.5 second being the order of magnitude).
Indicated airspeed	IAS	
Lateral acceleration	LATG	
Longitudinal acceleration	LONG	Negative sign means the aircraft is accelerating.
Magnetic heading	MHDG	
Power lever angle 1 (2)	PLA1(2)	The PLA positions are given as seen by the HMU. In this reference, the reference Ground Idle (GI) position is 20°, Flight Idle (FI) position is 35° and the notch position (if applicable) is 75°.
Pitch attitude	PTCH	The pitch attitude reference comes from AHRS. On V4, the three sources of pitch information (both AHRS and EHSI) are recorded separately. It is recommended to use the Captain information by default.
Radio altitude	RALT	
Roll attitude	ROLL	See pitch attitude comment.
Selected altitude	SALT	
Landing gear selector (or lever) position	SLDG	
TCAS	TCAS	Available from V1 (except V2a), the TCAS resolution advisories are detailed (eg: "climb","descend",...)
Torque engine 1 (2)	TQ1(2)	
Vertical acceleration	VRTG	

FLIGHT DATA MONITORING ON ATR AIRCRAFT

5.2. COMPUTATION OF CHARACTERISTIC SPEEDS

Weight

Knowing the weight of the airplane is paramount: it is required for the computation of stall speeds (VS or VSR) and all associated characteristic speeds (VmLB, VmHB and then VAPP, etc.). On -600 airplanes, the gross weight (GW) is recorded from the crew input in the FMS with a good resolution. It is updated during the flight.

On legacy airplanes, the weight is automatically provided via the APM selected weight rotator position recording (SWEIGHT). It is meant to be set by the crew before take-off at the closest weight but has a limited precision (at worst +500 kg). It is still sufficient to compute the related operational speeds with a reasonable precision (a few kt). The parameter is available on all dataframes provided the installation of the APM which was mandated by AD (to be completed before Aug. 2015). It does not change during the flight, hence the weight must be updated either by using the Fuel Quantity parameter or by integrating the Fuel Flows.

Once the weight is known, a series of characteristic speeds can be computed that will in turn be used for the monitoring of events.

NOTE: The airspeeds in the AFM or the FCOM may be given in IAS or CAS. The relationship between IAS and CAS is given in the AFM, chapter 6.01.

VS, VSR, VS1G: Depending on aircraft certification basis, the stall speed is referred to as VS (for 42-3xx) or VSR. VSR is identical to VS1G and both may be used in ATR documentation depending on the variant but VSR will be referred to in this document. It is a function of flap / landing gear configuration and weight. The data can be found in the AFM 3.04-p2 or in the FCOM 2.01.03-p2. The example below is taken from the ATR 42-400/500 FCOM (basic version):

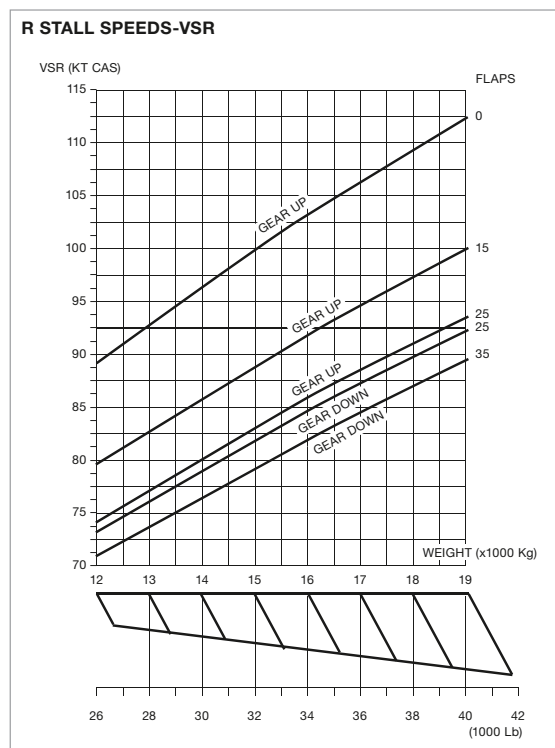

VAPP:

As defined in the FCOM (3.08.02):

$$VAPP = \text{MAX}(V_{mHB} + \text{Wind Factor}, VMCL)$$

where: Wind factor = MAX(1/3 of the head wind, gust factor, 15 kt)

It is generally not possible to know the gust factor based on flight data but a method based on ground and air speeds can be used in order to evaluate the head wind component. When ground speed is recorded, wind direction and speed usually are but with a lower sampling rate (every 4 s vs. every s). The recorded wind data can be used directly but the head wind component can also be deduced from ground speed (GS) and true airspeed (TAS, which is recorded in dataframes V4 or can be computed from IAS and ALT):

$$\text{Head Wind} = \text{TAS} - \text{GS}$$

Then the value obtained (for instance at 50 ft) is used to compute the wind factor.

IASth: The theoretical IAS in cruise depends on the temperature, flight level and weight. The data can be found in the QRH 4.3X / 4.4X or in the FCOM 3.05.02. The example below is an extract from ATR 72-212A FCOM:

20 T		CRUISE 2 ENGINES				
		MINIMUM TIME				
FLIGHT LEVEL	DELTA ISA					
	-10	0	+10	+15	+20	
60	94.4	94.5	88.1	83.1	78.6	
	466	471	450	433	416	
	252	250	241	235	229	
	267	270	265	261	256	
80	94.5	94.5	84.4	79.9	75.4	
	459	464	429	412	396	
	250	248	235	229	223	
	273	276	266	262	257	
100	94.5	90.4	81.0	76.5	72.3	
	453	441	409	392	377	
	247	241	229	222	216	
	278	275	267	262	257	
120	93.8	86.3	78.1	73.9	69.8	
	446	419	390	376	361	
	244	234	223	217	211	
	283	277	268	263	258	
140	89.5	83.0	75.7	71.7	67.7	
	428	401	374	361	347	
	237	228	217	211	205	
	283	278	270	265	260	
160	85.0	79.2	72.6	69.3	65.5	
	407	382	357	345	332	
	230	221	211	206	199	
	283	278	270	266	261	
180	79.7	74.6	68.7	65.5	62.3	
	383	361	337	325	314	
	221	213	203	198	192	
	281	276	269	264	259	
200	74.0	69.4	64.4	61.6	58.7	
	357	336	316	305	295	
	212	204	194	189	183	
	278	273	266	261	255	
220	68.4	64.3	60.0	57.5	54.9	
	331	313	294	285	276	
	202	194	185	179	172	
	274	268	261	256	249	
240	63.0	59.3	55.3	53.2	50.9	
	306	289	272	265	256	
	191	183	172	166	159	
	268	262	252	246	238	
250	60.4	56.7	52.9	50.9	48.7	
	294	277	261	254	246	
	186	176	165	158	149	
	265	257	246	238	227	

TO % NP-82%
 KG/H/ENG
 IAS
 TAS

The theoretical airspeed in cruise at max cruise regime is the third line of each box.

VMCA: VMCA depends on altitude and temperature. The data can be found in the FCOM 2.01.03-p4.

FLIGHT DATA MONITORING ON ATR AIRCRAFT

The table below gathers limitations and other characteristic speeds definitions that will be used in the events settings:

	ATR42				ATR 72		
	300/320	400	500	500 V600	200	210/212A	212A V600
VMO (IAS)	250 230 (mod 1739+1790)	250					
VFE (IAS)	Flap 15 160 170 (mod 1790/1739/3686/8030) Flap 30 145 150 (mod 1790) Flap 45 130	Flap 15 170 180 (mod 5948+4462) Flap 25 160 Flap 35 150			Flap 15 185 Flap 30 150		
VLE (IAS)	160 170 (mod 1790)	180			185		
VLO RET (IAS)	160						
VLO EXT (IAS)	160	170					
VRA (IAS)	180						
MAX TIRE SPEED (GS)	165						
VMCL (CAS)	Flap 15 89 (PW120) 91 (PW121) Flap 30 87 (PW120) 89 (PW121) Flap 45 85	Flap 15/25 94.5	Flap 15 98.5 Flap 25 96		Flap 15 94 (PW124) 100 (PW127) 98 (PW127F/127M) Flap 30 90 (PW124) 98 (PW127/127F/127M)		
VMHB NORMAL C (IAS)	1.3* VS	1.23* VSR					
VMLB NORMAL C (IAS)	Flap 0 max(V2 OR 1.25*VS) Flap 15 V2	Flap 0 1.20*VSR Flap 15 V2	Flap 0 1.22*VSR Flap 15 V2		Flap 0 1.18*VSR Flap 15 V2		
VMLB_{ICING} (IAS)	1.45*VS	1.45*VSR			1.43*VSR	1.4*VSR	
VGA NORMAL C (IAS)	max(VmHB _(landing config) +5 OR 1.1*VMCA)		max(VmHB ₁₅ OR 1.1*VMCA)		max(VmHB ₁₅ OR 1.1*VMCA)		
V2MIN (NORMAL CONDITION)	max(1.2VS, 1.1*VMCA)		max(1.13VSR, 1.1 VMCA)				

5.3. OTHER COMPUTED PARAMETERS

VZ: The vertical speed is recorded in the -600 airplanes (dataframe V4). On legacy airplanes, it can be computed from the standard altitude parameter (as the ADC does, typically). In this case it is recommended to smooth the altitude data (moving average or any other smoothing function) with a typical time span of 5 seconds before deriving it.

FPA: The flight path angle can be computed based on geometrical altitude and ground speed. The geometrical altitude itself can be derived from the standard altitude, barometric setting and temperature. Once derived with the same method than for vertical speed, it provides a ground reference based vertical speed. The arctangent of the latter divided by ground speed then gives the FPA.

5.4. ATR EVENTS

5.4.1. DETECTION OF SPECIFIC FLIGHT EVENTS

Aborted take-off

Several possibilities exist that can be used or combined to analyze an aborted take-off:

- a change in the sign of the longitudinal acceleration during the take-off phase
- a reduction on the PLA from the notch or above ($\geq 75^\circ$) to lower values (typically that would be Ground Idle which is 20°) during the take-off phase
- a decrease in ground speed during the take-off phase, which is more reliable than monitoring the airspeed but introduces some delay

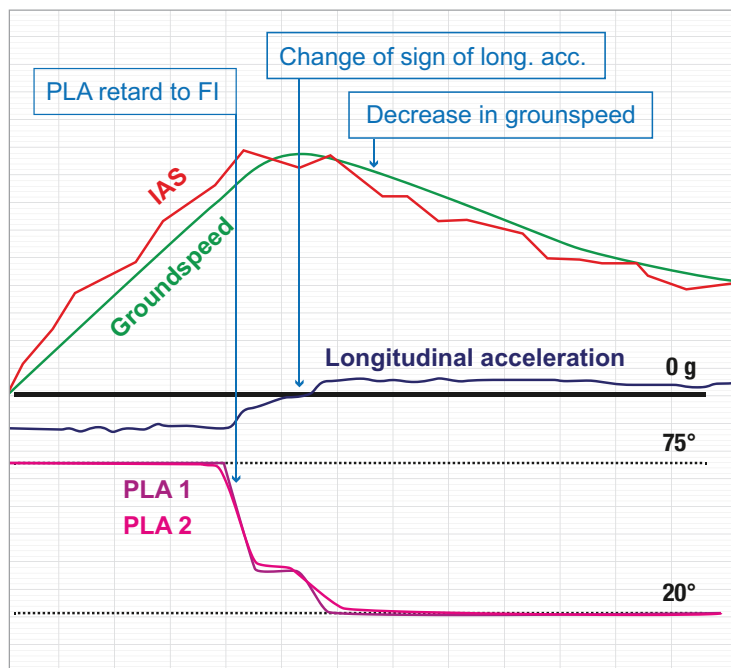

Typical aborted take-off parameters

FLIGHT DATA MONITORING ON ATR AIRCRAFT

Go-around

A go-around (GA) can be detected by:

- the engagement of the GA mode of the AFCS (associated with a disconnection of the AP)
- the increase of the PLA at or above the notch ($\geq 75^\circ$) during the approach or final approach phase
- the change in the sign of the vertical speed during the final approach phase

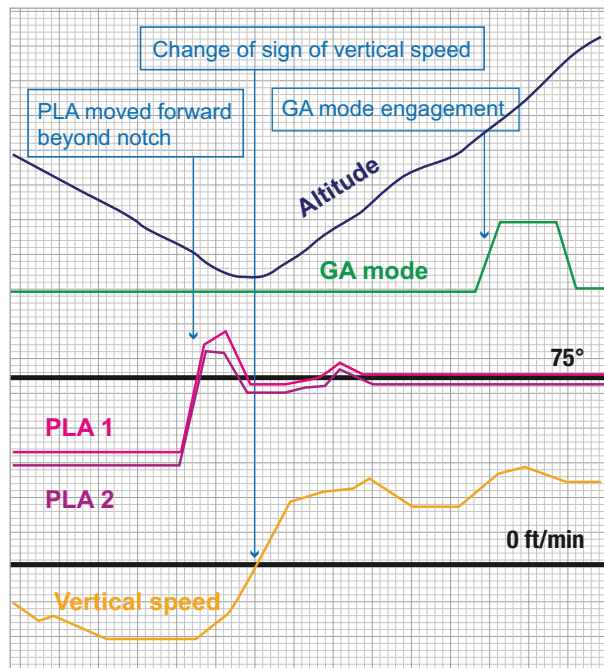

Typical go-around parameters

Touchdown

As illustrated in the chart below, the weight on wheel parameters are generally not very reliable, because they require at least both main landing gears to be compressed. Therefore there is often a change of state with a delay that can reach several seconds. It is a good indication of the latest moment at which the aircraft touched down, but the vertical acceleration and the radio height are generally more suitable to use to detect precisely the touchdown. At touchdown, the radio height is generally slightly negative.

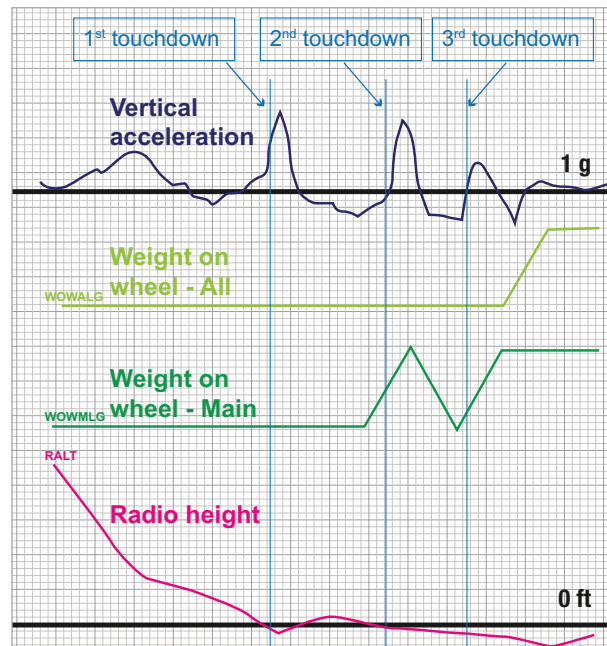

Typical landing parameters

5.4.2. DEFINITION OF EVENTS

The table below presents the list of proposed events to be monitored along with information needed to set up the event:

Monitoring window: defines the timeframe over which the event is monitored.

Criteria: defines the criteria that is tested to determine whether an event occurred or not. It uses DFDR or computed parameters (see above).

Thresholds/Confirmation give the values against which the criteria is tested for 3 levels of severity ("low" or class 3, "medium" or class 2 and "high" or class 1).

The events and events characteristics that are proposed have no mandatory value. The airline may customize its own events and/or thresholds based on its experience and specific operations. Typically, the events may be differentiated by airfield/runway (to cope with steep or step down approach, for instance) or thresholds standardised across the airline's whole fleet. At this stage, the events were chosen because they can be implemented with almost any version of dataframe.

FLIGHT DATA MONITORING ON ATR AIRCRAFT

EVENT	MONITORING WINDOW		THRESHOLDS / CONFIRMATION TIME			
	START	END	CRITERIA	LOW	MEDIUM	HIGH
TAXI						
High speed in straight line	Taxi phase		GS \geq	30 kt	40 kt	50 kt
High speed in turn			$ \Delta \text{MHDG} \geq 4^\circ/\text{s}$ AND GS \geq	15 kt	18 kt	21 kt
High TO			$\max(\text{TO1}, \text{TO2}) \geq$	10% / 15 s	15% / 15 s	20% / 15 s
TAKE-OFF						
Aborted TO at high speed	Aborted TO detected - 3 s	Aborted TO detected + 3 s	IAS \geq	100 kt	110 kt	120 kt
Change of heading during TO roll	Take-off phase		$ \Delta \text{MHDG} \geq$	3°/s	4°/s	5°/s
High lateral acceleration during TO roll	Take-off phase		$ \Delta \text{ATG} \geq$	0.15 g	0.25 g	0.35 g
INITIAL CLIMB / CLIMB						
Late LG retraction	Initial climb phase AND SLDG = UP		$\text{time}(\text{SLDG}=\text{UP}) - \text{time}(\text{VZ}>0) \geq$	10 s	15 s	20 s
Low VZ in initial climb	VZ > 0 AND RALT \geq 35 ft	VZ > 0 AND RALT \geq 400 ft	$\min(\text{VZ}) \leq$	750 ft/min	500 ft/min	250 ft/min
Low FPA in initial climb			$\min(\text{FPA}) \leq$	1.7°	1.4°	1.2°
Low IAS in initial climb			IAS \leq	V2min + 5 kt	V2min + 2 kt	V2min - 2 kt
High roll in initial climb			$ \text{ROLL} \geq$			16°
CRUISE						
Low IAS in cruise	Start of cruise phase + 1 min	End of cruise phase	ICING AOA = OFF AND IAS \leq	IASth-10 kt	IASth-20 kt	IASth-30 kt
Low IAS in cruise in icing conditions	Start of cruise phase + 1 min	End of cruise phase	ICING AOA = ON AND IAS \leq	VmLBO _{icing} + 20 kt	VmLBO _{icing} + 15 kt	VmLBO _{icing} + 10 kt
Level bust	Cruise phase		$ \text{SALT-ALT} \geq$	150 ft	200 ft	300 ft
DESCENT						
High ROD in descent	Descent phase		VZ \leq	-2500 ft/min	-3000 ft/min	-3500 ft/min
High speed in descent			IAS \geq	244 kt / 5 s	247 kt / 5 s	250 kt / 5 s

EVENT	MONITORING WINDOW		CRITERIA	THRESHOLDS / CONFIRMATION TIME		
	START	END		LOW	MEDIUM	HIGH
FINAL APPROACH						
Between 2000 and 1000 ft						
High ROD between 2000 and 1000 ft	Approach phase AND ALTOFE ≤ 2000 ft	Approach phase AND ALTOFE ≤ 1000 ft	VZ ≤	-1000 ft/min	-1250 ft/min	-1500 ft/min
High FPA between 2000 and 1000 ft			FPA ≤	-3.5°	-4°	-4.5°
High IAS between 2000 and 1000 ft			IAS ≥	VAPP+20 kt / 5 s	VAPP+25 kt / 5 s	VAPP+30 kt / 5 s
Low IAS between 2000 and 1000 ft			IAS ≤	VAPP-2 kt / 5 s	VAPP-5 kt / 5 s	VAPP-10 kt
Between 1000 and 500 ft						
High ROD between 1000 and 500 ft	Approach phase AND ALTOFE ≤ 1000 ft	Approach phase AND ALTOFE ≤ 500 ft	VZ ≤	-1000 ft/min	-1200 ft/min	-1400 ft/min
Low ROD between 1000 and 500 ft			VZ ≥	-400 ft/min	-250 ft/min	0 ft/min
High FPA between 1000 and 500 ft			FPA ≤	-3.5°	-4°	-4.5°
Low FPA between 1000 and 500 ft			FPA ≥	-2.5°	-2°	-1.5°
High IAS between 1000 and 500 ft			IAS ≥	VAPP+10 kt / 5 s	VAPP+15 kt / 5 s	VAPP+20 kt / 5 s
Low IAS between 1000 and 500 ft			IAS ≤	VAPP-2 kt / 5 s	VAPP-5 kt / 5 s	VAPP-10 kt
High roll between 1000 and 500 ft			ROLL ≥	10° / 3 s	15° / 3 s	20° / 3 s
Below 500 ft						
High ROD below 500 ft	Approach phase AND ALTOFE ≤ 500 ft	Approach phase end	VZ ≤	-1000 ft/min	-1200 ft/min	-1400 ft/min
Low ROD below 500 ft			VZ ≥	-400 ft/min	-250 ft/min	0 ft/min
High FPA below 500 ft			FPA ≤	-3.5°	-4°	-4.5°
Low FPA below 500 ft			FPA ≥	-2.5°	-2°	-1.5°
High IAS below 500 ft			IAS ≥	VAPP+5 kt / 5 s	VAPP+10 kt / 5 s	VAPP+15 kt / 5 s
Low IAS below 500 ft			IAS ≤	VAPP-2 kt / 5 s	VAPP-5 kt / 5 s	VAPP-10 kt
High roll below 500 ft			ROLL ≥	10°	15°	20°
Glide Slope Deviation	Final approach phase		GLS ≥	50 mV	100 mV	150 mV
Localizer Deviation	Final approach phase		LOC ≥	50 mV	100 mV	150 mV

FLIGHT DATA MONITORING ON ATR AIRCRAFT

EVENT	MONITORING WINDOW		THRESHOLDS / CONFIRMATION TIME			
	START	END	CRITERIA	LOW	MEDIUM	HIGH
GO-AROUND						
Low height during go-around	GA detected - 5 s	GA detected + 5 s	RALT	≥200 ft	<200 ft	-
Late LDG retraction	Go around phase SLDG = UP	AND	time(SLDG=UP)- time(VZ>0) ≥	10 s	15 s	20 s
LANDING						
High speed at touchdown	Touchdown - 2 s	Touchdown + 2 s	IAS ≥	VAPP	VmHB+15 kt	VmHB+20 kt
Low speed at TD	Touchdown - 2 s	Touchdown + 2 s	IAS ≤	VmHB-5 kt	VmHB-10 kt	VmHB-15 kt
Low Pitch at touchdown	Touchdown - 2 s	Touchdown + 1 s	PTCH ≤	0°	-0.5°	-1°
High Pitch at touchdown (ATR 42)	Touchdown - 2 s	Touchdown + 1 s	PTCH ≥	8°	9°	10°
High Pitch at touchdown (ATR 72)	Touchdown - 2 s	Touchdown + 1 s	PTCH ≥	6°	7°	8°
Reduced flap landing	Start of landing phase		FLAP ≤		22°	12°
Late PLA to GI	Landing phase AND PLA1+2 at GI		time since touchdown	4 s	7 s	10 s
Remaining power at touchdown	Touchdown - 1 s	Touchdown + 1 s	(TQ1+TQ2)/2 ≥	5%	10%	20%
Change of heading during landing	Landing phase		dMHDG ≥	3°/s	4°/s	5°/s
High LATG	Landing phase		LATG ≥	0.15 g	0.25 g	0.35 g
PLA below GI without low pitch	Landing phase		LOP1(2) not LOW PITCH and PLA1(2) ≤			15°
High acceleration at touchdown	Touchdown - 2 s	Touchdown + 10 s	VRTG	1.4 g	1.6 g	1.8 g

EVENT	MONITORING WINDOW		CRITERIA	THRESHOLDS / CONFIRMATION TIME		
	START	END		LOW	MEDIUM	HIGH
ALL FLIGHT						
GPWS / TAWS warning trigger	Initial climb phase start	Landing phase start	GPWS=			ON
Low speed			IAS ≤			1.05*VSR
High vertical acceleration in flight			VRTG-1 ≥	0.4 g	0.6 g	0.8 g
VFE, VLE, VLO, VMO			IAS ≥	limitation-5 kt / 3 s	limitation-2 kt / 3 s	limitation / 3 s
Excessive roll			ROLL ≥			40°

FLIGHT DATA MONITORING ON ATR AIRCRAFT

6. ANNEXES

CONTENTS

6.1. REGULATION ON MANDATORY PARAMETERS TO BE RECORDED	P. 33
6.2. DATA FRAME PRINCIPLE	P. 33
6.2.1 RECORDING STRUCTURE	P. 34
6.2.2 SUPER FRAME ARCHITECTURE	P. 35
6.2.3 FRAME SAMPLING (OR FREQUENCY) DESCRIPTION	P. 37

6.1. REGULATION ON MANDATORY PARAMETERS TO BE RECORDED

Regulations on parameters to be recorded only concern the DFDR. They also affect the QAR data since it is a copy of DFDR. These regulations are:

- ICAO - Annexes 6 Part I - Aeroplanes - Chapter 6 Para 6.3 - Appendix 8
- EASA - AIR OPERATIONS - Commercial Air Transport
AMC CAT.IDE.A.190 Flight Data Recorder
- EUROCAE - MOPS for Crash Protected Airborne Recorder Systems
ED-55 / ED-112 / ED-112 A
- FAA FAR 121.334 Digital Flight Data Recorders
Appendix M to Part 121 - Airplane Flight Recorder Specifications

6.2. DATA FRAME PRINCIPLE

Analogic parameters (torque, AOA ...) are converted to binary data

Binary data is composed of bits whose values are either 0 or 1.

FDAU aggregates binary data of different parameters in a specific order and sends the resulting data flow to the recorder. The sequence with which parameters are aggregated is defined by what is called a data frame. It is specific to the aircraft type and equipment (P/N of the FDAU, mainly).

A data frame describes all the parameters recorded, along with associated data allowing retrieving the binary, and then the original value: the position in the frame, the recording frequency, the resolution, the unit, etc.). Thanks to the dataframe definition, one can decode the binary data from the recorder.

FLIGHT DATA MONITORING ON ATR AIRCRAFT

6.2.1 RECORDING STRUCTURE

As illustrated by figure 5, the core element of the FDR recording is called a “word”. Each word is composed of 12 bits. This word can record the data of one or several parameters. Each parameter is identified by the word and the bit number on which it is coded. Words are grouped into sub-frames that represent one second of data. On ATR the subframes can be composed of 64, 128, 256 or 1024 words. Four sub-frames constitute a frame.

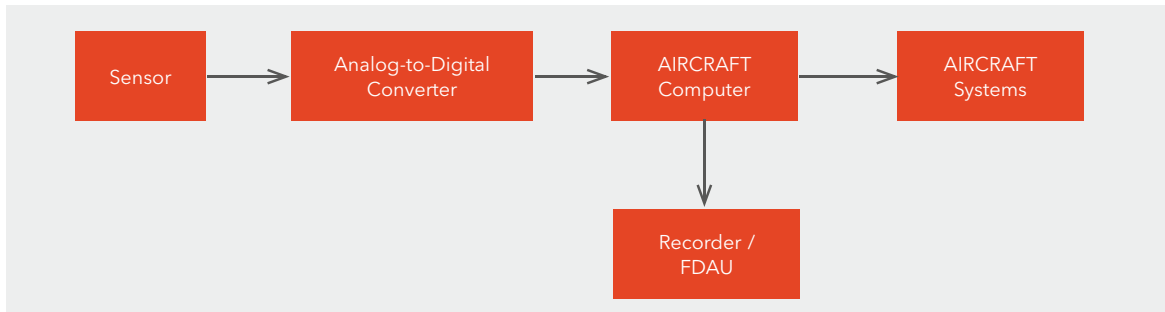

Recording principle

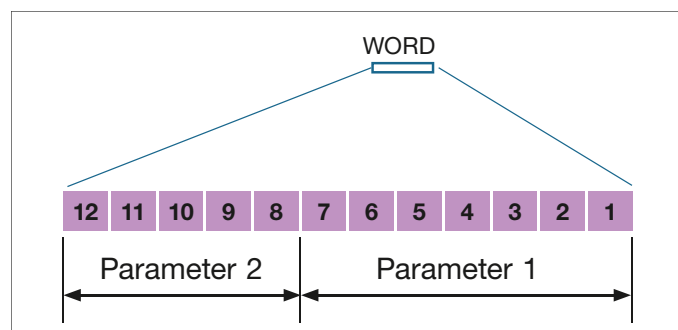
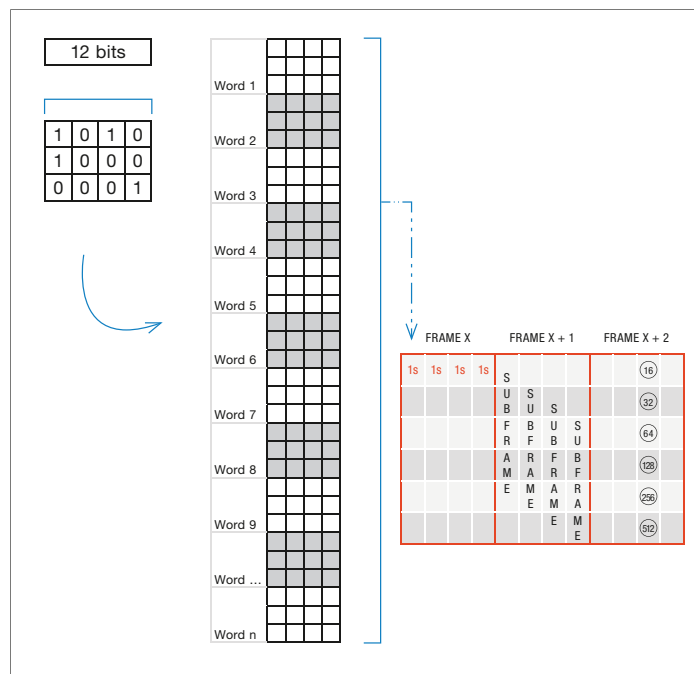

6.2.2 SUPER FRAME ARCHITECTURE

ATR FDR are using the principle of the superframe in order to save space and record parameters that not subject to rapid change (e.g. flight number, dates, hour, etc.). A superframe is a group of 16 frames (64 sub-frames).

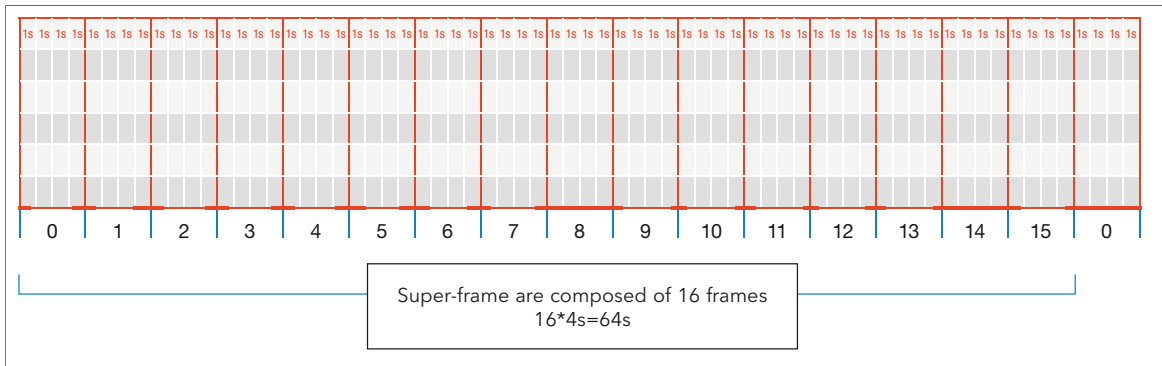

Superframe structure

The place of each frame within the superframe is defined by a parameter called “superframe counter” that ranges from 0 to 15.

To increase the number of parameters recorded in the same space, the idea is to share the same word of a given subframe between different parameters. Depending on the frame position within the superframe (value of the superframe counter), the parameter recorded on the word will be different.

Practical example:

On an aircraft embodied with a V2 dataframe version, SIL 72-31-6010 (table below) defines two superframe parameters locations (super frame 1 on word 50 of sub frame 1 and super frame 2 on word 57 of sub frame 1).

FDAU TYPE	SUPER FRAME 1	SUPER FRAME 2
V2	S/F1 & W50	S/F1 & W57
V2a, V2b	S/F1 & W57	S/F1 & W59
V3	S/F1 & W113	S/F1 & W117

Extract from the SIL 72-31-6010

In the definition of discrete parameters in the same SIL, the superframe counter is defined by the bits 9 to 12 of word 50 in subframe 1. The bits 1 to 8 of word 50 are therefore used to code the data for the superframe parameters that are defined: time, date, time in hotel mode, flight number, aircraft ident.

FLIGHT DATA MONITORING ON ATR AIRCRAFT

Discrete V2 parameters - D(V2)					
Parameter	ARINC word	Subframe	Sampling int. (persecond)	Bit	Law
time (hours) (superframe 1, position 10)	50	1	1/61 pps	8 to 5 4 to 1	convert reading in binary; tens in BCD on 1 bits convert reading in binary; units in BCD on 4 bits
time (minutes) (superframe 1, position 11)	50	1	1/64 pps	6 to 5 4 to 1	convert reading in binary; tens in BCD on 4 bits convert reading in binary; units in BCD on 4 bits
time (minutes/second)	50	3	1/4 pps	12 to 9 8 to 5 4 to 1	convert reading in binary; minute units in BCD on 4 bits convert reading in binary; second tens in BCD on 4 bits convert reading in binary; second units in BCD on 4 bits
date (day) (superframe 1, position 4)	50	1	1/64 pps	8 to 5 4 to 1	convert reading in binary; tens in BCD on 4 bits convert reading in binary; units in BCD on 4 bits
date (month) (superframe 1, position 3)	50	1	1/64 pps	8 to 5 4 to 1	convert reading in binary; tens in BCD on 4 bits convert reading in binary; units in BCD on 4 bits
date (year) (superframe 1, position 5)	50	1	1/64 pps	8 to 5 4 to 1	convert reading in binary; tens in BCD on 4 bits convert reading in binary; units in BCD on 4 bits
Time in hotel mode (minute) (superframe 1, position 9)	50	1	1/64 pps	8 to 5 4 to 1	convert reading in binary; tens in BCD on 4 bits convert reading in binary; hundreds in BCD on 4 bits
Time in hotel mode (minute) (superframe 1, position 8)	50	1	1/64 pps	8 to 5 4 to 1	convert reading in binary; tens in BCD on 4 bits convert reading in binary; units in BCD on 4 bits
Flight number (superframe 1, position 1)	50	1	1/64 pps	8 to 5 4 to 1	convert reading in binary; thousands in BCD on 4 bits convert reading in binary; hundreds in BCD on 4 bits
Flight number (superframe 1, position 2)	50	1	1/64 pps	8 to 5 4 to 1	convert reading in binary; tens in BCD on 4 bits convert reading in binary; units in BCD on 4 bits
Superframe 1 & 2 counter (superframe 1)	50	1	1/64 pps	12 to 9	0 to 15 in binary code
A/C ident (airline rank) (superframe 1, position 8)	50	1	1/64 pps	8 to 1	0 to 255 in binary code

V2 word 50 description

For instance, if the superframe counter is equal to 10, the values of the bits will represent the hours of the current time.

Figure below sums up the different values associated to the word 50 of the subframe 1:

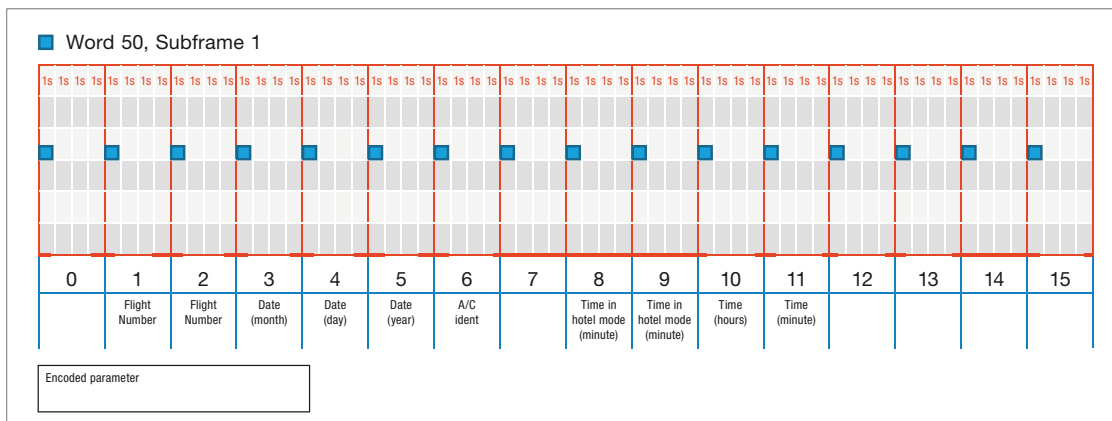

6.2.3 FRAME SAMPLING (OR FREQUENCY) DESCRIPTION

Sampling is the process of measuring a signal at specific points in time. The sampling rate or frequency is expressed in Hertz or in point per second (pps).

1HZ = (1 pps) => a parameter value is recorded once a second.

2HZ = (2 pps) => a parameter value is recorded twice a second.

4HZ = (4 pps) => a parameter value is recorded 4 times a second.

1/4 HZ = 1 point recorded every 4 seconds

1/2 HZ = 1 point recorded every 2 seconds

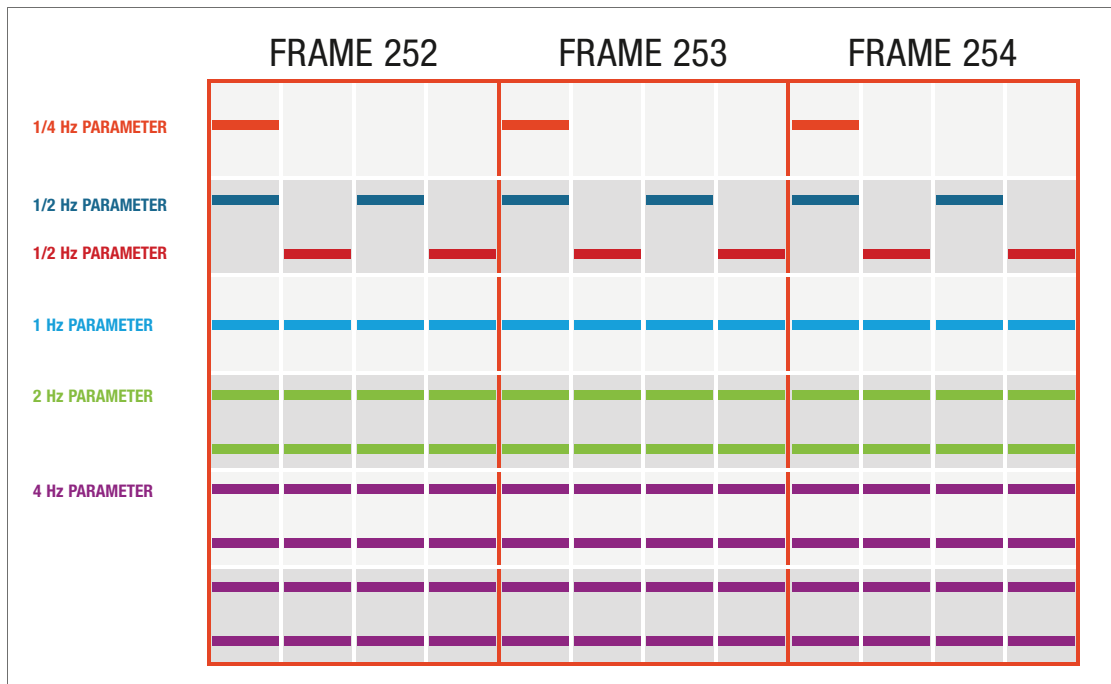

In that extract from SIL ATR42-31-5011, 4 concrete parameters (Weight Rotactor Position 1.2.3.4) are recorded at 1/4 HZ. Depending on the value of these 4 parameters in binary a hexadecimal value can be decoded.

4 parameters are necessary to give a concrete hexadecimal value. (From 15T to 22.5T)

WEIGHT ROTACTOR POSITION#1 *	38	1	1/4pps	2	0000: 15T
WEIGHT ROTACTOR POSITION#2 *	38	2	1/4pps	2	0001: 16T
WEIGHT ROTACTOR POSITION#3 *	38	3	1/4pps	2	0010: 17T
WEIGHT ROTACTOR POSITION#4 *	38	4	1/4pps	2	0011: 18T
					0100: 19T
					0101: 19,5T
					0110: 20T
					0111: 20,5T
					1000: 21T
					1001: 21,5T
					1010: 22T

FLIGHT DATA MONITORING ON ATR AIRCRAFT

Other example with different recording rate

VHF 1 (2)	14 (14)	1;2;3;4	1pps	1 (2)	0: transmission				
L/G Selector	448-960	1 to 4	2pps	1	0 = Up 1 = Down				
vertical acceleration (g)	3;35;67 99;131;163 195;227	1;2 3;4	8pps	12	1	1	0000 0164	0164 4095	Value = 0°R-3 Value = 0,00228897°R-3,3754 (>0 : normal acceleration)
longitudinal acceleration (g)	5;69 133;197	1;2 3;4	4pps	12	3	4	0000 0041	0041 1023	Value = 0°R+1 Value = 0,002034795°R+1,0834 (<0 : acceleration or nose up)

Example with VHF parameter transmission

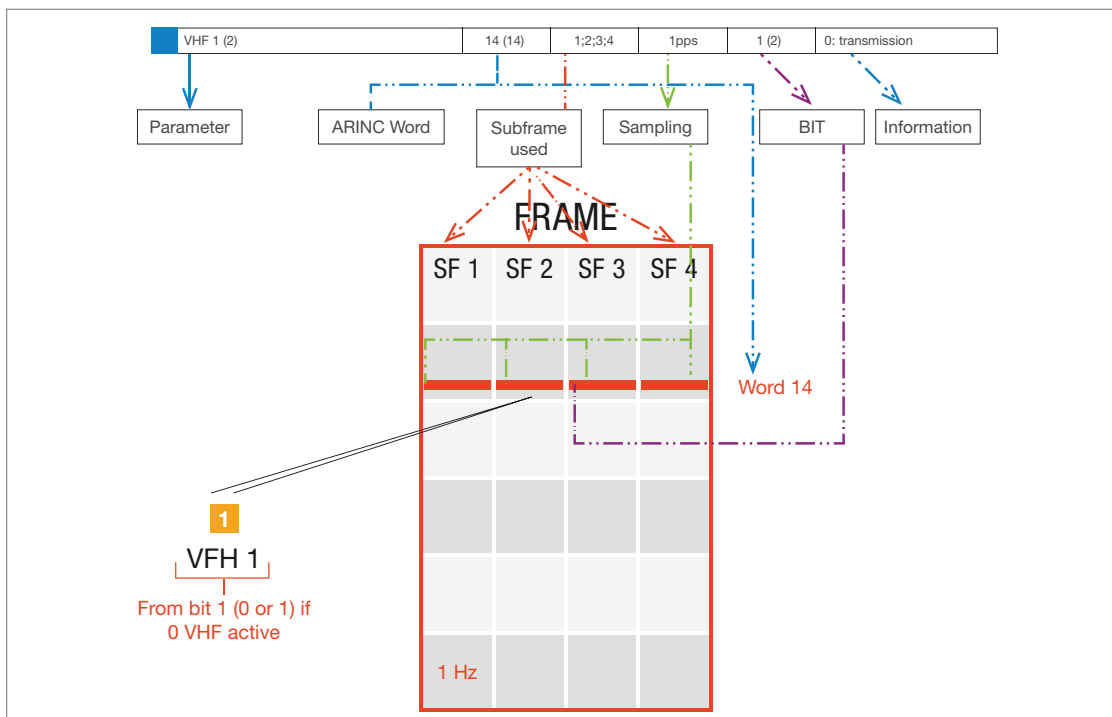

The number of bits used to record parameter depends on the operational range and required accuracy of the parameter. To increase resolution/range several words can be used.

For instance, to record the pitch parameter that ranges (theoretically) from -90° to $+90^\circ$, using 10 bits would give a resolution of $180/2^{10} = 0.176^\circ$. If it is considered not precise enough, another one or two bits can be used.

In the case of the longitude that ranges from -180° to $+180^\circ$, using 12 bits (the maximum in one word) would give a resolution of $360/4096 = 0.0879^\circ$, which corresponds to 5.27 NM at the equator. Then another word can be used to improve the accuracy of the recorded parameter. If 9 extra bits are used, the resolution becomes 0.000172° which corresponds to about 0.01 NM or 20 meters. In such case, the parameter with the highest resolution is generally referred to as "coarse" part and the other as "fine" part.

Dear Readers,

Every effort has been made to ensure document quality.
However please do not hesitate to share your comments and information
with us by using the following address: **ops.support@atr-aircraft.com**

Yours faithfully,

Your ATR Training and Flight Operations support team.

CONTACT

For ordering manuals, please contact us at:

Tel: +33 (0)5 62 21 62 07

e-mail: atc@atr-aircraft.com

ATR Product Support & Services Portal: <https://www.attractive.com>

ATR

1, allée Pierre Nadot

31712 Blagnac cedex - France

Tel: +33 (0)5 62 21 62 21

Fax: +33 (0)5 62 21 68 00



atrbroadcast



atraircraft



atr-aircraft.com



atraircraft



atr



© ATR, 2016. All rights reserved. Proprietary document of ATR. This document shall not be reproduced or disclosed to a third party without the written consent of ATR. This document and its content shall not be used for any purpose other than that for which it is supplied. ATR, its logo, the distinctive ATR aircraft profiles and patented information relating to the ATR aircraft are the exclusive property of ATR and are subject to copyright. This document and all information contained herein are the sole property of ATR. No intellectual property right is granted through, or induced by, the delivery of this document or the disclosure of its content. The statements made herein do not constitute an offer or a representation. They are based on the mentioned assumptions and are expressed in good faith.