



INTERNATIONAL CIVIL AVIATION ORGANIZATION

**REPORT OF THE SECOND MEETING OF
MIDANPIRG MIDAMC STEERING GROUP**

(MIDAMC STG/3)

(Cairo, Egypt 26-28 January 2016)

The views expressed in this Report should be taken as those of the MIDANPIRG MIDAMC Steering Group and not of the Organization. This Report will, however, be submitted to the MIDANPIRG and any formal action taken will be published in due course as a Supplement to the Report.

Approved by the Meeting
and published by authority of the Secretary General

The designations employed and the presentation of material in this publication do not imply the expression of any opinion whatsoever on the part of ICAO concerning the legal status of any country, territory, city or area or of its authorities, or concerning the delimitation of its frontier or boundaries.

TABLE OF CONTENTS

Page

PART I - HISTORY OF THE MEETING

1.	Place and Duration	1
2.	Opening.....	1
3.	Attendance	1
4.	Officers and Secretariat.....	1
5.	Language.....	1
6.	Agenda.....	1-2
7.	Conclusions and Decisions - Definition	2
8.	List of Draft Conclusions and Draft Decisions.....	2

PART II - REPORT ON AGENDA ITEMS

Report on Agenda Item 1	1-1
Report on Agenda Item 2	2-1
Report on Agenda Item 3	3-1/3-2
Report on Agenda Item 4	4-1/4-5
Report on Agenda Item 5	5-1
Report on Agenda Item 6.....	6-1
Report on Agenda Item 7.....	7-1

APPENDICES

Appendix 2A	
Appendix 3A - 3B	
Appendix 4A - 4H	
Appendix 5A	
Appendix 6A	

ATTACHMENT

List of Participants	Attachment A
----------------------------	--------------

PART I – HISTORY OF THE MEETING

1. PLACE AND DURATION

1.1 The Third meeting of the MID ATS Message Management Center Steering Group (MIDAMC STG/3) was held at the ICAO Middle East Regional Office in Cairo, Egypt, from 26 to 28 January 2016.

2. OPENING

2.1 The meeting was opened by Mr. Raza Gulam, RO/CNS, ICAO Middle East Office. Mr. Gulam welcomed all the participants to Cairo and thanked them for their participation.

2.2 Mr. Gulam highlighted the importance of the MIDAMC as successful Regional project and urged the Steering Group to provide their views for the improvement of any of the functions that the MIDAMC provide. He also highlighted that the MIDAMC STG will be responsible for the follow-up of the MID IP Network project, which is an enabler for the implementation of ASBU B1 Modules. He thanked the participants for their presence and wished the meeting every success in its deliberations.

3. ATTENDANCE

3.1 The meeting was attended by a total of twenty four (24) participants, from Eight (8) States (Bahrain, Egypt, Iran, Jordan, Kuwait, Lebanon, Saudi Arabia and United Arab Emirates) and one (1) Organization (SITA). The list of participants is at the **Attachment A**.

4. OFFICERS AND SECRETARIAT

4.1 The meeting was chaired by Ms. Muna Ribhi Alnadaf, Head of AFS Engineering, Civil Aviation Regulatory Commission, Jordan.

4.2 Mr. Raza Gulam RO/CNS was the Secretary of the meeting.

5. LANGUAGE

5.1 The discussions were conducted in English. Documentation was issued in English.

6. AGENDA

6.1 The following Agenda was adopted:

Agenda Item 1: Adoption of the Provisional Agenda

Agenda Item 2: Follow-up on MIDANPIRG/15 and other meetings' Conclusions and Decisions relevant to MIDAMC STG

Agenda Item 3: MIDAMC and AMHS Implementation in the MID Region

Agenda Item 4: Enhancement of the MID AFS Network Services

Agenda Item 5: MIDAMC Functions

Agenda Item 6: Future Work Programme

Agenda Item 7: Any other business

7. CONCLUSIONS AND DECISIONS - DEFINITIONS

7.1 All MIDANPIRG Sub-Groups and Task Forces record their actions in the form of Conclusions and Decisions with the following significance:

- a) **Conclusions** deal with the matters which, in accordance with the Group's terms of reference, merit directly the attention of States on which further action will be initiated by ICAO in accordance with established procedures; and
- b) **Decisions** deal with matters of concern only to the MIDANPIRG and its contributory bodies.

8. LIST OF DRAFT CONCLUSIONS AND DRAFT DECISIONS

DRAFT CONCLUSION 3/1: ENHANCE AFS PERFORMANCE IN MID REGION

DRAFT CONCLUSION 3/2: FTBP TESTING DOCUMENT

DRAFT CONCLUSION 3/3: MID IP NETWORK PROJECT

DRAFT CONCLUSION 3/4: MIDAMC USER MANUAL

DRAFT DECISION 3/5: TERMS OF REFERENCE OF THE MIDAMC STG

PART II: REPORT ON AGENDA ITEMS

REPORT ON AGENDA ITEM 1: ADOPTION OF THE PROVISIONAL AGENDA

1.1 The meeting reviewed and adopted the Provisional Agenda as at Para 6 of the History of the Meeting.

REPORT ON AGENDA ITEM 2: FOLLOW-UP ON MIDANPIRG/15 AND OTHER MEETINGS' CONCLUSIONS AND DECISIONS RELEVANT TO MIDAMC STG

2.1 The subject was addressed in WP/2, WP/14 and WP/17 presented by the Secretariat and UAE. The meeting reviewed the progress made with regard to the implementation of the MIDANPIRG/15 and other meetings' Conclusions and Decisions relevant to MIDAMC as at **Appendix 2A**. The meeting urged States to take necessary measures to expedite the implementation of those Conclusions which have not yet been closed.

2.2 The meeting recalled IATA request for improving the aeronautical messages flow with the AFI Region, mainly the missing of flight plans. The meeting agreed for the establishment of additional Exit/Entry through Khartoum Com Centre, since it has all the necessary requirements for an Exit/Entry Centre. Furthermore, the meeting noted that the ICAO MID Regional Office requested the ICAO ESAF Regional Office to define candidate State in the AFI Region for this additional exit/entry with the MID Region.

2.3 The meeting recalled that the AMHS system is capable of providing delivery reports. Accordingly, the meeting urged States to use this capability with the appropriate procedure for the monitoring of the missing messages in general and flight plan messages in particular; and agreed to the following Draft Conclusion:

DRAFT CONCLUSION 3/1: ENHANCE AFS PERFORMANCE IN MID REGION

That, the MIDAMC develop Regional Procedure for the usage of the AMHS delivery report for enhancement of the MID AFS performance.

2.4 The meeting recognized that the flight plans "ACK" and "REJ" messages are part of the Integrated Flight Plans Processing System (IFPS). In this respect, the meeting recalled that an IFPS Regional project is being considered under the MID ATM Enhancement Programme (MAEP) Framework.

2.5 The meeting was informed that UAE will implement the flight plans "ACK", "MAN" and "REJ" messages for all the flight plans addressed to Emirates ACC on AFTN address OMAEZRZX. The meeting requested UAE to share their procedures and the experience with the Region to the extent possible.

2.6 The meeting noted that in order to meet the increased safety requirements, UAE constantly evaluate regulations and procedures to make improvements. Accordingly, UAE enforced in their AIP (ENR 1.10), new requirements. The meeting encouraged States to notify the national airlines/airports to consult the UAE AIP for the new requirements.

2.7 The meeting encouraged States that have the capability to send "ACK" and "REJ" to use this facility with the appropriate procedures for a trial period and provide their observations to the ATM SG.

REPORT ON AGENDA ITEM 3: MIDAMC AND AMHS IMPLEMENTATION IN THE MID REGION***AMHS Implementations***

3.1 The subject was addressed in WP/3, WP/13 and WP/18 presented by MIDAMC, Lebanon and Egypt. The meeting received the MIDAMC report and progress on AMHS implementation concerning the MID Region as follows:

- a. Eight (8) States have operational AMHS (Egypt, Jordan, Lebanon, Oman, Qatar, Saudi Arabia, Sudan and UAE), and there are Twelve (12) AMHS operational links.
- b. Lebanon has two operational AMHS links one with Amman and the other with Jeddah COM Centres, and has a plan to migrate to AMHS for all international connections.
- c. Iraq installed new AFTN/AMHS system; the system is currently used for AFTN network at national level. Iraq has established IP connections with Jordan and Lebanon over fibre optics with 2 M bandwidth, and plan to do the same with Kuwait.
- d. Iraqi staff, operational and technical have been trained on AMHS. Coordination is undergoing for joining the MIDAMC services and register as MIDAMC users.
- e. The interoperability test between Amman and Baghdad Com Centres is planned for the first quarter of 2016, which will be followed by pre-operational test.
- f. Iraq - Iran AFTN circuit is still under establishment and the meeting urged Iran to provide the ICAO MID Regional Office with the correspondence in order to support the coordination between Iraq and Iran.
- g. Jordan received a request from Ankara COM Centre to support in carrying an AMHS Interoperability test. The test was performed successfully and the link put into operation based on bilateral agreement.

3.2 The meeting noted that the United Kingdom has two Inter-regional AMHS links, one with Singapore COM Centre (WSSS) in ASIA/PAC and the other with the United States of America in NAM/CAR Region. Furthermore, intensive progress in AMHS implementation has been achieved in EUR/NAT Region, after launching the PENS services; many COM Centres have transitioned to AMHS. The existence of IP infrastructure facilitated the transition seamlessly; more than twenty (20) COM Centres have operational AMHS. Accordingly, the meeting urged States to expedite the implementation of the MID IP Network implementation using the APAC CRV framework.

3.3 The meeting recalled that CAAS addressing scheme is the target addressing scheme when AMHS is put into operation. Accordingly, the meeting encouraged Lebanon and Qatar to coordinate with the MIDAMC to fill the pro-forma and submit to ICAO HQ for changing their addressing scheme.

3.4 The meeting recalled MIDANPIRG/14 Conclusion 14/22, urging MID States to provide their AFTN/AMHS/CIDIN Routing tables to MIDAMC by 30 March 2014; the meeting reiterated the Conclusion and urged Iraq, Kuwait, Libya, Oman, Qatar, Syria and Yemen to provide MIDAMC with their routing tables by March 2016.

3.5 The MIDAMC has received many support's requests by email from MID States. The meeting recalled that an Implementers Forum is available at MIDAMC website for all user types and they can interact or share their concern with the MIDAMC team and other MID users. Accordingly, the meeting encouraged all States and users to submit any support request through the Forum.

3.6 The meeting was apprised of AMHS Implementation in Lebanon and the migration plan which showed that Lebanon has seven connections, three (3) of which are CIDIN (Bahrain, Cairo and Cyprus). The meeting urged Bahrain, Egypt and Lebanon to complete the AMHS migration and to remove the CIDIN links.

3.7 The meeting noted that Cairo and Johannesburg had successfully exchanged test messages and agreed to perform a complete interoperability test based on EUR AMHS Manual Doc 20 early February 2016. The aim of the test is proofing the successful use of TCP/IP VSAT link under the NAFISAT. The meeting reviewed Egypt experience and agreed to post the whole process (problem definition, difficulties, and solution) on the MIDAMC forum for the benefit of of the NAFISAT users.

AMHS Communication Paths for ROC

3.8 The subject was addressed in WP/4 presented by the Secretariat. The meeting reviewed and updated the plan to implement AMHS communication paths between Jeddah-Vienna, and Bahrain-Vienna, to enable the exchange of OPMET data in digital format between the MID and EUR Regions as at **Appendix 3A**. It was noted that Athens and Nicosia, which are the entry/exit points between the MID and EUR Regions, had progressed in the procurement of the AMHS.

B0-FICE Monitoring

3.9 The subject was addressed in WP/4 presented by the Secretariat. The meeting reviewed and updated the ASBU B0-FICE monitoring Table contained in the MID Air Navigation Plan Volume III, as at **Appendix 3B**. The meeting had concern on the low level of implementation of the AIDC/OLDI implementation. Accordingly, the meeting encouraged States to use the MID Doc 006 (MID Region Guidance for the implementation of AIDC/OLDI), and conduct bilateral Workshops/Meetings to expedite the implementation in order to achieve the MID Air Navigation Strategy performance targets related to AIDC/OLDI implementation.

REPORT ON AGENDA ITEM 4: ENHANCEMENT OF THE MID AFS NETWORK SERVICES***Dynamic Routing in the MID Network***

4.1 The subject was addressed in WP/6 and WP/12 presented by Iran and MIDAMC. The current static routes in AFS do not allow for the automatic failover or redundant paths, thus if failure occurs, operators must manually adjust the routes to move data through an alternate path. In order to enhance the availability, reliability of the AFS Network and minimize downtime to the minimum, dynamic routing can be deployed. Dynamic routing protocols can update routing tables in the event of device or interface failure, thus if there are multiple possible paths, these protocols will continue to allow data flow. However, to achieve this stage detailed studies and trials are required.

4.2 To perform these trials, States should have, among others Backup/Test AMHS System, Operational AMHS Link, Human Resources (Network Expert, System Engineer, AFS Operator); and Vendor support is also needed. The conduct of survey indicated that many States do not have these requirements.

4.3 The meeting noted the MID Region initiative to join the CRV project with APAC Region, which will provide same Network performance in terms of availability, quality and reliability. Accordingly, the meeting agreed to postpone any study or trials on the dynamic routing, until decision is taken on the CRV.

Proposals for Amendment of Annex 10, Volume II

4.4 The subject was addressed in WP/5 presented by the Secretariat. The meeting reviewed the Proposal for Amendment of Annex 10, Vol II, issued under SL AN 7/1.3.104-15/31 dated 24 April 2015, related to AFTN. The proposal contains new provisions, which address limitations to the current AFTN system in terms of message line length, overall message length and the limited character set.

4.5 The meeting had concerns on the proposal especially that the AFTN as described in Annex 10, Vol II, cannot support special characters used in the eXtensible Markup Language (XML). The other concern was on the Note under Para 4.4.15.4, since the originator does not know whether the message text requires conversion or not.

4.6 The meeting was informed that these concerns were thoroughly studied at the ICAO HQ and the wording of the final Amendment underwent significant change although the intent did not change and the revised version of the Amendment along with other amendments is at **Appendix 4A**.

File Transfer Body Part (FTBP) Trial

4.7 The subject was addressed in WP/12 presented by the MIDAMC. The World Meteorological Organization (WMO) initially decided to migrate from alphanumeric codes to BUFR for the representation of Meteorological data; therefore, ATS Extended service was introduced to meet the Meteorological requirement. At a later stage, the WMO decided to use XML.

4.8 The meeting recalled that most of the ATS systems in the MID Region can run the extended services and especially File Transfer Body Part (FTBP), and these services can provide significant operational improvements. Accordingly, the MIDANPIRG/15 meeting agreed that trials be conducted for the use of extended services.

4.9 Based on the above, the meeting agreed that a trial will be conducted between Jordan and Egypt (May 2016). In this regard, the meeting reviewed and updated the ATS Extended Trial Team members as at **Appendix 4B**. Furthermore, the meeting reviewed testing document for the FTBP trial, as at **Appendix 4C**, and agreed to the following Draft Conclusion:

DRAFT CONCLUSION 3/2: FTBP TESTING DOCUMENT

That, the first edition of File Transfer Body Part trial and testing document at Appendix 4C is endorsed; and be published as MID Document.

Removal of CIDIN

4.10 The subject was addressed in WP/9 presented by the MIDAMC. The meeting noted that Five (5) States in the MID Region have CIDIN links (Bahrain, Egypt, Lebanon, Saudi, and UAE), and all these States already have AMHS system in place. The meeting urged States to take necessary measures and seek the support from MIDAMC Team.

European Directory Service (EDS)

4.11 The subject was addressed in WP/12 presented by the MIDAMC. The use of ATN Directory services is tailored to the establishment of repositories for distribution lists, public keys to support secure messaging, and correspondent AMHS and non-AMHS user address. In this context the following tasks have been carried out; the Development of EDS Operational Concept, Installation and testing two central DSAs (test, operational), Development of EDS Documentations, Integration of the EDS in ICAO documents including ICAO Doc 9880, EUR Doc 020 (EUR/AMHS Manual) and EUR Doc 021 (ATS Messaging Management Manual) and training all European COM Centres on EDS. Moreover, the validation of the EDS Operational Concept has been carried out in 2014.

4.12 Following the EUR AFSG18 Decision, EUROCONTROL performed the following tasks for EDS operation:

- the operational central DSA is setup and configured;
- the central DSA at EUROCONTROL was connected to the operational PENS Messaging VPN;
- all EDS documents have been updated, including EDS User Interface Document, EDS Test Document and Appendix B/Appendix G of EUR/AMHS Manual;
- three dedicated AMC/EDS training sessions have been scheduled for 2015, 2016 and 2017; and
- since the 3rd Quarter of 2015, all AMC operational data (AMHS addresses, user capabilities, user lookup tables and routing tables) has been copied to the EDS in each AIRAC cycle.

4.13 The meeting encouraged States to follow-up the development and requested the MIDAMC manager to attend AMC/EDS Training, in order promote/support the directory services in the MID Region.

SITA-AMHS

4.14 The subject was addressed in WP/7 and WP/8 presented by SITA. The meeting reviewed the SITA-AMHS gateway interconnection topology as at **Appendix 4D** and noted that SITA is currently engaged with Jordan to prepare for IP network connectivity and AMHS Interoperability Testing, which is progressing well. Similar effort is initiated for AMHS interconnection with Qatar. The meeting supported the efforts and requested that a progress report to be provided through the MIDAMC on quarterly basis or when necessary. The meeting was informed that Lebanon has an AFTN connection with SITA and is interested to migrate to IP and has additional connection for the Region. Furthermore, the meeting discussed in detail the charges from SITA to State. SITA confirmed that they do not charge the State for the Set-up or the traffic exchange. Charges only occur if State signs contract with SITA for specific services.

4.15 The meeting noted that the ICAO EUR AFSG/19 meeting, proposed that FAA organize a Coordination Workshop in Atlanta, United States, where the SITA gateway and the Atlanta COM Centre reside in order to promote common principles, exchange information, experiences and resolve/clarify outstanding issues related to SITA interconnections and migration to AMHS.

4.16 Based on the above, the Workshop was organized (12-14 August 2015). It resulted in drafting the migration plan document and an update to the AMHS-SITA Interconnection Architecture document. The meeting reviewed the current version of the document at **Appendix 4E**, that integrated all comments received from the Workshop participants. The meeting encouraged States to further review and provide comments to the ICAO MID Regional Office by **20 February 2016**, in order to share with the other ICAO Regions.

4.17 The meeting noted the introduction of SITA PRMD in EUR AMC, and the SITA users addresses are to be published in AMC on 4 February 2016 and activated on AIRAC 1603 cycle on 3 March 2016. The meeting tasked the MIDAMC to closely follow the activity and provide necessary support, and reports to the ICAO MID Regional Office any difficulties in order to share it with all concerned.

Mechanism to Support AMHS in Implementation Phase

4.18 The subject was addressed in WP/9 presented by the MIDAMC. The meeting was apprised of the implementers' forum on the MIDAMC for sharing information and experience between members and provide technical support. The MIDAMC Team proposed proactive means to support AMHS Implementation in the Region as follows:

- a) posting Guidance Material (EUR ICAO 020 and ICAO EUR 021) into Documentation subpage at the MIDAMC;
- b) posting template of Interoperability test Configuration and Report documents;
- c) posting template of pre-operational test Configuration and Report documents; and
- d) posting all requests received by email into the Implementers forum and sending notifications to all MIDAMC Users.

4.19 The meeting commended the above actions from the MIDAMC and encouraged States to use all the above support for the AMHS related issues.

AFS Contingency Plan for the MID Region

4.20 The subject was addressed in PPT/1, PPT/2 and WP/16 presented by Lebanon, Saudi Arabia and UAE. The meeting received with appreciation information from Lebanon, Saudi Arabia and UAE on the contingency planning for the AFS in their States. Accordingly, the meeting had brain storming session on the AFS contingency plan for the MID Region. The brain storming covered the content of the plan and developed requirements of the contents of the plan as at **Appendix 4F**. The meeting agreed that the whole plan to be completed through correspondence and teleconference and presented to the CNS SG/7 for review and update.

Establishment of the MID IP Network and CRV

4.21 The subject was addressed in WP/10 presented by the Secretariat. The meeting noted that the Second meeting of the MID ATM Enhancement Programme Steering Committee (MAEP SC/2), prioritized the implementation of the agreed regional projects for the MID, among them was the MID IP Network with high priority.

4.22 The MAEP SC/2 meeting reviewed the MID IP Network Project Proposal Document developed by the MID IP Network Action Group, and was also apprised of the progress made in the implementation of the Common Regional Virtual Private Network Programme (CRV) in the APAC Region. In this respect, it was highlighted that CRV Task Force was created end 2013 under APANPIRG. The CRV became a programme that will expectedly become a safe and secured IP-based transportation service offered to CRV users from 2017 onwards through a common contractual framework. This common contractual framework will be responsible for the ongoing sealed tender process to successfully select a best and final offer which is under process and will be finalized expectedly by 3 March 2016. The ongoing sealed tender process makes it possible for all MID States, and more users, to join this initiative.

4.23 The meeting noted that the challenges related to the implementation of the IP Network Project, the cost-benefit analysis and preliminary safety analysis have been carried out in the APAC Region and the procurement process is through an ICAO TCB project. An Expert was appointed to support the Call for Tender Process for the selection of the Telecommunication Service Provider (CRV supplier). It was highlighted that the CRV users will have to sign individual service contract (based on a template) with the CRV supplier. The CRV procurement includes all ICAO MID States as potential users.

4.24 The meeting reviewed the three scenarios for the development and implementation of the MID IP Network as were discussed at the MAEP SC/2:

- a. MID Region drives its own IP-based network project and uses CRV procurement framework for all regional and interregional connections.
- b. MID Region drives its own IP-based network project and uses CRV procurement framework only for interregional connections along the major traffic flows.
- c. MID Region drives its own IP-based network project and does not use at all the CRV procurement framework.

4.25 The meeting was in consensus with the MAEP SC/2 agreement that scenario (a) is the best scenario for the development and implementation of the MID IP Network and that close coordination with APAC through the ICAO Bangkok Regional Office should be carried out in order to use the CRV procurement framework for the implementation of the MID IP Network.

4.26 The meeting noted that the MID IP Network Workshop was organized (Cairo, 24-25 January 2016) with the support from the APAC Region. The Workshop addressed all issues related to the development and implementation of the MID IP Network using the CRV procurement framework.

4.27 In connection with the above, it was highlighted that a structure for managing the network once commissioned will need to be established (governing body). In the APAC a CRV Operations Group (CRV-OG) will be established and States/Administrations will have to join the CRV-OG before signing an individual service contract with the selected supplier. The meeting agreed on the same structure for the MID Region.

4.28 The meeting supported the MID IP Network Workshop recommendations as at **Appendix 4G** and agreed that the CRV to be renamed as Common aeRonautical VPN (CRV) in order to represent both Regions. Furthermore, the meeting noted that during the Workshop an initial basic local CBA was conducted for Jordan and UAE; the results were promising. Accordingly, the meeting encouraged all States to provide the necessary information to the ICAO MID Regional Office to support the conduct of initial local CBA.

4.29 The meeting noted that, based on the MAEP SC/2, *Draft Conclusion 2/3: MID IP Network Project*, the ICAO MID Regional Office issued a State Letter to seek States commitment to the MID IP Network and to provide necessary information. In this respect, the meeting reviewed and updated the table of replies as at **Appendix 4H**. The meeting urged all States to join the CRV and agreed to the following Draft Conclusion:

DRAFT CONCLUSION 3/3: MID IP NETWORK PROJECT (CRV)

That,

- a) the MID IP Network Project be renamed as Common aeRonautical VPN Network (CRV) in order to be one common IP Network with the APAC;*
- b) States that did not confirm their commitment to join the CRV, be urged to do so before **1 March 2016**; and*
- c) ICAO to support States for the conduct of the local CBA, provided that the States send their information to the ICAO MID Regional Office by **1 March 2016**.*

REPORT ON AGENDA ITEM 5: MIDAMC FUNCTIONS

5.1 The subject was addressed in WP/3 and WP/15 presented by the MIDAMC. The meeting recalled that, the MIDAMC provides, among others the following main tasks on daily basis to support its operations:

- a. regular email update at each AIRRAC date;
- b. check the routing tables for consistency;
- c. register new Users;
- d. keep the Network Inventory data updated;
- e. coordinate and communicate with MID Users and support AMHS Planning and Implementation when required;
- f. synchronize the ATS Addresses with the EURAMC; and
- g. move data between MIDAMC Areas according to the MIDAMC AIRAC phases.

5.2 The meeting encouraged the use of the forum on the MIDAMC website instead of the emails in order to share the experience on the problems and solutions among the users.

5.3 The meeting noted that new users from AFI Region have been registered as external users to the MIDAMC, according to the agreed accreditation procedures.

5.4 The meeting recalled that the MIDAMC training held in Amman (5-7 January, 2015), recommended the development of MIDAMC User Manual. Accordingly, MIDAMC developed the MIDAMC User Manual that will guide the users on how to use the MIDAMC functions and tools. The meeting reviewed and updated the User Manual as at **Appendix 5A**, and agreed to the following Draft Conclusion:

DRAFT CONCLUSION 3/4: MIDAMC USER MANUAL

*That, the first edition of the MIDAMC User Manual at **Appendix 5A** is endorsed; and be published as MID Document.*

REPORT ON AGENDA ITEM 6: FUTURE WORK PROGRAMME

6.1 The subject was addressed in WP/11 presented by the Secretariat. The meeting reviewed the MIDAMC STG Terms of References (TORs) and agreed that they are still valid and current. However, it was agreed that, the MIDAMC STG to follow-up the IP Network Project until the MID CRV-OG (named Common aeRonautical VPN – Operational Group) is established. Accordingly, the meeting added this task and developed a revised TOR as at **Appendix 6A** and agreed to the following Draft Decision:

DRAFT DECISION 3/5: TERMS OF REFERENCE OF THE MIDAMC STG

*That, the Terms of Reference and Work Programme of the MIDAMC STG be updated as at **Appendix 6A**.*

6.3 Taking into consideration, the planned ICAO MID Regional events which are of relevance to the activity of the MIDAMC Steering Group, in particular the CNS SG/7, MSG/5, ANSIG/2 and MIDANPIRG/16 meetings, it was agreed that the MIDAMC STG/4 meeting be held during the first half of 2017. The venue will be Cairo, unless a State is willing to host the meeting

REPORT ON AGENDA ITEM 7: ANY OTHER BUSINESS

7.1 Noting has been discussed under this Agenda Item.

APPENDICES

APPENDIX 2A

FOLLOW-UP ACTION PLAN ON MIDANPIRG/15 CONCLUSIONS AND DECISIONS

CONCLUSIONS AND DECISIONS	FOLLOW-UP	TO BE INITIATED BY	DELIVERABLE	TARGET DATE	REMARKS
<p>CONCLUSION 15/10: MID REGION AIR NAVIGATION STRATEGY</p> <p>That,</p> <p>a) the revised MID Region Air Navigation Strategy:</p> <p>i. is endorsed as the framework identifying the regional air navigation priorities, performance indicators and targets; and</p> <p>ii. be published as MID Doc 002.</p> <p>b) MID States be urged to:</p> <p>i. develop their National Air Navigation Performance Framework, ensuring the alignment with and support to the MID Region Air Navigation Strategy; and</p> <p>ii. provide the ICAO MID Regional Office, on an annual basis (by the end of November), with relevant data necessary for regional air navigation planning, reporting and monitoring.</p>	Implement the Conclusion	MIDANPIRG/15 ICAO ICAO States States	MID AN Strategy MID Doc 002 State Letter National Performance Framework Feedback	Nov. 2015 Nov. 2015	Actioned SL AN 1/7–15/191 dated 25 June 2015 MID Doc 002 published
<p>CONCLUSION 15/11: ENDORSEMENT OF THE MID eANP</p> <p>That,</p> <p>a) the new MID ANP VOL I, II and III available at: http://www.icao.int/MID/MIDANPIRG/Pages/Final%20Report/MID-eANP.aspx are endorsed; and</p> <p>b) the ICAO MID Regional Office process the necessary Proposals for Amendment, in accordance with the procedure for amendment approved by the Council, for formal approval by the end of 2015.</p>	Issue Proposals for Amendment	ICAO	Proposals for Amendment	Dec. 2015	Actioned Pfa to VOL I was issued Ref.: AN 5-6-7-8-10-13/5A – 15/300 dated 18 November 2015

CONCLUSIONS AND DECISIONS	FOLLOW-UP	TO BE INITIATED BY	DELIVERABLE	TARGET DATE	REMARKS
<p>DECISION 15/12: DISSOLUTION OF THE ANP AD-HOC WORKING GROUP</p> <p>That, the ANP Ad-Hoc Working Group is dissolved.</p>	Implement the Conclusion	MIDANPIRG/15	Dissolve ANP WG	Jun. 2015	Completed
<p>CONCLUSION 15/18: MID REGIONAL GUIDANCE FOR IMPLEMENTATION OF AIDC/OLDI</p> <p>That, the MID Region guidance for the implementation of AIDC/OLDI (Edition 1.1, June 2015) is endorsed as MID Doc 006.</p>	Implement the Conclusion	MIDANPIRG/15	MID Region Guidance for AIDC/OLDI3	Jun. 2015	Completed MID Doc 006 endorsed
<p>CONCLUSION 15/19: REGIONAL PERFORMANCE DASHBOARDS</p> <p>That, ICAO expedites the expansion of the regional performance dashboards to include the MID Region-specific indicators, metrics and targets, for which the necessary data is available.</p>	Implement the Conclusion	ICAO	Dashboards with Regional indicators, metrics and targets	Dec. 2015	Ongoing
<p>CONCLUSION 15/20: MID REGION ATM CONTINGENCY PLAN</p> <p>That, the MID Region ATM Contingency Plan (Edition June 2015):</p> <p>a) is endorsed as MID Doc 003; and</p> <p>b) be used by States and concerned stakeholders to ensure the orderly flow of international air traffic in the event of disruptions of air traffic services and related supporting services and to preserve the availability of major world air routes within the air transportation system in such circumstances.</p>	Implement the Conclusion	MIDANPIRG/15	MID Region ATM Contingency Plan MID Doc 003	Jun. 2015	Completed MID Doc 003 published

CONCLUSIONS AND DECISIONS	FOLLOW-UP	TO BE INITIATED BY	DELIVERABLE	TARGET DATE	REMARKS
<p>CONCLUSION 15/30: AFTN/CIDIN AFS CONNECTIVITY AND AMHS IMPLEMENTATION</p> <p>That States be urged to:</p> <ul style="list-style-type: none"> a) refrain from establishing new AFTN and CIDIN connections at the International level; b) gradually phase out the current connections based on AFTN or CIDIN standards; and c) expedite their AMHS implementation. 	Implement the Conclusion	ICAO	State Letter	July 2015	To be closed SL AN 7/5.1-15/209 dated 8 Jul. 2015
<p>CONCLUSION 15/31: MIDAMC ACCREDITATION PROCEDURE</p> <p>That, the accreditation procedure for registering in the MIDAMC be amended as at Appendix 5.2.2G.</p>	Amend the procedure	MIDANPIRG/15	The procedure amended	June 2015	Completed
<p>CONCLUSION 15/35: AIR NAVIGATION DEFICIENCIES</p> <p>That, States be urged to:</p> <ul style="list-style-type: none"> a) use the MID Air Navigation Deficiency Database (MANDD) for the submission of requests for addition, update, and elimination of Air Navigation Deficiencies, including the submission of a specific Corrective Action Plan (CAP) for each deficiency; and b) submit a Formal Letter to the ICAO MID Regional Office containing the evidence(s) that mitigation measures have been implemented for the elimination of deficiency(ies) when requesting the elimination of deficiency(ies) from the MANDD. 	Implement the Conclusion	ICAO States	State Letter CAP and necessary updates/ evidences	When necessary	Ongoing

FOLLOW-UP ACTION PLAN ON MAEP SC/2 CONCLUSIONS AND DECISIONS

CONCLUSIONS AND DECISIONS	FOLLOW-UP	TO BE INITIATED BY	DELIVERABLE	TARGET DATE	REMARKS
<p>DRAFT CONCLUSION 2/3: MID IP NETWORK PROJECT</p> <p>That,</p> <p>a) the MID IP Network Project use the procurement framework of the APAC Common Regional Virtual Private Network Programme (CRV);</p> <p>b) States be urged to confirm their commitment to go ahead with the implementation of the MID IP Network using the APAC CRV procurement framework, and provide necessary information; and</p> <p>c) a joint APAC/MID IP Network Workshop be organized as soon as possible (early 2016) to address all issues related to the implementation of the MID IP Network.</p>	<p>Conduct WS</p>	<p>ICAO States</p>	<p>SL WS</p>	<p>Jan2016</p>	<p>SL AN 6/31.4-15/312 dated 4 Nov. 2015</p>

APPENDIX 3A

AMHS Plan for ROC in Jeddah and Bahrain					
	Task	Timeframe	Assigned to	Champion	Status
<i>AMHS Intra-regional Trunk Connections</i>					
1	Establish Jeddah – Beirut IP Network	Jul 2015	Saudi Lebanon	IM MS	
2	Establish Bahrain – Beirut IP Network	Feb 2016	Bahrain Lebanon	YH MS	Already in progress
3	Establish Cairo – Beirut IP Network	Jun 2016	Egypt Lebanon	AF//MR MS	
4	Establish Bahrain – Jeddah IP Network	Mar 2016	Bahrain Saudi	IM YH	
5	Perform the Interoperability test between Jeddah and Beirut COM centers	July 2015	Saudi Lebanon	IB MS	DONE
6	Perform the Interoperability test between Bahrain and Beirut COM centers	Feb 2016	Bahrain Lebanon	MS YH	
7	Perform the Interoperability test between Cairo and Beirut COM centers	June 2016	Egypt Lebanon	AF/TZ/MR MS/EK	Depends on IP network availability
8	Perform the Interoperability test between Bahrain and Jeddah COM centers	Mar 2016	Bahrain Saudi	YH IM	
9	Perform the Pre-operational test between Jeddah and Beirut COM centers	July2015	Saudi Lebanon	IM MS	Done
10	Perform the Pre-operational test between Bahrain and Beirut COM centers	Feb 2016	Bahrain Lebanon	YH MS	
11	Perform the Pre-operational test between Cairo and Beirut COM centers	July 2016	Egypt Lebanon	AF/ /MR MS/EK	
12	Perform the Pre-operational test between Bahrain and Saudi COM centers	Nov 2015	Bahrain Saudi	YH IM	
13	Place the AMHS link into operation between Jeddah and Beirut COM centers, and updating the Routing tables	Jul 2015	Saudi Lebanon MID AMC	IM MS/EK MN	Done
14	Place the AMHS link into operation between Bahrain and Beirut COM centers , and updating the Routing tables	Mar 2016	Bahrain Lebanon MID AMC	YH MS/EK MN	
15	Place the AMHS link into operation between Cairo and Beirut COM centers, and updating the Routing tables	Aug 2016	Egypt Lebanon MID AMC	AF/TZ/MR MS/EK MN	
16	Evaluate the Trunks connections bandwidth and increase it if required between (Bahrain, Beirut, Cairo and Jeddah)	Jun 2016	Bahrain Beirut Cairo Jeddah	YH MS/EK AF/TZ IM	Depends on testing of digital data exchanged

<i>The AMHS Interconnection with EUR Region Depends on Nicosia and Athens</i>					
17	Establish Cairo – Tunis IP Network	<i>March 2016 July 2016</i>		AF/TZ/MR IB/MA	Both Egypt and Tunisia Ready Coordination in process to implement
18	Establish Nicosia – Beirut IP Network	<i>Awaiting reply from EUR</i>		MS/EK	Lebanon ready
19	Establish Nicosia – Jeddah IP Network			IM	Saudi Arabia ready
20	Establish Bahrain – Nicosia IP Network			YH	
21	Establish Cairo – Athens IP Network			AF/TZ/MR	Egypt Ready Link is ready as same CIDIN link will be used
22	Perform the Interoperability test between Cairo and Tunis COM centers	<i>April 2016 August 2016</i>		AF/ /MR IB/MA	Both Egypt and Tunisia Ready Coordination in process to implement
23	Perform the pre operational test between Cairo and Tunis COM centers	<i>Mai 2016 August 2016</i>		AF/ /MR IB/MA	Both Egypt and Tunisia Ready Coordination in process to implement
24	Place the AMHS link into operation between Cairo and Tunis COM centers, and updating the Routing tables	<i>Mai 2016</i>		AF/ /MR IB/MA	Both Egypt and Tunisia Ready Coordination in process to implement
25	Perform the Interoperability test between Athens and Cairo COM centers	Mar 2017		AF/TZ/MR IB/MA	Athens advised that their system will be installed by Dec. 2016
26	Perform the Interoperability test between Bahrain and Nicosia COM centers			YH	
27	Perform the Interoperability test between Nicosia and Jeddah COM centers			IM	
28	Perform the Interoperability test between Nicosia and Beirut COM centers			MS/EK	Nicosia in tender process
29	Perform the Pre-operational test between Athens and Cairo COM centers	Mar 2017		AF/TZ/MR	Athens advised that their system will be installed by Dec 2016
30	Perform the Pre-operational test between Bahrain and Nicosia			YH	

	COM centers				
31	Perform the Pre-operational test between Nicosia and Beirut COM centers			MS/EK	
32	Perform the Pre-operational test between Nicosia and Jeddah COM centers			IM	
33	Place the AMHS link into operation between Athens and Cairo COM centers, and updating the Routing tables	Mar 2017		MIDAMC AF/ /MR	same
34	Place the AMHS link into operation between Bahrain and Nicosia COM centers , and updating the Routing tables			MID AMC YH	
35	Place the AMHS link into operation between Nicosia and Jeddah COM centers, and updating the Routing tables			MID AMC IM	
36	Place the AMHS link into operation between Nicosia and Beirut COM centers, and updating the Routing tables			MS/EK	
37	Evaluate the inter-region connections bandwidth and increase it if required			MID AMC	
38	Transition of all regional AFTN/CIDIN Connections to AMHS	Q1, 2017	All MID States		

Champions:

Bahrain: (YH: Yaseen Hasan)

Egypt: (AF:Ahmed Farghally/TZ:Tarek Zaki/MR: Mohamed Ramzi/Essam Helmi: EH)

Lebanon: (MS: Mohamad Saad / EK: Elias El-Khoury)

Saudi Arabia: (IM: Mr. Ibraheem Mohamed Basheikh)

Tunis: IB: Issam Bouzid / MA: Mr. Mohamed Ali)

MID AMC/Jordan: MN: Muna Ribhi Alnadaf

APPENDIX 3B

B0 – FICE: Increased Interoperability, Efficiency and Capacity through Ground-Ground Integration

Description and purpose

To improve coordination between air traffic service units (ATSUs) by using ATS Interfacility Data Communication (AIDC) defined by the ICAO *Manual of Air Traffic Services Data Link Applications* (Doc 9694). The transfer of communication in a data link environment improves the efficiency of this process particularly for oceanic ATSUs.

Main performance impact:

KPA- 01 – Access and Equity	KPA-02 – Capacity	KPA-04 – Efficiency	KPA-05 – Environment	KPA-10 – Safety
N	Y	Y	N	Y

Applicability consideration:

Applicable to at least two area control centres (ACCs) dealing with enroute and/or terminal control area (TMA) airspace. A greater number of consecutive participating ACCs will increase the benefits.

B0 – FICE: Increased Interoperability, Efficiency and Capacity through Ground-Ground Integration

<i>Elements</i>	<i>Applicability</i>	<i>Performance Indicators/Supporting Metrics</i>	<i>Targets</i>
AMHS capability	<i>All States</i>	Indicator: % of States with AMHS capability Supporting metric: Number of States with AMHS capability	70% of States with AMHS capability by Dec. 2017
AMHS implementation /interconnection	<i>All States</i>	Indicator: % of States with AMHS implemented (interconnected with other States AMHS) Supporting metric: Number of States with AMHS implemented (interconnections with other States AMHS)	60% of States with AMHS interconnected by Dec. 2017
Implementation of AIDC/OLDI between adjacent ACCs	<i>All ACCs</i>	Indicator: % of FIRs within which all applicable ACCs have implemented at least one interface to use AIDC/OLDI with neighboring ACCs Supporting metric: Number of AIDC/OLDI interconnections implemented between adjacent ACCs	70% by Dec. 2017

TABLE B0-FICE

EXPLANATION OF THE TABLE

Column

- 1 Name of the State
- 2, 3, 4 Status of AMHS Capability and Interconnection and AIDC/OLDI Capability, where:
Y – Fully Implemented
N – Not Implemented
- 5 Status of AIDC/OLDI Implementation, where:
Y – If AIDC/OLDI is implemented at least with one neighbouring ACC
N – Not Implemented
- 6 Action plan — short description of the State’s Action Plan with regard to the implementation of B0-FICE.
- 7 Remarks

State	AMHS Capability	AMHS Interconnection	AIDC/OLDI Capability	AIDC/OLDI Implementation	Action Plan	Remarks
<i>1</i>	<i>2</i>	<i>3</i>	<i>4</i>	<i>5</i>	<i>6</i>	<i>7</i>
Bahrain	Y	N	Y	N	Feb 2016 for AMHS Int.	OLDI Under test with Doha
Egypt	Y	Y	Y	Y		
Iran	N	N	Y	N		Contract signed for AMHS
Iraq	Y	N	N	N	AMHS Conn with AMMAN in Mar 2016	
Jordan	Y	Y	Y	N		
Kuwait	Y	N	Y	N	July 2016 for AMHS Int.	
Lebanon	Y	Y	Y	MS to confirm		OLDI implemented by no LOA
Libya	Y	N	Y	N		
Oman	Y	Y	Y	N		
Qatar	Y	Y	Y	Y		local implementation for OLDI
Saudi Arabia	Y	Y	Y	Y		local implementation for AIDC
Sudan	Y	Y	Y	N		
Syria	N	N	N	N		
UAE	Y	Y	Y	Y	Q2-2016	Local implementation for OLDI
Yemen	N	N	N	N		Contract signed for AMHS
Total Percentage	80%	53 %	80%	26.6%		

APPENDIX A

IMPLEMENTATION TASK LIST AND OUTLINE OF GUIDANCE MATERIAL IN RELATION TO AMENDMENT 90 TO ANNEX 10, VOLUME II

1. IMPLEMENTATION TASK LIST

Aeronautical fixed telecommunication network (AFTN) and new message types

1.1 Essential steps to be followed by a State in order to implement the proposed amendment to Annex 10, Volume II:

- a) identification of the need to modify the AFTN to handle new message types and subsequent coordination and agreement with the States concerned. This should include a cost-benefit analysis;
- b) identification of the rule-making process necessary to transpose the amendments into the national regulations taking into consideration the applicability dates;
- c) drafting of the modification(s) to the national requirements and means of compliance;
- d) official adoption of the national requirements and/or means of compliance;
- e) development of an implementation plan, including timelines, to confirm compliance for each applicable air navigation service provider;
- f) approval of the installation of new equipment or upgrade of existing equipment to comply with applicable requirements; and
- g) operational acceptance of policy and procedures of ANSP(s) and to comply with applicable requirements.

Data link initiation capability (DLIC), automatic dependent surveillance — contract (ADS-C), controller-pilot data link communications (CPDLC) and satellite voice communications (SATVOICE)

1.2 Essential steps to be followed by a State in order to implement the proposed amendment to Annex 10, Volume II.

- a) identification of the need for amendment of national requirements;
- b) drafting of the modification(s) to the national requirements, if applicable and means of compliance;
- c) official adoption of the national requirements and/or means of compliance; and

- d) revision of guidance material and checklists for applicable inspectors (flight operation, airworthiness and air navigation service providers (ANSPs).

2. STANDARDIZATION PROCESS

- 2.1 Effective date: [D] July 2016
 2.2 Applicability date: 10 November 2016
 2.3 Embedded applicability date(s): N/A

3. SUPPORTING DOCUMENTATION

3.1 ICAO documentation

Title	Type (PANS/TI/Manual/Circ)	Planned publication date
<i>ICAO Annex 3 – Meteorological Service for International Air Navigation</i>	Annex	2016
<i>ICAO Annex 15 – Aeronautical Information Services.</i>	Annex	2016
<i>Global Operational Data Link (GOLD) Manual (Doc 10037)</i>	Manual	2016
<i>Performance-based Communication and Surveillance Manual (Doc 9869)</i>	Manual	2016
<i>Satellite Voice Operations Manual (Doc 10038)</i>	Manual	2016

3.2 External documentation

Title	External Organization	Publication date
Nil		

4. IMPLEMENTATION ASSISTANCE TASKS

Type	Global	Regional
Nil		

5. UNIVERSAL SAFETY OVERSIGHT AUDIT PROGRAMME (USOAP)

- 5.1 No additional USOAP CMA protocol questions or modifications to existing questions are proposed.

APPENDIX B

IMPACT ASSESSMENT IN RELATION TO AMENDMENT 90 TO ANNEX 10, VOLUME II

1. INTRODUCTION

1.1 The amendment proposals to Annex 10, Volume II contain new provisions which address limitations to the current aeronautical fixed telecommunication network (AFTN) system in terms of message line length, overall message length and the limited character set.

1.2 This proposal was consequential to new operational requirements called for in:

- a) Amendment 76 to Annex 3 — *Meteorological Service for International Air Navigation*
- b) Amendment 37 to Annex 15 — *Aeronautical Information Services*
- c) Amendment 1 to the *Procedures for Air Navigation Services — Air Traffic Management* (PANS-ATM, Doc 4444); and
- d) Amendment 77 to Annex 3 envisaged to be applicable in 2016 and the envisaged Amendment 78 to Annex 3 expected to be applicable in 2018.

1.3 In addition to the above, changes have been made to ensure consistency between Annex 10, Volume II and other ICAO documents. Specifically, references to the *Manual of Technical Provisions for the Aeronautical Telecommunication Network (ATN)* (Doc 9705) have been replaced with references to its successor, the *Manual on Detailed Technical Specifications for the Aeronautical Telecommunication Network (ATN) using ISO/OSI Standards and Protocols* (Doc 9880). In addition to this, references to the common ICAO data interchange network/aeronautical message handling service (CIDIN/AMHS) gateways have been deleted.

1.4 The amendment proposal to Annex 10, Volume II also clarifies the terms and the existing provisions related to DLIC, ADS-C and CPDLC and adds reference to guidance material to support implementation of SATVOICE.

2. IMPACT ASSESSMENT

2.1 *Safety impact:*

2.1.1 As the amendments related to AFTN are consequential to amendments to Annexes 3 and 15, any impact on safety will be the result of the implementation of those amendments. These amendments support the ASBU D-AIM modules.

2.1.2 Clarification on data link initiation failure procedures brought by this amendment will have positive safety impact as the correct implementation of the procedure is safety critical, in particular for operations in oceanic and remote areas.

2.2 *Financial impact:*

2.2.1 The amendments related to AFTN are optional and only apply to those States who have not implemented the aeronautical message handling system (AMHS). As this amendment is consequential to amendments to Annexes 3 and 15, the financial impact will be driven by the considerations to implement those particular amendments. In many cases, States will already have this capability with no financial impact.

2.2.2 No significant financial impact is expected as the amendments concerning DLIC, ADS-C, CPDLC and SATVOICE are purely procedural in nature and will not require any installation and/or upgrade of data link and SATVOICE systems.

2.3 *Security impact:*

2.3.1 The amendment regarding the handling of new message types by the aeronautical fixed telecommunication network (AFTN) is considered neutral from a security perspective.

2.3.2 No security impact is expected with the amendment concerning DLIC, ADS-C, CPDLC and SATVOICE.

2.4 *Environmental impact:*

2.4.1 The optional changes brought about by the amendments related to AFTN will be implemented based on other considerations which themselves have a positive impact on capacity and efficiency and therefore provide an indirect environmental benefit.

2.4.2 No environmental impact is expected with the amendments concerning DLIC, ADS-C, CPDLC and SATVOICE.

2.5 *Efficiency impact:*

2.5.1 The proposal will have a positive efficiency impact as it supports the implementation of the ASBU D-AIM modules and data link and SATVOICE, which enables more flexible use of airspace.

2.6 *Expected implementation time:*

2.6.1 For many States the capability to support the amendments related to AFTN already exists. For those who have identified a need to implement these amendments, the expected implementation time would be prior to November 2018.

2.6.2 For those States to which the amendments related to DLIC, ADS-C and DPDLC are applicable (who have implemented data link and SATVOICE), the expected implementation time would be prior to November 2016.

APPENDIX C

PROPOSED AMENDMENT TO ANNEX 10, VOLUME II

NOTES ON THE PRESENTATION OF THE PROPOSED AMENDMENT

1. The text of the amendment is arranged to show deleted text with a line through it and new text highlighted with grey shading, as shown below:

~~Text to be deleted is shown with a line through it.~~

text to be deleted

New text to be inserted is highlighted with grey shading.

new text to be inserted

~~Text to be deleted is shown with a line through it~~
followed by the replacement text which is highlighted
with grey shading.

new text to replace existing text

2. The sources of the proposed amendments have been indicated as follows:

Source	Annotation
Proposals developed by the Secretariat with the assistance of the Communications Panel (CP)	Source A
Second meeting of the Operational Data Link Panel (OPLINKP)	Source B

TEXT OF PROPOSED AMENDMENT TO
INTERNATIONAL STANDARDS
AND RECOMMENDED PRACTICES
AERONAUTICAL TELECOMMUNICATIONS
ANNEX 10
TO THE CONVENTION ON INTERNATIONAL CIVIL AVIATION
VOLUME II
(COMMUNICATION PROCEDURES INCLUDING THOSE WITH PANS STATUS)

SOURCE B

CHAPTER 1. DEFINITIONS

When the following terms are used in this publication, they have the meaning prescribed in this chapter:

...

1.8 DATA LINK COMMUNICATIONS

...

CPDLC message. Information exchanged between an airborne system and its ground counterpart. A CPDLC message consists of a single message element or a combination of message elements conveyed in a single transmission by the initiator.

CPDLC message set. A list of standard message elements and free text message elements.

...

~~**Downstream data authority.** A designated ground system, different from the current data authority, through which the pilot can contact an appropriate ATC unit for the purposes of receiving a downstream clearance.~~

...

~~**Free text message element.** Part of a message element used to convey information not conforming to that does not conform to any standardized standard message element in the CPDLC message set in the PANS-ATM (Doc 4444).~~

...

Logon address. A specified code used for data link logon to an ATS unit.

~~**Pre-formatted free text message element.** A free text message element that is stored within the aircraft system or ground system for selection.~~

~~**Standardized free text message element.** A message element that uses a defined free text message format, using specific words in a specific order.~~

~~*Note.* Standardized free text message elements may be manually entered by the user or preformatted.~~

Standard message element. Part of a message defined in the PANS-ATM (Doc 4444) in terms of display format, intended use and attributes.

...

SOURCE A

CHAPTER 4. AERONAUTICAL FIXED SERVICE (AFS)

4.1.2 Material permitted in AFS messages

4.1.2.3 For the exchange of messages over the teletypewriter circuits, the following characters of International Alphabet No. 5 (IA-5) shall be permitted:

- characters 0/1 to 0/3, 0/7 — in the priority alarm (*see* 4.4.15.2.2.5), 0/10, 0/11 — in the ending sequence (*see* 4.4.15.3.12.1), 0/13;
- characters 2/0, 2/7 to 2/9, 2/11 to 2/15;
- characters 3/0 to 3/10, 3/13, 3/15;
- characters 4/1 to 4/15;
- characters 5/0 to 5/10; and
- character 7/15.

~~*Note.* The foregoing provisions of 4.1.2.3 are not intended to prevent the use of full IA-5 after agreement between the Administrations concerned.~~

4.1.2.3.1 The exchange of messages using the full IA-5 shall be subject to agreement between the Administrations concerned.

...

4.4.15 Message format – International Alphabet No. 5 (IA-5)

...

4.4.15.3.11 When messages are transmitted only on low-speed circuits, the text of messages entered by the AFTN origin station shall not exceed 1800 characters in length. AFTN messages exceeding 1800 characters shall be entered by the AFTN origin station in the form of separate messages. ~~Guidance material for forming separate messages from a single long message is given in Attachment C to Volume II. When messages or data are transmitted only on medium or high speed circuits the text may be increased to a length that exceeds 1800 characters as long as performance characteristics of the network or link are not diminished and subject to agreement between the Administrations concerned.~~

Note 1.— Low-speed circuits operate at 300 bits per second or less.

Note 2.— Guidance material for forming separate messages from a single long message is given in Attachment C to Volume II.

Note 3.— The character count includes all printing and non-printing characters in the message from, but not including, the start-of-text signal to, but not including, the first alignment function of the ending.

4.4.15.3.11.1 The transmission on medium- or high-speed circuits of AFTN messages with text exceeding 1 800 characters that have not been entered by the AFTN origin station in the form of separate messages shall be subject to agreement between the Administrations concerned and not diminish the performance characteristics of the network or link.

Note 1.— Medium-speed circuits operate at speeds in the range between 300 and 3000 bits per second. High-speed circuits operate at speeds in excess of 3000 bits per second.

Note 2.— Guidance material for forming separate messages from a single long message is given in Attachment B to Volume II.

Note 3.— The character count includes all printing and nonprinting characters in the text from, but not including, the start-of-text signal to, but not including, the first alignment function of the ending.

4.4.15.3.12.1.3 When messages are transmitted only on low-speed circuits, messages entered by the AFTN origin station shall not exceed 2 100 characters in length.

Note 1.— Low-speed circuits operate at 300 bits per second or less.

Note 2.— The character count includes all printing and non-printing characters in the message from and including the start-of-heading character (SOH) to and including the end-of-text character.

4.4.15.3.12.1.4 The transmission on medium- or high-speed circuits of AFTN messages exceeding 2 100 characters that have not been entered by the AFTN origin station in the form of separate messages shall be subject to agreement between the Administrations concerned and not diminish the performance characteristics of the network or link.

Note 1.— Medium-speed circuits operate at speeds in the range between 300 and 3000 bits per second. High-speed circuits operate at speeds in excess of 3000 bits per second.

Note 2.— The character count includes all printing and non-printing characters in the message from and including the start-of-heading character (SOH) to and including the end-of-text character.

4.4.15.4 Except as provided in 4.4.15.5 to 4.4.15.6 and 4.4.16, the procedures of 4.4.8 and 4.4.9 to 4.4.13 shall be used for messages using IA-5 code.

4.4.15.4.1 The transmission of message texts that do not require conversion to the IA-2 code and format and with message lines containing more than 69 printable and non-printable characters shall be subject to agreement between the Administrations concerned.

...

4.6 ATS Message Handling Services (ATSMHS)

The ATS message service of the ATS (air traffic services) message handling service (ATSMHS) application shall be used to exchange ATS messages between users over the aeronautical telecommunication network (ATN) internet.

Note 1.— The ATS message service comprised in the ATS message handling service application aims at providing generic message services over the ATN internet communication service (ICS). It may, in turn, be used as a communication system by user-applications communicating over the ATN. This may be achieved, for example, by means of application programme interfaces to the ATS message service.

Note 2.— The detailed specification of the ATS message handling service application is included in the Manual of Detailed Technical Provisions—Specifications for the Aeronautical Telecommunication Network (ATN) using ISO/OSI Standards and Protocols (Doc 9705), Sub-volume III, (Doc 9880), Part II.

Note 3.— The ATS message service is provided by the implementation over the ATN internet communication service of the message handling systems specified in ISO/IEC (International Organization for Standardization/International Electrotechnical Commission) 10021 and ITU-T (International Telecommunication Union — Telecommunication Standardization Sector) X.400 and complemented by the additional requirements specified in the Manual of Detailed Technical Provisions—Specifications for the Aeronautical Telecommunication Network (ATN) using ISO/OSI Standards and Protocols (Doc 9705) (Doc 9880), Part II. The two sets of documents, the ISO/IEC MOTIS (Message-Oriented Text Interchange System) International Standards and the ITU-T X.400 Series of Recommendations (1988 or later) are, in principle, aligned with each other. However, there are a small number of differences. In the above-mentioned document, reference is made to the relevant ISO International Standards and International Standardized Profiles (ISP), where applicable. Where necessary, e.g. for reasons of interworking or to point out differences, reference is also made to the relevant X.400 Recommendations.

Note 4.— The following types of ATN end systems performing ATS message handling services are defined in the Manual of Detailed Technical Provisions—Specifications for the Aeronautical Telecommunication Network (ATN) using ISO/OSI Standards and Protocols (Doc 9705), Sub-volume III (Doc 9880), Part II.

- 1) an ATS message server;
- 2) an ATS message user agent; and
- 3) an AFTN/AMHS gateway (aeronautical fixed telecommunication network/ATS message handling system); and
- 4) a ~~CIDIN/AMHS gateway (common ICAO data interchange network/ATS message handling system);~~

Connections may be established over the internet communications service between any pair constituted of these ATN end systems (see Table 4-1).

**Table 4-1. Communications between ATN end systems implementing
ATS message handling services**

ATN End System 1	ATN End System 2
ATS Message Server	ATS Message Server
ATS Message Server	AFTN/AMHS Gateway
ATS Message Server	CIDIN/AMHS Gateway
ATS Message Server	ATS Message User Agent
AFTN/AMHS Gateway	AFTN/AMHS Gateway
CIDIN/AMHS Gateway	CIDIN/AMHS Gateway
CIDIN/AMHS Gateway	AFTN/AMHS Gateway

4.7 Inter-Centre Communications (ICC)

The inter-centre communications (ICC) applications set shall be used to exchange ATS messages between air traffic service users over the ATN internet.

Note 1.— The ICC applications set enables the exchange of information in support of the following operational services:

- a) flight notification;
- b) flight coordination;
- c) transfer of control and communications;
- d) flight planning;
- e) airspace management; and
- f) air traffic flow management.

Note 2.— The first of the applications developed for the ICC set is the ATS interfacility data communications (AIDC).

Note 3.— The AIDC application exchanges information between ATS units (ATSUs) for support of critical aircraft control (ATC) functions such as notification of flights approaching a flight information region (FIR) boundary, coordination of boundary conditions and transfer of control and communications authority.

Note 4.— The detailed specification of the AIDC application is included in the Manual of Technical Provisions for the Aeronautical Telecommunication Network (ATN) (Doc 9705), Sub volume III.

Note 5.— The AIDC application is strictly an ATC application for exchanging tactical control information between ATS units. It does not support the exchange of information with other offices or facilities.

Note 6.— The AIDC application supports the following operational services:

- a) flight notification;*
- b) flight coordination;*
- c) transfer of executive control;*
- d) transfer of communications; and*
- e) transfer of general information (flight related data or free text messages, i.e. unstructured).*

SOURCE B

CHAPTER 5. AERONAUTICAL MOBILE SERVICE — VOICE COMMUNICATIONS

5.1 General

Note 1.— For the purposes of these provisions, the communication procedures applicable to the aeronautical mobile service, as appropriate, also apply to the aeronautical mobile satellite service.

Note 2.— Guidance material for the implementation of the aeronautical mobile satellite service is contained in the Manual on the Aeronautical Mobile Satellite (Route) Service (Doc 9925). Additional guidance for SATVOICE communication systems is contained in the Satellite Voice Operations Manual (Doc 10038) and the Performance-based Communication and Surveillance (PBCS) Manual (Doc 9869).

5.2 Radiotelephony procedures

5.2.1.5 *Transmitting technique*

...

5.2.1.5.8 The following words and phrases shall be used in radiotelephony communications as appropriate and shall have the meaning ascribed hereunder:

...

<i>Phrase</i>	<i>Meaning</i>
---------------	----------------

...

OVER	“My transmission is ended, and I expect a response from you.”
------	---

Note.— *Not normally used in VHF or SATVOICE communications.*

OUT	“This exchange of transmissions is ended and no response is expected.”
-----	--

Note.— *Not normally used in VHF or SATVOICE communications.*

...

CHAPTER 8. AERONAUTICAL MOBILE SERVICE — DATA LINK COMMUNICATIONS

8.1 GENERAL

...

Note 3. — *Guidance material relating to CPDLC, ADS-C, and related data link initiation capability (DLIC), can be found in the Global Operational Data Link (GOLD) Manual (Doc 10037).*

...

Insert new text as follows:

8.1.1 Data link initiation capability (DLIC)

8.1.1.1 General

8.1.1.1.1 **PANS.**— *Before entering an airspace where data link applications are used by the ATS unit, data link communications shall be initiated between the aircraft and the ATS unit in order to register the aircraft and, when necessary, allow the start of a data link application. This shall be initiated by the aircraft, either automatically or by the pilot, or by the ATS unit on address forwarding.*

Note.— *Guidance material relating to the data link initiation capability (DLIC) can be found in the Global Operational Data Link (GOLD) Manual (Doc 10037).*

8.1.1.1.2 **PANS.**— *The logon address associated with an ATS unit shall be published in Aeronautical Information Publications in accordance with Annex 15.*

Note.— *A given FIR may have multiple logon addresses; and more than one FIR may share the same logon address.*

8.1.1.2 Aircraft initiation

PANS.— *On receipt of a valid data link initiation request from an aircraft approaching or within a data link service area, the ATS unit shall accept the request and, if able to correlate it with a flight plan, shall establish a connection with the aircraft.*

8.1.1.3 ATS unit forwarding

PANS.— *The ground system initially contacted by the aircraft shall provide to the next ATS unit any relevant updated aircraft information in sufficient time to permit the establishment of data link communications.*

8.1.1.4 Failure

8.1.1.4.1 **PANS.**— *In the case of a data link initiation failure, the data link system shall provide an indication of the failure to the appropriate ATS unit(s). The data link system shall also provide an indication of the failure to the flight crew when a data link initiation failure results from a logon initiated by the flight crew.*

Note.— *When the aircraft's logon request results from responding to a contract request by a transferring ATS unit, then both ATS units will receive the indication.*

8.1.1.4.2 **PANS.**— *The ATS unit shall establish procedures to resolve, as soon as practicable, data link initiation failures. Procedures shall include, as a minimum, verifying that the aircraft is initiating a data link request with the appropriate ATS unit (i.e. the aircraft is approaching or within the ATS unit's control area); and if so:*

- a) *when a flight plan is available, verify that the aircraft identification, aircraft registration, or aircraft address and other details contained in the data link initiation request correspond with details in the flight plan, and where differences are detected verify the correct information and then make the necessary changes; or*
- b) *when a flight plan is not available, create a flight plan with sufficient information in the flight data processing system, to achieve a successful data link initiation; then*
- c) *arrange for the re-initiation of the data link.*

8.1.1.4.3 **PANS.**— *The aircraft operator shall establish procedures to resolve, as soon as practicable, data link initiation failures. Procedures shall include, as a minimum, that the pilot:*

- a) *verify the correctness and consistency of the flight plan information available in the FMS or equipment from which data link is initiated, and where differences are detected make the necessary changes; and*
- b) *verify the correct address of the ATS unit; then*
- c) *re-initiate data link.*

End of new text.

Editorial Note.— Renumber subsequent paragraphs

...

SOURCE B

8.2 CPDLC PROCEDURES

...

8.2.6 The pilot and the controller shall be provided with the capability to exchange messages which do not conform to defined formats (i.e. free text messages) include standard message elements, free text message elements or a combination of both.

...

8.2.9 Exchange of operational CPDLC messages

8.2.9.1 Controllers and pilots shall construct CPDLC messages using ~~the defined message set, a free text message~~ standard message elements, free text message elements or a combination of both.

8.2.9.1.1 **PANS.**— When CPDLC is being used, and the intent of the message is included in the CPDLC message set contained in the PANS-ATM, Appendix 5, the associated ~~message-standard message elements~~ shall be used.

...

8.2.9.3 CPDLC ground systems and airborne systems shall be capable of using the CPDLC message ~~urgency and alert attributes to alter presentations~~ in order to draw attention to higher priority messages.

Note.— Message attributes dictate certain message handling requirements for the CPDLC user receiving a message. Each CPDLC message has ~~three~~ ~~two~~ attributes: ~~urgency~~, alert and response attributes. When a message contains multiple message elements, the highest precedence message element attribute type becomes the attribute type for the entire message.

~~8.2.9.3.1~~ The urgency attribute shall delineate the queuing requirements for received messages that are displayed to the end user. Urgency types are presented in Table 8-1.

8.2.9.3.2~~1~~ The alert attribute shall delineate the type of alerting required upon message receipt. Alert types are presented in Table 8-2~~1~~.

8.2.9.3.3~~2~~ The response attribute shall delineate valid responses for a given message element. Response types are presented in Table 8-3~~2~~ for uplink messages and Table 8-4~~3~~ for downlink messages.

Table 8-1. Urgency Attribute (Uplink and Downlink)

<i>Type</i>	<i>Description</i>	<i>Precedence</i>
Ⓓ	Distress	1
⒰	Urgent	2
⒩	Normal	3
Ⓕ	Low	4

Table 8-2~~1~~. Alert Attribute (Uplink and Downlink)

...

Table 8-3~~2~~. Response Attribute (Uplink)

...

Table 8-43. Response Attribute (Downlink)

<i>Type</i>	<i>Response required</i>	<i>Valid responses</i>	<i>Precedence</i>
Y	Yes	Any CPDLC uplink message, LOGICAL ACKNOWLEDGEMENT (only if required)	1
N	No, unless logical acknowledgement required	LOGICAL ACKNOWLEDGEMENT (only if required), SERVICE UNAVAILABLE MESSAGE NOT SUPPORTED BY THIS ATC UNIT, FLIGHT PLAN NOT HELD, ERROR	2

8.2.9.3.3.1 **PANS.**— *When a multi-element message requires a response, and the response is in the form of a single message element, the response shall apply to all message elements.*

Note.— *For example, a multi-element message containing CLIMB TO FL310 MAINTAIN MACH.84, a WILCO response applies to, and indicates compliance with, both elements of the message.*

...

8.2.9.5 The appropriate ATS authority shall select those message elements contained in PANS-ATM, Appendix 5 that support operations in their airspace. Should an ATS authority choose to select a subset of the message elements, and a received message does not belong to this subset, the ATC unit shall respond by uplinking the message element ~~SERVICE UNAVAILABLE MESSAGE NOT SUPPORTED BY THIS ATC UNIT.~~

...

~~8.2.9.5.2 When considered necessary by the appropriate ATS authority, additional standardized free text message elements shall be made available and used by controllers and pilots for those occasions where the CPDLC message set contained in the PANS-ATM does not provide for specific requirements. In such cases, a list of standardized free text message elements shall be established by the appropriate ATS authority, in consultation with operators and other ATS authorities that may be concerned.~~

8.2.9.5.3 Information concerning CPDLC message elements subset utilized and, if applicable, any additional standardized free text message elements shall be published in the ~~a~~ **Aeronautical Information Publications (AIPs).**

~~8.2.9.5.4 **PANS.**— Standardized free text message elements should be pre formatted to facilitate their use.~~

...

8.2.11 Free text messages- elements

8.2.11.1 PANS.— *The use of free text message elements by controllers or pilots, ~~other than standardized free text message elements referred to in paragraph 8.2.9.5.2,~~ should be avoided.*

Note.— *Whilst it is recognized that non-routine and emergency situations may necessitate the use of free text, particularly when voice communication has failed, the avoidance of utilizing free text messages is intended to reduce the possibility of misinterpretation and ambiguity.*

8.2.11.2 When the CPDLC message set contained in the PANS-ATM (Doc 4444) does not provide for specific circumstances, the appropriate ATS authority may determine that it is acceptable to use free text message elements. In such cases, the appropriate ATS authority, in consultation with operators and other ATS authorities that may be concerned, shall define display format, intended use and attributes for each free text message element and publish them with relevant procedures in the AIPs.

8.2.11.3 PANS.— *Free text message elements should be stored for selection within the aircraft or ground system to facilitate their use.*

...

8.2.12 Emergencies, hazards and equipment failure procedures

...

8.2.12.2 PANS.— *When responding via CPDLC to a report indicating unlawful interference, uplink message ~~ROGER 7500 shall be used.~~*

...

8.2.12.5 FAILURE OF CPDLC

Note 1.— *Action to be taken in the event of a ~~CPDLC data link initiation~~ failure is covered in ~~8.2.12.6~~ 8.1.1.4.*

Note 2.— *Action to be taken in the event of the failure of a single CPDLC message is covered in 8.2.12.87.*

...

Editorial Note.— *Delete section 8.2.12.6 and renumber subsequent paragraphs*

...

Editorial Note.— *Delete section 8.2.14*

APPENDIX D

**AMENDMENT 90 TO THE INTERNATIONAL STANDARDS
AND RECOMMENDED PRACTICES**

**ANNEX 10— AERONAUTICAL TELECOMMUNICATIONS,
VOLUME II — COMMUNICATION PROCEDURES INCLUDING THOSE WITH PANS STATUS**

RESOLUTION OF ADOPTION

The Council

Acting in accordance with the Convention on International Civil Aviation, and particularly with the provisions of Articles 37, 54 and 90 thereof,

1. *Hereby adopts* on [D] Amendment 90 to the International Standards and Recommended Practices contained in the document entitled *Aeronautical Telecommunications — Communication Procedures including those with PANS status* which for convenience is designated Annex 10, Volume II to the Convention;

2. *Prescribes* [*] July 2016 as the date upon which the said amendment shall become effective, except for any part thereof in respect of which a majority of the Contracting States have registered their disapproval with the Council before that date;

3. *Resolves* that the said amendment or such parts thereof as have become effective shall become applicable on 10 November 2016;

4. *Requests the Secretary General:*

- a) to notify each Contracting State immediately of the above action and immediately after [*] July 2016 of those parts of the amendment which have become effective;
- b) to request each Contracting State:
 - 1) to notify the Organization (in accordance with the obligation imposed by Article 38 of the Convention) of the differences that will exist on 10 November 2016 between its national regulations or practices and the provisions of the Standards in the Annex as hereby amended, such notification to be made before 10 October 2016, and thereafter to notify the Organization of any further differences that arise;
 - 2) to notify the Organization before 10 October 2016 of the date or dates by which it will have complied with the provisions of the Standards in the Annex as hereby amended;
- c) to invite each Contracting State to notify additionally any differences between its own practices and those established by the Recommended Practices, when the notification of such differences is important for the safety of air navigation, following the procedure specified in subparagraph b) above with respect to differences from Standards.

APPENDIX E

AMENDMENT TO THE FOREWORD OF ANNEX 10, VOLUME II
 (Sixth Edition)

Add the following at the end of Table A:

<i>Amendment</i>	<i>Source(s)</i>	<i>Subject</i>	<i>Adopted/Approved Effective Applicable</i>
90	Communications Panel (CP); the Secretariat Second meeting of the Operational Data Link Panel (OPLINKP/2)	a) aeronautical fixed telecommunication network (AFTN) and new message types; b) data link initiation capability (DLIC); c) automatic dependent surveillance — contract (ADS-C); d) controller-pilot data link communications (CPDLC); and e) satellite voice communications (SATVOICE).	D * 10 November 2016



International Civil Aviation Organization

WORKING PAPER

C-WP/xxxxx
ANC Report
.././16

COUNCIL — 207TH SESSION

Subject No. 14.1.1: International Standards and Recommended Practices (SARPs)

ADOPTION OF AMENDMENT 90 TO ANNEX 10, VOLUME III

(Presented by the President of the Air Navigation Commission)

EXECUTIVE SUMMARY

This paper presents a proposal of the Air Navigation Commission for Amendment 90 to Annex 10 — *Aeronautical Telecommunications, Volume III — Communication Systems*. The amendment proposal concerns the aeronautical mobile airport communications system (AeroMACS) and satellite voice communications (SATVOICE).

Having examined the technical circumstances associated with the implementation of the amendment, the Air Navigation Commission considers that an effective date of July 2016 and a proposed applicability date of 10 November 2016 would be suitable for the implementation of these provisions.

Action: The Commission recommends that the Council:

- a) adopt, as Amendment 90 to Annex 10, Volume III, the amendments to definitions and to Standards and Recommended Practices as contained in Appendix C to this paper;
- b) approve, as part of the said amendment, the amendment to Notes and attachments as contained in Appendix C to this paper;
- c) approve the Resolution of Adoption in Appendix D to this paper; and
- d) approve, as part of the said amendment, the amendment to the Foreword of Annex 10, Volume III as contained in Appendix E to this paper.

<i>Strategic Objectives:</i>	This working paper relates to the Safety, Environmental Protection and Sustainable Development of Air Transport Strategic Objectives.
<i>Financial implications:</i>	Minimal cost to States; moderate cost to industry.
<i>References:</i>	AN-WP/9038 AN Min. 201-xx *Annex 10, Volume III, Parts I and II For all other references, please refer to paragraph 2.

1. INTRODUCTION

1.1 This report deals with a proposal of the Air Navigation Commission for the amendment of Annex 10 — *Aeronautical Telecommunications*, Volume III — *Communication Systems* arising from the following sources:

- a) proposal developed by the Secretariat with the assistance of the Communications Panel (CP) relating to the aeronautical mobile airport communications system (AeroMACS); and
- b) a recommendation of the second meeting of the Operational Data Link Panel (OPLINKP/2) relating to satellite voice communications (SATVOICE).

1.2 On [D] 2016, the Commission (201-xx) reviewed AN-WP/9038 containing the draft report to Council on the adoption of Amendment 90 to Annex 10, Volume III and approved the report.

2. BACKGROUND

2.1 The development and review of the proposed amendment has followed the established process, as shown in the table below:

Amendment concerning	Preliminary review by ANC and WP no.	State letter and date	Final review by the ANC and WP no.	No. of replies at final review ¹
Aeronautical mobile airport communications system (AeroMACS)	3 March 2015 (ANC 198-6) AN-WP/8904 and Discussion Paper No. 1	AN 7/1.3.100-15/29 4 May 2015	7 October 2015 (ANC 200-6) AN-WP/8975, Addendum/Corrigendum No. 1 and Discussion Paper No. 1	58 Member States (21) 3 int. orgs Total: 61 replies
Satellite voice communications (SATVOICE)	14 May 2015 (ANC 199-5) AN-WP/8928.PDP	SP 52/4-15/44 ² 12 June 2015 and Corrigendum dated 15 July 2015	10 November 2015 (ANC 200-10) AN-WP/8967 Addendum No. 1 revised and Discussion Paper No. 1	59 Member States (23) 5 int. orgs. Total: 64 replies

¹ Number in parenthesis is the number of Council Member States who have replied.

² Proposal also includes amendments to Annex 6, Parts II and III; Annex 11; Annex 15; PANS-ATM (Doc 4444); and the *Procedures for Air Navigation Services — ICAO Abbreviations and Codes* (PANS-ABC, Doc 8400).

2.2 The Commission has agreed that the amendments listed in the table above be presented to the Council for inclusion in Amendment 90 to Annex 10, Volume III and thus recommends to the Council to take action as stated in the executive summary.

3. RATIONALE, IMPLEMENTATION ISSUES AND COST IMPACT

3.1 Amendment concerning aeronautical mobile airport communications system (AeroMACS)

Rationale

3.1.1 The AeroMACS provisions fulfil the need for a broadband communication system on the airport surface to support future air traffic management services by utilizing 5091 MHz to 5150 MHz spectrum allocated by WRC-07 and the need for AM(R)S services.

Implementation issues

3.1.2 As this technology is “off-the-shelf”, technical support would typically be provided by the vendor. While some States with advanced ATM plans have already identified this technology as a necessary future enabler, other States may benefit from understanding the role that AeroMACS will play among the choices of datalink technology available. Hence, AeroMACS should be a component of any future workshops/seminars, etc. on aeronautical datalink technology. This would ensure the timely and appropriate implementation of this enabling technology. An implementation task list is presented in Appendix A.

Cost impact

3.1.3 AeroMACS will require new ground infrastructure which can be owned and operated by the States or procured as a service. Whether procured as a service or owned outright, the operating costs will be offset by savings derived from efficiency gains brought about by the applications that it uniquely supports. Aircraft will require additional avionics equipment for AeroMACS; this cost would also be offset by the savings derived from the expected efficiency gains. An impact assessment is presented in Appendix B.

3.2 Amendment concerning satellite voice communications (SATVOICE)

Rationale

3.2.1 The proposed amendment is to standardize SATVOICE system characteristics essential for common infrastructure using different satellite companies, network service providers and aircraft equipment. The provisions will prevent further divergence in implementation and contribute positively to a transition from high frequency (HF) voice to SATVOICE as envisioned in the *Global Air Navigation Plan* (Doc 9750).

Implementation issues

3.2.2 No significant implementation issues are expected in relation to the proposed changes to Annex 10, Volume III. SATVOICE is not a mandatory means of communication and complements existing high frequency (HF) voice services. Air navigation service providers of some States are already providing or are planning to provide SATVOICE services in situations such as poor HF propagation conditions and emergencies. Major aircraft manufacturers and satellite services providers have been supporting the SATVOICE capabilities in the proposed amendment for many years and the major States of manufacture have included such capabilities as part of their aircraft certification policies.

Cost impact

3.2.3 For air navigation service providers and operators that decide to implement SATVOICE, major costs will stem from the need to: a) upgrade communication systems on board aircraft and in ATS units; b) subscribe to SATVOICE services; and c) support monitoring programmes. Cost impact for States will be limited to rulemaking, the modification of approval processes and the training of inspectors. These costs will vary depending on requirements and the current status of implementation.

4. EFFECTIVE AND APPLICABILITY DATES

4.1 The Air Navigation Commission, having examined the technical circumstances associated with the implementation of the amendment, considers that an effective date of July 2016 and a proposed applicability date of 10 November 2016 for the amendment would be suitable for the implementation of these provisions.

Farid Zizi

APPENDIX A

IMPLEMENTATION TASK LIST AND OUTLINE OF GUIDANCE MATERIAL IN RELATION TO AMENDMENT 90 TO ANNEX 10, VOLUME III

1. IMPLEMENTATION TASK LIST

Aeronautical mobile airport communications system (AeroMACS)

1.1 Essential steps to be followed by a State in order to implement the proposed amendment to Annex 10, Volume III:

- a) Identification of one of the following rationales for AeroMACS implementation:
 - Congestion on air-ground datalink frequencies at aerodromes.
 - The need for point-to-point data communication at aerodrome related to the safety and regularity of flight that, cannot be economically be achieved through the use of cabling.
 - The need to support numerous future, surface air-ground datalink applications related to the regularity and safety of flight, i.e. update of map data for aircraft moving map displays, update of electronic flight bags and access to digital NOTAMS, which cannot be supported by current datalink technologies.
- b) performance of site survey as described in Doc 10044, *Manual on the Aeronautical Mobile Airport Communication System (AeroMACS)* to determine siting and equipage requirements;
- c) identification of the rule-making process necessary to transpose the amendments into the national regulation taking into consideration the applicability dates;
- d) identification and notification of differences, if applicable;
- e) drafting of the modification(s) to the national requirements and means of compliance;
- f) official adoption of the national requirements and/or means of compliance;
- g) revision of guidance material and checklists for applicable inspectors (flight operations, airworthiness);
- h) training of inspectors based on the revised inspector guidance material;

- i) development of an implementation plan, including timelines, to confirm compliance for each applicable air operator and air navigation service providers;
- j) approval of the installation of new equipment or upgrade of existing equipment, to comply with applicable requirements, if requested by air operators and air navigation services providers (ANSPs); and
- k) operational acceptance of policy and procedures of ANSPs and operator(s) to comply with applicable requirements.

Satellite voice communications (SATVOICE)

1.2 Essential steps to be followed by a State in order to implement the proposed amendment to Annex 10, Volume III.

- a) identification of the need for the use of SATVOICE for air traffic services (ATS) to complement HF voice communications;
- b) identification of the rule-making process necessary to transpose the amendments into the national regulation taking into consideration the applicability dates;
- c) identification and notification of differences, if applicable;
- d) drafting of the modification(s) to the national requirements and means of compliance;
- e) official adoption of the national requirements and/or means of compliance;
- f) modification of surveillance programmes to include new requirements, if applicable;
- g) revision of guidance material and checklists for applicable inspectors (flight operation, airworthiness and air navigation service providers (ANSPs));
- h) training of inspectors based on the revised inspector guidance material;
- i) development of an implementation plan, including timelines, to confirm compliance for each applicable air operator and air navigation service providers;
- j) approval of the installation of new equipment or upgrade of existing equipment, to comply with applicable requirements, if requested by air operators and ANSP(s); and
- k) operational acceptance of policy and procedures of ANSP(s) and operator(s) to comply with applicable requirements.

2. STANDARDIZATION PROCESS

- 2.1 Effective date: [D] July 2016
- 2.2 Applicability date: 10 November 2016
- 2.3 Embedded applicability date(s): N/A

3. SUPPORTING DOCUMENTATION**3.1 ICAO documentation**

Title	Type (PANS/TI/Manual/Circ)	Planned publication date
<i>Manual on the Aeronautical Mobile Airport Communication System (AeroMACS)</i> (Doc 10044)	Manual	Third quarter 2016
<i>Satellite Voice Operations Manual (SVOM)</i> (Doc 10038)	Manual	Third quarter 2016

3.2 External documentation

Title	External Organization	Publication date
Nil.		

4. IMPLEMENTATION ASSISTANCE TASKS

Type	Global	Regional
Workshops		Yes

5. UNIVERSAL SAFETY OVERSIGHT AUDIT PROGRAMME (USOAP)

- 5.1 No additional USOAP CMA protocol questions or modifications to existing questions are proposed.

APPENDIX B

IMPACT ASSESSMENT IN RELATION TO AMENDMENT 90 TO ANNEX 10, VOLUME III

1. INTRODUCTION

1.1 The ICAO Global Air Navigation Plan (GANP) identifies a need for broadband communication system on the airport surface to support future air traffic management (ATM) services. The proposed AeroMACS Standards and Recommended Practices (SARPs) fulfil that identified need by utilizing 5091 MHz to 5150 MHz spectrum allocated by WRC-07 for AM(R)S services.

1.2 The proposal relating to SATVOICE is intended to standardize SATVOICE system characteristics essential for common infrastructure using different satellite companies, network service providers and aircraft equipment.

2. IMPACT ASSESSMENT

2.1 *Safety impact:*

2.1.1 The proposed AeroMACS system will have a positive safety impact as it will improve situational awareness for both controllers and pilots facilitating improvements in conflict resolution and hazard avoidance.

2.1.2 Implementation of the proposal relating to SATVOICE will have a positive safety impact as the provisions are intended to ensure that the SATVOICE systems have capabilities to allow controllers and pilots to contact each other in a secure and safe way.

2.2 *Financial impact:*

2.2.1 AeroMACS will require new ground infrastructure, which can be owned and operated by the States or procured as service. Whether procured as service or owned outright, the operating costs will be offset by savings derived from efficiency gains brought about by the applications that it uniquely supports. Aircraft will require additional avionics equipment for AeroMACS; however, this cost would also be offset by the savings from the expected efficiency gains.

2.2.2 The financial impact to States for the proposal relating to SATVOICE is the cost of incorporating the SATVOICE system requirements into their national regulations and including such requirements into the safety oversight activities. The financial impact to industry will vary depending on the current implementation status of SATVOICE and communication monitoring programmes.

2.3 *Security impact:*

2.3.1 AeroMACS utilizes public key infrastructure (PKI)-based encryption and authentication to protect operational and business data from unauthorized access.

2.3.2 The proposal relating to SATVOICE will have a positive security impact as it provides a secure calling capability and priority and will contribute to the prevention of unauthorized air-ground calls.

2.4 *Environmental impact:*

2.4.1 The applications supported by AeroMACS will reduce hold over, taxi, and weather-related delays through utilization of better and more timely information. This will result in an overall reduction of the noise and carbon footprints of aircraft operations.

2.4.2 No environmental impact is expected with the proposal relating to SATVOICE.

2.5 *Efficiency impact:*

2.5.1 AeroMACS will enable airport automation, improve situational awareness of pilots and controllers and permit better flight planning, reducing delays, holding times, fuel burn and carbon emissions. It will also offload most of the strategic ATM and FIS communications from VDL Mode 2, thereby preserving limited VDL M2 spectrum for tactical communications.

2.5.2 The proposal relating to SATVOICE will have a positive efficiency impact as it provides more efficient air-ground communications, which will enable more flexible use of airspace.

2.6 *Expected implementation time:*

2.6.1 The expected implementation time is two to five years for AeroMACS and one year for SATVOICE. It should be appreciated that not all aerodromes and airspace will have a need to implement AeroMACS and SATVOICE.

APPENDIX C

PROPOSED AMENDMENT TO ANNEX 10, VOLUME III

NOTES ON THE PRESENTATION OF THE AMENDMENT

1. The text of the amendment is arranged to show deleted text with a line through it and new text highlighted with grey shading, as shown below:

~~Text to be deleted is shown with a line through it.~~

text to be deleted

New text to be inserted is highlighted with grey shading.

new text to be inserted

~~Text to be deleted is shown with a line through it~~ followed by the replacement text which is highlighted with grey shading.

new text to replace existing text

2. The sources of the proposed amendments have been indicated as follows:

Source	Annotation
Proposals developed by the Secretariat with the assistance of the Communications Panel (CP)	Source A
Second meeting of the Operational Data Link Panel (OPLINKP/2)	Source B

PROPOSED AMENDMENT TO
INTERNATIONAL STANDARDS
AND RECOMMENDED PRACTICES
AERONAUTICAL TELECOMMUNICATIONS
ANNEX 10
TO THE CONVENTION ON INTERNATIONAL CIVIL AVIATION
VOLUME III
COMMUNICATION SYSTEMS
PART I — DIGITAL DATA COMMUNICATION SYSTEMS

Source A

TABLE OF CONTENTS

CHAPTER 7. ~~Subnetwork Interconnection~~ Aeronautical Mobile Airport Communications System (AeroMACS)..... I-7-x
~~(to be developed)~~

7.1	Definitions	I-7-x
7.2	Introduction	I-7-x
7.3	General	I-7-x
7.4	Radio frequency (RF) characteristics	I-7-x
7.5	Performance requirements	I-7-x
7.6	System interfaces	I-7-x
7.7	Application requirements	I-7-x

...

CHAPTER 7. ~~SUBNETWORK INTERCONNECTION~~ AERONAUTICAL MOBILE AIRPORT COMMUNICATIONS SYSTEM (AEROMACS)

~~(to be developed)~~

Insert new text as follows

7.1 DEFINITIONS

Adaptive modulation. A system's ability to communicate with another system using multiple burst profiles and a system's ability to subsequently communicate with multiple systems using different burst profiles.

Aerodrome. A defined area on land or water (including any buildings, installations and equipment) intended to be used either wholly or in part for the arrival, departure and surface movement of aircraft.

Aeronautical Mobile Airport Communications System (AeroMACS). A high capacity data link supporting mobile and fixed communications on the aerodrome surface.

AeroMACS downlink (DL). The transmission direction from the base station (BS) to the mobile station (MS).

AeroMACS uplink (UL). The transmission direction from the mobile station (MS) to the base station (BS).

AeroMACS handover. The process in which a mobile station (MS) migrates from the air-interface provided by one base station (BS) to the air-interface provided by another BS. A break-before-make AeroMACS handover is where service with the target BS starts after a disconnection of service with the previous serving BS.

Base station (BS). A generalized equipment set providing connectivity, management, and control of the mobile station (MS).

Bit error rate (BER). The number of bit errors in a sample divided by the total number of bits in the sample, generally averaged over many such samples.

Burst profile. Set of parameters that describe the uplink or downlink transmission properties associated with an interval usage code. Each profile contains parameters such as modulation type, forward error correction (FEC) type, preamble length, guard times, etc.

Convolutional turbo codes (CTC). Type of forward error correction (FEC) code.

Data transit delay. In accordance with ISO 8348, the average value of the statistical distribution of data delays. This delay represents the subnetwork delay and does not include the connection establishment delay.

Domain. A set of end systems and intermediate systems that operate according to the same routing procedures and that is wholly contained within a single administrative domain.

Forward error correction. The process of adding redundant information to the transmitted signal in a manner which allows correction, at the receiver, of errors incurred in the transmission.

Frequency assignment. A logical assignment of centre frequency and channel bandwidth programmed to the base station (BS).

Mobile station (MS). A station in the mobile service intended to be used while in motion or during halts at unspecified points. An MS is always a subscriber station (SS).

Partial usage sub-channelization (PUSC). A technique in which the orthogonal frequency division multiplexing (OFDM) symbol subcarriers are divided and permuted among a subset of sub-channels for transmission, providing partial frequency diversity.

Residual error rate. The ratio of incorrect, lost and duplicate subnetwork service data units (SNSDUs) to the total number of SNSDUs that were sent.

Service data unit (SDU). A unit of data transferred between adjacent layer entities, which is encapsulated within a protocol data unit (PDU) for transfer to a peer layer.

Service flow. A unidirectional flow of media access control layer (MAC) service data units (SDUs) on a connection that is providing a particular quality of service (QoS).

Subscriber station (SS). A generalized equipment set providing connectivity between subscriber equipment and a base station (BS).

Subnetwork entry time. The time from when the mobile station starts the scanning for BS transmission, until the network link establishes the connection, and the first network user “protocol data unit” can be sent.

Subnetwork service data unit (SNSDU). An amount of subnetwork user data, the identity of which is preserved from one end of a subnetwork connection to the other.

Time division duplex (TDD). A duplex scheme where uplink and downlink transmissions occur at different times but may share the same frequency.

...

7.2 INTRODUCTION

Note 1.— Aeronautical mobile airport communications system (AeroMACS) is a high capacity data link supporting mobile and fixed communications, related to the safety and regularity of flight, on the aerodrome surface.

Note 2.— AeroMACS is derived from the IEEE 802.16-2009 mobile standards. AeroMACS profile document (RTCA DO345 and EUROCAE ED 222) lists all features from these standards which are mandatory, not applicable or optional. AeroMACS profile differentiates between base station and mobile station functionality and contains, for each feature, a reference to the applicable standards.

7.3 GENERAL

- 7.3.1 AeroMACS shall conform to the requirements of this and the following chapters.
- 7.3.2 AeroMACS shall only transmit when on the surface of an aerodrome.
- 7.3.3 AeroMACS shall support aeronautical mobile (route) service (AM(R) S) communications.
- 7.3.4 AeroMACS shall process messages according to their associated priority.
- 7.3.5 AeroMACS shall support multiple levels of message priority.
- 7.3.6 AeroMACS shall support point to point communication.
- 7.3.7 AeroMACS shall support multicast and broadcast communication services.
- 7.3.8 AeroMACS shall support internet protocol (IP) packet data services.
- 7.3.9 AeroMACS shall provide mechanisms to transport ATN/IPS and ATN/OSI (over IP) based messaging.
- 7.3.10 **Recommendation.**— *AeroMACS should support voice services.*
- Note.*— Manual on the Aeronautical Telecommunication Network (ATN) using Internet Protocol Suite (IPS) Standards and Protocols (*Doc 9896*) provides information on voice service over IP .
- 7.3.11 AeroMACS shall support multiple service flows simultaneously.
- 7.3.12 AeroMACS shall support adaptive modulation and coding.
- 7.3.13 AeroMACS shall support handover between different AeroMACS BSs during aircraft movement or on degradation of connection with current BS.
- 7.3.14 AeroMACS shall keep total accumulated interference levels with limits defined by the International Telecommunication Union — Radiocommunication Sector (ITU-R) as required by national/international rules on frequency assignment planning and implementation.
- 7.3.15 AeroMACS shall support a flexible implementation architecture to permit link and network layer functions to be located in different or same physical entities.

7.4 RADIO FREQUENCY (RF) CHARACTERISTICS

7.4.1 General Radio Characteristics

- 7.4.1.1 AeroMACS shall operate in time division duplex (TDD) mode.
- 7.4.1.2 AeroMACS shall operate with a 5 MHz channel bandwidth.
- 7.4.1.3 AeroMACS MS antenna polarization shall be vertical.
- 7.4.1.4 AeroMACS BS antenna polarization shall have a vertical component.
- 7.4.1.5 AeroMACS shall operate without guard bands between adjacent AeroMACS channels.
- 7.4.1.6 AeroMACS shall operate according to the orthogonal frequency division multiple access method.
- 7.4.1.7 AeroMACS shall support both segmented partial usage sub-channelization (PUSC) and PUSC with all carriers as sub-carrier permutation methods.

7.4.2 Frequency bands

7.4.2.1 AeroMACS equipment shall operate in the band from 5 030 MHz to 5 150 MHz in channels of 5 MHz bandwidth.

Note 1.— Some States may, on the basis of national regulations, have additional allocations to support AeroMACS. Information on the technical characteristics and operational performance of AeroMACS is contained in the AeroMACS Minimum Operational Performance Specification (MOPS) (EUROCAE ED-223 / RTCA DO-346) and AeroMACS Minimum Aviation System Performance Standard (MASPS) (EUROCAE ED-227).

Note 2.— The last centre frequency of 5 145 MHz is selected as the reference frequency for the numbering of AeroMACS channels. AeroMACS nominal centre frequencies are numbered downward from the reference frequency in 5 MHz steps.

7.4.2.2 The mobile equipment shall operate at centre frequencies offset from the preferred frequencies, with an offset of 250 kHz step size.

Note.— The nominal centre frequencies are the preferred centre frequencies for AeroMACS operations. However, the base stations should have the capability to deviate from the preferred centre frequencies to satisfy potential national spectrum authority implementation issues (i.e. to allow AeroMACS operations without receiving or causing interference to other systems operating in the band such as MLS and AMT).

7.4.3 Radiated power

7.4.3.1 The maximum mobile station equivalent isotropic radiated power (EIRP) shall not exceed 30 dBm.

7.4.3.2 The maximum base station EIRP in a sector shall not exceed 39.4 dBm.

7.4.3.3 **Recommendation.**— *In order to meet ITU requirements, the total base station EIRP in a sector should be decreased from that peak, considering the antenna characteristics, at elevations above the horizon. Further information is provided in the guidance material.*

Note 1.— EIRP defined as antenna gain in a specified elevation direction plus the average AeroMACS transmitter power. While the instantaneous peak power from a given transmitter may exceed that level when all of the subcarriers randomly align in phase, when the large number of transmitters assumed in the analysis is taken into account, average power is the appropriate metric.

Note 2.— If a sector contains multiple transmit antennas (e.g., multiple input multiple output (MIMO) antenna), the specified power limit is the sum of the powers from each antenna.

7.4.4 Minimum receiver sensitivity

7.4.4.1 AeroMACS receiver sensitivity shall comply with Table 7-1, AeroMACS receiver sensitivity values.

Note 1.— The computation of the sensitivity level for AeroMACS is described in the Aeronautical Mobile Airport Communications System(AeroMACS) Manual (Doc 10044).

Note 2.— AeroMACS receiver would be 2 dB more sensitive than indicated if Convolutional Turbo Codes (CTC) is used.

Note 3.— The sensitivity level is defined as the power level measured at the receiver input when the bit error rate (BER) is equal to 1×10^{-6} and all active sub-carriers are transmitted in the channel. In general the requisite input power depends on the number of active sub-carriers of the transmission.

Note 4.— The values in Table 7-1 assume a receiver noise figure of 8 dB.

Note 5.— The sensitivity values in Table 7-1 assume absence of any source of interference except for thermal and receiver noise.

Table 7-1. AeroMACS receiver sensitivity values

Modulation scheme using convolutional codes (CC) encoding scheme	Rep. Factor	MS Sensitivity	BS Sensitivity
64 QAM 3/4	1	-74.3 dBm	-74.5 dBm
64 QAM 2/3	1	-76.3 dBm	-76.5 dBm
16 QAM 3/4	1	-80.3 dBm	-80.5 dBm
16 QAM 1/2	1	-83.8 dBm	-84.0 dBm
QPSK 3/4	1	-86.3 dBm	-86.5 dBm
QPSK 1/2	1	-89.3 dBm	-89.5 dBm
QPSK 1/2 with repetition 2	2	-92.3 dBm	-92.5 dBm

Note .— A 64 QAM transmission is optional for MS.

7.4.5 Spectral mask and emissions

7.4.5.1 The power spectral density of the emissions when all active sub-carriers are transmitted in the channel shall be attenuated below the maximum power spectral density as follows:

- a) on any frequency removed from the assigned frequency between 50 and 55 per cent of the authorized bandwidth: $26 + 145 \log(\text{per cent of BW}/50)$ dB;
- b) on any frequency removed from the assigned frequency between 55 and 100 per cent of the authorized bandwidth: $32 + 31 \log(\text{per cent of (BW)}/55)$ dB;
- c) on any frequency removed from the assigned frequency between 100 and 150 per cent of the authorized bandwidth: $40 + 57 \log(\text{per cent of (BW)}/100)$ dB; and
- d) on any frequency removed from the assigned frequency beyond 150 per cent of the authorized bandwidth: 50 dB.

Note.— The power spectral density at a given frequency is the power within a bandwidth equal to 100 kHz centred at this frequency, divided by this measurement bandwidth. It is made clear that the measurement of the power spectral density should encompass the energy over at least one frame period.

7.4.5.2 AeroMACS shall implement power control.

7.4.5.3 AeroMACS minimum rejection for adjacent (± 5 MHz) channel, measured at $\text{BER}=10^{-6}$ level for a victim signal power 3 dB higher than the receiver sensitivity, shall be 10 dB for 16 QAM 3/4.

7.4.5.4 AeroMACS minimum rejection for adjacent (± 5 MHz) channel, measured at $\text{BER}=10^{-6}$ level for a victim signal power 3 dB higher than the receiver sensitivity, shall be 4 dB for 64 QAM 3/4.

7.4.5.5 AeroMACS minimum rejection for second adjacent (+/-10MHz) channel and beyond, measured at BER=10⁻⁶ level for a victim signal power 3 dB higher than the receiver sensitivity, shall be 29 dB for 16 QAM 3/4.

7.4.5.6 AeroMACS minimum rejection for second adjacent (+/-10MHz) channel and beyond, measured at BER=10⁻⁶ level for a victim signal power 3 dB higher than the receiver sensitivity, shall be 23 dB for 64 QAM 3/4.

Note.— For additional clarification to the requirements stated in 7.4.5.3, 7.4.5.4, 7.4.5.5 and 7.4.5.6, refer to IEEE 802.16-2009 section 8.4.14.2.

7.4.6 Frequency tolerance

7.4.6.1 AeroMACS BS transmitter frequency tolerance shall be better than +/- 2×10^{-6} of nominal channel frequency.

7.4.6.2 AeroMACS MS transmitter centre frequency shall be locked to that of the BS transmission centre frequency with a tolerance better than 2 per cent of the subcarrier spacing.

7.4.6.3 AeroMACS MS shall track the frequency of the BS and shall defer any transmission if synchronization is lost or exceeds the tolerances given above.

7.5 PERFORMANCE REQUIREMENTS

7.5.1 AeroMACS communications service provider

7.5.1.1 The maximum unplanned service outage duration on a per aerodrome basis shall be 6 minutes.

7.5.1.2 The maximum accumulated unplanned service outage time on a per aerodrome basis shall be 240 minutes/year.

7.5.1.3 The maximum number of unplanned service outages shall not exceed 40 per year per aerodrome.

Note.— The requirements given in 7.5.1.1 to 7.5.1.3 refer to the overall service provision by the AeroMACS communication service provider on the aerodrome surface. This may include other media which can provide alternate communication paths in the event of an AeroMACS failure.

7.5.1.4 Connection resilience. The probability that a transaction will be completed once started shall be at least 0.999 for AeroMACS over any one-hour interval.

Note.— Connection releases resulting from AeroMACS handover between base stations, log-off or circuit pre-emption are excluded from this specification.

7.5.2 Doppler shift

7.5.2.1 AeroMACS shall operate with a Doppler shift induced by the movement of the MS up to a radial speed of 92.6 km (50 NM) per hour, relative to the BS.

7.5.3 Delay

7.5.3.1 Subnetwork entry time shall be less than 90 seconds.

7.5.3.2 **Recommendation.**— *Subnetwork entry time should be less than 20 seconds.*

7.5.3.3 The from-MS data transit delay (95th percentile) for the highest priority data service, shall be less than or equal to 1.4 seconds over a window of 1 hour or 600 SDUs, whichever is longer.

7.5.3.4 The to-MS data transit delay (95th percentile) for the highest priority data service, shall be less than or equal to 1.4 seconds over a window of 1 hour or 600 SDUs, whichever is longer.

7.5.4 Integrity

7.5.4.1 AeroMACS BS and MS shall support mechanisms to detect and correct corrupt SNSDUs.

7.5.4.2 AeroMACS BS and MS shall only process SNSDUs addressed to themselves.

7.5.4.3 **Recommendation** .— *The residual error rate, to/from MS should be less than or equal to 5×10^{-8} per SNSDU.*

Note.— *There are no integrity requirements for SNSDU residual rate to the BS and MS as the requirement is entirely satisfied by the end-to-end systems in the aircraft and air traffic service provider.*

7.5.4.4 The maximum bit error rate shall not exceed 10^{-6} after CTC-FEC, if the received signal is equal to or greater than the minimum sensitivity level for the modulations scheme used, as given in Table 7-1.

7.5.5 Security

7.5.5.1 AeroMACS shall provide a capability to protect the integrity of messages in transit.

Note.— *The capability includes cryptographic mechanisms to provide integrity of messages in transit.*

7.5.5.2 AeroMACS shall provide a capability to protect the availability of the system.

Note.— *The capability includes measures to ensure that the system and its capacity are available for authorized uses during unauthorized events.*

7.5.5.3 AeroMACS shall provide a capability to protect the confidentiality of messages in transit.

Note.— The capability includes cryptographic mechanisms to provide encryption/decryption of messages.

7.5.5.4 AeroMACS shall provide an authentication capability.

Note.— The capability includes cryptographic mechanisms to provide peer entity authentication, mutual peer entity authentication, and data origin authentication.

7.5.5.5 AeroMACS shall provide a capability to ensure the authenticity of messages in transit.

Note.— The capability includes cryptographic mechanisms to provide authenticity of messages in transit.

7.5.5.6 AeroMACS shall provide a capability to authorize the permitted actions of users of the system.

Note.— The capability includes mechanisms to explicitly authorize the actions of authenticated users. Actions that are not explicitly authorized are denied.

7.5.5.7 If AeroMACS provide interfaces to multiple domains, AeroMACS shall provide capability to prevent intrusion from lower integrity domain to higher integrity domain.

7.6 SYSTEM INTERFACES

7.6.1 AeroMACS shall provide data service interface to the system users.

7.6.2 AeroMACS shall support notification of the status of communications.

Note.— This requirement could support notification of the loss of communications (such as join and leave events).

7.7 APPLICATION REQUIREMENTS

7.7.1 AeroMACS shall support multiple classes of services to provide appropriate service levels to applications.

7.7.2 If there is a resource contention, AeroMACS shall pre-empt services with a lower priority than those given in Annex 10, Volume II, 5.1.8

End of new text.

Source B

PART II — VOICE COMMUNICATION SYSTEMS

...

CHAPTER 2. AERONAUTICAL MOBILE SERVICE

...

Insert new text as follows:

2.5 Satellite voice (SATVOICE) communication system characteristics

Note.— Guidance material for the implementation of the aeronautical mobile satellite service is contained in the Manual on the Aeronautical Mobile Satellite (Route) Service (Doc 9925). Additional guidance for SATVOICE communication systems is contained in the Satellite Voice Operations Manual (Doc 10038), and the Performance-based Communication and Surveillance (PBCS) Manual (Doc 9869).

2.5.1 For ground-to-air calls, the SATVOICE communication system shall be capable of contacting the aircraft and enabling the ground party/system to provide, as a minimum, the following:

- a) secure calling;
- b) priority level as defined in **Table 2-1**; and
- c) aircraft SATVOICE number, which is the aircraft address expressed as an 8-digit octal number.

2.5.2 For ground-to-air calls, the SATVOICE communication system shall be capable of locating the aircraft in the appropriate airspace regardless of the satellite and ground earth station (GES) to which the aircraft is logged on.

2.5.3 For air-to-ground calls, the SATVOICE communication system shall be capable of:

- a) contacting the aeronautical station via an assigned SATVOICE number, which is a unique 6-digit number or public switched telephone network (PSTN) number; and
- b) allowing the flight crew and/or aircraft system to specify the priority level for the call as defined in **Table 2-1**.

Table 2-1. Priority levels for SATVOICE calls (air-to-ground/ground-to-air)

Priority level	Application category
1 / EMG / Q15 Emergency (highest) Safety of flight	Distress and urgency. For use by flight crew, when appropriate.
2 / HGH / Q12 Operational high (second highest) Safety of flight	Flight safety. Typically assigned to calls between aircraft and ANSPs.
3 / LOW / Q10 Operational low (third highest) Safety of flight	Regularity of flight, meteorological, administrative. Typically assigned to calls between aircraft operators and their aircraft.
4 / PUB / Q9 Non-operational (lowest) Non safety	Public correspondence.

End of new text.

APPENDIX D

AMENDMENT 90 TO THE INTERNATIONAL STANDARDS AND RECOMMENDED PRACTICES

**ANNEX 10 — AERONAUTICAL TELECOMMUNICATIONS
VOLUME III — COMMUNICATION SYSTEMS**

RESOLUTION OF ADOPTION

The Council

Acting in accordance with the Convention on International Civil Aviation, and particularly with the provisions of Articles 37, 54 and 90 thereof,

1. *Hereby adopts* on [D] Amendment 90 to the International Standards and Recommended Practices contained in the document entitled *International Standards and Recommended Practices, Aeronautical Telecommunications, Communication Systems* which for convenience is designated Annex 10, Volume III to the Convention;
2. *Prescribes* [*] July 2016 as the date upon which the said amendment shall become effective, except for any part thereof in respect of which a majority of the Contracting States have registered their disapproval with the Council before that date;
3. *Resolves* that the said amendment or such parts thereof as have become effective shall become applicable on 10 November 2016;
4. *Requests the Secretary General:*
 - a) to notify each Contracting State immediately of the above action and immediately after [*] July 2016 of those parts of the amendment which have become effective;
 - b) to request each Contracting State:
 - 1) to notify the Organization (in accordance with the obligation imposed by Article 38 of the Convention) of the differences that will exist on 10 November 2016 between its national regulations or practices and the provisions of the Standards in the Annex as hereby amended, such notification to be made before 10 October 2016, and thereafter to notify the Organization of any further differences that arise;
 - 2) to notify the Organization before 10 October 2016 of the date or dates by which it will have complied with the provisions of the Standards in the Annex as hereby amended;
 - c) to invite each Contracting State to notify additionally any differences between its own practices and those established by the Recommended Practices, when the notification of such differences is important for the safety of air navigation, following the procedure specified in subparagraph b) above with respect to differences from Standards.

— — — — —

APPENDIX E

AMENDMENT TO THE FOREWORD OF ANNEX 10, VOLUME III

Add the following elements at the end of Table A:

<i>Amendment</i>	<i>Source(s)</i>	<i>Subject</i>	<i>Adopted/Approved Effective Applicable</i>
90	Communications Panel (CP); the Secretariat Second meeting of the Operational Data Link Panel (OPLINKP/2)	a) introduction of the aeronautical mobile airport communications system (AeroMACS); and b) introduction of a new section on satellite voice (SATVOICE).	D * 10 November 2016

APPENDIX 4B

ATS EXTENDED SERVICES TRIAL TEAM

(ASTT)

S/N	State	Name	Title	Email	Tel.	Mobile
1	Egypt	Mohamed Ramzy Mohamed	Director of AFTN/AMHS	mrma_eg@yahoo.com	+2022657981	+201007736780
2	Egypt	Tarek Zaky Ahmed	Telecommunication Inspector	Tarekzaky6@gmail.com Tarekzaky5@yahoo.com		+201144207020
3	Egypt	Essam Helmy Mohamed Hassanin	Operations Manager for Cairo Com Center	Essamhelmi07@hotmail.com	+20222607946	+201001122505
4	Egypt	Ahmed Mohamed Ahmed Farghaly	Telecommunication Officer	Ahmed_farghaly222@yahoo.com	+20222607946	+201226371808
5	Iran	Aliakbar Salehi Valujerdi	Senior AFTN/AMHS Training Expert	aasalehi@airport.ir akbarsalehi@gmail.com	+982163146413	+989124202775
6	Iran	Alireza Mahdavisefat	Senior AFTN/AMHS Network Steering Expert	mahdavi@airport.ir amahdavis@gmail.com	+982161022406	+989203991356
7	Jordan	Mona Alnaddaf	Head	aftn_ais@carc.gov.jo	+9626 488 1473	+96279 9876710
8	Kuwait	Hasan Abdul Redah Al-Attar	Comm Engineer	ha.alattar@dgca.gov.kw	+96524721279	+96599449454
9	Oman	Abdullah Al Shaaili		alshaaili@paca.gov.om	+96824519492	+96899334647

S/N	State	Name	Title	Email	Tel.	Mobile
10	Oman	Mashaal Abdul Aziz Al Balushi	AISO – PACA –	Mashaal@paca.gov.om	+968 24519120	+96899628244
11	Saudi Arabia	Ibraheem Mohammed Basheikh	Senior Software Engineer	Ibasheikh@gaca.gov.sa	+966 12671771	+966505671231
12	Sudan	Mubark Galaleldin Abuzaid	System Engineer	Mubark_g@hotmail.com	+249 183770001	+249123499394
13	Tunisia	Bouزيد Issam	AFTN/AMHS Opération Manager, Deputy Project Manager AMHS (OACA)	issam.bouزيد@oaca.nat.tn	+216 58379979	+216583799795
14	U.A.E.	Yousif Al Awadi	Senior Research and Dataset Officer	yawadi@szc.gcaa.ae	+971 25996630	+971504188799

APPENDIX 4C



**ATS Extended Services Trial
File Transfer Body Part (FTBP) Testing Document**

Author: ATS extended Services Trial Team (ASTT)
Date: 10/1/2016
Version: 0.1 (Initial Draft)

Table of Contents

1. Introduction.....	4
2. Test Environment.....	4
3. Test Procedure.....	5
4. Test Summary.....	9
5. ATS Extended Services Trial Team.....	10

References

- [1] ICAO Annex 10 – Aeronautical Telecommunication; Vol.II, Communication Procedure
- [2] ICAO doc 9880- Manual on Detailed Technical Specifications for the Aeronautical Telecommunication Network (ATN) using ISO/OSI Standards and Protocols, Part II – Ground-Ground Applications - Air Traffic Services Message Handling Services (ATSMHS), First Edition – 2010
- [3] EUR Doc 020 – AMHS Manual

1. Introduction

The Message Handling service provided in the ATN is called the ATS Message Handling Service (ATSMHS). This service is specified using X.400 standards. There are two levels of ATSMHS service: Basic ATS Message Service and Extended ATS Message Service. Basic ATS Message Service provides a nominal capability equivalent from a user perspective to those provided by AFTN. And Extended ATS Message Service provides enhanced features such as supporting transfer of more complex message structures (body parts), use of the directory service, and support for security.

The purpose of this document is to define the functional tests for ATS Extended Service handling specially File Transfer body part (FTBP) in order to ensure the end-to-end capability of AMHS systems and network to exchange this type of messages. These tests are performed after the successful operation of AMHS basic services, through which the compliance of all systems to the AMHS technical specifications has been demonstrated and proved.

2. Test Environment

Both test systems should have operational AMHS link, and P1 connection setup. Two User Agents should be used to exchange traffic with File Transfer Body Part. The testing environment is as shown in the figure below:

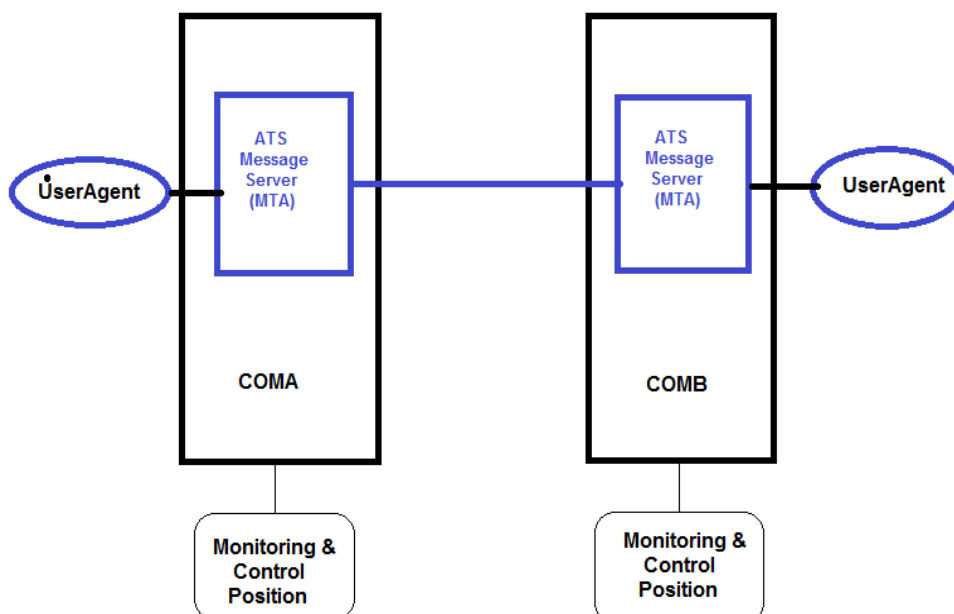

The test can be performed in AMHS Network and unnecessary to have direct AMHS link between the two COM centers, the traffic can be exchanged via intermediary(ies) COM center(s), which should be involved in the test activities.

The User Agent address at COM A could be "COMAASTT", and at COM B "COMBASTT". The User Agent can be either P3 or P7 User Agent.

Network Analysis software can be used to monitor X.400 traffic and its effect on network Bandwidth. The software can be agreed on prior the test.

3. Test Procedure

Before the tests, the test partners should coordinate and document the type of body part used in IPMs submitted by their User Agents when submitting text messages, either as:

- IPMs containing a basic ia5-text body part, or
- IPMs containing an extended ia5-text body part, or
- IPMs containing a general-text body part with ISO646 repertoire.

3.1 Submission, Transfer and Delivery of a message including Binary file from UserAgent to UserAgent.

Test01	Submission of Binary file
Test Criteria	The Test is successful if COMB receive the message with Binary file attached with text message from COMA
Scenario Description	<p>From the UA of COMA send a sequence of five ATS messages (IPMs) to the COMB addressing the COMBASTT.</p> <ul style="list-style-type: none"> • Message 1 (Test011) shall have ATS-message-priority KK and binary file • Message 2 (Test012) shall have ATS-message-priority GG and binary file • Message 3 (Test013) shall have ATS-message-priority FF and binary file • Message 4 (Test014) shall have ATS-message-priority DD and binary file attached • Message 5 (Test015) shall have ATS-message-priority SS and binary file attached <p>Each message shall have different ATS-filing-time and ATS-message-text.</p> <p>Verify the messages received by the remote UA.</p> <p>In particular, verify:</p> <ul style="list-style-type: none"> • ATS-message-priority, • ATS-message-filing-time, • ATS-message-text. • The Binary file
Reference	9880

Test02	Submission of Binary file
Test Criteria	The Test is successful if COMA receive the message with Binary file attached with text message from COMB
Scenario Description	<p>From the UA of COMB send a sequence of five ATS messages (IPMs) to the COMA addressing the COMAASTT.</p> <ul style="list-style-type: none"> • Message 1 (Test021) shall have ATS-message-priority KK and binary file • Message 2 (Test022) shall have ATS-message-priority GG and binary file • Message 3 (Test023) shall have ATS-message-priority FF and binary file • Message 4 (Test024) shall have ATS-message-priority DD and binary file attached • Message 5 (Test025) shall have ATS-message-priority SS and binary file attached <p>Each message shall have different ATS-filing-time and ATS-message-text.</p> <p>Verify the messages received by the remote UA.</p> <p>In particular, verify:</p> <ul style="list-style-type: none"> • ATS-message-priority, • ATS-message-filing-time, • ATS-message-text. • The Binary file
Reference	9880

3.2 Submission, Transfer and Delivery of a message including Binary file from UserAgent to AFTN User

Test031	Submission of Binary file to AFTN User
Test Criteria	The Test is successful if COMA receive Non Delivery report (NDR) from the Gateway of COMB
Scenario Description	<p>From the UA of COMB send a an ATS messages (IPMs) with binary file attached to the COMA addressing an AFTN user like the control tower COMAZTZX.</p> <ul style="list-style-type: none"> • Message 1 (Test031) shall have ATS-message-priority FF and binary file <p>Verify the messages not received by the remote AFTN User and that the sender receive NDR</p>
Reference	9880

Test032	Submission of Binary file to AFTN User
Test Criteria	The Test is successful if COMB receive Non Delivery report (NDR) from the Gateway of COMA
Scenario Description	<p>From the UA of COMA send a an ATS messages (IPMs) with binary file attached to the COMB addressing an AFTN user like the control tower COMBZTZX.</p> <ul style="list-style-type: none"> • Message 1 (Test032) shall have ATS-message-priority FF and binary file <p>Verify the messages not received by the remote AFTN User and that the sender receive NDR</p>
Reference	9880

4. Test Summary

Use the Network Analysis software to analyze the traffic overhead occurred when sending binary files with the message. Also document the message size on system hard disks. Monitor any warning message or alarm during the tests.

Stress tests can be performed, by sending 20, 50 messages repeating test Test01 and Test02. Network and system response should be carefully monitored in order not affecting the life traffic.

5. ATS Extended Services Trial Team (ASTT)

State	Name	Title	Email	Tel. / Mobile
Bahrain	Mr. Mohamed Ali Saleh	Chief, Aeronautical Telecommunication	masaleh@caa.gov.bh	+973 17 321 187 +973 396220202
	Mr. Yaseen Hassan Al Sayed	Head ATN, Senior Computer Network Administrator	y.alsayed@caa.gov.bh	+97317329966/ +97339520025
Egypt	Mohamed Ramzy Mohamed	Director of AFTN/AMHS	mrma_eg@yahoo.com	+2022657981/ +201007736780
	Tarek Zaky Ahmed	Telecommunication Inspector	Tarekzaky6@gmail.com Tarekzaky5@yahoo.com	+201144207020
	Essam Helmy Mohamed Hassanin	Operations Manager for Cairo Com Center	Essamhelmi07@hotmail.com	+20222607946/ +201001122505
	Ahmed Mohamed Ahmed Farghaly	Telecommunication Officer	Ahmed_farghaly222@yahoo.com	+20222607946/ +201226371808
Iran	Aliakbar Salehi Valujerdi	Senior AFTN/AMHS Training Expert	aasalehi@airport.ir akbarsalehi@gmail.com	+982163146413/ +989124202775
Iran	Alireza Mahdavisefat	Senior AFTN/AMHS Network Expert	mahdavi@airport.ir amahdavis@gmail.com	+982161022406/ +989203991356
Jordan	Mona Alnaddaf	Chief of the AFS Engineering	aftn_ais@carc.gov.jo	+9626 488 1473/ +96279 9876710
Kuwait	Hasan Abdul Redah Al-Attar	Comm Engineer	ha.alattar@dgca.gov.kw	+96524721279/ +96599449454
Oman	Abdullah Al Shaaili		alshaaili@paca.gov.om	+96824519492 / +96899334647
	Mashaal Abdul Aziz Al Balushi	AISO – PACA	Mashaal@paca.gov.om	+968 24519120/ +96899628244
Saudi Arabia	Ibraheem Mohammed Basheikh	Senior Software Engineer	ibasheikh@gaca.gov.sa	+966 12671771/ +966505671231
Sudan	Mubark Galaleldin Abuzaid	System Engineer	Mubark_g@hotmail.com	+249 183770001/ +249123499394
Tunisia	Bouزيد Issam	AFTN/AMHS Opération Manager	issam.bouزيد@oaca.nat.tn	+216 58379979 +216583799795
U.A.E.	Yousif Al Awadi	Senior Research and Dataset Officer	yawadi@szc.gcaa.ae	+971 25996630 +971504188799

APPENDIX 4D

SITA AMHS Gateway Interconnection Topology
in MID Region

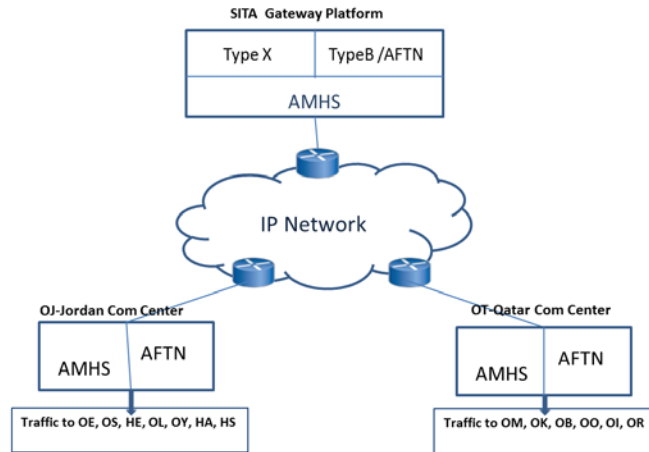

7/12/2015

©SITA 2015 COMPANY CONFIDENTIAL

1



SITA Migration Plan to AMHS

Author: <enter name>

Document version: 1.0.1

Document Date: December 2015



Revision History

Date	Version	Description (which must identify key changes occurred since previous revision)	Author
9/9/2015	0.1	Initial Draft	Mansour Rezaei Mazinani
15/12/2015	1.0.1	draft version	Mansour Rezaei Mazinani

Approvals

Version	Approved By	Signed	Date



Table of Contents

1.	Introduction	4
1.1.	Context	4
1.2.	Purpose of the document	5
2.	Overview of SITA AMHS Gateway and Interconnection to AMHS	6
2.1.	Overview of SITA AMHS Gateway Platform	6
2.2.	Overview of SITA terminals	8
2.3.	Message Formats and Format Conversion	8
2.3.1.	From Type B to AMHS	8
2.3.2.	From AMHS to Type B	9
2.4.	AMHS Address allocation and Controls	11
2.5.	Principles of Interoperability with AMHS	12
2.6.	Regional Interconnection Topologies and time frames	12
2.6.1.	SITA AMHS Gateway Interconnections Topology in EUR Region	13
2.6.2.	SITA AMHS Gateway Interconnection Topology in APAC Region	13
2.6.3.	SITA AMHS Gateway Interconnection Topology in NAM Region	14
2.6.4.	SITA AMHS Gateway Interconnection Topology in MID Region	15
2.6.5.	SITA AMHS Gateway Interconnection Topology in AFI Region	16
2.7.	Global Interconnection Topology	16
2.8.	SITA and AMHS Gateway COM Centers Role and Responsibility	17
3.	Principles of SITA Migration to AMHS	19
3.1.	SITA and COM Center Pre-migration set up and Validation	19
3.2.	Principles and procedures for Migration	19
4.	Use of AMC	21
4.1.	User look-up table introduction in AMC, validation and use	21
4.2.	New SITA user introduction and maintenance	21
5.	AMHS Migration Tentative Plan	22
5.1.	AMHS migration in ICAO EUR Region	22
5.2.	AMHS migration in ICAO APAC Region	22
5.3.	AMHS migration in ICAO NAM region	22
5.4.	AMHS migration in ICAO MID region	22
5.5.	AMHS migration in ICAO SAM region	22
5.6.	AMHS migration in ICAO AFI region	22
6.	References	23



1. Introduction

1.1. Context

SITA has been operating an AFTN – Type B gateway for decades. The service is today connected to the AFTN network in limited number of countries. These inter-connections allow ATS organizations and airlines to communicate using AFTN messages on the ATS organizations' side and Type B messages on the airlines' side. The SITA service provides all necessary conversions to enable seamless data exchange between ATS organizations and airlines.

AMHS is under active deployment by majority of ANSPs in all ICAO Regions in view of AFTN interconnection replacement. Additionally the new rich data formats including XML based aeronautical messages are planned to be used over the next few years to further improve air traffic management effectiveness which requires the use of new generation messaging based on ICAO AMHS standards.

The move to this new communication path for SITA requires AMHS and appropriate gateway deployment and interconnections to AMHS in most of ICAO Regions to continue to support data exchange between ATS Organizations which will increasingly use AMHS and airlines using Type B or Type X for XML based information such as digital NOTAMs.

To this end SITA engaged with ICAO EUR/NAT Region in 2012 for AMHS planning and to follow the required ICAO procedures and necessary clarifications for the development and deployment of necessary components to enable regional interconnections to AMHS and migration from AFTN without traffic interruption.

Subsequently and following ICAO EURNAT AFSG recommendations SITA worked with ICAO EURNAT AFSG - Operations Group to elaborate a detailed architecture for SITA interconnection to AMHS in a mixed AMHS and AFTN environment which specifies the details of addressing and routing for message exchanges between ATS and SITA users. AMHS / SITA Interconnection Architecture Version 1.0 document is approved during ICAO EURNAT AFSG/17 meeting which took place in Paris from 22 to 26 April 2013 and was updated to Version 2.0 at AFSG/19 in April 2015.

Following the technical and operational recommendations elaborated as a part of the AMHS/SITA Type X Interconnection Architecture document (Ref. 6), SITA addressing scheme changed from CAAS to XF scheme as C=XX/A=ICAO/P=SITA/O=AFTN/OU=AFTNADDR, where AFTNADDR is an AFTN address of a SITA user.

SITA's AMHS Gateway is in production since November 2014 and ready for AMHS interconnections with ANSPs as necessary.

At the time of writing this document, only the ICAO EUR Region has formally accepted the migration of the existing Regional AFTN interconnections toward AMHS. 3 other ICAO Regions namely APAC, SAM and MID Regions accepting the principle propose to liaise and plan with the concerned ANSPs. For NAM region an engagement with FAA is initiated.

Due to the need to have global approach in the transition from AFTN to AMHS, between SITA and the AFS, the ICAO EUR AFSG has invited all Regions and SITA for a workshop in Atlanta with the scope to continue the transition but in a globally coordinated manner.

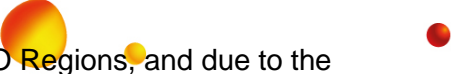

Taking into account the AMHS deployment status and plans in all ICAO Regions, and due to the agreement in the EUR Region to migrate to AMHS with SITA in short term, the global transition toward AMHS should include this element and adapt the migration accordingly.

1.2. Purpose of the Document

The purpose of the document is to provide:

- An abreast of the SITA infrastructure components related to messages exchanges with AFS users globally.
- The appropriate migration principles and necessary details related to addressing and address management.
- Expected message formats.
- Regional AMHS interconnection topologies and routing principles.
- AMC use
- And steps and procedures necessary to progressively migration SITA traffic from AFTN to AMHS

This document is expected to be shared with all ICAO Regions as a precondition to prepare and enable the migration of SITA users message traffic from AFTN to AMHS.

2. Overview of SITA AMHS Gateway and Interconnection to AMHS

2.1. Overview of SITA AMHS Gateway Platform

This section describes the components of SITA gateway platform and the general data flows between SITA and the AFS.

Currently SITA users use Type B to exchange with AFS users using AFTN. For interconnections with AMHS a new gateway was integrated in the current SITA Type B and AFTN related systems to allow migration from AFTN to AMHS.

In a next step when SITA users start using Type X for exchanges with AFS users the related gateway in place will support the exchanges with AFS users.

The following diagram illustrates the current message flow through Type B and AFTN messaging networks, as well as the migration path from AFTN to AMHS. It also illustrates the Type X flow to AMHS.

Type X being based on XML and Web services technologies is to convert to AMHS for exchanges with AMHS users as we progress in the planned AMHS interconnections. And in the meanwhile and while Type B is used the defined gateway and flow continue.

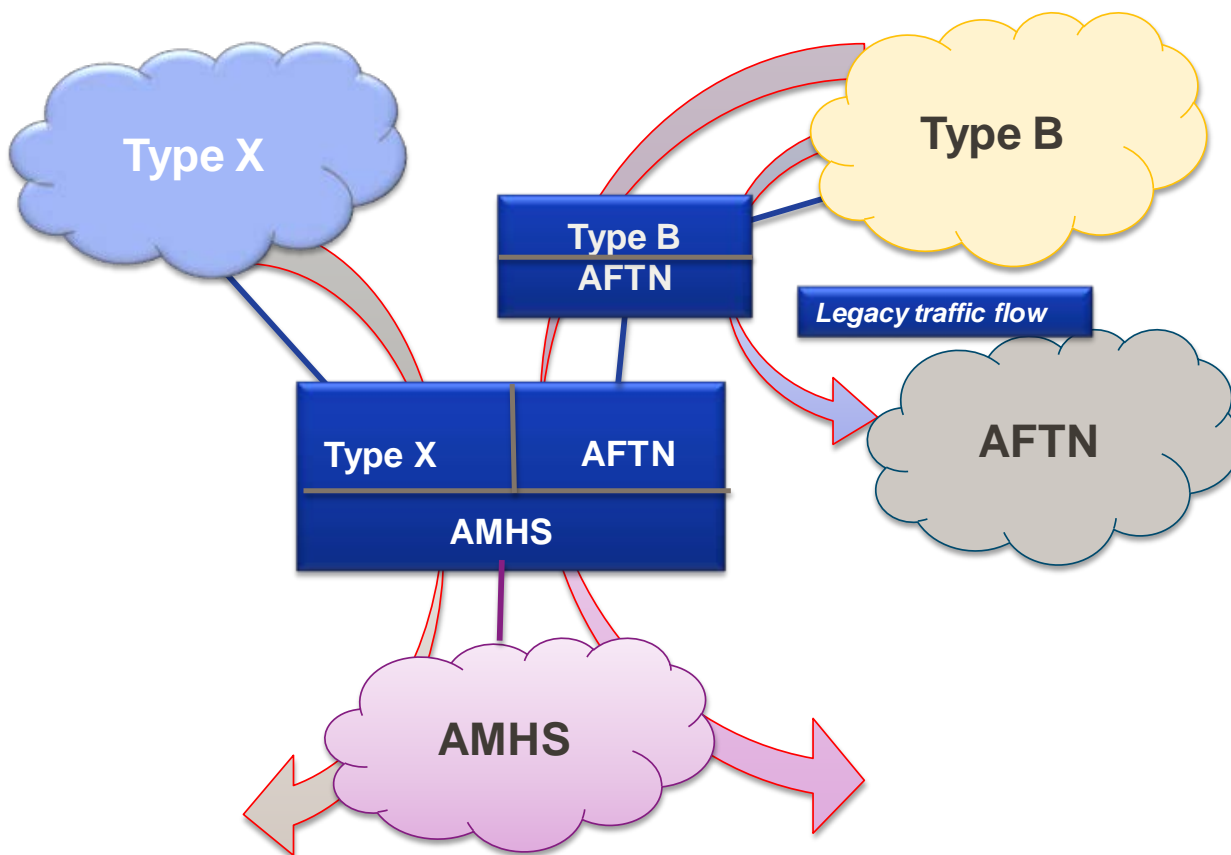

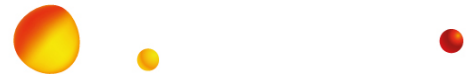

The following diagram illustrates the two gateways, namely the Type B – AFTN Gateway and the Type X and AFTN/AMHS Gateway, which are already deployed in SITA data centers with back up and disaster recovery.

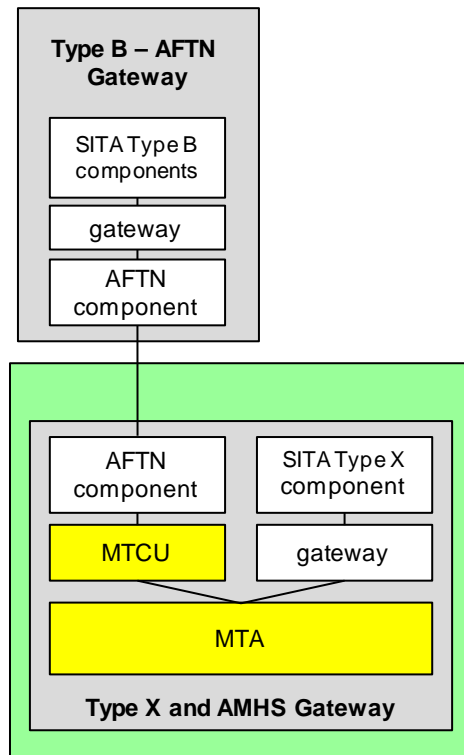

Considering that through decades of exchanges with AFTN, several specific procedures have been developed to allow adoption to ANSP or airline profiles, the use of Type B – AFTN Gateway is to avoid any miscommunication due to message conversions and to continue communication with AFTN while we prepare to move to AMHS.

The latter gateway includes a standard AFTN/AMHS Gateway compliant with ICAO specifications and enables standard conversion of AFTN messaging to/from AMHS.

The combination of the two gateways allows continuation of exchanges with AFTN. And as we move to AMHS, the related AFTN messages get converted to AMHS for delivery over the operational AMHS connections.

The move to AMHS will be entirely coordinated with respective COM Centre gateways and the related ICAO Regional forums.

The rules for address control and validation are enforced during the migration to AMHS. Both gateways have address control capabilities for Type B as well as AFTN addresses.

2.2. Overview of SITA Terminals

SITA users are connected to Type B network using either a SITA package SITATEX over an IP connections or by applications related to flight operations running on servers connecting to SITA over protocols including MQ or MATIP (an RFC for airline traffic over IP).

Each terminal or application is identified by a Type B address (based on IATA location codes and designators).

Type X users have similar environment. However Type X being based on XML and Web Service technologies use IATA Type X XML schemas and are connected using HTTP(-S) or MQ. Type X can use IATA or ICAO AFTN addresses indifferently.

2.3. Message Formats and Format Conversion

Although we are concerned about the end to end format in Type B and AMHS domains, in the following the different cases of format conversions are demonstrated for better clarification.

2.3.1. From Type B to AMHS

This section provides two message examples used by SITA users and the steps of conversion from Type Bs through AFTN and then to AMHS for delivery via AMHS connections.

Therefore the AFTN message format shown in this section should be expected from SITA for routing and delivery towards AMHS. The resulting AMHS message in this section should be expected from SITA on the AMHS connections for standard routing based on PRMD.

2.3.1.1. Type B message with non-AFTN Payload

The Type B message with IEVYAPS recipient address is routed within SITA infrastructure to Type B/AFTN Gateway for sending to AFTN. There is an AFTN address mapping for both originator and recipient Type B addresses which is used for form the AFTN envelop.

The Type B simple format is;

```
QN IEVYAPS
.SINXTSQ 120123
TEXT
TEXT
```

The converted AFTN message format where IEVYAPS mapped to UKKAYAYF and SINXTSQ mapped to WSSSSIAX to form the AFTN message envelop is;

```
GG UKKAYAYF
120124 WSSSSIAX
QN IEVYAPS
.SINXTSQ 120123
TEXT
TEXT
```

And the AFTN/AMHS Gateway converts to AMHS under related AMHS scheme and PRMD name to;

```
Originator      : /C=XX/A=ICAO/P=SITA/O=AFTN/OU1=WSSSSIAX
Recipient[1]   : /C=XX/A=ICAO/P=UKRAINE/O=AFTN/OU1=UKKAYAYF
PRI            : GG
FT             : 120124
QN IEVYAPS
.SINXTSQ 120123
TEXT
TEXT
```

2.3.1.2. Type B message with AFTN Payload

Type B Message with recipient address HDQYFXS is routed through SITA infrastructure to AFTN gateway for which there is a setting for Type B header stripping. The resulting AFTN message is then converted to AMHS.

The sequence of subsequent Type B, AFTN and then AMHS messages are as follows:

Type B message;

```
QN HDQYFXS
.SINXTSQ 120124
GG UKKAYAYF
120124 WSSSSIAX
AFTN TEXT
```

AFTN Message (the Type B header is stripped)

```
GG UKKAYAYF
120124 WSSSSIAX
AFTN TEXT
```

AMHS message

```
Originator      : /C=XX/A=ICAO/P=SITA/O=AFTN/OU1=WSSSSIAX
Recipient[1]   : /C=XX/A=ICAO/P=UKRAINE/O=AFTN/OU1=UKKAYAYF
PRI            : GG
FT             : 120124
AFTN TEXT
```

2.3.2. From AMHS to Type B

The section describes the message formats expected from AMHS for conversion and delivery to Type B user.

2.3.2.1. AMHS message with non-Type B Payload (regular AMHS message)

```
Originator      : /C=XX/A=ICAO/P=THAILAND/O=VTBB/OU1=VTBB
                  /CN=VTBBZTZX
Recipient[1]   : /C=XX/A=ICAO/P=SITA/O=AFTN/OU1=RPLLALX
PRI            : GG
FT             : 120123
CONFIRM RECEPTION OF YR 120122 RPLLALX
BRGDS VTBBZTZX
```

The message is then converted with SITA gateway platform as described in section 2.1 to AFTN and then Type B as follows for routing and delivery to Type B user;

AFTN message

```
GG RPLLPALX
120123 VTBBZTZX
CONFIRM RECEPTION OF YR 120122 RPLLPALX
BRGDS VTBBZTZX
```

And Type B message (RPLLPALX being converted to MNLXTPR and SLCXAXS being the Type B service address of the input connection. This is then sent to Type B user.

```
QN MNLXTPR
.SLCXAXS 120123AFTN
GG RPLLPALX
120123 VTBBZTZX
CONFIRM RECEPTION OF YR 120122 RPLLPALX
BRGDS VTBBZTZX
```

2.3.2.2. AMHS message with Type B Payload

AMHS message

```
Originator      : /C=XX/A=ICAO/P=THAILAND/O=VTBB/OU1=VTBB
                 /CN=VTBBZTZX
Recipient[1]    : /C=XX/A=ICAO/P=SITA/O=AFTN/OU1=WSSSSITX
PRI             : GG
FT              : 120123
QU SINXTSQ
.ATLXTDL 121212
TEXT
TEXT
```

AFTN message (WSSSSITX is routed to SITA AMHS gateway)

```
GG WSSSSITX
120123 VTBBZTZX
QU SINXTSQ
.ATLXTDL 121212
TEXT
TEXT
```

Type B message (The AFTN Header being stripped off resulting into a standard Type B message)

```
QU SINXTSQ
.ATLXTDL 121212
TEXT
TEXT
```

2.3.2.3. AMHS message with Pilot Address, e.g. WSSSSITA

AMHS message

```
Originator      : /C=XX/A=ICAO/P=THAILAND/O=VTBB/OU1=VTBB
                 /CN=VTBBZTZX
Recipient[1]   : /C=XX/A=ICAO/P=SITA/O=AFTN/OU1=WSSSSITA
PRI            : GG
FT            : 120123
YBBBQFAX
TEXT
TEXT
```

AFTN Message (WSSSSITA being routed to SITA AFTN gateway)

```
GG WSSSSITA
120123 VTBBZTZX
YBBBQFAX
TEXT
TEXT
```

The above message in AFTN gateway - the Pilot address, WSSSSITA, is replaced by the first line of text, and then a Type B header is generated as in message with non-type B payload, (YBBBQFAX being translated to BNEXTQF and SLCXAXS being the type B service address of the input connection and sent to Type B user).

```
QN BNEXTQF
.SLCXAXS 120123AFTN
GG YBBBQFAX
120123 VTBBZTZX
TEXT
TEXT
```

2.4. AMHS Address Allocation and Controls

SITA uses XF addressing scheme with allocated PRMD=SITA. The addressing scheme and use in AMHS is defined in AMHS/SITA Type X Interconnection Architecture document (see reference 6). All SITA user O/R addresses will be defined under PRMD=SITA. All SITA users AFTN addresses are provided by ANSPs.

Currently there are some 1081 SITA users AFTN addresses. However due to practices cumulated over decades there are more Type B addresses than AFTN ones. As some of the message examples in section 2.2 show, there are cases that AFTN/AMHS originators use one AFTN recipient address or SITA gateway AFTN address and include a full Type B message with several addresses in the body of the message to send to several recipients. SITA has initiated a work stream to request the concerned users to contact the related local ANSPs and communicate with one AFTN address for every Type B address only. This however is an ongoing task to reach a one-to-one AFTN-Type B address list.

In AMHS procedures are created within SITA under controlled processes to request the user to provide a valid AFTN address registered with its local ANSP. This address is



checked by SITA provisioning against ICAO location and designator directories (ICAO Doc 7910 and ICAO Doc 8585) prior to its service configuration.

In addition to above SITA uses in its gateways address control and white listing. In case the address control fails, the message is rejected back to the originator.

2.5. ***Principles of Interoperability with AMHS***

SITA's interconnection to AMHS follows and complies with ICAO recommendation for:

- IP network connectivity and testing,
- AMHS Inter-Operability Testing (IOT) using ICAO EUR AMHS Manual, Appendix E
- Pre-operational Testing (POT) defined in ICAO EUR AMHS Manual, Appendix F (see references section), and
- commissioning with adequate principles as follows;
 - Independent AMHS interconnections with ICAO Regions with at least 2 AMHS interconnections per Region and more when the traffic and extend of the Region justifies.
 - Definition and Regional agreements with defined AMHS COM Centers through the related regional ICAO Working Groups.
 - Coordination with defined AMHS Gateway COM Centers and SITA for connections and testing, commissioning and routing to the subsequent COM Centers according to the defined and agreed topologies (see section 2.6 for regional AMHS interconnection topologies.
 - Coordination with AMC Operator and concerned COM Centers for address publication, validation and use.
 - The address use and routing will be according to AMC AIRAC cycle to ensure that all parties have agreed with the new routings
 - SITA ensures that each generated AMHS message contains users addresses listed in the User address look-up table.
 - SITA shall maintain the User address look-up table in the AMC with all SITA users allowed to communicate with AMHS containing their SITA address as well as AFTN address used for the O/R address with PRMD=SITA.
 - The migration of every COM Center traffic through the AMHS gateway COM Center will be done after validation of SITA users addresses with the concerned COM Center and according to AMC AIRAC cycle for use in the respective AMHS user look-up table.
 - The AMHS migration process should be led by the COM Center in closed coordination with SITA

2.6. ***Regional Interconnection Topologies and time frames***

Following the recommendations formulated in the AMHS/SITA Type X Interconnection Architecture document SITA is establishing at least 2 independent interconnections to AMHS in every ICAO Region.

The proposed COM Center for interconnections to AMHS is based on the traffic volume and in turn its AMHS interconnectivity with other COM Centers to reach the final AFS user. In case a final destination COM Center is in AFTN, care is taken to use only one AMHS/AFTN Gateway for conversion to AFTN and delivery to the destination AFTN COM Center.

The proposed SITA interconnections to AMHS in every ICAO Region are as follows:

2.6.1. SITA AMHS Gateway Interconnections Topology in EUR Region

It is expected to complete the migration toward AMHS EUR Region by 2016 with 4 AMHS gateways. During this time no additional AFTN connection will be established between SITA and a COM Center in EUR Region.

After 2016 all the current AFTN interconnections with SITA in the EUR Region should be removed.

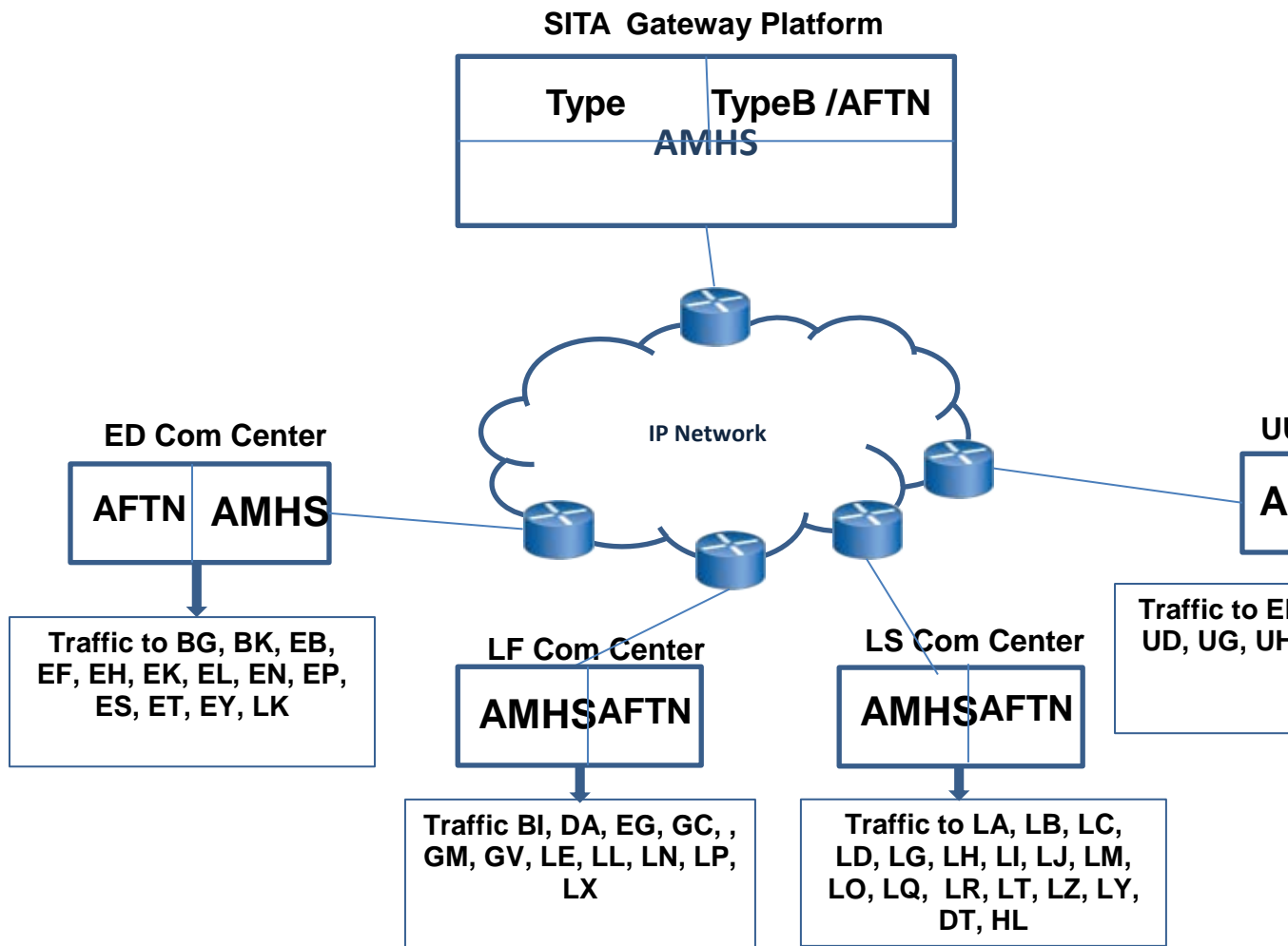

2.6.2. SITA AMHS Gateway Interconnection Topology in APAC Region

It is expected to complete the migration toward AMHS by 2016. During the period 2015 –

2016 the APAC Region traffics will be exchanged between SITA and the AFS via AFTN and AMHS.

As from beginning of 2017 all current AFTN interconnections with SITA in the APAC Region should be removed.

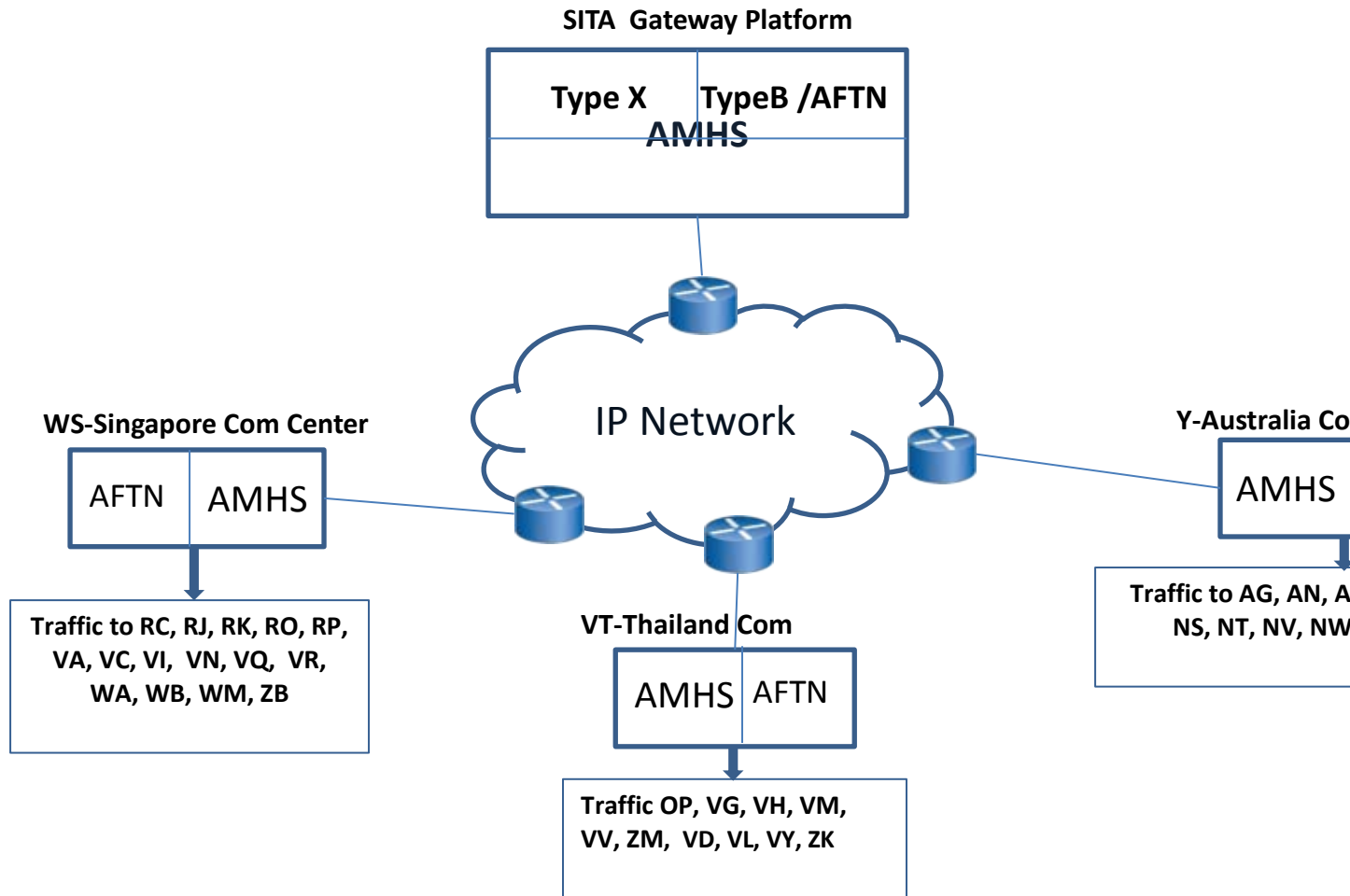

2.6.3. SITA AMHS Gateway Interconnection Topology in NAM Region

It is expected to complete the migration toward AMHS by 2016 with FAA AMHS gateway. During the period 2015 – 2016 the NAM Region traffics will be exchanged between SITA and the AFS via AFTN and AMHS.

After 2016 the current AFTN interconnections with SITA in the NAM Region should be removed.

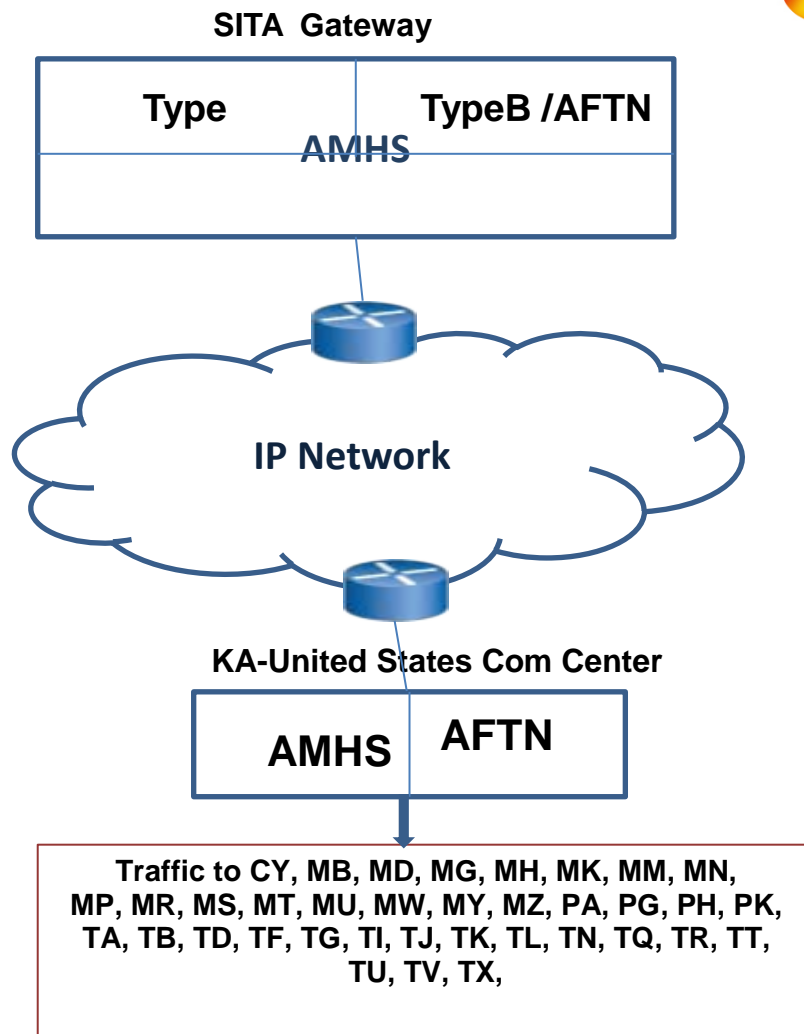

2.6.4. SITA AMHS Gateway Interconnection Topology in MID Region

It's expected to complete the migration toward AMHS in 2016, with 2 AMHS COM Center gateways. During the period 2015 – 2016 the MID Region traffic will be exchanged between SITA and the AFS via AFTN and AMHS.

Currently there is no AFTN connection between SITA and a COM Center within the MID region.

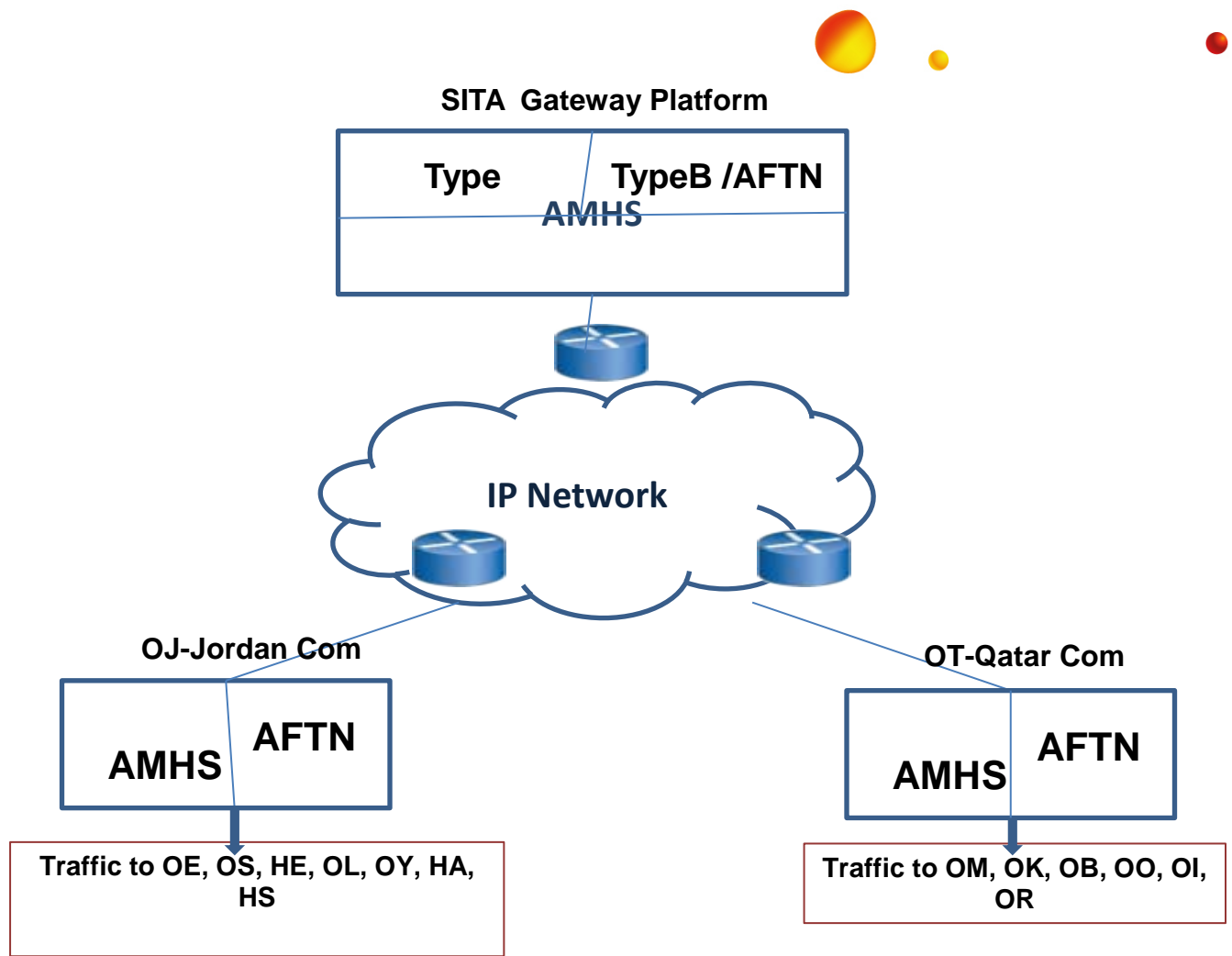

2.6.5. SITA AMHS Gateway Interconnection Topology in AFI Region

At the time of writing this document no information is available related to the appropriate ICAO AFI Working Group to discuss the interconnection with AMHS within AFI Region and after agreements and plan accordingly.

However it is envisaged to connect to South Africa and Dakar. Considering the current state of progress it is expected to have the initial connections late 2016. While the interconnections with AFI Region are not operational the traffic will continue through AFTN.

There is an AFTN interconnection with SITA and South Africa that shall be removed after AMHS connection completion and migration.

Diagram to be added with interconnections to SAA and Dakar

2.7. Global Interconnection Topology

The following diagram illustrates an overview of planned global SITA interconnections to AMHS on a regional basis as described above;

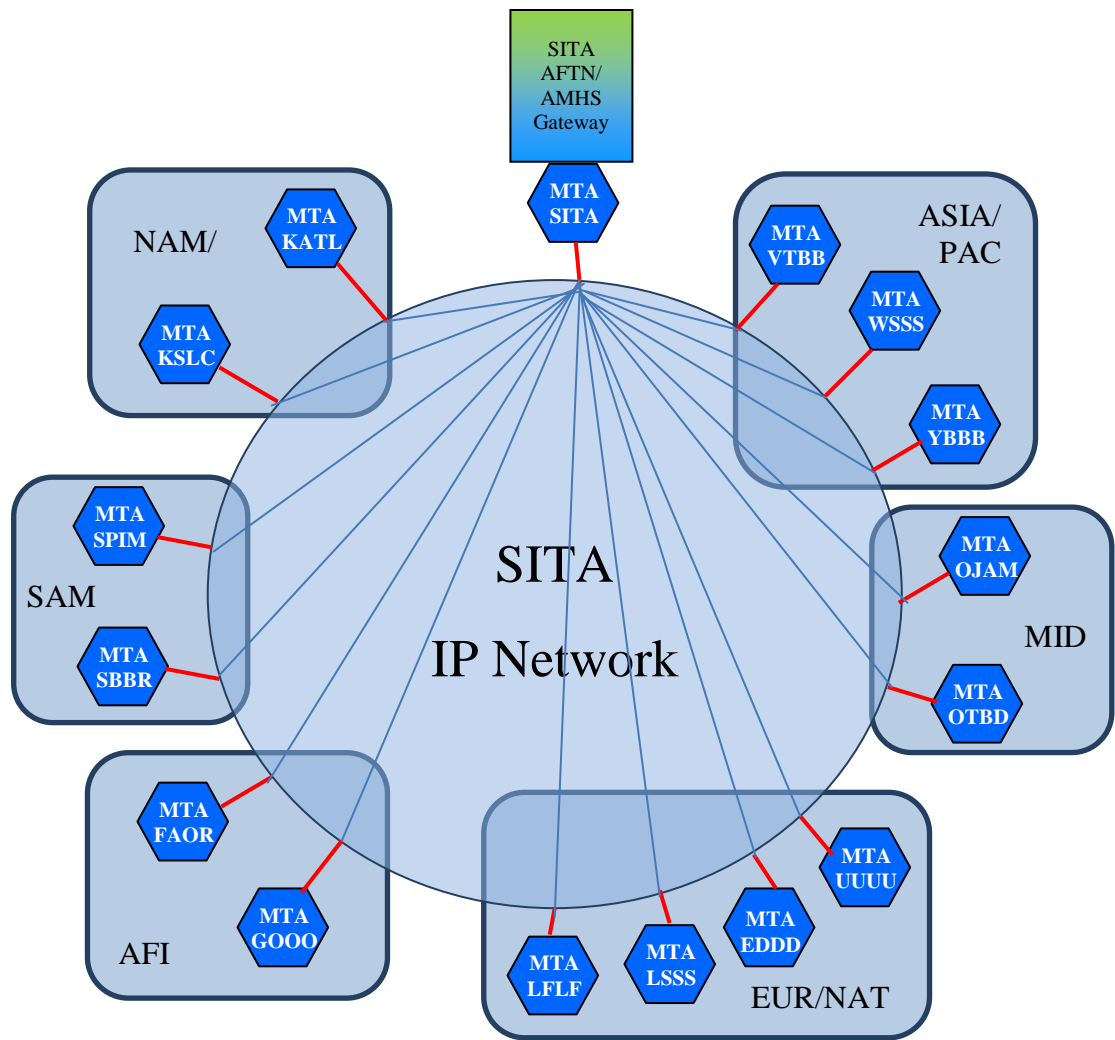

2.8. ***SITA and AMHS Gateway COM Centers Role and Responsibility***

- SITA will convert, relay and deliver the messages received from AMHS Gateway COM Centers to SITA users
- AMHS Gateway COM Centers will relay and deliver the messages received from SITA to the concerned AFS user.
- In case the AFS user is in AFTN the last AMHS COM Center in the routing path converts the message to AFTN for delivery to the AFS user or to the AFTN COM Center responsible for delivery to the intended AFS user.

- 
- The AFTN addresses of all SITA users shall be allocated by the concerned ANSP. These AFTN addresses will then be used by SITA and introduced in AMC under PRMD=SITA.
 - All COM Centers shall validate existing AFTN addresses of SITA users published in AMC.
 - The AMHS address management and use will be done according to the ATS Messaging Management Manual by AIRAC cycles.
 - SITA has established user address validation against ICAO 7910 and 8585 directories and use white listing in its AMHS gateway platform.

3. Principles of SITA Migration to AMHS

3.1. *SITA and COM Center Pre-migration Set up and Validation*

The communications between SITA users and AFS users will follow the migrations plan from AFTN connections to AMHS connection. During this transition the AFTN connections will remain as long as necessary to allow progressive global migration to AMHS. Each time an AMHS connection becomes operational, messages from SITA to AFS with destination addresses related to that AMHS connection will be sent through that AMHS connection while the others continue on AFTN. For messages from AFS to SITA the migrated addresses should then take AMHS path and included in the user look up table.

To prepare for migration SITA has completed new developments to allow step wise and progressive migration of its traffic from AFTN to AMHS in closed coordination with AMHS Gateway COM Centers. SITA users origin addresses are validated at the entry of the gateway and invalid origin addresses are rejected. Additionally the platform can be set up to send selective recipient addresses and flows through AMHS links while all other traffic will continue to be sent on AFTN connections.

At every step an address validation of SITA user addresses under the concerned COM Center will take place. This includes possible use of an AFTN address both with the concerned COM Center as well as with SITA. In this case the user will be required to choose only one or ask for a 2nd address to make sure that the address under the concerned COM Center PRMD and SITA PRMD are different.

Preparations are made prior to Pre-Operational Testing (POT) including address clarification and validation. This and other procedures are then qualified during POT to ensure validation and controlled progressive migration to AMHS.

3.2. *Principles and Procedures for Migration*

This section describes the principles to be used by SITA and AMHS Gateway COM Center to exchange address list, engage for address validation, step by step set up to migrate traffic from AFTN to AMHS. The traffic to every AMHS Gateway COM Center is for its AMHS Gateway COM Center recipients as well as for routing to the COM Centers as defined in the regional topologies in section 2.6.

When the first AMHS connection with a AMHS Gateway COM Center becomes operational, only messages from SITA users to that AMHS Gateway COM Center users will be sent on the active AMHS connection. This will then extend as soon as the AMHS Gateway COM Center is ready to relay to another COM Center according to the defined topology. This pattern will then continue until completion for delivery to all related COM Centers through the AMHS Gateway COM Center. The same principle can then be used with other AMHS Gateway COM Centers.

All SITA user addresses will be in all user look up tables for routing through AMHS to SITA but step wise i.e. initially for SITA user addresses under the AMHS Gateway COM Center location code and progressively adding others as we progress in migration from AFTN to AMHS.

All other messages will continue to be routed through AFTN. When sending through AFTN



the exception table should use the related addresses for delivery to SITA rather than to the ANSP under the location code.

Principles and tasks related AMHS interconnection testing and migration are well defined in ATS Messaging Management Manual and related appendix A (see ref. 4). There are however some specifics related to SITA connection and migration mainly related to SITA users address validation, use of user look up tables and routing exception preparation for ANSPs still in AFTN.

All address introduction and routing will use AMC cycle.

4. Use of AMC



4.1. ***User Look-up Table Introduction in AMC, Validation and Use***

SITA user AFTN addresses shall be registered by the COM Centers where the SITA user is located. The allocated AFTN address of a SITA user will be used to define the O/R address under PRMD=SITA.

SITA provisioning and messaging support shall be allocated read and write access for posting and maintenance of SITA user addresses within SITA PRMD allocated space.

The existing SITA Users Address List is communicated for review. It may be complemented by few other addresses not known due to in-body addressing practice in SITA AFTN messages (see section 2.3 – Message Formats and Format Conversion. Care should be taken in exchanging and using SITA Users Address List due to its confidentially nature (Only for internal use) to be circulated between and accessed by authorized persons. The AMC is the management tool of these addresses for addressing reviews by ANSPs globally and for the use of the addresses in operations.

The procedure to check the AFTN addresses of SITA Users published in AMC (User address table) is defined in EUR Doc 021 – ATS Messaging Management Manual (see reference 4).

At the time of writing this document SITA users address list is prepared and communicated to AMHS Gateway COM Center countries and AMC operator.

The list of SITA appropriate persons with read/write (for operational functions) and read only access (to view operational data) is also communicated to provide access for posting addresses, address management and use in the progressive migration path to AMHS. The AMC access rights for the proposed users follow the model defined in ATS Messaging Management Manual and related appendix B (see ref 4).

4.2. ***New SITA User Introduction and Maintenance***

Introduction of SITA new users and maintenance of SITA user addresses as well as changes and information to appear in AMC will follow procedures defined ATS Messaging Management Manual and related appendix A (see ref 4).

Prior to introduction of the user addresses in AMC, all SITA users are requested to provide a valid AFTN address by contacting its local ANSP. The location and designator parts of the address are checked by SITA provisioning using ICAO related documents – Doc 7910 and Doc 8585. The internally validated address will be then introduced in AMC to follow the related procedure in relation with AIRAC cycle to go through data entry, data validation by the address assigning ANSP and acknowledgement prior to its processing, retrieval and use by SITA and SITA user.



5. AMHS Migration Tentative Plan

5.1. **AMHS Migration in ICAO EUR Region**

- At the end of 2015 the AMHS connection and Inter-Operability Testing (IOT) are completed with Switzerland, Germany and under test with Russia. The Pre-Operational Testing (POT) should start in January 2016 with Switzerland and Germany. It is envisaged to introduce the list of SITA users addresses in AMC in February 2016 for use in March 2016 for progressive commissioning and migration of current AFTN traffic to AMHS. The AMHS connection with France is envisaged and expected to start connection tests early 2016.

5.2. **AMHS Migration in ICAO APAC Region**

- At the end of 2015 the AMHS connection, Inter-Operability Testing (IOT) as well as Pre-Operational Testing (POT) are completed with Thailand. AMHS commissioning and migration steps are to be defined early 2016.
- Initial contacts are also made with Singapore and Australia. However the network and AMHS testing needs to be planned early 2016.

5.3. **AMHS Migration in ICAO NAM region**

- IOT document preparation is initiated. Network connectivity, IOT, POT, commissioning and migration steps are to be defined.

5.4. **AMHS Migration in ICAO MID region**

- IOT document is under completion with Jordan. Network connectivity, IOT, POT, commissioning and migration steps are to be defined. Contact with Qatar is also initiated pending updates to the proposed draft IOT document.

5.5. **AMHS Migration in ICAO SAM region**

- IOT document is under completion with Brazil. Network connectivity, IOT, POT, commissioning and migration steps are to be defined.

5.6. **AMHS Migration in ICAO AFI region**

- Contact is initiated with South Africa. Initial connection preparations are to be defined.

6. References



- 1- ICAO Doc 7910, Location Indicators
- 2- ICAO Doc 8585, Designators for Aircraft Operating Agencies, Aeronautical Authorities and Services
- 3- EUR Doc 020 – EUR AMHS Manual, including Appendices A - G
- 4- EUR Doc 021 – ATS Messaging Management Manual
- 5- EUR Doc 027 (Provisional) – IP Infrastructure Test Guidelines for EUR AMHS
- 6- EUR AMHS Documentation – AMHS/SITA Type X Interconnexion Architecture, Version 2.0

APPENDIX 4F

MID-AFS

Contingency Plan Contents

- Introduction
- Why this document
- Define the problem
- Executive summary
- Contingency States contacts
- Proposed Solutions/Actions

AFS Contingency Arrangements

- Emergency Centers in States
- Email / Fax gateways
- Lines [Satellite connections (VSAT)]
- SITA connection in case of all lines fail
- Fax use Last option (in distress cases)
- Distress urgent and FPL and related messages during degraded level of services
- Letter of Agreement

References

- R1: ICAO Annex 11- Air Traffic Services – Attachment C
- R2: Reference Guide to EUROCONTROL Guidelines for Contingency Planning of Air Navigation Services, Edition 2, April 2009
- R3: EUROCONTROL Guidelines for Contingency Planning of Air Navigation Services, Edition 2, April 2009

APPENDIX 4G

MID IP NETWORK WORKSHOP RECOMMENDATIONS

- The Regional IP Network is to be named “Common aeRonautical VPN (CRV)” and be implemented under developed CRV framework as a priority.
- The benefits from implementation of the CRV could only be realized when majority of the States join the network. Accordingly, to maximize the benefits all MID States are urged to join the CRV.
- MID States are urged to conduct the Local CBA taking into consideration the safety assessment and provide all information to ICAO MID Regional Office by the end of February 2016.
- ICAO MID Regional Office to support the CBA and Safety assessment through teleconference with the focal points after receiving the Local CBA from the States by March 2016.
- The CRV will have to be interconnected with other Regional Networks (PENS, MEVA etc.).
- The APAC and MID Region to establish their own CRV Operational Groups to manage the CRV in their Regions.
- One Interregional OG Meeting Co-chaired by both Regions is conducted once a year and/or when needed.
- The CRV framework to consider in the design two regional networks with one service provider for both APAC and MID Regions, to the extent possible.

APPENDIX 4H

MID IP Network Project
Replies to State Letter: AN 6/31.4-15/312

State	Name/Title	Contact Details (Tel./Fax/Mobile/Email)	IP Network equipment room Coordinates	Commitment/No of Location
Bahrain	Mohamed Ali Saleh Chief Aeronautical Telecomm	Fax: +973 17329966 Tel: +973 17321187 Email: masaleh@caa.gov.bh	Air Navigation Directorate Building: 353, Road: 2408, Block:224 Muharraq Bahrain	Y (1)
	Yaseen Hassan AlSayed Head Aeronautical Telecomm Network	Fax: +973 17329966 Tel: +973 17321183 Email: y.alsayed@caa.gov.bh	Technical Room coordination point: 2616N 05038E	
Egypt	Mr. Mohamed Ramzy Mohamed Abdallah Director of AFTN/AMHS Technical Department	Tel: +202 22657981 +201007736780 Email: Mrma_eg@yahoo.com	Building Name: Cairo Air Navigation Center (CANC) Address: NANSCE Company – Cairo	
	Eng. Haitham Mohamed Ahmed Eldosoki Director of AIM Technical Department	Tel: +202 22650781 +201007810781 Email: Haitham.mohamed@nansceg.net	30° 07' 01.0" N + 31°23'42.4" E	
Iran	Mr. AliAkbar SalehiValojerdi Senior Expert of IRANAFTN/AMHS Training Department	Fax: +98 21 66025101 Tel: +98 21 6102337 Mobile: +989 124 202775 Email: aasalehi@airport.ir		Y (1)
	Mr. Alireza Mahdavisefat Senior Expert of IRANAFTN/AMHS COM Centre	Fax: +98 21 66025101 Tel: +98 21 6314 6432 Mobile: +989 333510320 Email: mahdavi@airport.ir		
Iraq				
Jordan	Ms. Mona Ribhi AlNaddaf	Tel: +9626 4881473 +96279 9876710 Email: m.al-nadaf@carc.gov.jo		Y (1)
Kuwait	Mr. Hassan Alattar Communication Engineer	Fax: +965-2 4721 279 Tel: +965-2 4732 530 Mobile: +965 99449454 Email: ha.alattar@dgca.gov.kw		

State	Name/Title	Contact Details (Tel./Fax/Mobile/Email)	IP Network equipment room Coordinates	Commitment/ No of Location
Lebanon	Mr. Mohamad Abdallah Saad Head of Telecommunication Equipment	Lebanese Directorate General of Civil Aviation Fax: +961 1 629 031 Tel: +961 1 628 151 Mobile: +961 3 280 299 Email: msaad@beirutairport.gov.lb		
Libya				
Oman				
Qatar				
Saudi Arabia	Ibrahim bash Senior Systems Engineer Automation Engineering Branch	Fax: +966 12 671 9041 Tel: +966 12 671 7717 Ext 1119 Mobile: +966 50 567 1231 Email: ibasheikh@gaca.gov.sa		(3 sites) (Riyadh, Jeddah and Dammam)
Sudan	Eng. Yasir Eltayeb Sidahmed	Fax: +249 183 770001 Tel: +249 183 782701 Email: yasirts@gmail.com		
Syria				
UAE	Greg Kurten A/Director CNS Communication, Navigation and Surveillance	Fax: +971 2 599 6872 Tel: +971 2 599 6860 Email: gegkurten@szc.gcaa.ae	The co-ordinates are as follows: 24° 26' 41.82" N 54° 36' 35.46" E	
	Shahzad Chaudhary Senior CNS Engineer Communication, Navigation and Surveillance	Fax: +971 2 599 6872 Tel: +971 2 599 6865 Email: shahzad@szc.gcaa.ae	The working number at site is 00971 2 5996900	
Yemen				



MIDAMC User Manual

Author:	MIDAMC STG
Version:	V2.0
Date:	9/2/2016



Table of contents

1. Introduction.....	4
1.1 Scope of Document.....	4
1.2 MIDAMC Project.....	4
1.3 MIDAMC Steering Group.....	4
2. General Requirements.....	5
2.1 User Types.....	6
2.2 MIDAMC Operator.....	6
2.3 Users Registration.....	7
2.4 Users Accreditation Procedure.....	9
2.5 Windows Structure.....	12
3. MIDAMC Functions.....	13
3.1 AMF-O Functions.....	13
3.2 Network Inventory.....	15
3.2.1 Persons & contacts.....	16
3.2.2 COM Center.....	17
3.2.3 AFTN/CIDIN.....	18
3.2.4 AMHS Capabilities.....	19
3.2.5 Connections.....	23
3.2.6 The tasks cycle at Network Inventory.....	25
3.3 Address Management.....	25
3.3.1 Address Change.....	29
A) Major Changes.....	29
B) Minor Changes.....	30
3.4 Routing Management.....	31
3.4.1 AFTN Routing.....	32
3.4.2 AMHS Routing.....	32
3.4.3 CIDIN Routing.....	33
3.5 User Capabilities Management.....	34
3.6 MIDAMC Miscellaneous Functions.....	35
3.6.1 Support Function.....	36
3.6.2 View Bulletin Board.....	37



MIDAMC User Manual



3.6.3 View AIRAC Cycle.....	38
3.6.4 AMC Operator Details.....	39
3.6.5 Path Function.....	40
3.6.6 Convert AFTN Address.....	41
3.6.7 Region.....	42
3.6.8 Send email to User Group.....	43
4.AMF-I Functions	44
4.1 AMHS MD Contact.....	44
4.2 AMHS Implementation Plan.....	44
4.3 Helpdesk Function.....	45
References List.....	46



1. Introduction

1.1 Scope of the Document

This Document is MIDAMC User Manual, developed to guide users in the MID Region to use the MIDAMC. The document developed by the ICAO MIDAMC Steering Group.

1.2 MIDAMC Project

MID COM Centers participate in EUR-AMC as external COM operators that have access to some of the operational functions, but they can't use an important function like routing management which is currently available to EUR COM Centers.

The Aeronautical fixed telecommunication network in the MID Region has some operational issues like Asymmetric routes which can cause message loss. The Routing function can integrate AMHS routing with AFTN/CIDIN routing, and ensure optimal consistent routes. The MID region decided to develop their own AMC, the project sponsored by Jordan.

The Goals of the project are:

- To facilitate transition from AFTN/CIDIN to AMHS.
- To support states with AMHS in operation or on their way to implement.
- To provide Routing management function that can ensure optimum consistent routes.
- To provide an electronic tool to keep ANP FASID data up-to-date.

1.3 MIDAMC Steering Group (MIDAMC STG)

The Fourteenth meeting of the Regional Air Navigation planning and Implementation group (MIDANPIRG/14) decided to establish the MIDAMC steering committee,

- **DECISION 14/20: ESTABLISHMENT OF MID-AMC STEERING GROUP**

That,

- a) a MID-AMC Steering Group is established with TOR as at Appendix 4.5A to the [MIDANPIRG/14 Report](#) on Agenda Item 4.5; and
- b) States appoint a Member and Alternate for the MID-AMC Steering Group.

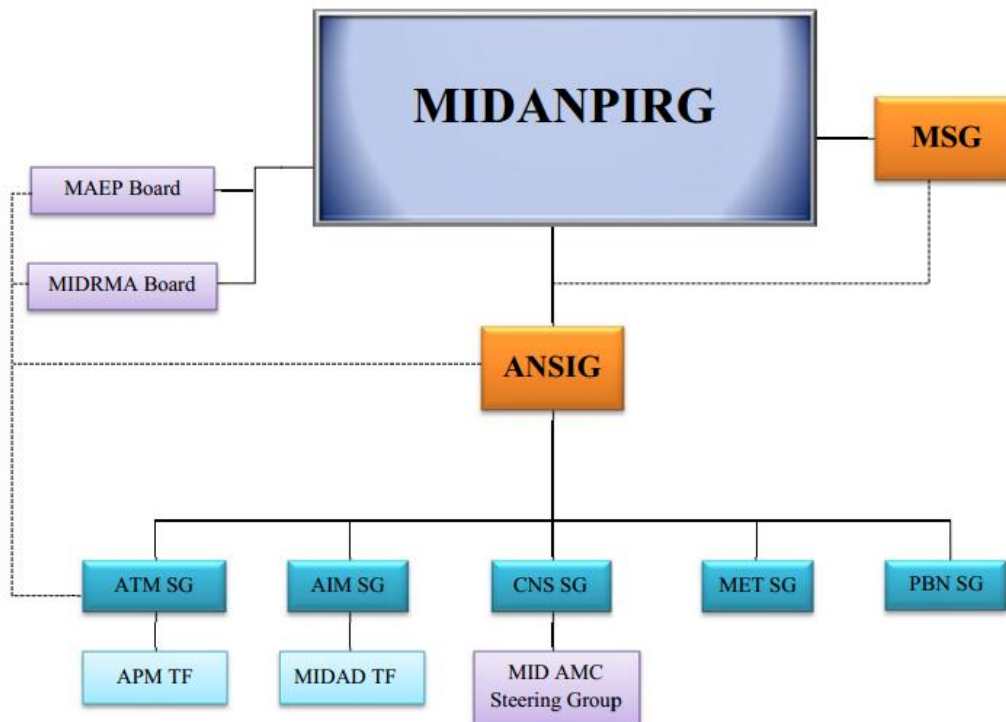

2. General Requirements

2.1 Users Types

The MIDAMC User types are as in the European AMC

- AMF-I Users
- CCC Operators (Co-operating COM Centre)
- External COM Centres
- Read-Only Users
- Participating COM Centres

➤ Non-Participating COM Centres

The Access to AMC functions by each user category as in the following table

AMC functions user categories	AMF-I functions	AMF-O functions	AMC Operator functions
AMC Operator	yes	yes	yes
CCC Operators	yes	yes	no
External COM Operators	yes	access to some functions	no
AMF-I Users	yes	read-only access to some functions	no
Read/Only Users	read-only access to some functions	read-only access to some functions	no
Participating COM Centres	indirect access to some functions through AMC Operator	indirect access to some functions through AMC Operator	no

Table 2: Status of participants in ATS Messaging Management

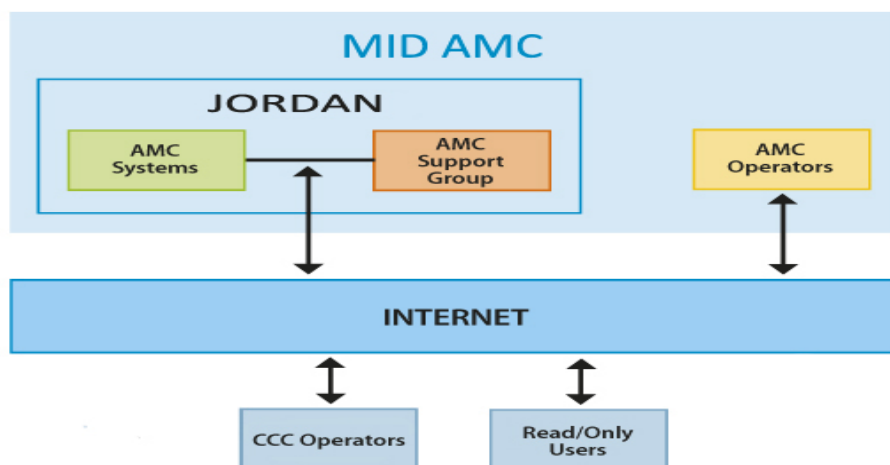

2.2 MIDAMC Operator



MIDAMC User Manual



The MIDAMC Operator is responsible for overall operation of the AMC and of associated procedures. Currently four AMC Operators are selected from Jordan. The team performs several Functions including a high number of functions which are not visible to any other user category

❑ The main functions of AMC Operator are :

1. Manages the overall operation of MID AMC.
2. Acts as a Regional Focal point on the European AMC.
3. Creates access accounts according to regional procedures.
4. Collecting & analyzing ATS messaging data received from MID states as well as from European AMC.

2.3 Users Registration

New User should register on the MIDAMC to create a login access, user should visit www.midamc.jo

Welcome to MID AMC Website, in order to use MID AMC online services you need the Login ID and Password that you have chosen during self-registration. After this login process you will be given the opportunity to access the service(s) for which you have been granted the access right .If you wish to access MID AMC for the first time, please use the [self-registration form](#) you which you can find here. Please send any question regarding the MID AMC website to the Support unit: midamc@carc.gov.jo

Login ID

Password

[Forgotten UserID or Password](#)

After selecting the "Register for MID AMC", a registration form open as following:

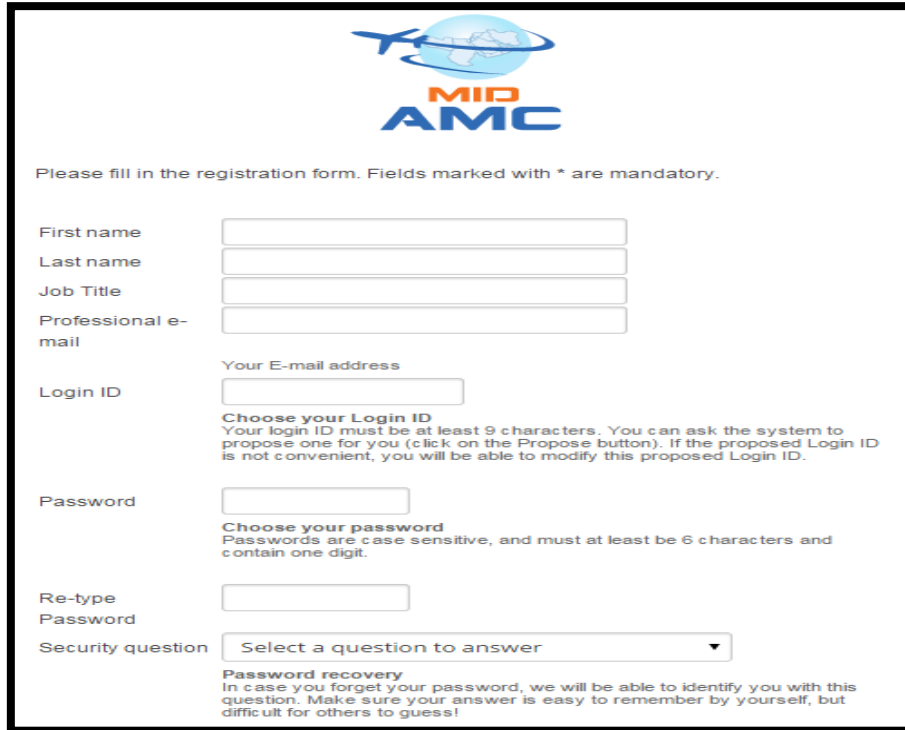

MID AMC

Please fill in the registration form. Fields marked with * are mandatory.

First name

Last name

Job Title

Professional e-mail

Your E-mail address

Login ID

Choose your Login ID
Your login ID must be at least 9 characters. You can ask the system to propose one for you (click on the Propose button). If the proposed Login ID is not convenient, you will be able to modify this proposed Login ID.

Password

Choose your password
Passwords are case sensitive, and must at least be 6 characters and contain one digit.

Re-type Password

Security question

Password recovery
In case you forget your password, we will be able to identify you with this question. Make sure your answer is easy to remember by yourself, but difficult for others to guess!

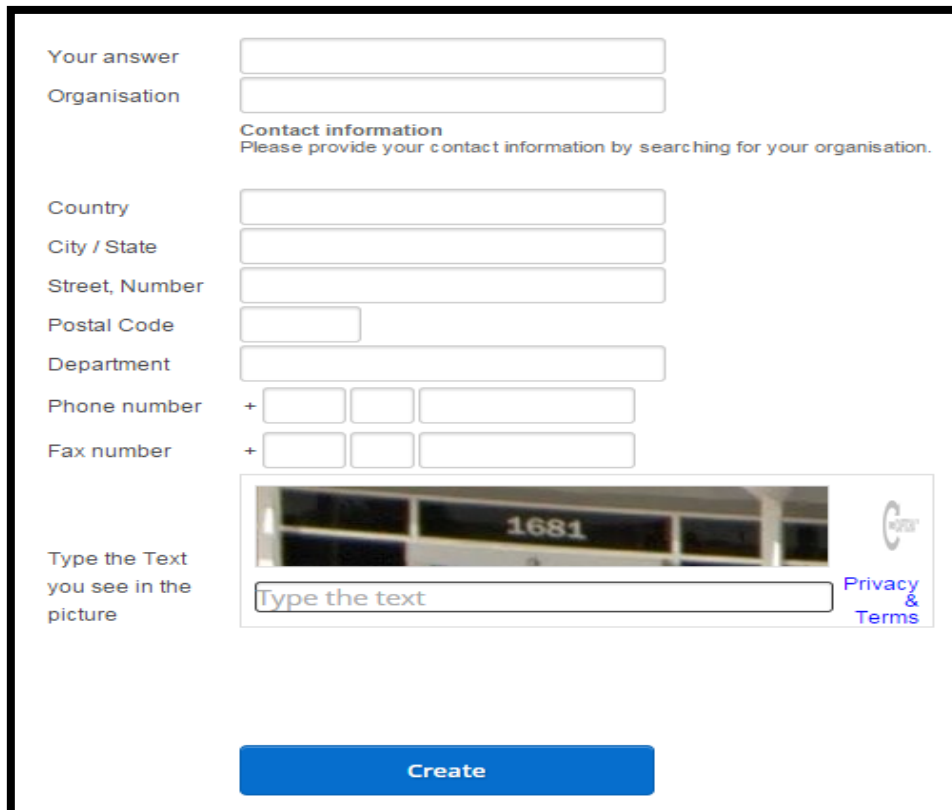

Your answer

Organisation

Contact information
Please provide your contact information by searching for your organisation.

Country

City / State

Street, Number



Postal Code

Department

Phone number +

Fax number +

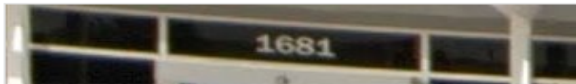
Type the Text you see in the picture

[Privacy & Terms](#)

Create

After filling the required information successfully, the following message will appear:

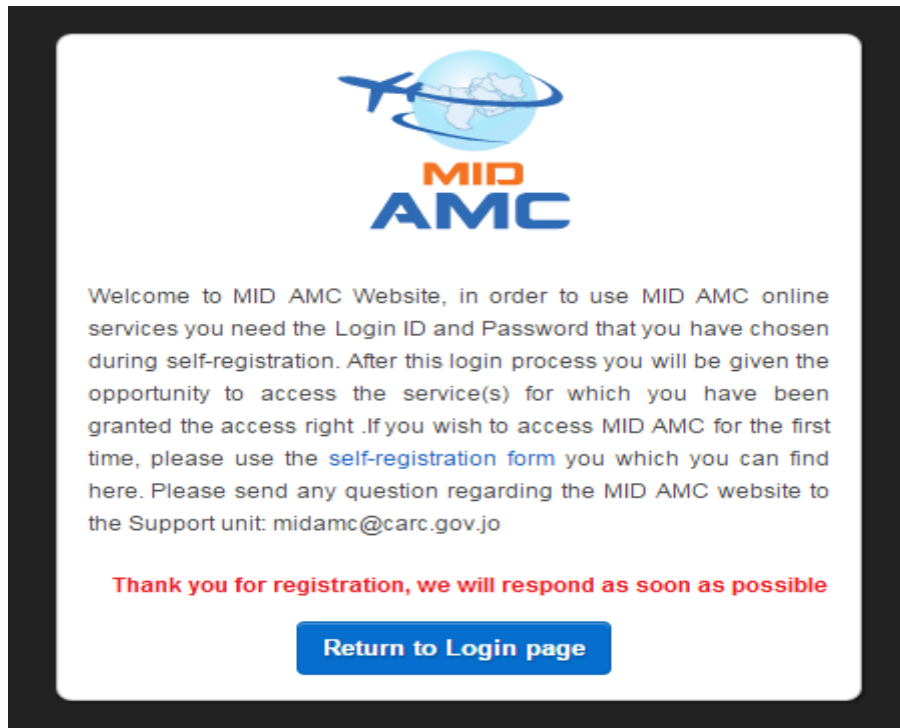

2.4 Users Accreditation Procedure

There are three Four MID-AMC user types:

- 1) Operator which is equivalent to AMC Operator
- 2) User which is equivalent to AMC CCC Operator
- 3) Read-Only User which is equivalent to AMC Read-Only.
- 4) External MID AMC User

To guarantee the confidentiality and integrity of data contained in the MID-AMC database, it is necessary to grant access rights of a given user category only to people who are duly identified and have the right to view and/or modify such data. This process is called accreditation of users, which is defined hereafter for the accreditation of a user in each category:

- 1) AMC External Operators on European AMC of the MID Region:
1-1 MID-AMC Operator transferred those users to MID-AMC as MID-AMC Users.



MIDAMC User Manual

1-2 AMC External operator to register online on MID-AMC website at www.midamc.jo

2) New MID-AMC Users:

2-1 State to send letter (email) to ICAO MID Regional Office to designate a new MID-AMC User.

2-2 New MID-AMC User to register online on MID-AMC website at www.midamc.jo

2-3 MID-AMC Operator coordinate with ICAO MID Office to approve the request in (2-2)

3) AMC Read-Only Users on European AMC of the MID Region:

3-1 MID-AMC Operator transferred those users to MID-AMC as MID-AMC Read-only Users.

3-2 AMC Read-only users to register online on MID AMC website at www.midamc.jo

4) New MID-AMC Read-only User:

4-1 New MID-AMC Read-Only User to register online on MID AMC website at www.midamc.jo

4-2 MID-AMC Operator coordinate with the MID AMC User of the corresponding COM center (if any) Or with the ICAO MID office to approve the request in (4-1).

5) External MID AMC User: Users from outside MID Region and act as either CCC on EUR AMC or External AMC user can register on the MID AMC as MID AMC User:

5-1 register online at www.midamc.jo

5-2 MID AMC Operator check the registration on EUR AMC to validate the registration



MIDAMC User Manual



The MID Email Domains List is as in the following table

Bahrain: Ministry of transportation	@mot.gov.bh
Egypt: Ministry of Civil Aviation	@civilaviation.gov.eg
Iran: Civil Aviation Organization	@cao.ir
Iraq: Iraqi Civil Aviation Authority	@iraqcaa.com
Jordan: Civil Aviation Regulatory Commission	@carc.gov.jo
Kuwait: Directorate General of Civil Aviation	@dgca.gov.kw
Lebanon: Lebanese Civil Aviation Authority	@lebcaa.com
Libya: Libyan Civil Aviation Authority	@caa.ly
Qatar: Civil Aviation Authority	@caa.gov.qa
Saudi: General Authority of civil Aviation	@gaca.gov.sa
Sudan: Civil Aviation Authority	@scaa.gov.sd
Syria: Syrian Civil Aviation Authority	@scaa.sy
UAE: General Civil Aviation Authority	@gcaa.gov.ae
Yemen: Civil Aviation and Metrological Authority	@camayemen.com

2.5 Windows Structure

Three Menus in the main page of the MIDAMC; Main Window, Function Menu and Sub-Functions (tabs)



>> AMC Application - MID Region

There are currently 4 User(s) request

Network Inventory

Persons & Contacts	Com Centres	AFTN / CIDIN Capabilities	AMHS Capabilities
Region	COM Centre	Location	Country
MID	OJAM	AMMAN/MARKA	Jordan
MD Common Name		Country-Name	ADMD-Name
OJ		XX	ICAO

Personal Role	Firstname	Surname
Technical Supervisor	Yaser	ziad
AMC Operator	Maisoon	OWENAH
Head of Technical Department	Muna	ALNADAF
AMC Operator	Majdolin	AL-Trad

REPORT

**Menu
(Functions)**

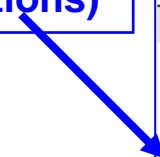

View Operational Data

- ▶ Network Inventory
- ▶ Routing Directory
- ▶ Address Management
- ▶ User Capabilities Management
- ▶ Static Report
- ▶ COM Charts

View Pre-Operational Data

- ▶ Network Inventory
- ▶ Routing Directory and ACK
- ▶ Address Management
- ▶ User Capabilities Management
- ▶ Static Report (updated data)

Enter Background Data

- ▶ Network Inventory
- ▶ Address Management
- ▶ User Capabilities Management

Miscellaneous Functions

- ▶ Support Functions
- ▶ View Bulletin Board
- ▶ View AIRAC Cycle
- ▶ AMC Operator Details
- ▶ Path Function
- ▶ Convert AFTN Address
- ▶ Regions
- ▶ Send E-Mail to User Groups

Manage Background Data

The Screen areas of main window as the following figure

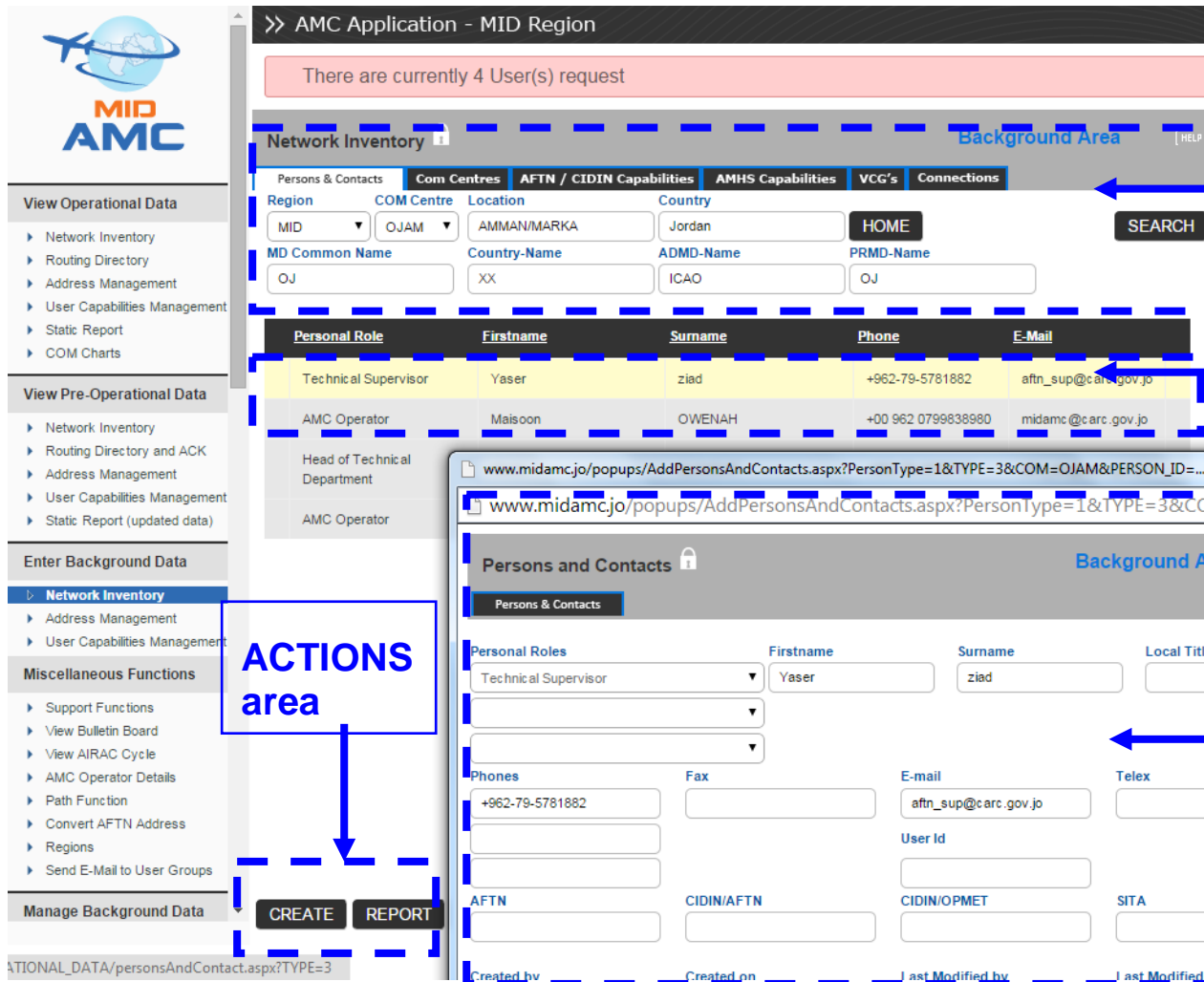

Network Inventory

There are currently 4 User(s) request

Persons & Contacts | Com Centres | AFTN / CIDIN Capabilities | AMHS Capabilities | VCG's | Connections

Region: MID | COM Centre: OJAM | Location: AMMAN/MARKA | Country: Jordan

MD Common Name: OJ | Country-Name: XX | ADMD-Name: ICAO | PRMD-Name: OJ

Personal Role	Firstname	Surname	Phone	E-Mail
Technical Supervisor	Yaser	ziad	+962-79-5781882	aftn_sup@arc.gov.jo
AMC Operator	Maisoon	OWENAH	+00 962 0799838980	midamc@arc.gov.jo
Head of Technical Department				
AMC Operator				

ACTIONS area

CREATE REPORT

Persons and Contacts

Personal Roles: Technical Supervisor

Firstname: Yaser | Surname: ziad

Phones: +962-79-5781882

E-mail: aftn_sup@arc.gov.jo

AFTN: | CIDIN/AFTN: | CIDIN/OPMET: | SITA: |

The Management of Access Rights at menu level not the same groups of functions are visible for each category, while at window level:

- sub-functions can be hidden depending on user category
- buttons are enabled / disabled
- data are enabled / disabled

3. MIDAMC Functions

There are two main function type at the MIDAMC Implementation Support Functions (AMF-I) and Operational Functions (AMF-O). The AMF-I functions like AMHS MD contacts, AMHS Implementation



MIDAMC User Manual



planning, Inter-working Test Support and Helpdesk Functions. While the AMF-O are Network inventory, Routing management, Address management, AMHS user capabilities management and Miscellaneous functions

MIDAMC Functions do not need to be executed in a short time period. These relate to medium and long-term requirements. The current implementation of ATS Messaging Management includes only off-line management functions. On-line functions may be designed and implemented in the future.

3.1 AMF-O Functions

Information is structured in three data areas:

- The Operational Data Area
- The Pre-Operational Data Area
- The Background Data Area

The Background Data Area is the working area of the CCC operators

purpose	working area (CCC Operators and MIDAMC Operators)
access	restricted to own COM Centre (except for MIDAMC Operator)
AMC Operator actions	validating Inventory, work on Routing Tables
functions	data entry and validation

The Pre-operational Data Area represents the planned operational state



MIDAMC User Manual



purpose	represent planned operational state
access	read (all), routing acknowledgement (restricted)
AMC Operator actions	transfers COM centre information, propose Routing Tables
Functions	retrieval, all functions, routing acknowledgement

The Operational area represents the operational state

purpose	represent operational state
access	read (all)
AMC Operator actions	copied as whole from Pre-operational
functions	retrieval, all functions

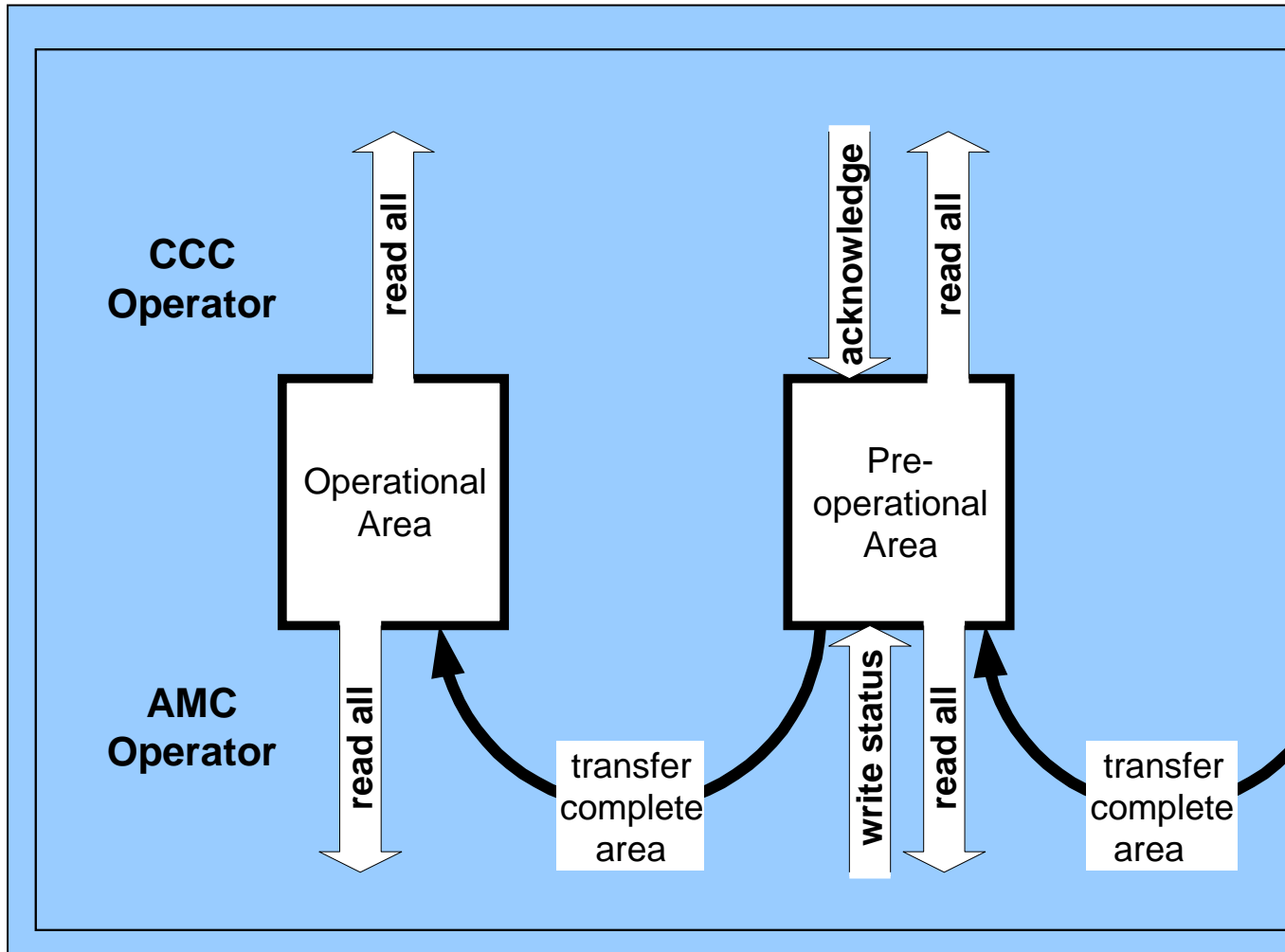

3-2 Network Inventory Function

The Network Inventory enables to enter descriptive data about COM centers, and includes five (5) sub-functions:



The Person &Contacts sub-function enables to enter data related to a person or contact associated to the considered COM Centre. The main screen shows a table with the full list of persons/contacts, and summary information for each person/contact. A record in this table can be

selected by clicking on any field to enter the Details mode and open the associated pop-up window. The following figure shows this sub-function.

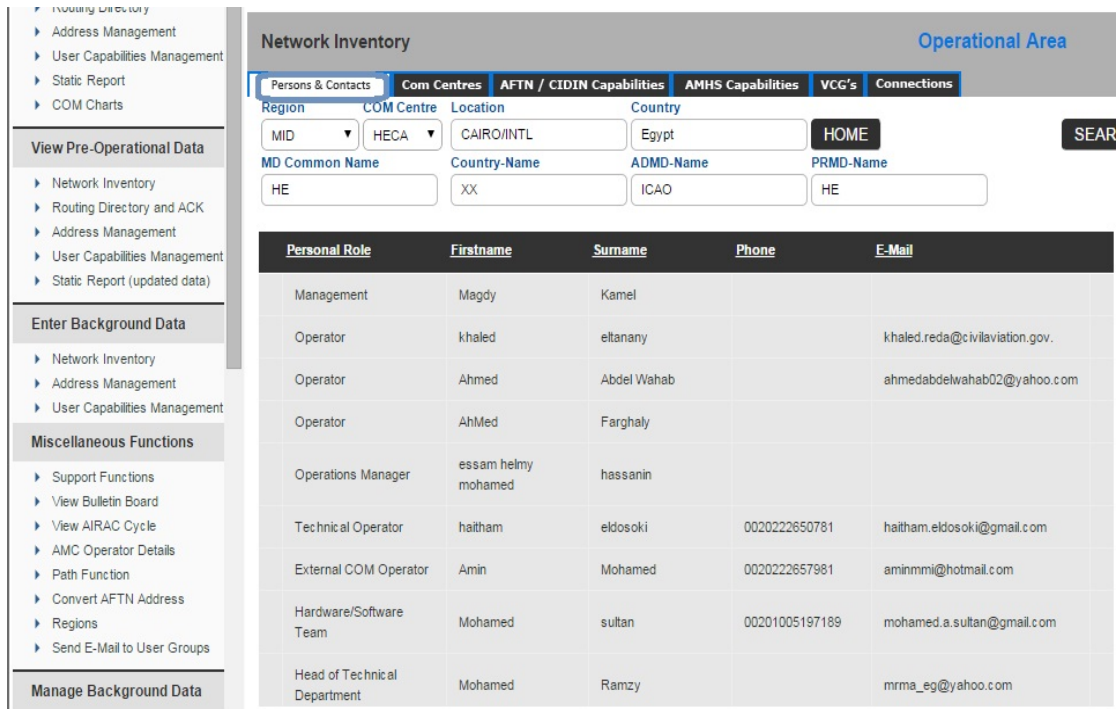

Network Inventory Operational Area

Persons & Contacts | Com Centres | AFTN / CIDIN Capabilities | AMHS Capabilities | VCG's | Connections

Region: MID | COM Centre: HECA | Location: CAIRO/INTL | Country: Egypt | HOME | SEARCH

MD Common Name: HE | Country-Name: XX | ADMD-Name: ICAO | PRMD-Name: HE

Personal Role	Firstname	Surname	Phone	E-Mail
Management	Magdy	Kamel		
Operator	khaled	eltanany		khaled.reda@civilaviation.gov.
Operator	Ahmed	Abdel Wahab		ahmedabdelwahab02@yahoo.com
Operator	AhMed	Farghaly		
Operations Manager	essam helmy mohamed	hassanin		
Technical Operator	haitham	eldosoki	0020222650781	haitham.eldosoki@gmail.com
External COM Operator	Amin	Mohamed	0020222657981	aminmmi@hotmail.com
Hardware/Software Team	Mohamed	sultan	00201005197189	mohamed.a.sultan@gmail.com
Head of Technical Department	Mohamed	Ramzy		mrma_eg@yahoo.com

3-2-1 Persons & contacts

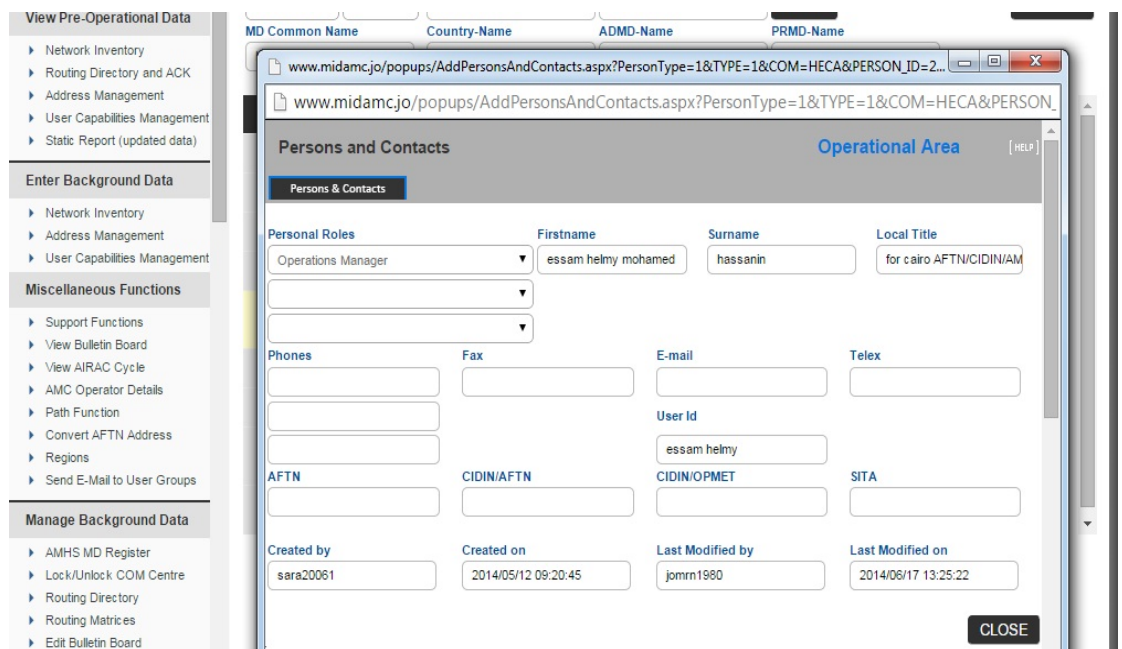

www.midamcjo/popups/AddPersonsAndContacts.aspx?PersonType=1&TYPE=1&COM=HECA&PERSON_ID=2..

www.midamcjo/popups/AddPersonsAndContacts.aspx?PersonType=1&TYPE=1&COM=HECA&PERSON...

Persons and Contacts Operational Area [HELP]

Persons & Contacts

Personal Roles: Operations Manager | Firstname: essam helmy mohamed | Surname: hassanin | Local Title: for cairo AFTN/CIDIN/AM

Phones: | Fax: | E-mail: | Telex: | User Id: essam helmy

AFTN: | CIDIN/AFTN: | CIDIN/OPMET: | SITA: | Created by: sara20061 | Created on: 2014/05/12 09:20:45 | Last Modified by: jomrn1980 | Last Modified on: 2014/06/17 13:25:22

CLOSE



MIDAMC User Manual



The Popup Menu Data Elements are Personal Role, first name, surname, local title, phones, Fax, Email, Telex, Userid.

Personal Role	contains the personal role of the person or contact, according to a pre-defined categorisation of generic roles
First Name	Can be empty.
Surname	Can be empty.
Local title	the title/function of the person or contact, as defined in his/her organisation
Phones	Phone number of the person or contact
Fax	Fax number of the person or contact
E-Mail	E-Mail address of the person or contact
Telex	. telex number of the person or contact
User ID	User ID for persons who have access to the AMC
AFTN Address	AFTN address indicator of the person or contact
SITA	SITA Type B messaging address of the person or contact.
Remark	a free text field for additional information, if needed

3.2.2 COM Center sub-function provides general information about the COM Centre. like

- *Administrative status (Internal or External)*
- *Postal address*
- *Remark*
- *Application (s):*

A table includes the list of applications supported by the COM Centre (ATS Message Server, AFTN/AMHS Gateway, Conventional AFTN, CIDIN/AFTN, ...)

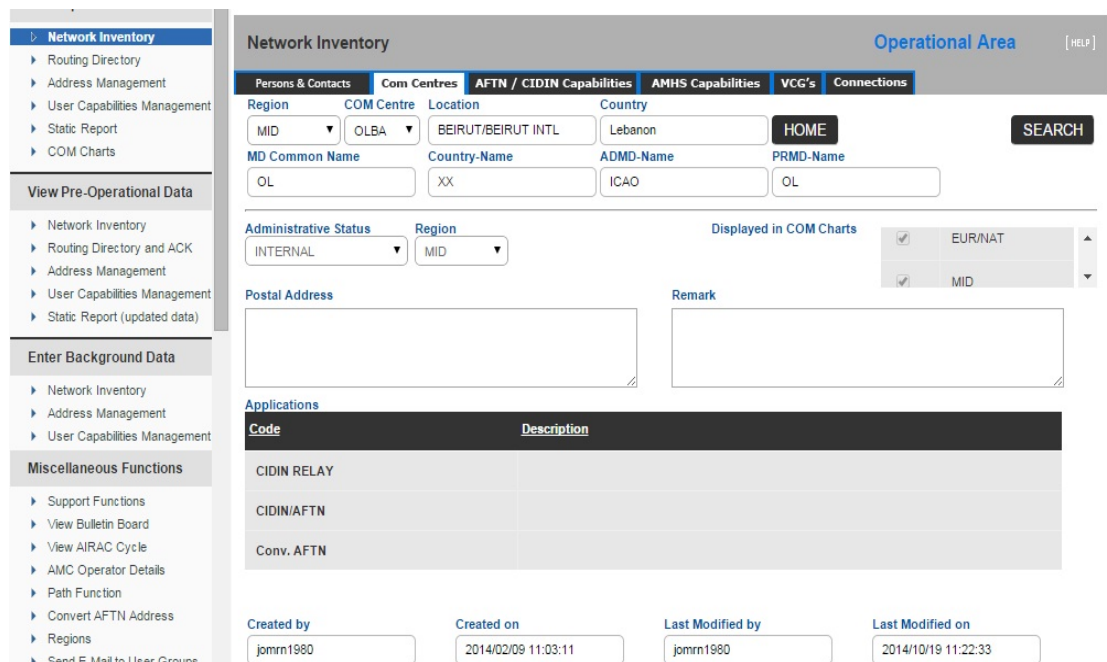

The screenshot shows the 'Network Inventory' web interface. The main content area is titled 'Network Inventory' and includes a navigation menu on the left and a search bar on the right. The main content is divided into several sections:

- Operational Area:** Includes tabs for 'Persons & Contacts', 'Com Centres', 'AFTN / CIDIN Capabilities', 'AMHS Capabilities', 'VCG's', and 'Connections'. The 'Com Centres' tab is active.
- Search and Filter:** Fields for 'Region' (MID), 'COM Centre' (OLBA), 'Location' (BEIRUT/BEIRUT INTL), and 'Country' (Lebanon). Includes a 'HOME' button and a 'SEARCH' button.
- MD Common Name:** Fields for 'MD Common Name' (OL), 'Country-Name' (XX), 'ADMD-Name' (ICAO), and 'PRMD-Name' (OL).
- Administrative Status:** A dropdown menu set to 'INTERNAL'. A 'Region' dropdown is set to 'MID'. A 'Displayed in COM Charts' section has checkboxes for 'EUR/NAT' and 'MID', both checked.
- Postal Address:** A large text input field.
- Remark:** A large text input field.
- Applications:** A table with columns 'Code' and 'Description'.

Code	Description
CIDIN RELAY	
CIDIN/AFTN	
Conv. AFTN	
- Metadata:** Fields for 'Created by' (jommm1980), 'Created on' (2014/02/09 11:03:11), 'Last Modified by' (jommm1980), and 'Last Modified on' (2014/10/19 11:22:33).

3.2.3 AFTN/CIDIN Capabilities sub-function describes the AFTN and CIDIN capabilities of the COM Centre



MIDAMC User Manual



- Network Inventory
 - Routing Directory
 - Address Management
 - User Capabilities Management
 - Static Report
 - COM Charts
- View Pre-Operational Data
 - Network Inventory
 - Routing Directory and ACK
 - Address Management
 - User Capabilities Management
 - Static Report (updated data)
- Enter Background Data
 - Network Inventory
 - Address Management
 - User Capabilities Management
- Miscellaneous Functions
 - Support Functions
 - View Bulletin Board
 - View AIRAC Cycle
 - AMC Operator Details
 - Path Function
 - Convert AFTN Address
 - Regions
 - Send E-Mail to User Groups

Network Inventory
Operational Area [HELP]

Persons & Contacts
Com Centres
AFTN / CIDIN Capabilities
AMHS Capabilities
VCG's
Connections

Region: MID
 MD Common Name: OB

COM Centre: OBBI

Location: BAHRAIN INTERNATIONAL
 Country-Name: Kingdom of Bahrain

Country: Kingdom of Bahrain

HOME

SEARCH

Ad - Ax Mapping Capability
 Ad - Ax Mapping Actual Used

Ad - Ax Mapping Capability
 Ad - Ax Mapping Actual Used

CIDIN App. Windowing Capability
 CIDIN App. Win. Actual Value

Long Message Processing

CIDIN Addresses

Code	Address
AFTN Ae/Ax	OBBI
AFTN OPM/NM	OBBI

Created by: jomrn1980

Created on: 2014/07/02 13:19:36

Last Modified by: jomrn1980

Last Modified on: 2014/09/10 14:47:58

REPORT

3.2.4 AMHS Capabilities Sub-function enables the MID AMC user to enter data related to the AMHS capabilities of his COM Centre. Data includes:

- 1- Capabilities of the ATS Message Server
- 2- Capabilities of the AFTN/AMHS Gateway

ATS Message Server	If Ticked: ATS Message server present and active Not ticked: Not present OR not Active
MTA Name	X.400 MTA Name
Maximum Content Length	Maximum length (in bytes) of messages that the MTA is capable to accept, transfer and deliver. EUR recommendation should be at least 2 M
Message Lifetime	Duration during which the MTA will try to transfer before assuming transfer failure and generating NDR

Extended Information Types (EITs) in support of Encoded Message Encodings that the MTA is capable to transfer to accept, transfer and deliver checkbox (ticked = yes, un-ticked = no) for each body part / encoding combination specified in Doc 9880 – part 2 (4.5.2.1.4)

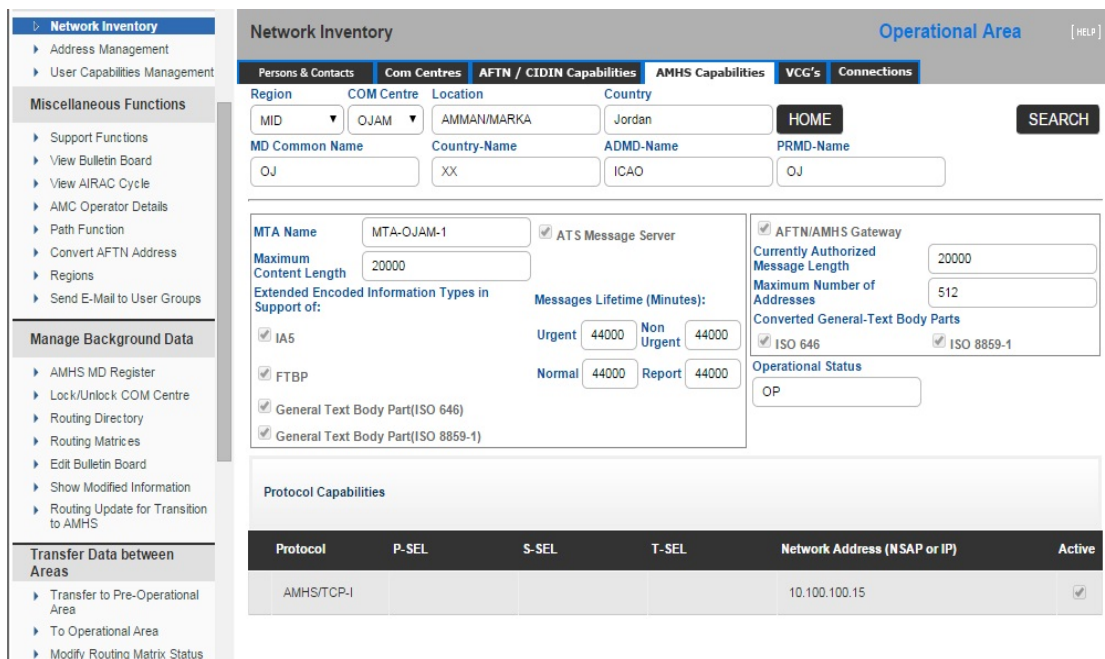

ATS Message Server Frame

ATS Message Server	If Ticked: ATS Message server present and active Not ticked: Not present OR not Active
MTA Name	X.400 MTA Name
Maximum Content Length	Maximum length (in bytes) of messages that the MTA is capable to accept, transfer and deliver. EUR recommendation should be at least 2 M
Message Lifetime	Duration during which the MTA will try to transfer before assuming transfer failure and generating NDR
Extended Encoded	Message Encodings that the MTA is capable to transfer to accept, transfer and deliver



MIDAMC User Manual



Information Types (EITs) in support of	checkbox (ticked = yes, un-ticked = no) for each body part / encoding combination specified in Doc 9880 – part 2 (4.5.2.1.4)
--	--

AFTN/AMHS Gateway Frame

AFTN/AMHS Gateway	Derived from "applications" selected in the COM Centres function (not modifiable) If unticked the whole frame is disabled. a checkbox: ticked = present and active unticked = not present or not active
Currently Authorized Content Length Maximum	length (in bytes) of messages that the gateway will accept to convert to AFTN recommendation in EUR should be at least 2 Mbytes Maximum
Number of Recipients	The maximum number of recipients O/R addresses allowed in a message converted by the gateway. Messages with more recipients are rejected. Doc 9880 requirement is 512 recipients
Converted General-Text Body Parts	General-text body parts that the gateway is capable to convert to AFTN one checkbox (ticked = yes, un ticked = no) for each body part character set

The Operational Status indicate that the AMHS is operational in COM center Coming from the AMHS MD Register function (not modifiable), when you put the AMHS in operation, inform the MID AMC operator to change the status to “OP”



MIDAMC User Manual



MHS Capabilities VCG's Connections

HOME SEARCH

PRMD-Name
OJ

AFTN/AMHS Gateway
 AFTN/AMHS Gateway
 Currently Authorized Message Length: 20000
 Maximum Number of Addresses: 512
 Converted General-Text Body Parts
 ISO 646 ISO 8859-1

Operational Status

SEL	Network Address (NSAP or IP)	Active
	10.100.100.15	<input checked="" type="checkbox"/>

The Protocol Capabilities table made of six columns showing the protocols supported by the COM Centre for international connectivity, and the MTA configuration parameters associated with the network access, which are needed by Remote COM Centres to configure AMHS connections with the COM Centre. AMHS/IPS is the target Implementation in the MID Region

Protocol	Supported AMHS protocols for COM Centre to COM Centre communication. There can be various protocol stacks 'AMHS/TCP-IP' 'AMHS/ATN-TP4' 'AMHS/TP0-X.25'
P-SEL	Presentation selector for OSI Upper Layer stack



MIDAMC User Manual



S-SEL	Session selector for OSI Upper Layer stack
T-SEL	Transport selector for OSI Upper Layer stack
Network Address	The IP address or ATN NSAP
Active	Indicates the current operational status of the protocol stack a checkbox: ticked = active unticked = present but not yet active

3.2.5 Connections sub-function describes the Connections of all kinds, AFTN, CIDIN and AMHS, existing and planned between the COM Centre and remote COM Centres. it includes two tables (EXISTING & PLANNED)

The screenshot displays the 'Network Inventory' web application interface. The left sidebar contains a navigation menu with categories like 'Network Inventory', 'Miscellaneous Functions', 'Manage Background Data', and 'Transfer Data between Areas'. The main content area is titled 'Network Inventory' and includes a search bar with filters for Region (MID), COM Centre (OMAE), Location (EMIRATES FIR), and Country (United Arab Emirates). Below the search bar, there are input fields for MD Common Name (UAE), Country-Name (XX), ADMD-Name (ICAO), and PRMD-Name (UAE). The interface shows two tables: 'Existing Connections' and 'Planned Connections'. The 'Existing Connections' table lists three entries: OBBI (CIDIN PVC, 64 K capacity, active), OEJN (AMHS, Satellite link type, active), and OIII (CONV. AFTN, 9600 capacity, active). The 'Planned Connections' table shows one entry: OBBI (AMHS, 64K capacity, inactive, with a 'Change' event type).

Remote COM	Protocol	Network Address	Link Type	Capacity	Supplier	Active	Remark
OBBI	CIDIN PVC			64 K		<input checked="" type="checkbox"/>	
OEJN	AMHS		Satellite			<input checked="" type="checkbox"/>	
OIII	CONV. AFTN			9600		<input checked="" type="checkbox"/>	

Remote COM	Protocol	Network Address	Link Type	Capacity	Supplier	Active	Event Type
OBBI	AMHS			64K		<input type="checkbox"/>	Change

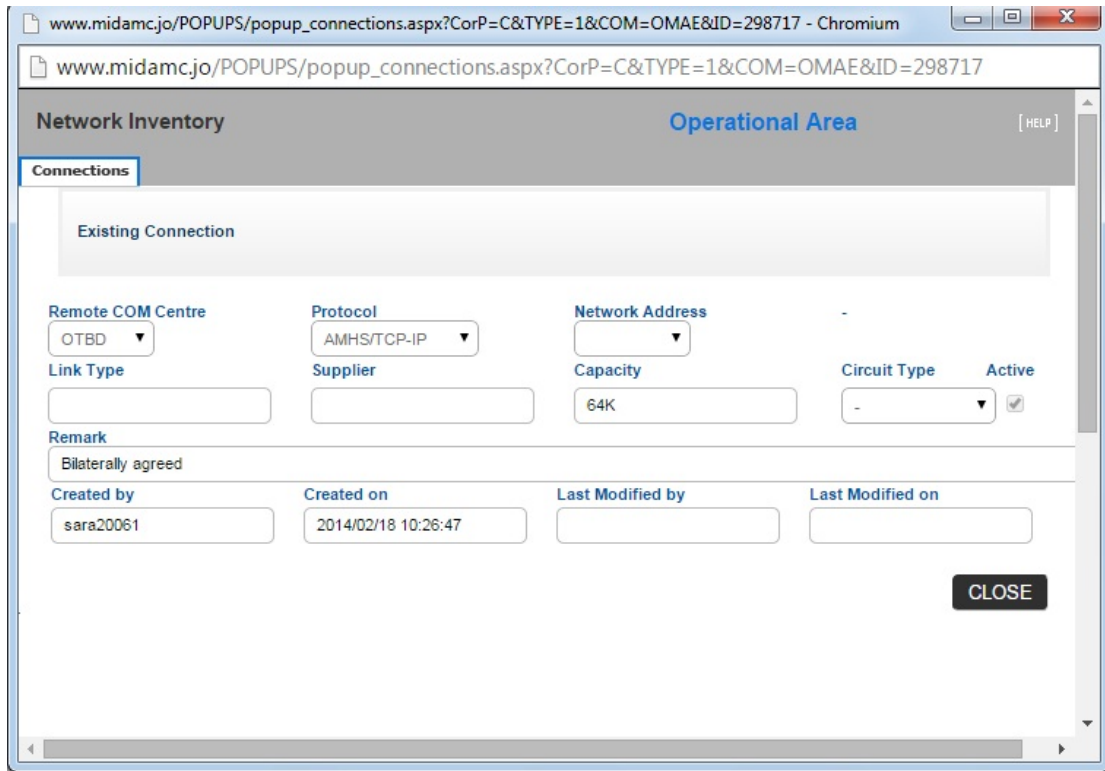

Remote COM	The "other end" of the connection, the COM Centre location indicator.
Protocol	protocol used over the connection, can be AMHS, AFTN, CIDIN,...etc
Network Address	The network address of the REMOTE Com Centre used for the connection
Link Type	Type an indication of the physical connectivity used for the connection
Capacity	The capacity of the link or circuit or of the network access value in kbits/s
Circuit type	The type of circuit supporting the connection, based on a standard ICAO classification 'L' (Landline), 'S' (Satellite)
Supplier	An indication of the supplier of physical connectivity used for the connection
Active	Active indicates the current operational status of the connection

a checkbox: ticked = active
unticked = present but not yet active

3.2.6 The tasks cycle at Network Inventory

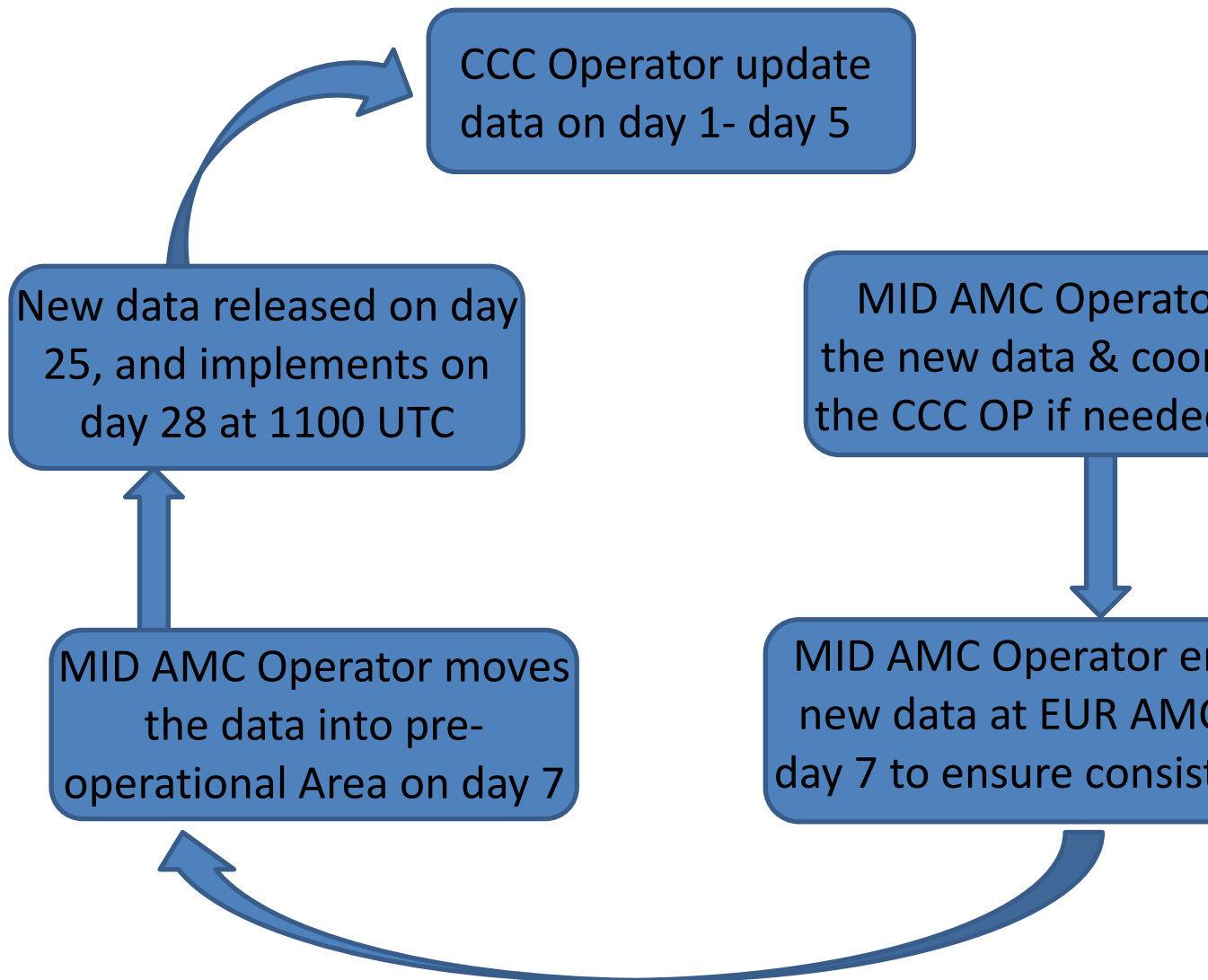

3.3 The Address Management

The Originator/ recipient address (O/R) is used to route messages, the high level attributes are used for Inter- domain routing, while the low level attributes are used for Intra- domain Routing. The use of wrong



MIDAMC User Manual



AMHS addresses may cause mis-routings and non-deliveries. Also, lack of synchronization in changes introduces wrong addresses.

AMHS Addressee are expected to change frequently during the transition period, AFTN and CIDIN are more static. At the AFTN/AMHS Gateway; where is a mixed environment, conversion from AFTN/CIDIN address to AMHS address needs up to date AMHS addressee information.

In the short- to medium-term, ICAO HQ will utilize the AMC and has urged the States to follow the procedures for AMHS address coordination through the AMC (see ICAO State Letter - Ref.:AN 7/49.1-09/34 from 14 April 2009).

Address Management is a key function used in support of address conversion, which is itself critical to AMHS operation during transition from CIDIN/AFTN to AMHS.

AMHS address is composed of two parts:

- A global domain identifier, which is globally unique within ICAO and AMHS
- Set of “low level” address attributes, which uniquely identify the user within the considered MD.

A modification in an AMHD Management domain creates a need for change in all other MDs worldwide. Three Sets of Information are managed by the Address Management function:

- 1) AMHS MD register
- 2) CAAS Table
- 3) User Address

The address Management function at the MIDAMC consists of two tabs; sub-functions, AMHS MD Register and Intra MD Address.

- ▶ Routing Directory
- ▶ Address Management
- ▶ User Capabilities Management
- ▶ Static Report
- ▶ COM Charts

View Pre-Operational Data

- ▶ Network Inventory
- ▶ Routing Directory and ACK
- ▶ Address Management
- ▶ User Capabilities Management
- ▶ Static Report (updated data)

Enter Background Data

- ▶ Network Inventory
- ▶ Address Management
- ▶ User Capabilities Management

Miscellaneous Functions

- ▶ Support Functions
- ▶ View Bulletin Board
- ▶ View AIRAC Cycle
- ▶ AMC Operator Details
- ▶ Path Function
- ▶ Convert AFTN Address
- ▶ Regions
- ▶ Send E-Mail to User Groups

Manage Background Data

AMHS MD Register
Operational Area [HELP]

AMHS MD Register **Intra MD Addressing**

Region: MID

Country-Name: XX

MD Common Name: SAUDI ARABIA

ADMD-Name: ICAO

HOME

PRMD-Name: SAUDI ARABIA

Addressing Scheme

CAAS

XF

SEARCH

MD Common Name: SAUDI ARABIA

PRMD-Name: SAUDI ARABIA

Country-Name: XX

ADMD-Name: ICAO

Addressing Scheme

CAAS

XF

ATN Directory Naming-Context: SAUDI ARABIA

Administrative Status: INTERNAL

Operational Status: OP

State(s)/ Organization(s)

State(s)/ Organization(s)	Nationality Letters or Designator
SAUDI ARABIA	OE

COM Centres

COM Centres	Location
OEJN	JEDDAH/KING ABDULAZIZ INTERNATIONAL

Created by: sara20061

Created on: 2014/03/04 12:36:51

Last Modified by: sara20061

Last Modified on: 2014/03/04 12:46:21

AMHS MD Register sub-function, which contains all MD information registered by ICAO Headquarters

AMHS MD Register consists of:

- *The name of the State or Organization*
- *The Nationality Letters (two letters), should be unique*
- *the global domain identifier of the Management Domain (GDI) , Made of three elements (High level Attribute)*
 - a) *Country-name attribute (C) = XX*
 - B) *Administrative Management Domain (A)= ICAO*
 - c) *Private Management Domain (P)*
- *The Addressing scheme (CAAS or XF)*
- *ATN directory naming-context*
- *COM Center*
- *CAAS table contains “O-OU1” relationship*



MIDAMC User Manual



One entry for each Location Indicator belonging to the AMHS MD, which in a CAAS address is borne by the *organisational-unit-names attribute (OU1)*. Each entry also includes the associated geographical unit identification, grouping several Location Indicators, which in a CAAS address is borne by the *organisation-name* attribute (O). Or Nationality Letters plus the wild card character(s) “*”

For MDs selected XF addressing scheme the table shall be empty

AMHS MD Register Intra MD Addressing

Region: MID MD Common Name: HE

Country-Name: XX ADMD-Name: ICAO PRMD-Name: SAUDI ARABIA

Addressing Scheme: CAAS XF

CAAS Table

Organization	Organizational Unit
HECA	HE**

User Address Table

AFTN Addr Indicator	O/R Address
---------------------	-------------

EXPORT CAAS TABLES REPORT

User addresses table contains full user O/R address and used to define any individual address in exceptional cases only.

www.midamc.jo/POPUPs/addUserAddress.aspx?MD=BRAZIL&ADMD=ICAO&COUNTRY=XX&PRMD=SB

Address Management [HELP]

Intra MD Addressing

Individual User O/R Address

Country-Name <input type="text" value="XX"/>	ADMD-Name <input type="text" value="ICAO"/>	PRMD-Name <input type="text" value="SB"/>	Organization <input type="text"/>		
Organizational Unit1 <input type="text"/>	Organizational Unit2 <input type="text"/>	Organizational Unit3 <input type="text"/>	Organizational Unit4 <input type="text"/>	Common Name <input type="text"/>	
Surname <input type="text"/>	Given Name <input type="text"/>	Initials <input type="text"/>	Gen.Qual. <input type="text"/>	DDA. Type <input type="text"/>	DDA. Value <input type="text"/>
<input type="text"/>	<input type="text"/>	<input type="text"/>	<input type="text"/>	<input type="text"/>	<input type="text"/>
<input type="text"/>	<input type="text"/>	<input type="text"/>	<input type="text"/>	<input type="text"/>	<input type="text"/>

User Identification

User Short Name <input type="text"/>	AFTN Address Indicator <input type="text"/>
---	--

3.3.1 Address Change:

Two categories of address changes

A) **Major changes** include:

- Addition or deletion of PRMDs
- Modification of PRMD-name
- Change of addressing scheme (from XF to CAAS or vice-versa)

Those changes have a major operational impact, They are expected to be infrequent, the MID CCC Operator should contact the MID AMC Operator or the CNS officer in ICAO MID Office to make a major Address change, cannot be entered into the MID AMC directly by the state user.

After Coordination with ICAO HQ, MID AMC enters the change into the MID AMC inform the EUR AMC Operator .



Procedure for Major change

- 1- An accredited person in the considered State declares the change to the MID Office for the ICAO Region or to the MID AMC Operator. the applicability date of the change (an AIRAC date); using a standard written pro-forma
2. The CNS Officer in the Regional Office, in coordination with ICAO Headquarters as appropriate, validates the acceptability of the declared change from an official and institutional viewpoint;
3. after validation, the CNS Officer forwards the declaration of change to the MID AMC Operator, **at the latest 21 days before the applicability date**
4. the MID AMC Operator enters data in the MID AMC (AMHS MD Register sub-function) based on the input received from the MID Office, at the appropriate time considering the applicability date of the change and using the AMC operational procedures; and inform the EUR AMC operator to take same action in the EUR AMC
5. at the date of applicability, i.e. at each AIRAC cycle date, the MID AMC users should retrieves an AMHS address management export file from the MID AMC and uploads it to AMHS system in place. MID AMC operator should notify MID users if there is a change.

B) Minor changes consist in modifications in a CAAS table, they have an operational impact which can be more limited and can be more frequent

Procedure for Minor change:

- 1- The CCC Operator in the considered State enters data corresponding to the intended change in the MID AMC during the Data entry Phase
- 2- The AMC operator performs the standard AMC operational procedures, such that the status of changed data is passed to “operational” at the applicability date;



MIDAMC User Manual



3. at the date of applicability, at each AIRAC cycle date, All MID AMC Users should export file from the MID AMC and uploads it to system in place.

3.4 Routing Management

Routing Management function deals with the creation and distribution of AMHS, CIDIN and AFTN routing tables for all COM Centers in the Middle East. Migration to AMHS requires integration of the AMHS routing table to the AFTN/CIDIN tables. And change in the AMHS Routing table impact the AFTN/CIDIN Routing tables.

This centralized function can look at the whole network in the MID and recommends optimal consistent routes. The Routing Management function is composed of three sub-functions, "AFTN Routing Table", "CIDIN Routing Table" and "AMHS Routing Table". Optimal Route means to create route with minimum number of hops, robust in the case of failures / overload, symmetry of routes, good distribution of traffic, and simple relationships with other Regions.

MID AMC has an automated tool which can detects:

- 1) Asymmetric Routes
- 2) Potential Loop
- 3) Incomplete path

The MID AMC Operator should recommend action to the CCC operator to rectify these inconsistencies hop .

The routing function includes three sub-function at the MIDAMC, AFTN Routing table, CIDIN Routing Table and AMHS Routing Table. As shown in the figure below:

- ▶ Routing Directory
- ▶ Address Management
- ▶ User Capabilities Management
- ▶ Static Report
- ▶ COM Charts

View Pre-Operational Data

- ▶ Network Inventory
- ▶ Routing Directory and ACK
- ▶ Address Management
- ▶ User Capabilities Management
- ▶ Static Report (updated data)

Enter Background Data

- ▶ Network Inventory
- ▶ Address Management
- ▶ User Capabilities Management

Miscellaneous Functions

- ▶ Support Functions
- ▶ View Bulletin Board
- ▶ View AIRAC Cycle
- ▶ AMC Operator Details
- ▶ Path Function
- ▶ Convert AFTN Address
- ▶ Regions
- ▶ Send E-Mail to User Groups

Manage Background Data

Routing Directory

AFTN Routing Table
CIDIN Routing Table
AMHS Routing Table

Region: COM-Centre: Location: Country:

MD Common Name: Country-Name: ADMD-Name:

Destination	Existing Main	MTCU	Existing Altn	MTCU	Planned
A	WSSS	<input type="checkbox"/>	OOMS	<input type="checkbox"/>	
B	LCNCA	<input type="checkbox"/>	OEJN	<input type="checkbox"/>	
C	LCNCA	<input type="checkbox"/>	OEJN	<input type="checkbox"/>	
D	OEJN	<input type="checkbox"/>	OOMS	<input type="checkbox"/>	
E	LCNCA	<input type="checkbox"/>	OEJN	<input type="checkbox"/>	
F	OEJN	<input type="checkbox"/>	OOMS	<input type="checkbox"/>	OEJN
G	OEJN	<input type="checkbox"/>	OOMS	<input type="checkbox"/>	OEJN
H*	OEJN	<input type="checkbox"/>	OOMS	<input type="checkbox"/>	OEJN

MTCU Mean...

3.4.1 AFTN Routing

Message routing is performed using character sequences extracted from the message addressee indicator; the destination composed from 1 to 8 characters

Destination	Main	Alternative
A	OSDI	HECA
OE	OEJN	HECA



MIDAMC User Manual



HE	HECA	OEJN
OJAQZPX	OJAQZPX	-

3.4.2 AMHS Routing

Message routing is performed using high level attributes (C,A,P) and O in some cases the AMHS Routing table should includes route to all AMHS MD worldwide.

The Destination expressed using the Global Domain Identifier of each AMHS Management domain. If an AMHS MD selected CAAS addressing scheme and has multiples International COM centers, "O" Value should be used in combination with the GDI as destination in AMHS Routing table

The screenshot shows the 'Routing Directory' interface with the 'AMHS Routing Table' selected. The configuration fields are as follows:

- Region: MID
- COM Centre: OJAM
- Location: AMMAN/MARKA
- Country: Jordan
- AMHS Matrix: V101
- MD Common Name: OJ
- Country-Name: XX
- ADMD-Name: ICAO
- PRMD-Name: OJ

The routing table data is shown in the following table:

Destination	Existing Main	Existing Alternate	Planned Main	Planned Alternate	Comments							
C	ADMD	PRMD	O	COM	M	COM	M	COM	M	COM	M	Comments
XX	ICAO	AG		OEJN	<input type="checkbox"/>	HECA	<input type="checkbox"/>		<input type="checkbox"/>		<input type="checkbox"/>	
XX	ICAO	AN		OEJN	<input type="checkbox"/>	HECA	<input type="checkbox"/>		<input type="checkbox"/>		<input type="checkbox"/>	
XX	ICAO	AY		OEJN	<input type="checkbox"/>	HECA	<input type="checkbox"/>		<input type="checkbox"/>		<input type="checkbox"/>	
XX	ICAO	DA		HECA	<input type="checkbox"/>	OEJN	<input type="checkbox"/>		<input type="checkbox"/>		<input type="checkbox"/>	
XX	ICAO	DB		HECA	<input type="checkbox"/>	OEJN	<input type="checkbox"/>		<input type="checkbox"/>		<input type="checkbox"/>	
XX	ICAO	DF		HECA	<input type="checkbox"/>	OEJN	<input type="checkbox"/>		<input type="checkbox"/>		<input type="checkbox"/>	
XX	ICAO	DG		HECA	<input type="checkbox"/>	OEJN	<input type="checkbox"/>		<input type="checkbox"/>		<input type="checkbox"/>	
XX	ICAO	DI		HECA	<input type="checkbox"/>	OEJN	<input type="checkbox"/>		<input type="checkbox"/>		<input type="checkbox"/>	

3.4.3 CIDIN Routing

CIDIN Routing table contains all CIDIN routes from each COM Centre supporting CIDIN operationally



MIDAMC User Manual



AFTN Routing Table | **CIDIN Routing Table** | **AMHS Routing Table**

Region: MID | COM Centre: OLBA | Location: BEIRUT/BEIRUT INTL | Country: Lebanon | HOME | AFTN Matrix: V101 | SEARCH

MD Common Name: OL | Country-Name: XX | ADMD-Name: ICAO | PRMD-Name: OL | Extended

Destination	Existing Main	MTCU	Existing Altn	MTCU	Planned Main	MTCU	Planned Altn	MTCU
A	OBBIA	<input type="checkbox"/>	OEJN	<input type="checkbox"/>		<input type="checkbox"/>		<input type="checkbox"/>
B	LCNCA	<input type="checkbox"/>	HECAA	<input type="checkbox"/>		<input type="checkbox"/>		<input type="checkbox"/>
C	LCNCA	<input type="checkbox"/>	HECAA	<input type="checkbox"/>		<input type="checkbox"/>		<input type="checkbox"/>
D	HECAA	<input type="checkbox"/>	OEJN	<input type="checkbox"/>		<input type="checkbox"/>		<input type="checkbox"/>
E	LCNCA	<input type="checkbox"/>	HECAA	<input type="checkbox"/>		<input type="checkbox"/>		<input type="checkbox"/>
F	OEJN	<input type="checkbox"/>	OBBIA	<input type="checkbox"/>		<input type="checkbox"/>		<input type="checkbox"/>
G	HECAA	<input type="checkbox"/>	OEJN	<input type="checkbox"/>		<input type="checkbox"/>		<input type="checkbox"/>
H	HECAA	<input type="checkbox"/>	OEJN	<input type="checkbox"/>		<input type="checkbox"/>		<input type="checkbox"/>

The CCC operator should “ACK” or “NACK” the proposed routing tables set by the MID AMC operator in the pre-operational Area with status “Proposed”. Routing tables can be exported as CSV file (Comma separated values) from the operational Area and loaded into AMHS system.

3.5 User Capabilities Management

User Capabilities Management function allows to manage and distribute information about the functional capabilities of an AMHS user. And will be particularly useful when the AMHS expands to new functions and/or new message types (e.g. BUFR, security, extended service, etc.), to determine the capabilities of a message recipient before sending the message.

The publication of this information, for retrieval by CCC Operators as an input to the configuration of the AMHS systems in their respective AMHS MDs .User Capabilities management Function enables the publication of this information for direct retrieval by AMHS message originators when generating a message to its possible recipients, potentially at each ATS Message User Agent.



MIDAMC User Manual



This aspect of the function is more related to directory functionality, and the provision of this service is not a priority of the ATS Messaging Management. The considered AMHS User Capabilities information comprises the direct as well as the indirect AMHS users and includes:

-The AMHS user OR-address and AF-address, as a reference and the following Capability Classes:

- Body-parts (which includes the former capability elements as defined in ICAO Document 9880 like 'maximum deliverable content length' and 'encoded information types – EITS'),
- Address type,
- IPM heading extensions,
- Directory,
- AMHS Security

The considered AMHS User Capabilities information comprises the direct as well as the indirect AMHS users and includes:

1) The AMHS user OR-address and AF-address, as a reference

2) The following Capability Classes:

- Body-parts (which includes the former capability elements as defined in ICAO Document 9880 like 'maximum deliverable content length' and 'encoded information types – EITS'),
- Address type,
- IPM heading extensions,
- Directory,
- AMHS Security

3.6 MIDAMC Miscellaneous Functions

These functions provide a description of set of miscellaneous functions related to support, reference information and data presentation under specific or transverse formats.

3.6.1 Support Function:

The Support (helpdesk) functions are a set of functions in which informal questions can be asked, and non-formal support obtained.

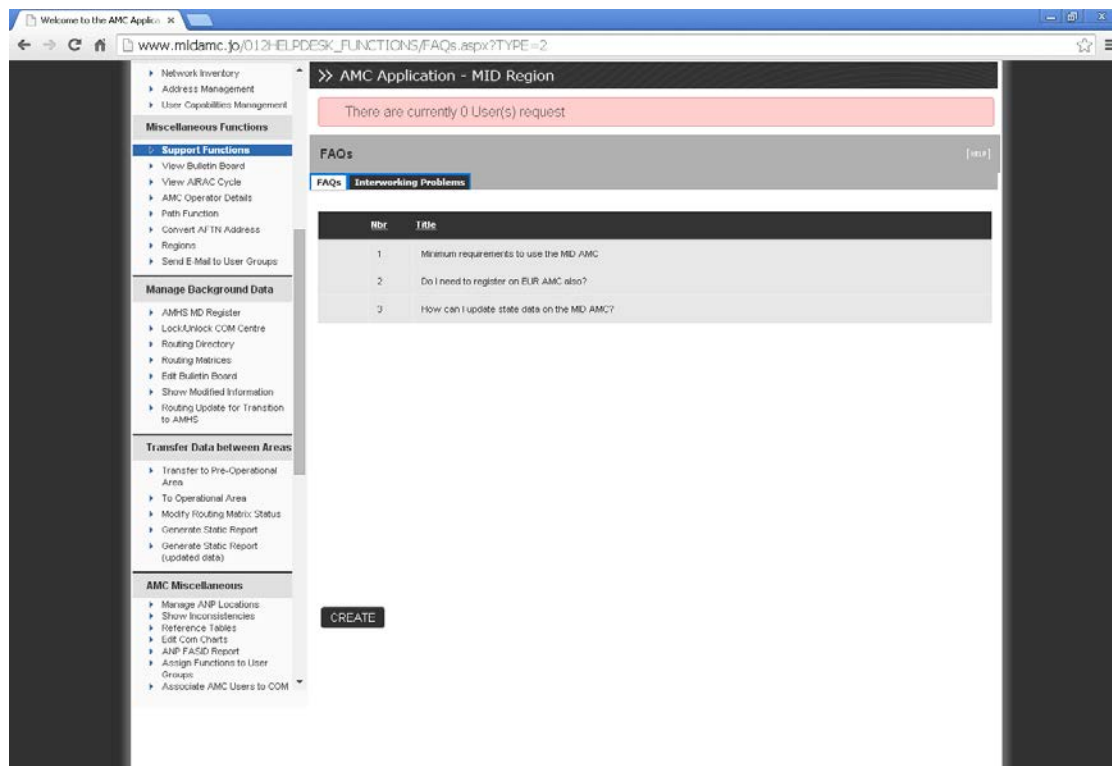

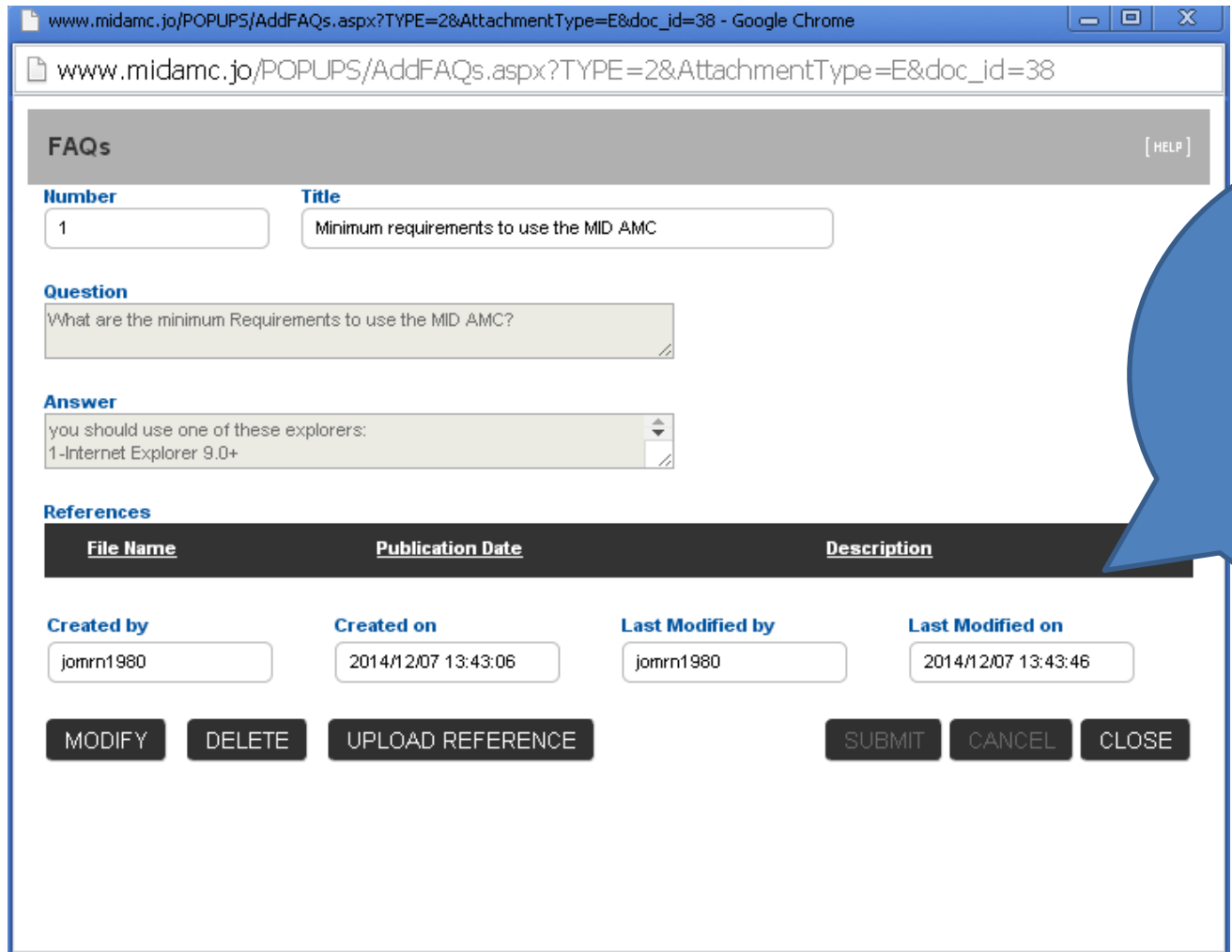

www.midamc.jo/POPUPS/AddFAQs.aspx?TYPE=2&AttachmentType=E&doc_id=38 - Google Chrome

www.midamc.jo/POPUPS/AddFAQs.aspx?TYPE=2&AttachmentType=E&doc_id=38

FAQs [HELP]

Number **Title**

Question

Answer

References

File Name	Publication Date	Description

Created by **Created on** **Last Modified by** **Last Modified on**

3.6.2 View Bulletin Board

The goal of the “View Bulletin Board” function is to facilitate communication between the MID AMC Operator and other MID AMC users. It enables users to see the bulletin board posted by the MID AMC Operator, to retrieve the e-mail address of the AMC Operator and to automatically create a blank e-mail to that address.

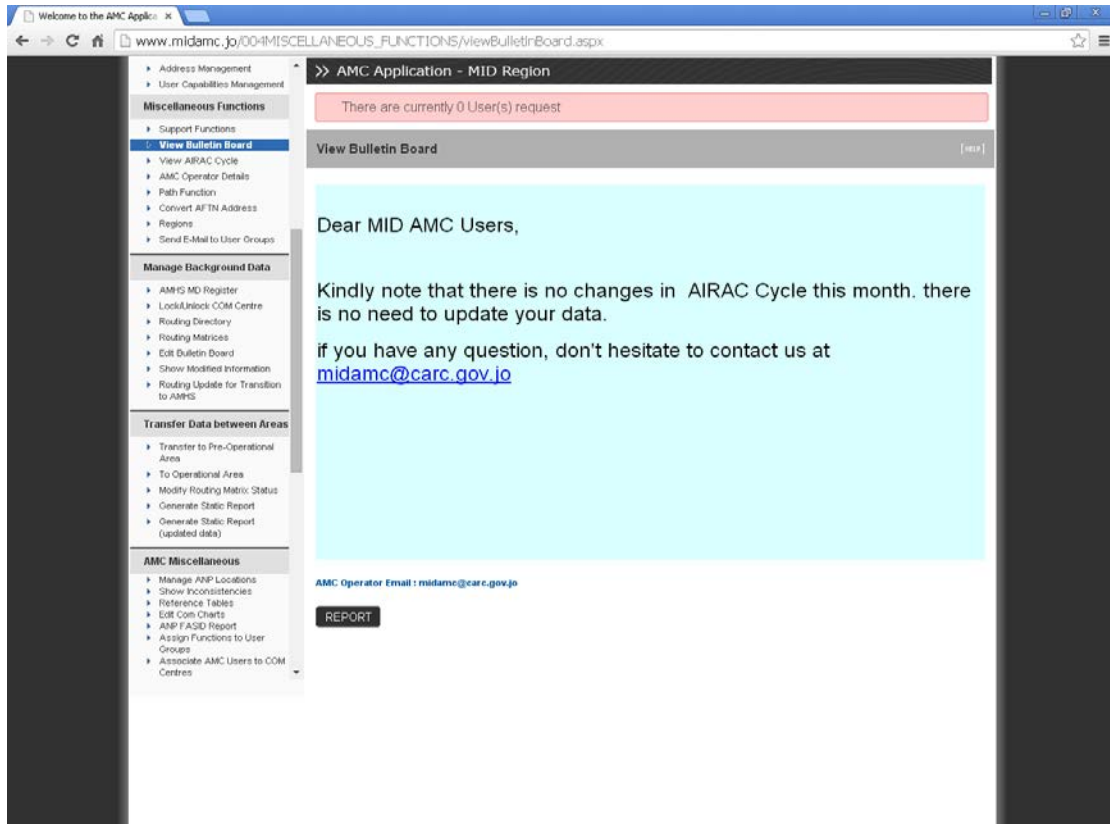

3.6.3 View AIRAC Cycle

This function gives a generic view of the seven phases of the AIRAC cycle with the milestones related to the procedures.



MIDAMC User Manual



3.6.4 AMC Operator Details

Firstname	Surname	Phone	Fax	Remark
MaisOON	Owneh	0799838980		
Majdolin	AL_Trad	0796714942		
Yaser	Ziad	0799876710		

3.6.5 Path Function

The “Path Function” calculates end-to-end paths in the integrated network, taking into account the routing in each network technology and the specified routes via gateways (AFTN to AMHS and vice-versa). It is closely related to the Routing management function, as it directly exploits the contents of a given set of routing tables.

This function enables to see the path between two COM Centres in the network, determined by the combination of the routing tables comprised in the matrix selected in the search area.

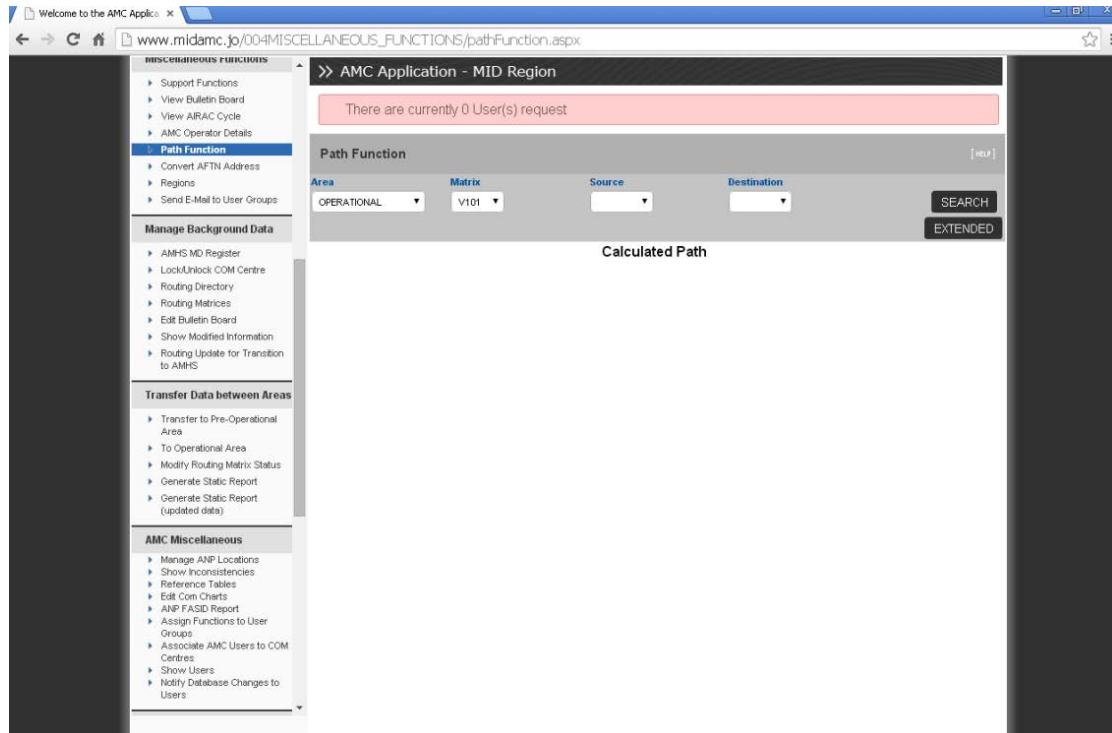

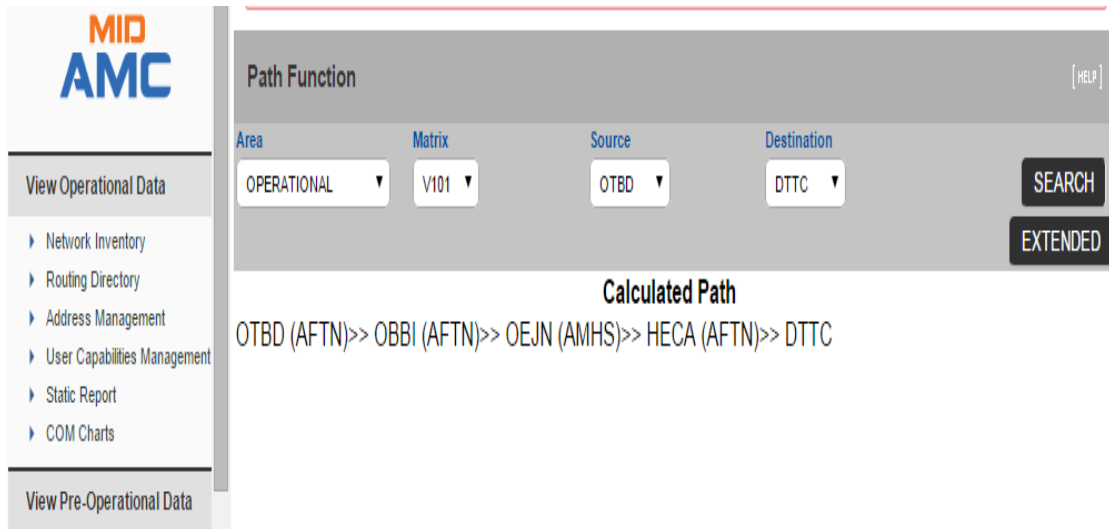

3.6.6 Convert AFTN Address

This function convert AFTN address into AMHS address according to the Addresses tables included at the MIDAMC

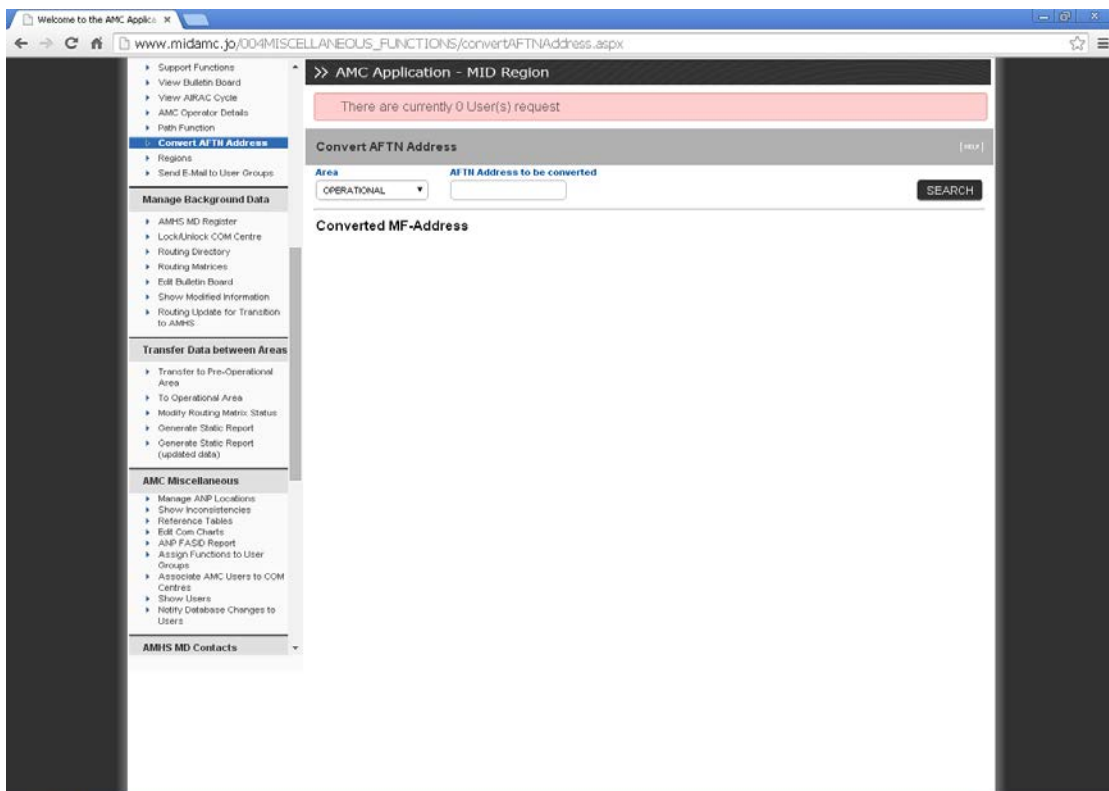

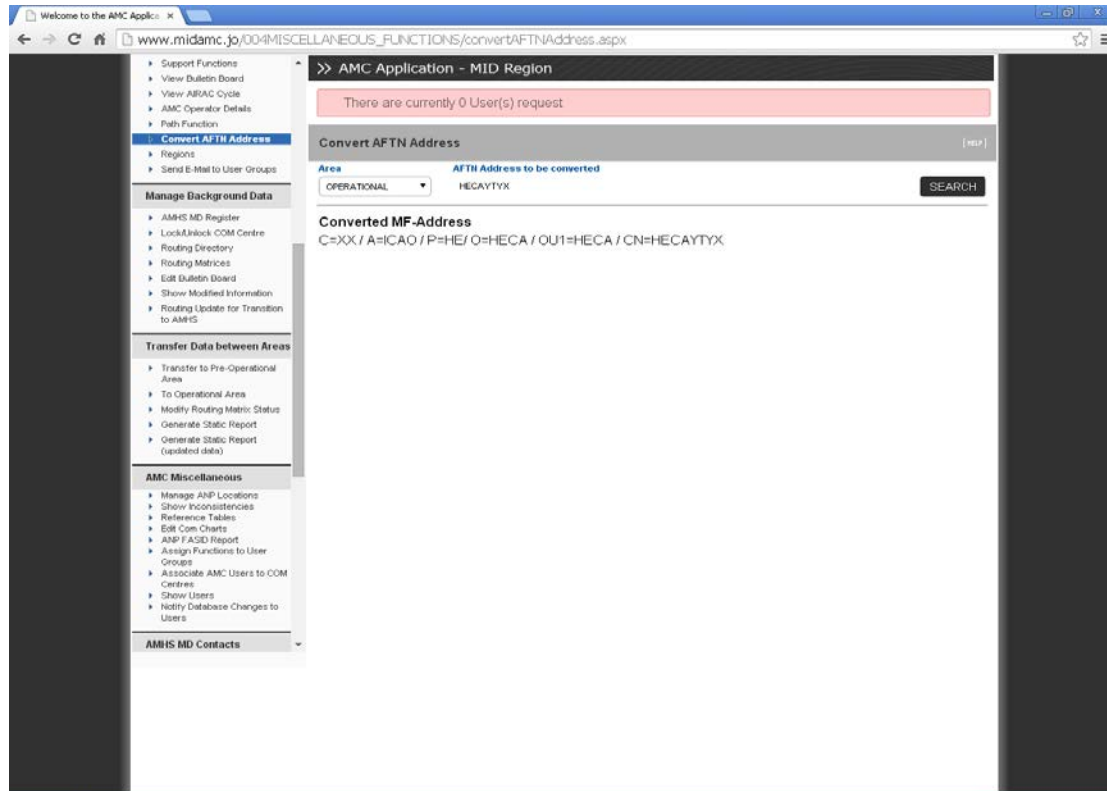

3.6.7 Region

The goal of the “Regions” function is to provide general information about each ICAO Region, including postal address of the Regional Office, ICAO persons and contacts and COM Centers associated with each Region.

ICAO Six regions :

- AFI (Africa)
- ASIA/PAC (Asia Pacific)
- EUR/NAT (Europe North Atlantic)
- MID (Middle East)
- NAM/CAR (North Atlantic Caribbean)
- SAM (South America)

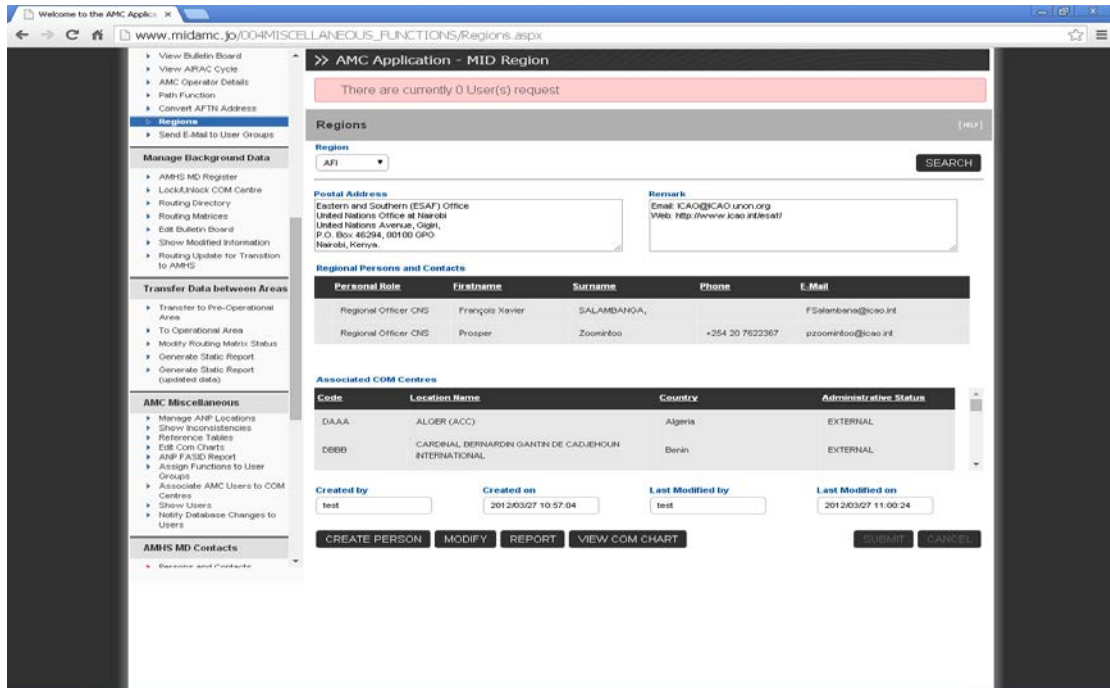

3.6.8 Send email to User Group

This function enables the CCC Operator to create and send an E-Mail to a group of users listed in the table managed by the Persons and Contacts function.

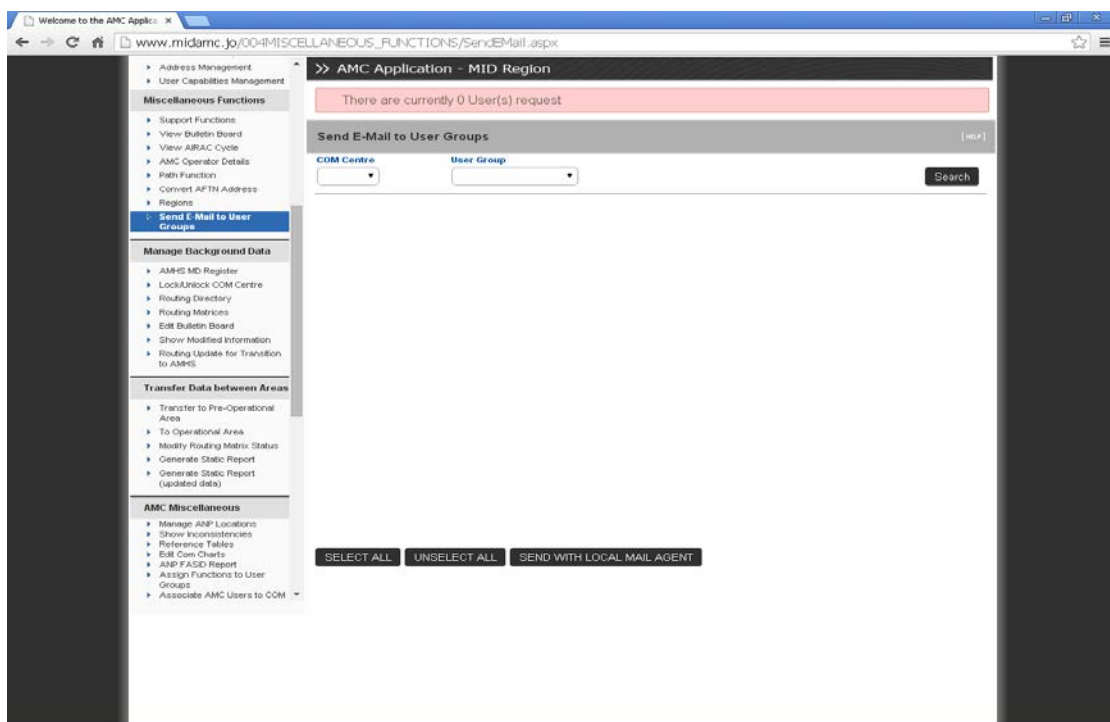

4. AMF-I Functions

AMF-I stands for **AMHS** offline **Management Functions - Implementation Support**, the Purpose of these functions are to:

- 1- To provide support to States that are in the process of implementing AMHS, and do not yet have AMHS in operational use.
- 2- To be used by States that have already started operational use of AMHS and plan future evolution of their AMHS systems.

4.1 AMHS MD Contact

This function enables to identify Users and contacts involved in AMHS Implementation process in AMHS MD

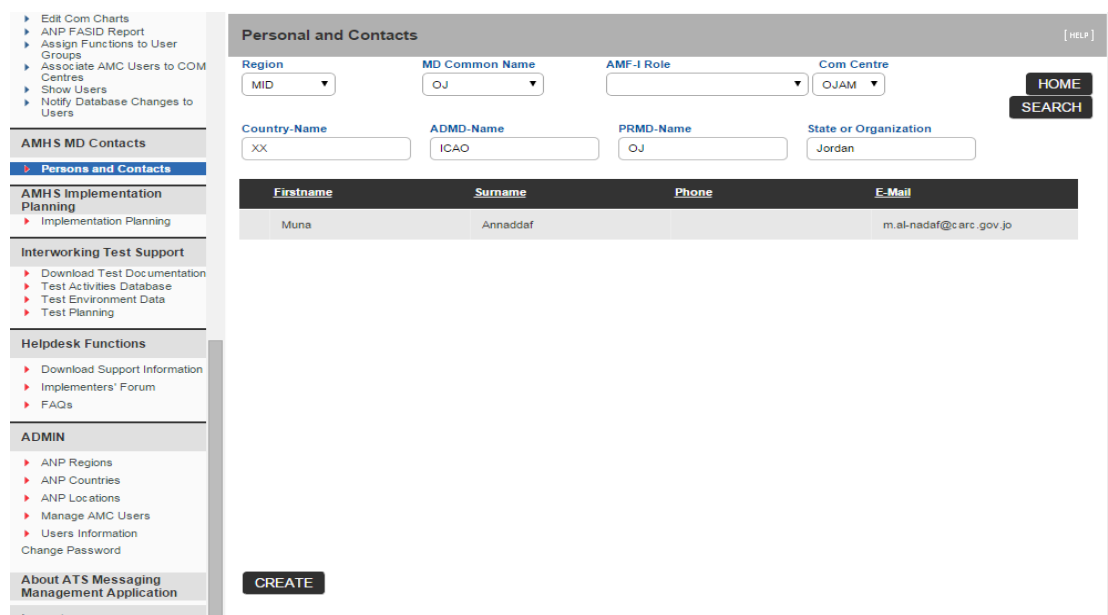

Region	MD Common Name	AMF-I Role	Com Centre
MID	OJ		OJAM

Country-Name	ADMD-Name	PRMD-Name	State or Organization
XX	ICAO	OJ	Jordan

Firstname	Surname	Phone	E-Mail
Muna	Annadaf		m.al-nadaf@carc.gov.jo

4.2 AMHS Implementation Plan

This function enables to exchange information about implementation plans of ANSPs

- ▶ Edit COM Charts
- ▶ ANP FASID Report
- ▶ Assign Functions to User Groups
- ▶ Associate AMC Users to COM Centres
- ▶ Show Users
- ▶ Notify Database Changes to Users

AMHS MD Contacts

- ▶ Persons and Contacts

AMHS Implementation Planning

- ▶ Implementation Planning

Interworking Test Support

- ▶ Download Test Documentation
- ▶ Test Activities Database
- ▶ Test Environment Data
- ▶ Test Planning

Helpdesk

- ▶
- ▶

AD

- ▶ ANP Reg
- ▶ ANP Countries
- ▶ ANP Locations
- ▶ Manage AMC Users

Implementation Planning

Region

MD Common Name

HOME

Country-Name

ADMD-Name

PRMD-Name

	AFTN/AMHS Gateway (MTCU)	ATS Message Server (switch)
System Available in State	2008	2008
Start of Pre-Operational International Testing	2010	2010
Beginning of Operational Service	2010	2010

Plans from inter-Regional gateway Capability Comments and Remarks

Created by

Created on

Last Modified by

MODIFY/CREATE

REPORT

CONSOLIDATED REPORT

All Region ▼



4.3 Helpdesk Function

Helpdesk Function is an interactive community website includes:

- Support Information to be downloaded
- Implementers' forum
- Frequently Asked Questions (FAQs) related to AMHS Implementation, AMHS Operation FAQs under Miscellaneous



References List

R1	ICAO Annex 10 – Aeronautical Telecommunication; Vol.II, Communication Procedure
R2	ICAO doc 9880- Manual on Detailed Technical Specifications for the Aeronautical Telecommunication Network (ATN) using ISO/OSI Standards and Protocols, Part II – Ground-Ground Applications - Air Traffic Services Message Handling Services (ATSMHS), First Edition – 2010
R3	EUR Doc 020 – AMHS Manual
R4	AMC Operator Manual, V1.01
R5	AMC User Manual, V 2.0

APPENDIX 6A

**MIDAMC Steering Group
(MIDAMC STG)**

1. TERMS OF REFERENCE (TOR)

1.1 The Terms of Reference of the MIDAMC Steering are:

- a) to promote the efficiency and safety of aeronautical fixed services in the MID Region through the operation and management, on a sound and efficient basis, of a permanent MID Regional ATS Messaging Management Center (MIDAMC);
- b) foster the implementation of the Air traffic service Message handling service in the MID Region through provision of the guidance materials and running facilitation tools, utilizing the MIDAMC;
- c) MIDAMC Steering Group will consist of a focal point from each Participating MID State who would represent the State and acts as the Steering Group Member;
- d) MIDAMC Steering Group will be responsible for overall supervision, direction, evaluation of the MIDAMC project and will review/update the MIDAMC work plan whenever required;
- e) The MID Region is considering the establishment of Regional IP Network; the MIDAMC STG will drive the project until the Operation Group is established; and
- f) provide regular progress reports to the CNS SG, ANSIG and MIDANPIRG concerning its work programme.

1.2 In order to meet the Terms of Reference, the MIDAMC Steering Group shall:

- a) Develop/update the accreditation procedure for all users on the MIDAMC;
- b) develop and maintain guidance materials for MIDAMC users;
- c) discuss and identify solution for operational problems may be arising;
- d) provide support/guidance to States for AMHS Implementation, and monitor the AMHS activities;
- e) assist and encourage States to conduct trial on Implementation of the ATS extended services, and identify operational requirements;
- f) identify the need for any enhancement for the MIDAMC and prepare functional and technical specifications, and define its financial implications;

- g) follow-up on ICAO standards and recommendations on the ATS messaging management;
- h) define future liabilities and new participating States and ANSPs;
- i) follow-up and review the work of similar groups in other ICAO Regions; and
- j) Follow of the Reginal IP Network project and proposes appropriate actions for the early implementation also support the IP Network until the Operational Group is establish

2. COMPOSITION

- a) ICAO MID Regional Office;
- b) Members appointed by the MIDANPIRG member States; and
- c) other representatives, who could contribute to the activity of the Steering Group , could be invited to participate as observers, when required .

ATTACHMENT

MIDAMC STG/3
Attachment A to the Report

LIST OF PARTICIPANTS

NAME	TITLE
<u>STATES</u>	
BAHRAIN	
Mr. Mohamed Ali Saleh	Chief, Aeronautical Telecommunication Civil Aviation Affairs KINGDOM OF BAHRAIN
Mr. Yaseen Hassan Al Sayed	Head Aeronautical Telecommunication Network Senior Computer Network Administrator Civil Aviation Affairs KINGDOM OF BAHRAIN
EGYPT	
Mr. Ahmed Saied Abdel Monsef	CNS/ATM Inspector at ECAA Egyptian Civil Aviation Authority Cairo - EGYPT
Mr. Islam Awad Zaki Awad	Air Navigation Inspector Ministry of Civil Aviation Cairo - EGYPT
Mr. Mohamed Ramzy M. Abdallah	Director of AFTN/AMHS Aeronautical Information Engineer National Air Navigation Services Company Egyptian Civil Aviation Authority Cairo – Egypt
Mr. Mohamed Ahmed Mohamed Hamed	Head Engineer of Meteo Computer Systems National Air Navigation Services Company Egyptian Civil Aviation Authority Cairo - Egypt
Mr. Ashraf Mostafa Mohamed Qurany	General Manager of Flight Plan & Follow-up Operation National Air Navigation Services Company Egyptian Civil Aviation Authority Cairo – Egypt

NAME	TITLE
Mr. Essam Helmy Mohamed	Operations Manager for AMSC Cairo Airport - CANC National Air Navigation Services Company Egyptian Civil Aviation Authority Cairo - Egypt
Mr. Ahmed Mohamed Ahmed Farghaly	Safety & Competency Observer National Air Navigation Services Company Egyptian Civil Aviation Authority Cairo - Egypt
Mr. Mohamed Khattab El Sayed El Shafei	System Engineer National Air Navigation Services Company Egyptian Civil Aviation Authority Cairo - Egypt
ISLAMIC REPUBLIC OF IRAN Mr. AliAkbar SalehiValojerdi	Senior Expert of IRANAFTN/AMHS Training Department IRAN Airports Company, Central Building Tehran - Islamic Republic of IRAN
Mr. Alireza Mahdavisefat	Senior Expert of IRANAFTN/AMHS COM Centre IRAN Airports Company, Central Building Tehran - Islamic Republic of IRAN
JORDAN Mrs. Majdalin M. Al-trad	AFTN/AMHS Supervisor/MID AMC Operator Civil Aviation Regulatory Commission Amman - JORDAN
Mrs. Muna Ribhi Alnadaf	Chief of AFS Engineering/MID AMC Project Manager Civil Aviation Regulatory Commission Amman - JORDAN
KUWAIT Mr. Meshal Abdulh Alkhalidi	Head of the Communications Kuwait Airport – Air Navigation Communications and Operations KUWAIT

NAME	TITLE
<p>LEBANON</p> <p>Mr. Elias El-Khoury</p>	<p>Director of Technical Exploitation Lebanese Directorate General of Civil Aviation Beirut – LEBANON</p>
<p>Mr. Joseph Al Soueidy</p>	<p>Chief of Telecom. Monitoring Directorate General of Civil Aviation Beirut - LEBANON</p>
<p>Mr. Mohamad Abdallah Saad</p>	<p>Head of Telecommunication Equipment Lebanese Directorate General of Civil Aviation Beirut – LEBANON</p>
<p>Mr. Rabih El Harake</p>	<p>Telecommunications Supervisor Lebanese Directorate General of Civil Aviation Beirut – LEBANON</p>
<p>SAUDI ARABIA</p> <p>Mr. Ali Awad Al-Dahri</p>	<p>Manager of Aeronautical Telecommunication Air Traffic Management General Authority of Civil Aviation KINGDOM OF SAUDI ARABIA</p>
<p>Mr. Ehab H. Saleem</p>	<p>Senior Software Engineer Automation Engineering Branch General Authority of Civil Aviation KINGDOM OF SAUDI ARABIA</p>
<p>Mr. Ibraheem M. Basheikh</p>	<p>Senior Systems Engineer Automation Engineering Branch General Authority of Civil Aviation KINGDOM OF SAUDI ARABIA</p>
<p>UNITED ARAB EMIRATES</p> <p>Mr. Yousif Al Awadi</p>	<p>Senior Research and Dataset Officer General Civil Aviation Authority Abu Dhabi- UNITED ARAB EMIRATES</p>

NAME	TITLE
<u>ORGANIZATIONS/INDUSTRIES</u>	
SITA Mr. Adel Hamed	Senior Product Specialist USA

-END-