



*International Civil Aviation Organization*

**AIR NAVIGATION SYSTEMS IMPLEMENTATION GROUP**

**First Meeting (ANSIG/1)**  
*(Cairo, Egypt, 10 – 12 February 2015)*

---

**Agenda Item 4: Performance Framework for Regional Air Navigation Implementation**

MID SSR CODE MANAGEMENT PLAN

*(Presented by the Secretariat)*

**SUMMARY**

This paper presents a revised version of MID Secondary Surveillance Radar (SSR) Code Management Plan (CMP), for the meeting review and update as deemed necessary.

Action by the meeting is at paragraph 3.

**REFERENCES**

- ANP WG/2 Report
- MIDNPIRG/13 Report

**1. INTRODUCTION**

1.1 The Middle East Secondary Surveillance Radar (SSR) Code Management Plan (CMP) was endorsed by MIDANPIRG/13 through Conclusion 13/7, based on the outcome of the SSR Code Allocation Study Group (SSRCA SG).

**2. DISCUSSION**

4.2.1 The meeting may wish to note that MIDANPIRG/13 meeting agreed that data related to the MID Region traffic patterns and volume, Flight Data Processing Systems' (FDPS) capabilities and requirements in adjacent ICAO Regions, was necessary in order to reach a decision on the number of the participating Areas (Pas) and codes allocated to each PA.

4.2.2 The MIDANPIRG/13 meeting noted that MIDANPIRG/12 urged MID States to identify and address inefficiencies in the current Originating Region Code Assignment Method (ORCAM) structure before adopting an alternate structure in order to overcome the SSR code shortage.

4.2.3 The MIDANPIRG/13 meeting noted that the SSRCA SG/4 meeting reviewed the study carried out by EUROCONTROL on the MID Regional traffic patterns for the month of June 2009. The results of the study indicated that for the short and medium term; there is no need to split the MID PA into multiple areas.

4.2.4 The MIDANPIRG/13 meeting noted that the following SSR Codes in the transit series were conflicting between the EUR and MID Regions: 06, 11, 21, 23, 25, 27, 30, 35, 37, 41, 60, 61, 66, 71. It was noted with appreciation that this issue had been resolved through the development of the MID SSR Code Allocation list for the MID Region.

4.2.5 Based on the above, the MIDANPIRG/13 meeting endorsed the SSR Code Management Plan (CMP) which includes the revised SSR Code allocation List.

4.2.6 The MIDANPIRG/13 meeting was of the view that the SSRCA Study Group has completed its work programme and agreed to its dissolution, providing that the remaining SSRCA issues be addressed by the ATM SG.

2.1 The meeting may wish to note that the SSR CMP has been revised by the Secretariat in order to reflect the SSR codes allocated to Libya and Sudan, as at **Appendix A**.

2.2 In connection with the above, the meeting may wish to recall that the SSR codes allocated to the MID States should be included in the MID eANP, Volume II, Table ATM II-MID-2 – *MID SSR Code Allocation List*, as at **Appendix B**.

2.3 Taking into consideration that Libya and Sudan became part of the MID Region Participating Area, potential conflict were identified as follows:

- 0100-0177: allocated for Transit use to Sudan and for Domestic use to Saudi Arabia;
- 4000-4077: allocated for Transit use to Libya and Oman;
- 5200-5277: allocated for Transit use to Saudi Arabia and for Domestic use to Sudan; and
- 5300-5377: should be reserved for temporary Transit use, it was allocated to Sudan for Domestic use.

2.4 The meeting may wish to note that the Request Form for temporary assignment of SSR codes required for seasonal high traffic activities and intensive military exercise requirements, at **Appendix C**, was endorsed by MIDANPIRG/13.

### **3. ACTION BY THE MEETING**

3.1 The meeting is invited to:

- a) review and update, as deemed necessary, the MID SSR CMP and the MID eANP, Volume II, Table ATM II-MID-2 – *MID SSR Code Allocation List* at **Appendices A and B**, respectively;
- b) agree on the necessary actions to mitigate the potential conflicts highlighted at para 2.3; and
- c) urge States to:
  - i. strictly use the SSR codes assigned to them in accordance with the MID SSR CMP; and
  - ii. report interference/conflict cases, if any, to the ICAO MID Regional Office related to the misuse of SSR codes.

-----

# INTERNATIONAL CIVIL AVIATION ORGANIZATION



## MIDDLE EAST SECONDARY SURVEILLANCE RADAR CODE MANAGEMENT PLAN (SSR CMP)

Second Edition  
NOVEMBER, 2014

THE DESIGNATIONS AND THE PRESENTATION OF MATERIAL IN THIS PUBLICATION DO NOT IMPLY THE EXPRESSION OF ANY OPINION WHATSOEVER ON THE PART OF ICAO CONCERNING THE LEGAL STATUS OF ANY COUNTRY, TERRITORY, CITY OR AREA OF ITS AUTHORITIES, OR CONCERNING THE DELIMITATION OF ITS FRONTIERS OR BOUNDARIES.

**TABLE OF CONTENTS**

1 SCOPE ..... 1  
    1.1 Relationship to MID Air Navigation Plan (Doc 9708) ..... 1  
2 DEFINITIONS AND ABBREVIATIONS ..... 2  
    2.1 Definitions..... 2  
    2.2 Abbreviations ..... 3  
3 INTRODUCTION..... 4  
    3.1 Objectives of the Middle East SSR Code Management Plan ..... 4  
    3.2 General Principles To Meet The Objectives ..... 4  
    3.3 Monitoring of the Plan ..... 5  
4 PERMANENT CODE DISTRIBUTION AND CATEGORIES ..... 5  
    4.1 Distribution of codes ..... 5  
    4.2 Special purpose codes ..... 6  
    4.3 Transit codes ..... 7  
    4.4 Domestic codes ..... 7  
5 ORCAM ..... 8  
    5.1 OUTLINE OF ORCAM OBJECTIVES ..... 8  
6 ORCAM SYSTEM REQUIREMENTS..... 9  
    6.1 Introduction..... 9  
    6.2 General System Considerations ..... 9  
    6.3 Essential Capabilities for Automated ATC Ground Systems ..... 10  
APPENDIX A - PARTICIPATING AREAS ..... i  
APPENDIX B - GENERAL PROCEDURES FOR SSR CODE ASSIGNMENT ..... iii  
APPENDIX C - IMPLICATIONS FOR AUTOMATION ..... vii  
APPENDIX D - DEVELOPMENT OF AUTOMATED SSR CODE ASSGNEMENT SYSTEMS... xi



## 1 SCOPE

### 1.1 RELATIONSHIP TO MID AIR NAVIGATION PLAN (DOC 9708)

- 1.1.1 The *Middle East Secondary Surveillance Radar Code Management Plan* has been produced on behalf of the Middle East Air Navigation Planning and Implementation Regional Group (MIDANPIRG).
- 1.1.2 The purpose of MID CMP is to detail the requirements to be met by the States of the ICAO Middle East (MID) Region in order to comply with the provisions of the *Middle East Basic Air Navigation Plan* (MID ANP) (Doc 9708, Volume I) and the *Middle East Facilities and Services Implementation Document* (MID FASID) (Doc 9708, Volume II) as they pertain the management of Secondary Surveillance Radar (SSR) codes in the ICAO MID Region. This document incorporates text that currently comprises **Attachment B** to the MID FASID along with new material to document the management of the regional SSR Code pool.
- 1.1.3 The technical requirements and associated procedures may also be adopted by States in adjoining ICAO Regions which elect to participate in the Originating Region Code Assignment Methodology (ORCAM) for the management of SSR codes.
- 1.1.4 All references to SSR Codes are confined to Mode 3/A. The use and allocation of Mode S Interrogator Codes is covered by **Appendix 4A** to Table **CNS 4** to the MID FASID.

## 2 DEFINITIONS AND ABBREVIATIONS

### 2.1 DEFINITIONS

Assigned Secondary Surveillance Radar code (ASSR)	The SSR code assigned by an ATS Unit (ATSU) to a departing aircraft or to an aircraft entering the airspace of the ATSU. <i>Note: In cases where the Previous Secondary Surveillance Radar code (PSSR) can be retained, PSSR and ASSR can be the same code</i>
(SSR) Code	The number assigned to a particular multiple pulse reply signal transmitted by a transponder in Mode A or Mode C.
Code allocation	The distribution of SSR Codes to a State, unit or service.
Code assignment	The distribution of SSR codes to aircraft.
Code block	A continuous series of four-digit codes from the same code series.
Code series	A group of 64 four-digit codes having the same first two digits.
Direction of flight	The direction shall be defined as a combination of one or more: a) exit points or receiving Areas of Responsibility (AOR); and b) destinations (defined by the first, the first two, the first three or all four letters of an ICAO location indicator).
Directional assignment	Assignment of an SSR code based on the direction of the flight.
Discrete code	A four-digit code with the last two digits not being “00”.
Domestic code	A code allocated to a specific AOR for use by designated ATC unit(s) within that AOR or, subject to certain conditions, across AOR boundaries.
Expectation window	A window of variable size around a 4D position, defined by flight plan information, at which a flight is expected to enter the AOR.
Four-digit code	An SSR identity code containing combinations of A, B, C and D pulses (any reply generated by a 4096-code transponder where the digits fall in the range 0-7).
Geographical correlation	Correlation of a flight with its flight plan using the geographical position of the flight by means of “Expectation Windows” in cases where the SSR code is already in use by one or more other flights within the same AOR.
Mode S Conspicuity Code	In order to maximise SSR code savings through Mode S Elementary Surveillance (ELS), all aircraft identified via the down linked Aircraft Identification (ACID) use the same SSR code, the Mode S Conspicuity Code A1000.
Octal block	A block of 8 four-digit codes from the Same Series and having the first three digits common. They may be identified by indicating their third digit when referring to the Code Series e.g. Codes 0010-0017 may be referred to as Codes 00(1).
Participating area (PA)	An area of specified dimensions comprising the areas of ATS unit responsibility of one or more States.
Previous Secondary Surveillance Radar code (PSSR)	The SSR code transmitted by an aircraft when entering the airspace of an ATSU or when being transferred by the transferring unit. <i>Note: In cases where the PSSR can be retained, PSSR and ASSR can be the same code.</i>



Simultaneous code use	Assignment of an SSR code, which is already in use within the same AOR, to an aircraft in accordance with procedures which ensure that the two aircraft will be exiting the AOR in opposite or nearly opposite directions.
Retention of an SSR code	Accepting an aircraft from the transferring unit without changing the SSR code. A code can be retained if no other aircraft within the AOR uses the same code and if the retention of the code is in accordance with the Code Allocation List (CAL).
Transit code	A code allocated to a State for a specified ACC for assignment to an aircraft engaged in transit flights within the originating PA or, subject to certain conditions, to specified locations in succeeding PAs.

## 2.2 ABBREVIATIONS

ABI	Advance Boundary Information
ACID	Aircraft Identification
ADEP	Aerodrome of Departure
ADES	Aerodrome of Destination
AOR	Area of Responsibility
ASSR	Assigned Secondary Surveillance Radar code
ATC	Air Traffic Control
ATS	Air Traffic Services
ATSU	Air Traffic Services Unit
CAL	Code Allocation List for the Middle East Region
CMP	Code Management Plan
COD	SSR Code Assignment Message
MIDANPIRG	Middle East Air Navigation Planning and Implementation Regional Group
ELS	Elementary Surveillance
FDPS	Flight Data Processing System
FIR	Flight Information Region
NM	Nautical Mile
ORCAM	Originating Region Code Assignment Method
PA	Participating Area
PSSR	Previous Secondary Surveillance Radar code
RDPS	Radar Data Processing System
SSR	Secondary Surveillance Radar
VSP	Variable System Parameter

### 3 INTRODUCTION

#### 3.1 OBJECTIVES OF THE MIDDLE EAST SSR CODE MANAGEMENT PLAN

- 3.1.1 The Middle East SSR Code Management Plan (MID SSR CMP) has been established to provide States in the ICAO MID Region with means to coordinate the use of SSR codes based on the principles of the Originating Region Code Assignment Method (ORCAM), which provides for the most efficient and economical use of codes.
- 3.1.2 The MID SSR CMP will foster the implementation of ORCAM which will ultimately allow for an assigned discrete code which would, whenever possible, be retained throughout the flight.
- 3.1.3 For the development of automated SSR code assignment systems, reference should be made to Paragraph 6 below.
- 3.1.4 On the basis of the above, a detailed Code Allocation List (CAL) for the MID Region Participating Area (PA) and certain adjacent areas was developed. The CAL is maintained by the ICAO MID Regional Office as a Supplement to MID Doc 9708.
- 3.1.5 The agreed allocation of SSR codes to States and ATS units are documented in Part A of the CAL. The detailed listing of codes serving both transit and domestic purposes is shown in Part B of the CAL. The CAL is at **Attachment B** to the MID FASID, Part V.

#### 3.2 GENERAL PRINCIPLES TO MEET THE OBJECTIVES

- 3.2.1 The detailed principles governing the use of SSR codes in the MID Region are based on the following general principles which are provided by or are complementary to the worldwide provisions detailed in *Procedures for Air Navigation Services — Air Traffic Management* (PANS-ATM, Doc 4444), Chapter 8:
- a) codes shall be allocated to States in accordance with regional air navigation agreements, taking into account overlapping radar coverage over adjacent airspace;
  - b) codes are allocated to Air Traffic Services Units (ATSU) on the basis of duly justified operational requirements; their number is primarily established by taking into account the number of aircraft to be handled simultaneously and the system capabilities;
  - c) the appropriate ATS authority shall establish a plan and procedures for the allocation of codes to ATSUs;
  - d) the plan and procedures for the allocation of codes to ATSUs shall be compatible with those practised in adjacent States;
  - e) codes shall be assigned to aircraft in accordance with the plan and procedures laid down by the appropriate ATS authority;
  - f) whenever there is a need for individual aircraft identification, each aircraft shall be assigned a discrete code which should, whenever possible, be retained throughout the flight;
  - g) the assignment of a code should preclude the use of this code for any other function within the area of coverage of the same SSR for a prescribed time period; and
  - h) to reduce pilot/controller workload and the need for communications, the number of code changes required shall be kept to the minimum.
- 3.2.2 SSR codes should be used for ATS purposes only.

- 3.2.3 Code allocations are expressed in terms of complete code series or specified parts thereof. In special cases, such requirements may even cover designated discrete codes.
- 3.2.4 Codes intended to be used for transit purposes are allocated to States for use by specified ATSUs within the MID PA. Where provided for in the *Middle East SSR Code Management Plan* and under clearly defined circumstances, such codes may also be designated for use across PA boundaries.
- 3.2.5 Codes intended to be used for domestic purposes are allocated to States for use by specified ATSUs requiring limited geographical protection for such codes. Where provided for in the MID SSR CMP and under clearly defined circumstances, such codes may also be designated for use across national boundaries.

### **3.3 MONITORING OF THE PLAN**

- 3.3.1 Provisions regarding the progressive implementation and monitoring of the MID SSR CMP have been agreed by the MIDANPIRG. In this connection, the management of the MID SSR CMP is exercised by the ICAO MID Regional Office. States expecting to introduce or change SSR facilities are requested to advise the ICAO MID Regional Office at least six months in advance, in order to provide sufficient time to carry out any necessary coordination.
- 3.3.2 To be effective, the MID SSR CMP must be kept up to date. While its contents will be reviewed regularly, it is the responsibility of all States to inform the ICAO MID Regional Office promptly of any variations proposed or considered necessary with respect to their code allocations, relevant to ATS infrastructure developments and/or the guidance material provided in the MID SSR CMP.
- 3.3.3 In order to serve their purposes it is imperative that the MID SSR CMP and the CAL are kept up to date. States are therefore required to inform the MID Office of ICAO promptly of any requests for changes, additions or deletions in regard to the use of specific codes, as follows:

#### **ICAO MID Regional Office**

Subject: SSR Code Management  
E-mail:  
icaomid@cairo.icao.int  
Fax: +2 (02) 22674843

## **4 PERMANENT CODE DISTRIBUTION AND CATEGORIES**

### **4.1 DISTRIBUTION OF CODES**

- 4.1.1 Certain codes are reserved for special purposes on a worldwide scale or have been put in a common pool for use in the MID Region. The remaining code series for use in the ICAO MID Region are divided into two distinct types: transit codes and domestic codes. Both domestic and transit codes may be used as directionally assigned codes beyond their normal application under clearly defined and published circumstances, and appropriately coordinated through ORCAM.
- 4.1.2 The number of codes used for transit purposes has to take account of the extended geographical protection required, in order to reduce to a minimum the chances of confusion between the identities of two different aircraft assigned with the same discrete code. The MIDANPIRG has agreed that the retention time should normally be two hours.

4.1.3 The number of codes used for domestic purposes can be kept relatively small as they may be repeated within the same State or they can be used by other States provided a buffer is established. In some cases, by agreement, they can be used across national boundaries.

4.1.4 Furthermore, the allocation possibilities can be increased significantly by dividing specific code series into smaller contiguous codes. When this method is used for transit flights bilateral agreement may be required.

## 4.2 SPECIAL PURPOSE CODES

4.2.1 Specific codes in certain series are reserved for special purposes as follows:

---

<b>Series 00</b>	<b>Code 0000 is available as a general purpose code for domestic use by any of the following States:</b>
------------------	--

**Bahrain, Egypt, Iran, Iraq, Jordan, Kuwait, Lebanon, Oman, Qatar, Saudi Arabia, Syria, United Arab Emirates, Yemen.**

<b>Series 10</b>	Code 1000 reserved for use as a conspicuity code for Mode S
------------------	---

<b>Series 20</b>	Code 2000 shall be used by flight crews in the absence of any Air Traffic Control (ATC) instructions or regional agreements unless the conditions for the use of codes: 7000,7500, 7600 and 7700 apply.
------------------	---

<b>Series 70</b>	Code 7000 shall be used by flight crews not receiving ATS service in order to improve detection of suitably equipped aircraft in areas specified by States, unless otherwise instructed by ATS.
------------------	---

<b>Series 75</b>	Code 7500 is reserved for use in the event of unlawful interference.
------------------	--

<b>Series 76</b>	Code 7600 is reserved for use in the event of radio communications failure.
------------------	---

<b>Series 77</b>	Code 7700 is reserved for use in the event of emergencies and interception*. Code 7776 and Code 7777 are reserved for SSR ground transponder monitoring.
------------------	--

<b>Codes 7601-7612</b>	Are reserved for humanitarian flights.
------------------------	--

<b>Common SSR Code Pool</b>	The following code blocks have been reserved for tactical allocation to States on a temporary basis to support large scale activities:
-----------------------------	--

---

4.2.2 Discrete codes in the series 00 are allocated to States for use for domestic purposes. States in the MID Region are generally allocated two octal blocks of four-digit codes per State in such a manner that code duplication is avoided at FIR boundaries. The allocation of octal blocks is shown in the CAL.

*\*Note.— The word “interception” in this context does not include intercept and escort service provided, on request, to an aircraft in distress, in accordance with Volumes II and III of the International Aeronautical and Maritime Search and Rescue Manual (Doc 9731).*

### 4.3 TRANSIT CODES

4.3.1 Transit codes are allocated for assignment to transit flights. Aircraft will retain the assigned code within the geographical limits of the MID PA or, in the case of an agreement between States concerned, across the PA boundary.

4.3.2 The allocation of transit codes in the MID Region is based on one PA<sup>1</sup> which has been determined on the basis of the flow of air traffic in the region. It is shown on the Chart at **Appendix A** and includes the following States:

**PA MID** Bahrain, Egypt, Iran, Iraq, Jordan, Kuwait, Lebanon, Oman, Qatar, Saudi Arabia, Syria, United Arab Emirates, Yemen.

4.3.3 Transit codes shall be assigned in accordance with the following principles:

- a) when an aircraft enters the MID PA (either on departure or in flight), it will be assigned a discrete code by the first ATSU concerned at a Variable System Parameter (VSP) of not less than 30 minutes prior to activation of the flight entering the MID PA or when departing, upon ATC clearance delivery or at start up, whichever is later;
- b) each aircraft will keep the original code assigned on entering the MID PA for the entire flight within the PA. Appropriate code protection criteria have to be applied in order to avoid duplication by too early reassignment of the same code. Efforts should be made to reduce the “protection period” while retaining adequate protection. It has been agreed that the normal retention value shall be two hours; and
- c) a code change will be required at the time an aircraft crosses the MID PA boundary, unless special provision has been made for retention beyond the PA boundary.

4.3.4 In establishing the number and series of transit codes for both omni-directional and directional application, account is taken of the following factors:

- a) the air traffic flows and main sources of transit traffic in the MID Region and likely trends;
- b) the requirement for code series for a given ATC Unit. This requirement is derived from the total number of aircraft requiring assignment of a specific code during the busiest period of activity of that ATC Unit, taking into account a “protection period” after which any specific code assigned to an aircraft by an ATC Unit is normally available for reuse; and
- c) the assignment of a specific code to an aircraft is ideally made, as late as possible before take-off, normally on start up or upon ATC clearance delivery, whichever is later or, when an aircraft in flight is imminently due to come under control, normally a VSP value of not less than 30 minutes.

4.3.5 The distribution of the available code series for transit purposes is shown in the CAL.

4.3.6 Specific arrangements are required to ensure that no conflicting situations will arise in border areas.

### 4.4 DOMESTIC CODES

4.4.1 Domestic codes are allocated for use by aircraft remaining within the boundaries of the agreed area of responsibility (AOR) (normally within one State) or, in the case of agreement between States concerned, across agreed AORs. Domestic codes can also be used for transit

---

<sup>1</sup> The actual number of PAs to be established will depend on the results of the Secretariat study.

aircraft entering the MID PA and landing at an aerodrome within the AOR of the ATSU that has assigned the SSR code. The relevant code series for domestic purposes are shown in the CAL.

- 4.4.2 Domestic codes should be used so that utmost economy in the number of codes required is achieved. Domestic codes used for terminal purposes or within specified portions of the airspace (sectors) or across national boundaries will be assured protection in these functions from other uses of the same code through suitable systematic or procedural methods.
- 4.4.3 More detailed information concerning the procedures to be used for SSR code assignment can be found in **Appendix B**.

## **5 ORCAM**

### **5.1 OUTLINE OF ORCAM OBJECTIVES**

- 5.1.1 The objectives of ORCAM are:
  - a) to ensure safety by uniqueness and continuity;
  - b) enhance safety;
  - c) reduce workload;
  - d) improve system capacity; and
  - e) increase efficiency.
- 5.1.2 Uniqueness and continuity criteria are intended to provide permanent perceptibility and identification of aircraft with a minimum of errors and interruptions.
- 5.1.3 *Uniqueness*. Depending on system functionality, only one aircraft should respond using a given code in any particular area and at any given time. This provides an unambiguous code/callsign correlation and consequently an easy identification of aircraft.
- 5.1.4 *Continuity*. A code assigned to an aircraft should, whenever possible, be retained throughout the flight. This secures permanent display of aircraft identification.
- 5.1.5 The uniqueness and continuity criteria of ORCAM enhance safety by limiting the likelihood of identification errors. They also assist traffic flows since radar identification and all aspects connected with transfers are facilitated. This results in a reduction of workload (radiotelephony, identification monitoring, etc.) and substantially improves the overall system capacity.
- 5.1.6 In some areas the number of flights could exceed the number of SSR codes available. Some rationalization according to the nature of the flight (short-, medium- or long-haul, domestic, international or transit) and of the capabilities of the system is necessary for the most intensive possible use of codes.
- 5.1.7 Permanent code assignments and allocations based on the aircraft callsign, control position or any other systematic distinguishing features cannot be accepted because of the wasteful effects on the efficiency in use of codes required.

## 6 ORCAM SYSTEM REQUIREMENTS

### 6.1 INTRODUCTION

- 6.1.1 Middle East States are relying on the extensive use of SSR in automated ATC ground systems to ensure uninterrupted aircraft identification and maintenance of radar/flight plan correlation.
- 6.1.2 They have recognized the common availability of specified capabilities in automated ATC ground systems as being essential for:
- a) participation of individual automated ATC units in a cooperative environment;
  - b) application of a common SSR Code assignment method in accordance with the ICAO principles;
  - c) efficient utilization of codes in automated ATC ground systems.
- 6.1.3 This “Statement of essential common capabilities for automated ATC ground systems in relation to the use of SSR” shown in paragraph 6.3 below, lists the capabilities concerned. It should be used by States as the basis to determine the minimum operational specifications for automated ground systems.

### 6.2 GENERAL SYSTEM CONSIDERATIONS

- 6.2.1 The application of automatic data processing in ATC ground systems allows for great freedom in the definition of system capabilities. This freedom should be exploited to:
- a) provide for all essential capabilities related to the use of SSR in the most simple manner having due regard to operational requirements; and
  - b) enable individual automated ATC ground systems to function as part of an inter-operable environment and to comply with agreed conventions facilitating such cooperation (e.g. principles and basic rules for code assignment, code assignment methods etc.).
- 6.2.2 Individual automated ATC ground systems should, as part of an inter-operable environment, be capable of making the maximum use of codes previously assigned by other units controlling the aircraft concerned; i.e. they should not introduce any code changes or if this is impossible in some circumstances, require only the minimum of changes.
- 6.2.3 Taking into account inter-operability of ATC ground systems within the MID Region with others outside that area and the range of codes which may be utilized under such arrangements, automated ATC ground systems should be capable of performing all system functions related to the use of SSR for any 4-digit identity code.
- 6.2.4 Automated ATC ground systems should be designed to allow the use of a minimum number of codes. The application of sophisticated code correlation methods may reduce the number of codes needed in comparison with those required when simpler methods are used.
- 6.2.5 The processing of SSR data in automated ATC ground systems should be aimed at reducing the need for controller intervention.
- 6.2.6 **Appendix C** and **Appendix D** provide greater detail regarding the implications for automation and the development of automated SSR code assignment systems respectively.

### 6.3 ESSENTIAL CAPABILITIES FOR AUTOMATED ATC GROUND SYSTEMS

6.3.1 It is essential that automated ATC ground systems be designed to have certain capabilities in common, based on the assumption that:

- a) the maximum use will be made of previously assigned codes;
- b) only where continuing use of previously assigned codes would give rise to ambiguity, new codes will be assigned in accordance with a suitable common SSR code assignment method;
- c) the prime use of codes will be to facilitate automatic identification, automatic tracking and automatic radar/flight plan data correlation; and
- d) the differentiation of aircraft essential for the execution of these functions can be achieved through the use of a single, adequately protected code per aircraft.

6.3.2 In detail, automated ATC ground systems should be capable of automatic:

- a) ***Exchange of codes:*** in particular of timely transmission to adjacent centres concerned of information on the code previously assigned to flights to be transferred.
- b) ***Assignment of codes:*** in all instances where no previous code assignment has been made or where previous assignments are found to be unsuitable.
- c) ***Processing of SSR code information, including:***
  - i) initiation of automatic tracking of SSR responses;  
*Note.— This does not exclude tracking on the basis of primary radar returns in areas where adequate primary coverage is available;*
  - ii) determination for each code whether it meets the criteria to be established for unambiguous correlation;
  - iii) recognition of any code duplications affecting correlation;
  - iv) proposing action to controllers to resolve code duplications affecting correlation;
  - v) establishment of initial correlation between real-time radar information and current flight plan information on the basis of decoded SSR replies (including Mode C information). Correlation should be achieved sufficiently in advance of the time at which an aircraft enters the area of responsibility of a centre;
  - vi) maintenance of correlation between real-time radar information and current flight plan information on the basis of decoded SSR replies and/or coincidence of flight plan information (route, heading, altitude) or other distinguishing criteria and radar information;
  - vii) storage of code information until a VSP time at which its activation and protection is desired; and
  - viii) activation of stored information for correlation at a given VSP time and/or within a given airspace.



- d) **Display of information including:**
- i) presentation in a suitable manner of decoded SSR replies and/or correlated flight plan information;
  - ii) filtering of information to be displayed on the basis of SSR-derived data (Mode A/C); and
  - iii) indication of code duplications.
- e) **Special codes:** immediate recognition of special codes, as specified on a regional or world-wide basis, as well as maintenance of tracking and correlation of aircraft using these codes.
- f) **Recovery from ground system degradation:** in cases of ground system degradation (excluding display component failure) to the extent that essential SSR-derived information is not displayed, automated ATC ground systems should be capable of restoring all essential information within the shortest possible time. Until full serviceability can be restored, the above aim may necessitate suppression of functions of secondary importance.

DRAFT



**APPENDIX A - PARTICIPATING AREAS**

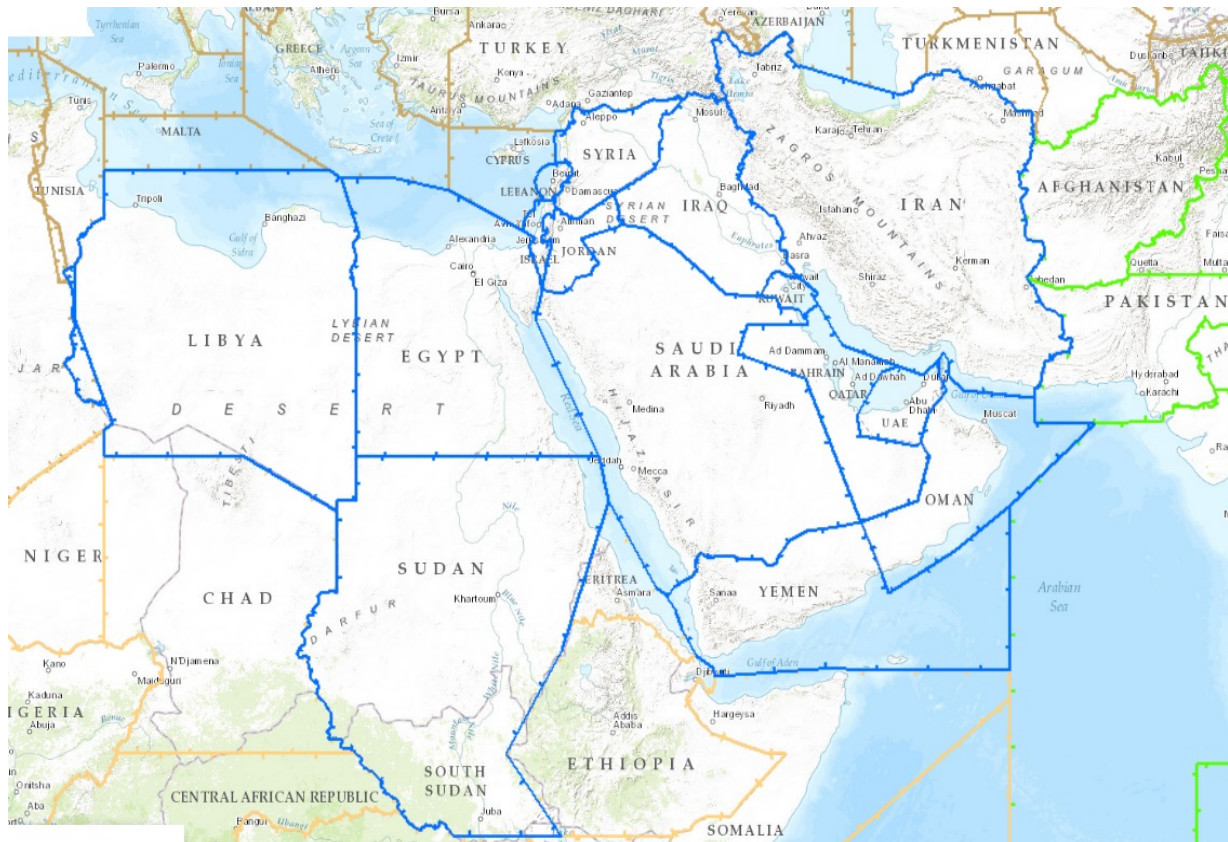

## SSR Code Allocation List

<b>STATE FIR</b>	<b>Domestic Code</b>	<b>Domestic Code</b>	<b>Transit Code</b>	<b>Transit Code</b>
<b>Amman</b>	0400 – 0477 1101 – 1177	2400 – 2477	0700 – 0777	
<b>Baghdad</b>	7400 – 7477	1300 – 1377	1001 – 1077	7200 – 7277
<b>Bahrain</b>	2100 – 2177 2700 – 2777	1200 – 1277	2200 – 2277 4400 – 4477	2600 – 2677 3200 – 3277
<b>Beirut</b>	2500 – 2577		4300 – 4377	
<b>Cairo</b>	0600 – 0677 2700 – 2777	2300 – 2377	1600 – 1677 7300 – 7377	3300 – 3377
<b>Damascus</b>	3000 – 3077		5700 – 5777	
<b>Emirates</b>	0400 – 0477 6000 – 6077	0600 – 0677 6100 – 6177	0500 – 0577 3400 – 3477	1700 – 1777 6200 – 6277
<b>Jeddah</b>	0100 – 0177 3500 – 3577 3000 – 3077	0200 – 0277 5000 – 5077 4100 – 4177	3100 – 3177 5200 – 5277	4500 – 4577 4200 – 4277
<b>Khartoum</b>	1200 – 1277 5200 – 5277	5300 – 5377	0100 – 0177	
<b>Kuwait</b>	0600 – 0677		1400 – 1477	
<b>Muscat</b>	6600 – 6677 4600 – 4677	6500 – 6577	4000 – 4077	4700 – 4777
<b>Sana'a</b>	3700 – 3777		7001 – 7077	
<b>Tehran</b>	1101 – 1177 1500 – 1577 5600 – 5677	4100 – 4177 6300 – 6377	3600 – 3677 5400 – 5477	5100 – 5177
<b>Tripoli</b>	1300 – 1377		4000 – 4077	

### SSR Code Reserve list

<b>Domestic</b>	<b>Transit</b>
0001 – 0077	2001 – 2077
0300 – 0377	5300 – 5377
6700 – 6777	5500 – 5577
7100 – 7177	6400 – 6477
7501 – 7577	
7601 – 7612 Red Cross/humanitarian	
7613 – 7677	
7701 – 7777	

## APPENDIX B - GENERAL PROCEDURES FOR SSR CODE ASSIGNMENT

### B.1 Retention of previous code

- B.1.1 Every endeavour shall be made to retain the code already assigned to the aircraft. This assumes that the code is known at the time of coordination (either by voice coordination or by transmission of an Air Traffic Services (ATS) Interfacility Data Communications (AIDC) message, or an On- Line Data-Interchange (OLDI) or via the pilot) and input into the system if automated. If a code is not already being used by another aircraft flying in an unprotected area and if the code assigned to the aircraft is acceptable for the flight category<sup>2</sup>, the code shall be retained.

*Note.— This should apply if the aircraft comes from an ATSU belonging to the same PA or a unit in another PA, but it may be retained in an area which has no conflicts with the other units in the area.*

### B.2 Code assignment or re-assignment

- B.2.1 The following rules will be applied to departing aircraft within the area of the control unit, or to aircraft whose previously assigned code failed to comply with the rules stated in B.1.1 above and consequently could not be retained:

- B.2.2 Where an aircraft remains inside a defined area of the AOR

Directional assignment of a domestic code - Code C1 can be assigned simultaneously to aircraft A1A2 and A3A4. C1 is protected for zone 1 and zone 2:

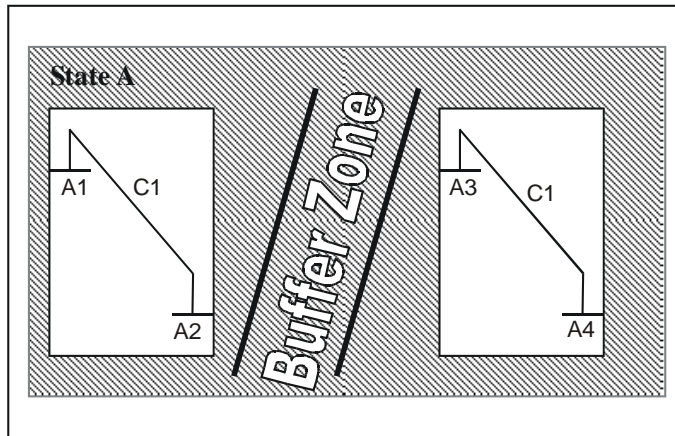

*Note.— Domestic code allocation may be protected by buffer zones of at least 60 NM or separated by another unit. This rule is applicable within States, and also by arrangement between adjacent States. In order to make economic use of this type of allocation the same codes should preferably be disseminated (at most every 120 NM) in different small areas instead of having recourse to allocating codes belonging to an excessive number of different series.*

<sup>2</sup> Flight category refers to transit, domestic or common pool codes.

B.2.3 Where an aircraft remains inside a State

Code C2 can be assigned simultaneously to aircraft A1A2 and B1B2 from different States A and B. C2 is protected for State A and State B:

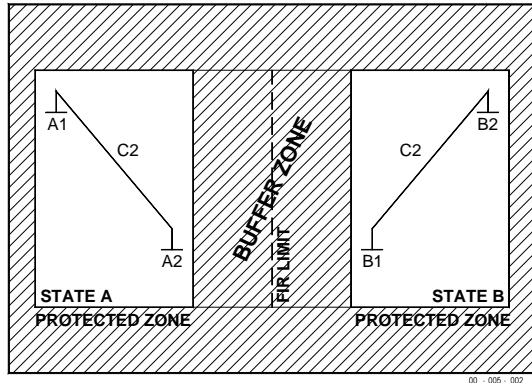

*Note.— Domestic code allocation must be protected by buffer zones. Even more than in the case of B.2.2 above; consultation between adjacent States will be necessary to ensure such protection and rationalize excessive domestic code utilization as far as possible.*

B.2.4 For an aircraft leaving a State

Transit codes are allocated by the Middle East SSR Code Management Plan to the various States for assignment to this flight category. Transit codes should be retained for the remainder of the flight in all States in the same PA and, if possible, other successive PAs, as agreed and reflected in Part B of the CAL. Transit codes received from a previous unit are maintained provided that they satisfy the assignment criteria.

B.2.4.1 *Omni-directional assignment of a transit code*

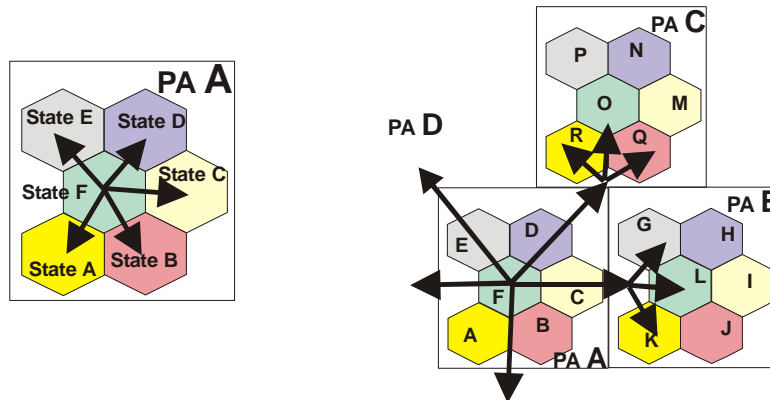

#### B.2.4.2 Directional assignment of a transit code

Allocated by the Middle East SSR Code Management Plan to the various States for assignment to aircraft under specific conditions: to specific destinations in the same PA or in different PAs; to specific directions of aircraft and/or via specific areas. Special attention shall be given in ensuring that when applying directional assignment of a transit code, no code conflict could occur.

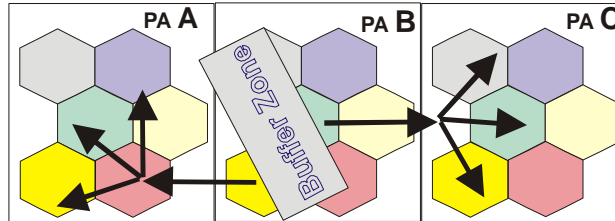

#### B.2.4.3 Close to PA border, retention of transit codes of other PA

Codes C1, C2 and C3, which belong to R2 transit series are retained until landing at an airport A1 near the border between the two PAs, which is located in a protection area for the codes in question.

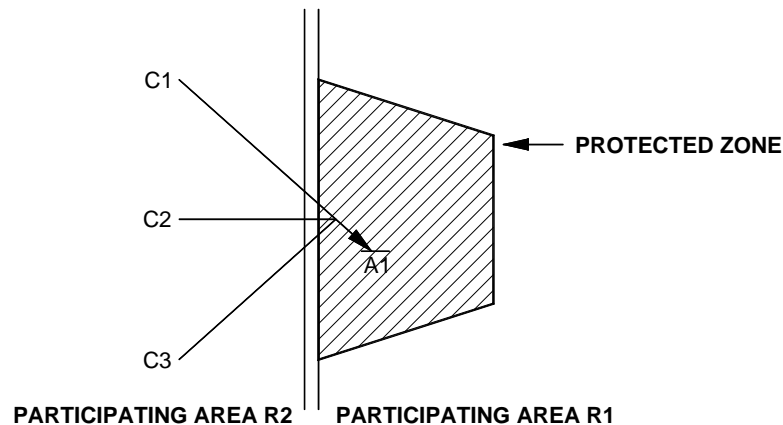

00 - 005 - 005 A

### B.3 Code occupancy times

B.3.1 In order to ensure uniqueness of the code in the systems concerned by an aircraft, the ICAO MID Regional Office based its calculations on a “protection period” of approximately two hours, when establishing the number and series of transit codes (please see paragraph 4.3.4). At the same time, the protection period should be reduced when possible, while providing adequate protection (please see paragraph 4.3.3 b). Certain suggestions along these lines will be found below.

#### B.3.2 Point of time for code assignment to aircraft

In order to economize codes as much as possible, it is recommended that codes be assigned to flights which will be performed in the very near future (when ready for departure, or in flight, about to come under control).

*Note.— The ideal moment is the flight activation point in the case of automated systems.*

B.3.3 Assignment procedures

Codes are normally assigned according to the earliest time of release (a VSP). However, in units assigning codes manually such sophistication may be cumbersome. When sophisticated systems are not available, cyclical assignment of the codes released should be preferred instead of a systematic return to the beginning of the category.

B.3.4 Release of a code by an aircraft

When a system records an aircraft landing or passing a distant MID PA exit point, the code assigned to the aircraft may be regarded as released and be re-used. In the case of distant MID PA exit point, an additional VSP waiting time, normally thirty minutes, shall be added before re-use. In the event that a code has been assigned to flight that has been cancelled or which will not take place, the code assigned should be released for immediate re-use.

B.3.5 Saturation

When the traffic load is such that no code is available for a given flight category it may be necessary to assign codes in accordance with relaxed rules:

- a) reduced protection times –  
(see B.3.4);
  - b) using a different code category –  
using an omni-directional assignment if no more codes for directional assignment
-



### APPENDIX C - IMPLICATIONS FOR AUTOMATION

C.1 As stated in Appendix B, B.1.1, retention of the code assigned by the previous unit requires foreknowledge, implying capture of the data by the system in the event of automated assignment (direct capture by an AIDC or OLDI message, or indirect by manual input on coordination).

C.2 Assignment according to flight category implies that the system is capable of analysing the origin and destination of flights. If not, capture of units transferring and accepting, where applicable, may be used. For some cases one may need to process all four data items.

C.3 As in the case of any problem involving the “queuing management”, it is abundantly clear in the light of the previous remarks that the more centralized the allocation-assignment system, the more economical it will be. In other words, the less call there will be for allotment type solutions (provision of sub-banks to decentralized units), and the greater the use made of central assignment in accordance with overall criteria the more economical the system will be.

C.4 Likewise it has been seen that proper management of the assignment system presupposes knowledge of the actual traffic situation (entry into the system, route, exit from the system-landing etc.). Consequently, it is desirable that the assignment machinery should be linked with the real-time system.

C.5 A number of examples given in Appendix B show that despite the uniqueness by zone criterion, two codes may be found to be in use simultaneously in the same system (radar range is greater than the 60 NM buffer zone). Accordingly, the correlation systems should at least be capable of accommodating and unambiguously identifying two aircraft responding on the same code separated at the time of correlation by a designated geographical distance which will be a function of the automated system.

*Note.— A geographical correlation filter should exist such that correlation will not be achieved if the calculated distance between the flight plan derived position based on estimate information and the SSR response corresponding to the SSR code in the flight plan is more than 30 NM.*

C.6 Illustrative diagram for general code allocation and assignment

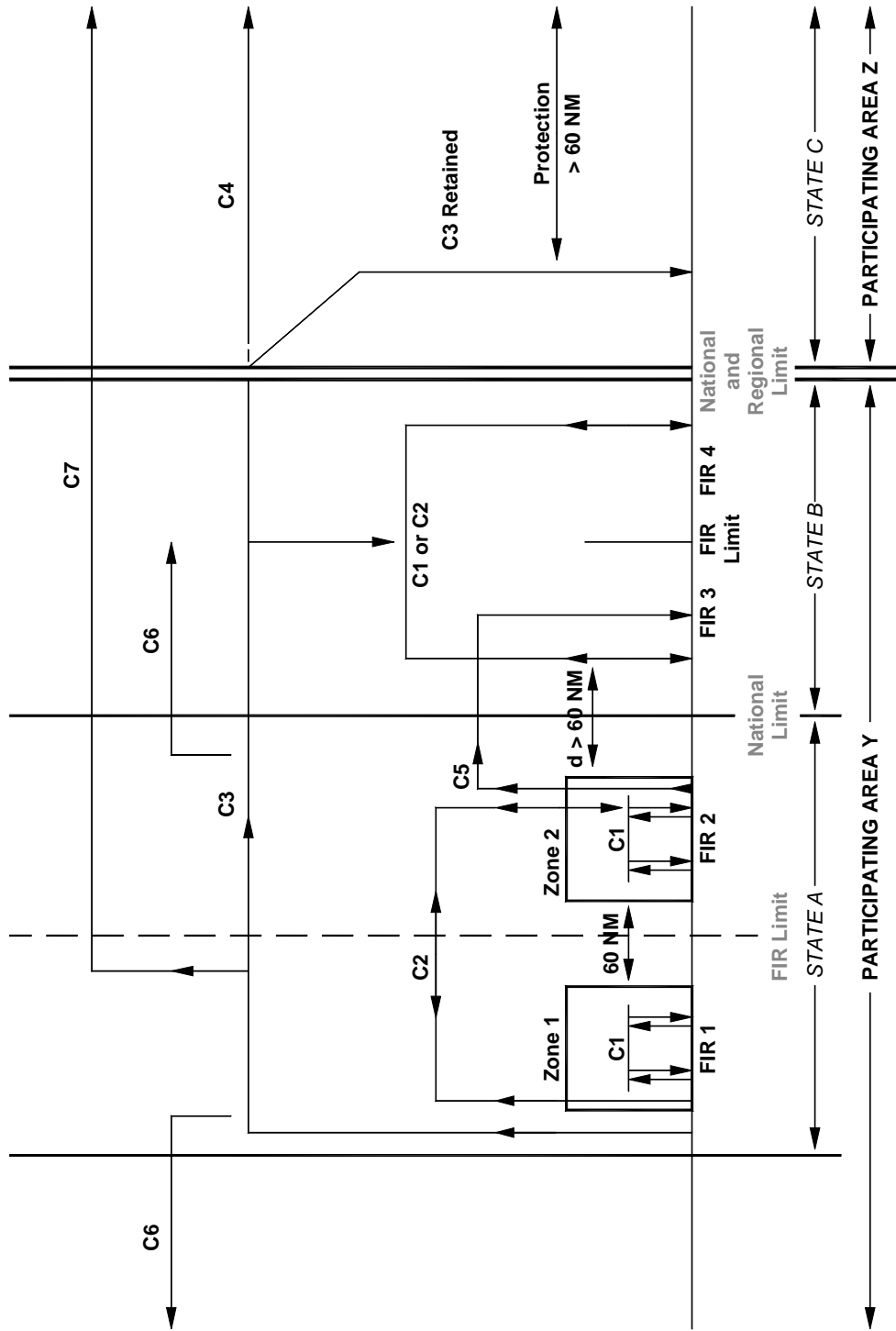

**The following notes relate to the diagram:****Code C1:** Domestic code for PA Y (Domestic in STATE A Domestic in STATE B)

These codes can be used inside zone 1, inside zone 2, inside other zones of STATE B, and even inside the whole territory of STATE B if a buffer zone of 60 NM or a FIR separates them.

These codes could be used in PA Z under the same condition of protection against the allocation in STATE B.

**Code C2:** Domestic code for PA Y (Domestic in STATE A and STATE B)

Condition: a 60 NM buffer zone should be provided between these two assignments.

**Code C3:** Transit code for PA Y (STATE A)

In general such a code should be assigned to any aircraft originated in STATE A and leaving its boundaries, for overflying STATE B or landing in B.

In general this code may be changed at the entry in PA Z, but it could be retained for an arrival at an aerodrome close to the border and having a protection area of at least 60 NM against any other use in PA Z.

If C3 is planned for transit use from PA Y to PA Z it could be retained inside the whole PA Z.

**Code C4:** Transit code for PA Z (STATE C)

Such a code will be assigned to any flight whose code cannot be retained and overflying STATE C for a further destination in PA Z.

**Code C5:** Directional transit code between STATE A FIR2 and STATE B FIR3

C5 should be simultaneously protected in the two FIRs though domestic for PA Y. Such an allocation has the advantage of avoiding assignment of a transit code for such short middle-range flights.

**Code C6:** Transit code for PA Y

The example given with C6 is a duplication where the directional assignment by STATE A gives a guarantee of no conflicts occurring with the following units.

**Code C7:** Transit code for use for PA Y (STATE A) and PA Z

C7 which is at least transit in PA Y and having no domestic use in PA Z will be retained in the two areas.

**Management of the code baskets for STATE A:**

General:	Domestic basket				: C1, C2
	Transit basket				: C3, C6
Special:	Domestic State A	FIR 2	—	State B FIR 3	: C5
	Transit State A		—	PA Z	: C7
	Directional assignment	FIR 2	—	State B	
		FIR 1	—	Other State of PA Y	: C6

C.7 Flow Chart

The following chart outlines the retention/assignment procedures described above:

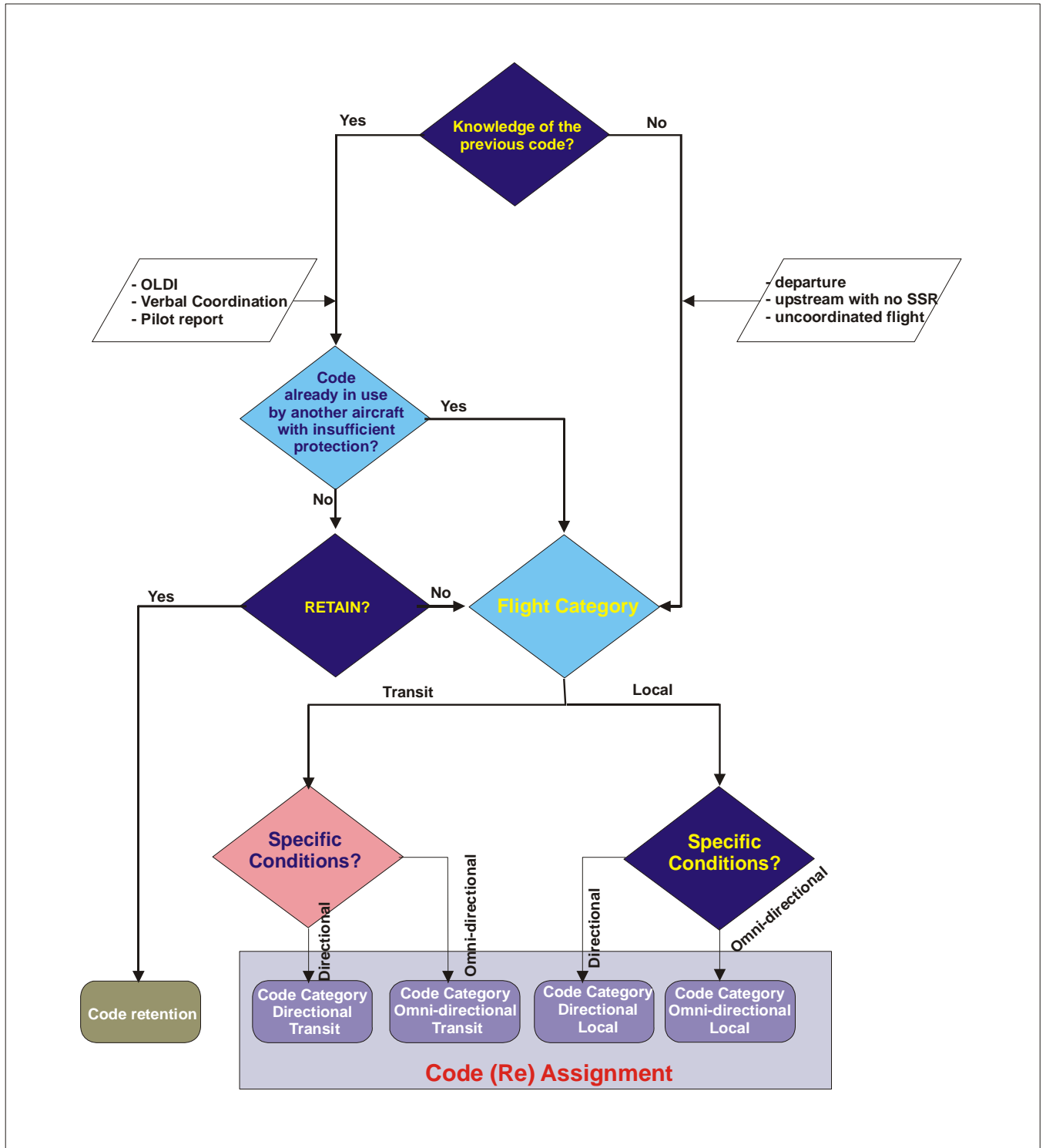

## APPENDIX D - DEVELOPMENT OF AUTOMATED SSR CODE ASSIGNMENT SYSTEMS

D.1 As computer capabilities could be a limiting factor in code assignment and thus reflect on the code allocation, the following principles for the development of automated SSR code assignment systems should be observed:

- a) automated systems shall be capable of using code blocks (part of a code series) without getting confused if, in a neighbouring system, other blocks of the same code series (with the same first and second digits) are used;
- b) automated equipment shall be capable of coping with a limited number of code conflicts rather than preventing code duplications by means of more complicated and less economical code allocation and assignment methods;

*Note.— It is expected that this feature will become even more important as traffic increases.*

- c) automated systems shall be capable of assigning codes with reference to the category of a flight, i.e. transit codes shall be assigned to an aircraft engaged in transit flights and domestic codes to an aircraft confined within the smaller area of use reserved for such codes;
- d) automated systems shall permit the addition of a sophisticated capability of assigning codes with reference to the routing or special code protection required for specific aircraft, especially when this will permit economies in the number of codes required;
- e) the code assignment logic of an automated system shall not impose any restriction on the free choice of any specific additional codes if this is required to satisfy new requirements;
- f) automated code assignment systems shall be designed to conform to international cooperative principles and essential capabilities described in this Document.

-----

**APPENDIX B**

*Allocation and Assignment of Secondary Surveillance Radar (SSR) Codes in the MID Region*

3.1. The Middle East SSR Code Management Plan (MID SSR CMP), endorsed by MIDANPIRG, provides States in the ICAO MID Region with means to coordinate the use of SSR codes based on the provisions of the ICAO Doc 4444 and the principles of the Originating Region Code Assignment Method (ORCAM).

3.2. Certain codes are reserved for special purposes on a world-wide scale. The remaining codes series for use in the Region are divided into two distinct categories: Transit codes (T) for international use and Domestic codes (D) for national use

3.3. The MID Code Allocation List (CAL) at **Table ATM II-MID-2** reflects the assignment of SSR codes to the MID States among the series of codes allocated to the MID Region, based on the number of aircraft to be handled simultaneously within a specified area and for a determined period of protection during traffic peaks.

3.4. The MID SSR CMP, available on the ICAO MID website, under eDocuments ([https://portal.icao.int/RO\\_MID/Pages/eDocs.aspx](https://portal.icao.int/RO_MID/Pages/eDocs.aspx)), should be managed and maintained up-to-date by the ICAO MID Regional Office.

3.5. States should inform the ICAO MID Regional Office promptly of any deviation from the Plan or proposed changes considered necessary with respect to their code allocations, relevant to ATS infrastructure developments and/or the guidance material provided in the MID SSR CMP.

*Special purpose codes*

<b>Series 00</b>	Code 0000 is available as a general purpose code for domestic use by any of the MID States.
<b>Series 10</b>	Code 1000 reserved for use as a conspicuity code for Mode S
<b>Series 20</b>	Code 2000 shall be used by flight crews in the absence of any Air Traffic Control (ATC) instructions or regional agreements unless the conditions for the use of codes: 7000, 7500, 7600 and 7700 apply.
<b>Series 70</b>	Code 7000 shall be used by flight crews not receiving ATS service in order to improve detection of suitably equipped aircraft in areas specified by States, unless otherwise instructed by ATS.
<b>Series 75</b>	Code 7500 is reserved for use in the event of unlawful interference.
<b>Series 76</b>	Code 7600 is reserved for use in the event of radio communications failure.
<b>Series 77</b>	Code 7700 is reserved for use in the event of emergencies and interception*. Code 7776 and Code 7777 are reserved for SSR ground transponder monitoring.
<b>Codes 7601-7612</b>	Are reserved for humanitarian flights.

**Table ATM II-MID-2 – MID SSR Code Allocation List**

Code	AMMAN	BAGHDAD	BAHRAIN	BEIRUT	CAIRO	DAMASCUS	EMIRATES	JEDDAH	KHARTOUM	KUWAIT	MUSCAT	SANAA	TEHRAN	TRIPOLI
0001-0077 <sup>2</sup>														
0101-0177 <sup>1</sup>								D	T					
0200-0277 <sup>1</sup>								D						
0300-0377 <sup>2</sup>														
0400-0477 <sup>2</sup>	D						D							
0500-0577 <sup>1</sup>							T							
0600-0677 <sup>1</sup>					D		D			D				
0700-0777 <sup>1</sup>	T													
1000-1077 <sup>1</sup>		T												
1101-1177 <sup>1</sup>	D												D	
1200-1277 <sup>1</sup>			D						D					
1300-1377 <sup>1</sup>		D												D
1400-1477 <sup>1</sup>										T				
1500-1577 <sup>1</sup>													D	
1600-1677 <sup>1</sup>					T									
1700-1777 <sup>1</sup>							T							
2001-2077 <sup>3</sup>														
2100-2177 <sup>1</sup>			D											
2200-2277 <sup>1</sup>			T											
2300-2377 <sup>1</sup>					D									
2400-2477 <sup>1</sup>	D													
2500-2577 <sup>1</sup>				D										
2600-2677 <sup>1</sup>			T											
2700-2777 <sup>1</sup>			D		D									
3000-3077 <sup>1</sup>						D		D						
3100-3177 <sup>1</sup>								T						
3200-3277 <sup>1</sup>			T											
3300-3377 <sup>1</sup>					T									
3400-3477 <sup>1</sup>							T							
3500-3577 <sup>1</sup>								D						
3600-3677 <sup>1</sup>													T	
3700-3777 <sup>1</sup>												D		
4000-4077 <sup>1</sup>										T				T
4100-4177 <sup>1</sup>								D					D	
4200-4277 <sup>1</sup>								T						

B-3

Code	AMMAN	BAGHDAD	BAHRAIN	BEIRUT	CAIRO	DAMASCUS	EMIRATES	JEDDAH	KHARTOUM	KUWAIT	MUSCAT	SANA'A	TEHRAN	TRIPOLI
4300-4377 <sup>1</sup>				T										
4400-4477 <sup>1</sup>			T											
4500-4577 <sup>1</sup>								T						
4600-4677 <sup>1</sup>											D			
4700-4777 <sup>1</sup>											T			
5000-5077 <sup>1</sup>								D						
5100-5177 <sup>1</sup>													T	
5200-5277 <sup>1</sup>								T	D					
5300-5377 <sup>3</sup>									D					
5400-5477 <sup>1</sup>													T	
5500-5577 <sup>3</sup>														
5600-5677 <sup>1</sup>													D	
5700-5777 <sup>1</sup>						T								
6000-6077 <sup>1</sup>							D							
6100-6177 <sup>1</sup>							D							
6200-6277 <sup>1</sup>							T							
6300-6377 <sup>1</sup>													D	
6400-6477 <sup>3</sup>														
6500-6577 <sup>1</sup>											D			
6600-6677 <sup>1</sup>											D			
6700-6777 <sup>2</sup>														
7001-7077 <sup>1</sup>												T		
7100-7177 <sup>2</sup>														
7200-7277 <sup>1</sup>		T												
7300-7377 <sup>1</sup>					T									
7400-7477 <sup>1</sup>		D												
7501-7577 <sup>2</sup>														
7613-7677 <sup>2</sup>														
7701-7775 <sup>2</sup>														

T: codes allocated for Transit use

D: codes allocated for Domestic use

 <sup>1</sup> Series allocated to the MID Region and Assigned to MID States

 <sup>2</sup> MID Region SSR Reserve List for Domestic use

 <sup>3</sup> MID Region SSR Reserve List for Transit use



APPENDIX C

Request for Temporary/Permanent SSR Codes

State: -----

Date of request: -----

Name of Unit Requesting SSR Code: -----

Number of Codes Required: -----

Purpose: -----

Duration: -----

**Notes:**

- 1- The official request from States DG should be sent to the ICAO MID Regional Office Director and copied Email: [icaomid@cairo.icao.int](mailto:icaomid@cairo.icao.int) or Fax: +2022674843
- 2- The temp assigned codes will be automatically withdrawn after the specified duration date.

- END -