



ICAO Handbook on Radio Frequency Spectrum Requirements for Civil Aviation (2)

Frequency assignment planning for VHF COM systems

Workshop

Peru, Lima, 6 – 10 March 2017

Robert Witzen
Loftur Jónasson

Vol. II – Ch2 – VHF COM systems

Interference model (co-frequency separation (1))

- Conforms to the general methodology in Chapter 1
- Model for establishing separation distances to prevent air-to-air interference:

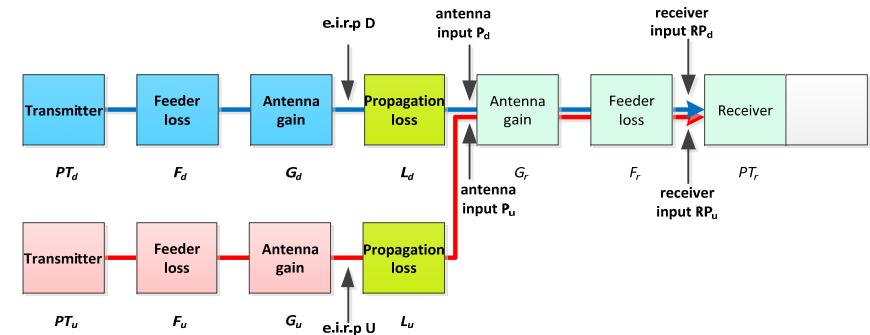
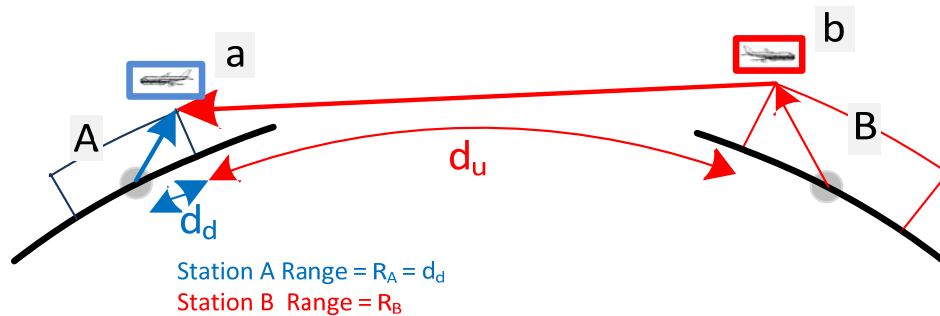

- Minimum separation between stations A and B:
Range A + Radio horizon A + Radio Horizon B + Range B

Vol. II – Ch2 – VHF COM systems

Interference model (co-frequency separation (2))

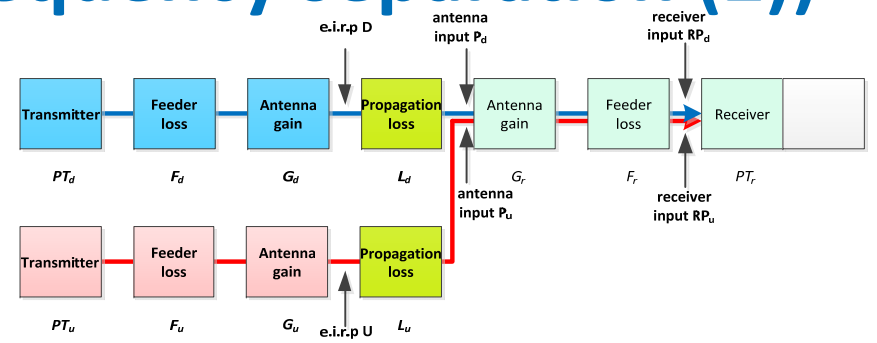
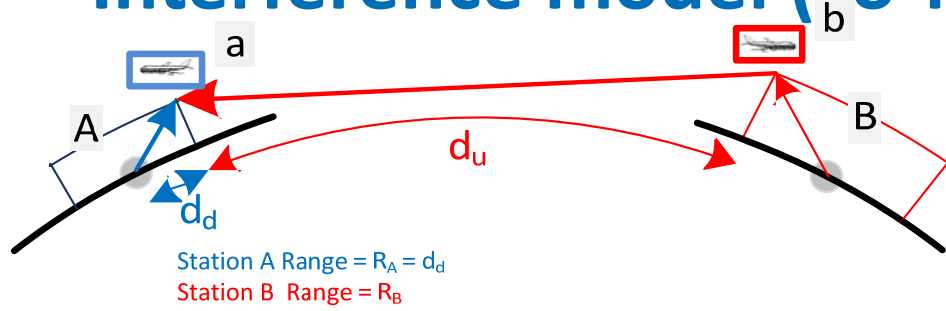

Minimum separation between stations A and B: **Range A + Radio horizon A + Radio Horizon B + Range B**

$$\begin{aligned} \frac{D}{U} &= L_u - L_d \\ &= 37.8 + 20 \log f + 20 \log d_u - (37.8 + 20 \log f + 20 \log d_d) \\ &= 20 \log d_u - 20 \log d_d = 20 \log \frac{d_u}{d_d} \end{aligned}$$

$$\frac{D}{U} = 20 \log \frac{d_u}{d_d}$$

If $d_u = 2 * d_d$ then $\frac{D}{U} = 20 \log 2 = 6\text{dB}$



Vol. II – Frequency assignment planning Interference model (co-frequency separation (3))

- Effect of the radio horizon (att. beyond $R_h = 0.5 * D_{LOS}$)

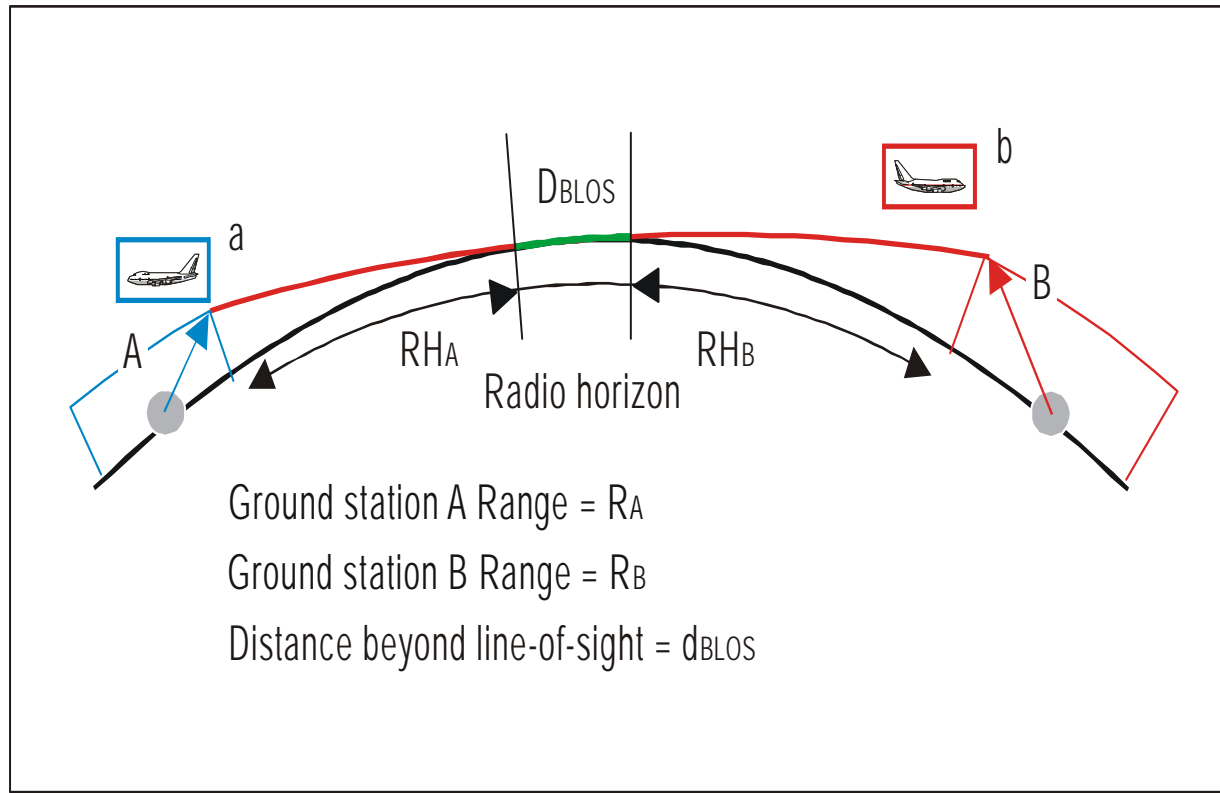



Vol. II – Frequency assignment planning

Interference model (co-frequency separation (1))

– Between Aeronautical broadcast stations
(ATIS, VOLMET)

- Do not involve aircraft transmission
- Separation distances are less compared to both stations providing air-ground communications

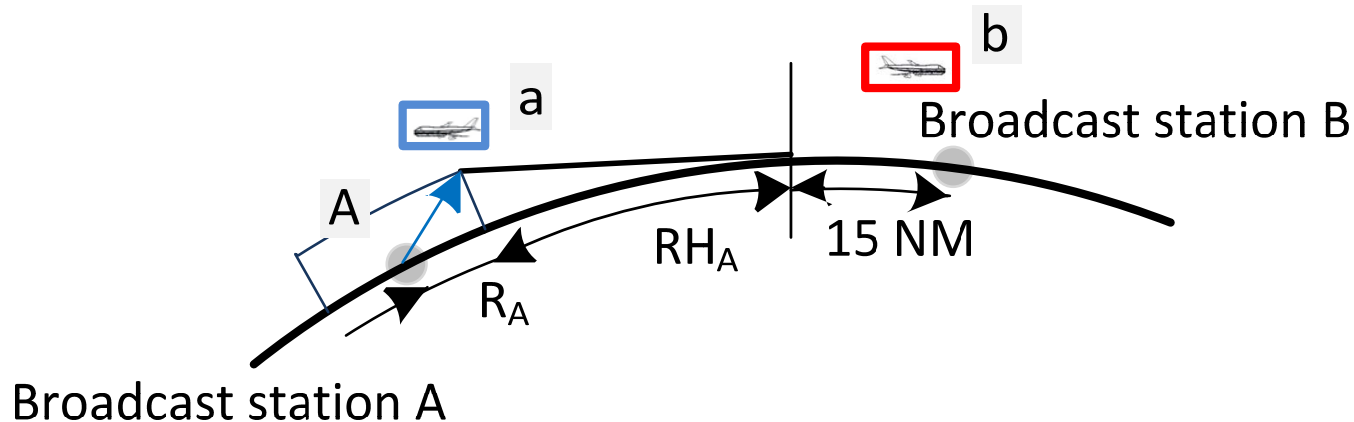



Vol. II – Frequency assignment planning

Interference model (adj-frequency separation (1))

- EUR-FMG has agreed to a revision of adjacent frequency separation criteria
 - Desired and undesired station use 25 kHz channel spacing:
 - 1st adjacent channel no geographical separation required
 - Ground transmitting and receiving stations to be separated by 10 NM
 - Special criteria apply in areas where both 8.33 kHz and 25 kHz channel spacing is used.
- Implemented in Frequency Finder
- Amendment to Handbook in progress



Vol. II – Frequency assignment planning

Interference model (adj. frequency separation (2))

Mixed channel spacing

Station 1 25 kHz channel spacing	Station 2 8.33 kHz channel spacing	
118.000 MHz	118.000 MHz (channel 118.005)	Co-frequency
118.000 MHz	118.0833 MHz (channel 118.010)	1 st adj. frequency (= co-frequency at 25 kHz)
118.000 MHz	118.0167, 118.025, 118.0333 MHz (channels 118.015 – 118.035)	2 nd – 4 th adj. frequency 10 NM between DOC
118.000 MHz	118.0417 MHz (channel 118.040)	5 th adj. frequency No separation required



Frequency assignment planning for VHF air/ground communication systems (1)

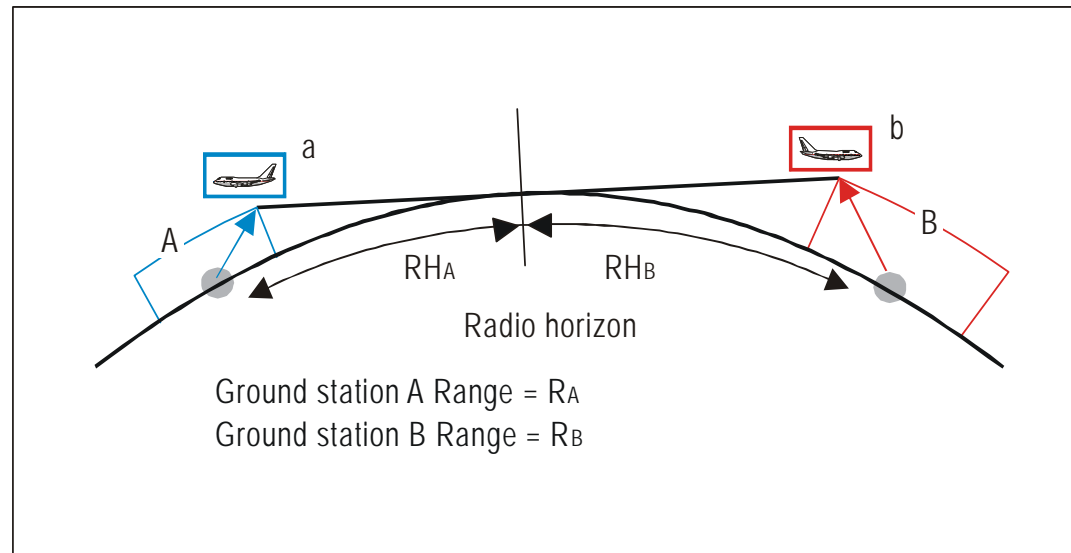

Separation distance between air ground communication services

$$R_A + RH_A + RH_B + R_B$$

Example: A = TWR (25NM, 4000ft) and B = APP-U (150 NM, 45000 ft)

Min. Sep distance = 25+78+150+261=514 NM (between the stations)



Frequency assignment planning for VHF air/ground communication systems (2)

Service	VICTIM												
	Interfer	TWR 25/400	AFIS 25/4000	AS Surface	APP-U 150/450	APP-I 75/250	APP-L 50/120	ACC-U A/450	ACC/L A/250	FIS-U A/450	FIS/L A/250	VOLMET 260/450	ATIS 200/450
TWR		156	156	---	338	273	212	338	273	338	273	338	338

- Example of separation distances required between a TWR Service and other ATC Services
 - Separation distances are between the edges of the relevant Designated Operational Coverage (DOC)

Frequency assignment planning for VHF air/ground communication systems (3)

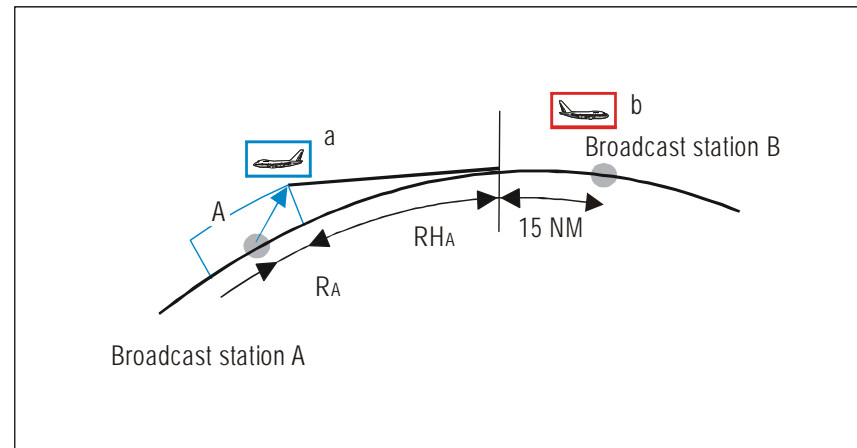

Separation distance between two stations providing aeronautical broadcast services; max range is 200 NM

$$\text{(Max) } R_A + R_{H_A} + 15 \quad \text{or} \quad R_B + R_{H_B} + 15$$

Example: A = ATIS (200NM, 45000ft) and B = VOLMET (200 NM, 45000 ft)

Min. Sep distance = 200+261+15=476 NM (between the stations) or 75 NM between the DOC of the stations

Frequency assignment planning for VHF air/ground communication systems (4)

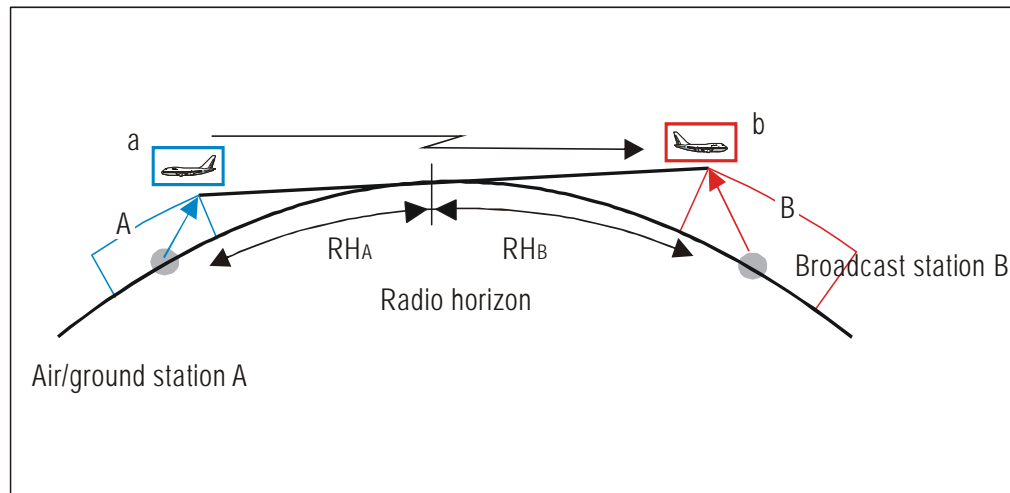

- Separation distance between two stations where one station is for air-ground communication and the other is providing aeronautical broadcast services
- Separation distances are the same as for two stations providing air-ground communications



Frequency assignment planning for VHF air/ground communication systems (5)

		VICTIM											
	Service	TWR 25/4000	AFIS 25/4000	AS Surface	APP-U 150/450	APP- I 75/250	APP-L 50/120	ACC-U Area/450	ACC-L Area/250	FIS-U Area/450	FIS- L Area/250	VOLMET 260/450	ATIS 200/450
INTERFER	TWR	156	156		338	273	212	338	273	338	273	338	338
	AFIS	156	156		338	273	212	338	273	338	273	338	338
	AS (Note 2)			25									
	APP-U	338	338		520	455	394	520	455	520	455	520	520
	APP-I	273	273		455	390	329	325	390	455	390	455	455
	APP-L	212	212		394	329	268	394	329	394	329	394	394
	ACC-U (Note 1)	338	338		520	455	394	520	455	520	455	520	520
	ACC-L (Note 1)	273	273		455	390	329	455	390	455	390	455	455
	FIS-U (Note 1)	338	338		520	455	394	520	455	520	455	520	520
	FIS-L (Note 1)	273	273		455	390	329	455	390	455	390	455	455
	VOLMET	338	338		520	455	394	520	455	520	455	15	15
	ATIS	338	338		520	455	394	520	455	520	455	15	15



Frequency assignment planning for VHF air/ground communication systems (5)

- Frequency planning criteria for VDL were considered by the ACP between 2002 – 2008
- Same methodology as for developing planning criteria for VHF voice systems
- Criteria for VDL (Mode 2 and Mode 4):

		Interference source		
		DSB-AM	VDL 2	VDL 4
Victim	DSB-AM		1	2
	VDL 2	1	1	1
	VDL 4	2	1	1

The Handbook contains specific considerations to be taken into account when using VDL on the surface of an airport.