



**Agenda Item 5: Operational implementation of new ATM automated systems and integration of the existing ones**

**FOLLOW-UP TO THE IMPLEMENTATION OF AIDC INTERCONNECTION BETWEEN ADJACENT ACCs**

(Presented by the Secretariat)

<b>SUMMARY</b>	
<p>This working paper presents information on the activities carried out since the SAM/IG/17 meeting for the operation of AIDC between adjacent ACCs and on the plan of activities for the short term to complete AIDC interconnections at regional and inter-regional level.</p>	
<b>REFERENCES</b>	
<ul style="list-style-type: none"> <li>• Report of the First meeting on AIDC implementation (Lima, Peru, 28-30 March 2016).</li> <li>• Seventeenth workshop/meeting of the SAM implementation group (SAM/IG/17) Lima, Peru, 9-13 May 2016.</li> <li>• Fourth meeting of the GREPECAS programmes and projects review committee (PPRC/4) Lima, Peru, 12-14 July 2016.</li> <li>• Third meeting of air navigation and safety directors (AN&amp;FS/3 Lima, Peru, 22-24 August 2016).</li> <li>• Summary of AIDC teleconferences (from May to September 2016).</li> <li>• Report of the Second meeting on AIDC implementation (AIDC/2 Lima, Peru, 21-23 September 2016).</li> </ul>	
<b>ICAO strategic objectives:</b>	<p><i>A – Safety</i>  <i>B – Air navigation capacity and efficiency</i></p>

**1 Introduction**

1.1 As a follow-up to the implementation of AIDC between adjacent ACCs at regional and inter-regional level, the SAM/IG/17 meeting conducted an initial revision of the Guide for AIDC implementation through the interconnection of automated centres, based on the changes made by the AIDC/1 meeting, and analysed the activities carried out for AIDC implementation (training, testing, pre-operational and operational phases), and the activities to be performed in the short term to complete AIDC interconnections by the end of 2016, as foreseen in the Declaration of Bogota.

## 2 Discussion

### *Guide on AIDC implementation through the interconnection of automated adjacent centres*

2.1 The Second meeting on AIDC implementation (AIDC/2) completed the revision of the *Guide on AIDC implementation through the interconnection of automated adjacent centres*. This guide, developed in April 2013 with the support of Regional Project RLA/06/901, was found by the SAM/IG/11 meeting to be suitable for use in the SAM Region. Since then, the guide is being used as a reference document for the implementation of the AIDC between ATS units in the SAM Region.

2.2 The revised guide introduces updates to several chapters of the document and adds three new appendices: Appendix A, Communications and support mechanisms; Appendix C, Model procedures for conducting AIDC exchange tests; and Appendix D, AIDC operations manual.

2.3 The information contained in Appendix A supplements Chapter II of the guide, providing further information on AIDC communication considerations concerning the header, AFTN priorities, optional data field (ODF), addressing, message identification number, reference information, time stamp, CRC, response time, interpretation of the AIDC header, and performance measurement. Appendix C describes a test protocol for AIDC, which supplements the information contained in Chapter III of the guide, and Appendix D contains the AIDC operations manual, aimed at facilitating the use and operation of the AIDC interface by all the personnel involved.

2.4 Another important change made to the guide is the introduction of two new AIDC messages in the minimum AIDC message set: the PAC and MAC messages. The PAC is the pre-activation message that contains the estimated time of the aircraft over the transfer point or boundary point for a flight that has not taken off yet but is at an aerodrome close to the border (optional use). The MAC is a cancellation message cancelling previous coordination.

2.5 The revised guide is shown in **Appendix A** to this working paper. It is expected that this Meeting will approve it.

### *Activities for the implementation of AIDC between adjacent ACCs*

2.6 Significant progress in the implementation and operational phase of AIDC between adjacent ACCs within Brazil was reported by Brazil at the Third meeting of air navigation and safety directors (AN & FS/3). The following AIDC interconnections were established between May and July 2016:

Curitiba – Recife	July 2016
Recife – Brasilia	June 2016
Curitiba – Brasilia	July 2016
Curitiba – Amazónica	July 2016
Amazónica – Brasilia	June 2016
Amazónica – Recife	May 2016

2.7 Regarding the implementation of AIDC between the Atlántico ACC and adjacent domestic ACCs, Brazil informed the AIDC/2 meeting that it foresaw its implementation by the first half of 2017.

2.8 The AIDC/2 meeting took note that AIDC interconnections between the Lima ACC and the Bogota ACC, the Guayaquil ACC and the Bogota ACC, the Bogota ACC and the Panama ACC, and the Ezeiza ACC and the Cordoba ACC, were still in the pre-operational phase. Taking into account that these interconnections had been in the pre-operational phase for more than one year, the AIDC/2 meeting urged the States involved to migrate from the pre-operational to the operational phase before the end of 2016.

2.9 Regarding AIDC interconnection tests, positive results were obtained between the Iquique ACC and the Cordoba ACC, the Bogota ACC and the Barranquilla ACC, and between Brazil (ATECH test position) and the Lima ACC. The AIDC/2 meeting urges the States to move to the pre-operational phase as soon as possible.

2.10 Regarding inter-regional AIDC interconnections, Panama informed the AIDC/2 meeting that the authorities of the CENAMER ACC had submitted to the Aeronautical Administration of Panama a draft Letter of Operational Agreement between the Panama ACC and CENAMER, which was being reviewed by Panama for signing. Operational tests have been conducted between the Panama ACC and CENAMER using a test protocol defined by the parties, but have not been completed due to failures in the automated system (THALES Top Sky) at the Panama ACC. An update of the automated system at the Panama ACC is to be completed on the first quarter of 2017. It is expected that the AIDC between the Panama ACC and CENAMER will be in the operational phase by the end of the first half of 2017. Panama also reported that coordination had started between Panama and Jamaica for AIDC implementation between the Panama ACC and the Kingston ACC.

2.11 Panama informed the AIDC/2 meeting that the ATC personnel of the Panama ACC had expressed their full confidence on the automated data transfer system, because they have determined that the AIDC significantly reduces controller workload. They suggest its use despite constant message flow interruptions due to the automated system of the Panama ACC.

2.12 Regarding inter-regional AIDC, it is important to take note of initial coordination between the SAM and AFI Regions in order to comply with the requirements for AIDC implementation between the two Regions. In this sense, it was felt that technical trials should be conducted in mid October 2016 through the AFTN connection on the CAFSAT satellite network between Argentina and South Africa, and between Brazil and South Africa.

2.13 **Appendix B** to this working paper contains a detailed table showing the status of implementation of AIDC in the SAM Region, as updated at the AIDC/2 meeting. **Appendix C** contains the plan of activities for AIDC implementation, and **Appendix D** lists the focal points for AIDC implementation coordination, for its revision by the Meeting.

*Other aspects concerning AIDC operation between adjacent ACCs*

2.14 The AIDC/2 meeting recognised the efforts made by Brazil for the operational implementation of AIDC between its domestic ACCs, and its willingness to complete trials and to commission the AIDC between the Curitiba and Amazónico ACCs with all the adjacent ACCs of the Region, in accordance with the timetable of activities contained in Appendix C to this working paper. Likewise, the meeting expressed its concern for the delay in these implementations and the implications for States if this delay were to continue, considering the investments made in equipment and training of the personnel involved to meet the regional commitments assumed by all the States of the Region in the Declaration of Bogota to improve safety in the Region. In this sense, the AIDC/2 meeting urged the States of the Region to comply with the commitments assumed in the Declaration of Bogota, and to carry out AIDC activities on the dates agreed and listed in Appendices B and C to this working paper.

*Status of implementation of AIDC interconnections, in accordance with the Declaration of Bogota*

2.15 Taking into account AIDC interconnections in the operational and pre-operational phase, the meeting took note that 11 AIDC interconnections had been implemented so far, accounting for 73.33% of all (15) AIDC implementations foreseen and contemplated in the Declaration of Bogota.

2.16 It should be noted that, out of the 11 AIDC interconnections, 6 correspond to AIDC interconnections between domestic ACCs in Brazil. It is important to increase the number of AIDC interconnections between the States of the Region.

2.17 In this regard, the Third Meeting of Air Navigation and Safety Directors reported that the pending AIDC interconnections would be completed by the end of 2016, in order to comply with the Declaration of Bogota and thus contribute to operational improvement and safety enhancement at the State and regional level.

**3 Suggested action**

3.1 The Meeting is invited to:

- a) take note of the information presented herein;
- b) analyse the aspects contemplated in section 2 of this working paper and its respective appendices;
- c) approve the amendments made to the Guide on AIDC implementation through the interconnection of adjacent automated centres, shown in Appendix A to this working paper;
- d) comply with the dates for the execution of AIDC activities, as indicated in Appendices B and C to this working paper; and
- e) update the list of AIDC focal points contained in Appendix D to this working paper.

-----

**APPENDIX A**

**International Civil Aviation Organization**

**SAM Region**



**GUIDE FOR THE IMPLEMENTATION  
OF AIDC  
THROUGH THE INTERCONNECTION  
OF  
ADJACENT AUTOMATED CENTRES**

*Lima, Peru – September 2016*

**TABLE OF CONTENTS**

INDEX ..... 2

REFERENCES ..... 4

PURPOSE ..... 5

SCOPE ..... 5

**CHAPTER I** ..... 6

1. GENERAL ..... 6

1.1. Introduction ..... 6

1.2. Capacity and growth ..... 6

**CHAPTER II** ..... 8

2. TECHNICAL ASPECTS FOR THE IMPLEMENTATION OF AIDC BETWEEN  
ADJACENT AUTOMATED SYSTEMS ..... 8

2.1. Introduction ..... 8

2.2. Communication considerations for the interconnection of automated centres ..... 8

2.3. Phases to be taken into account for the implementation of AIDC between adjacent  
automated centres of different States ..... 12

2.4. Prepare the memorandum of understanding between the States ..... 12

2.5. Provision of connectivity between an AMHS server or AFTN CCAM or dedicated  
channel and the automated system ..... 12

2.6. Establish physical and logical connectivity between States ..... 14

2.7. Possible scenarios ..... 15

2.8. Create the required AMHS or AFTN user accounts (mailbox) ..... 18

2.9. Verify the user accounts ..... 20

2.10. Incorporate user accounts to the automated systems that support AIDC ..... 20

2.11. Establish a test protocol ..... 20

2.12. Conduct pre-operational tests ..... 21

2.13. Conduct operational tests ..... 21

2.14. Establish and define the definitive operating stages ..... 21

2.15. Associated automation functionality ..... 21

2.16. Solutions or recommendations in case of failure or recovery ..... 22

2.17. Security considerations ..... 22

2.17.1. Privacy ..... 22

2.17.3. Authentication ..... 23

2.17.4. Access control ..... 23

2.18. Performance considerations ..... 23

2.19. Availability and reliability ..... 24

**CHAPTER III** ..... 25

3. OPERATIONAL ASPECTS FOR THE IMPLEMENTATION OF AIDC BETWEEN  
ADJACENT AUTOMATED SYSTEMS ..... 25

3.1. Introduction ..... 25

3.2. Letter of Operational Agreement ..... 25

3.3. Minimum AIC message set ..... 26

3.4.	AIDC procedures.....	26
3.4.1.	Notification stage .....	26
3.4.2.	Coordination stage.....	27
3.4.3.	Negotiation stage.....	27
3.4.4.	Transfer stage.....	28
3.5.	Flow chart.....	29
3.6.	Implementation testing phases .....	29
3.6.1.	First phase.....	29
3.6.2.	Second phase .....	30
3.6.3.	Third phase .....	30
3.6.4.	Fourth phase .....	30

**APPENDIXES**

APPENDIX A – Communicaitons and support mechanisms .....	31
APPENDIX B – IPv4 WAN Addressing .....	44
APPENDIX C – Model procedures for conductingAIDC exchange tests .....	45
APPENDIX D – AIDC operations manual.....	50
APPENDIX E – Composition of AIDC messages of the mimimum set .....	74
APPENDIX F – List of acronyms.....	80

## REFERENCES

<b>Document ID</b>	<b>Name of document</b>
ICAO Doc 4444	Air traffic management
ICAO Annex 10, Volume II	Aeronautical telecommunications
ICAO Annex 11	Air traffic services
ICAO Doc 9694	Manual of air traffic services -Data Link Applications (Part VI)
ICAO Doc 9880	Manual on detailed technical specifications for the aeronautical telecommunication network (ATN) using ISO / OSI standards and protocols  PART II – Ground-ground applications Air Traffiffic Services Message Handling Services (ATSMHS)
CAR/SAM/ICD	Interface Control Document for Data Communications between ats units in the Caribbean and South American Regions
Doc. NAT/APAC ICD	Pan Regional (NAT and APAC) Interface Control Document for ATS Interfacility Data Communications (PAN AIDC ICD) - Version 1.0 — September 2014

## **PURPOSE**

The purpose of this document is to serve as a practical guide for the implementation of AIDC between two adjacent automated centres of the SAM Region.

The development of this document for AIDC implementation and interconnection is contemplated amongst the activities of Regional Project RLA/06/901, *Assistance for the implementation of a regional ATM system, taking into account the ATM operational concept and the corresponding technological support in communications, navigation and surveillance (CNS)*.

The Fourth edition of the ICAO Global Air Navigation Plan (GANP), in Area 2 on Efficiency Enhancement: *Globally interoperable systems and data*, for increased interoperability, efficiency, and capacity through ground-ground integration, contemplates the implementation of the FICE modules in blocks 0, 1, 2, and 3. FICE block 0 (2013-2018) includes the implementation of AIDC to improve coordination between air traffic service units (ATSUs) through data communication between ATS facilities (AIDC), as defined in the ICAO Manual of air traffic services data link applications (Doc 9694).

The *Performance-based implementation plan for the SAM Region* (PBIP Version 1.4 November 2013), in alignment with the GANP, includes FICE B0 module, considered essential for interoperability and safety.

In the Declaration of Bogota (December 2013), SAM States undertake to implement air navigation and safety priorities during the period 2014-2016. One of these priorities is the implementation of AIDC between adjacent ACCs.

This document will support the States of the Region in the implementation of AIDC through the interconnection of automated systems between adjacent ACCs, and its development was discussed at the Tenth Workshop/Meeting of the SAM Implementation Group (SAM/IG/10), held in Lima on 1-5 October 2012, and approved by the Sixth Coordination Meeting of Project RLA/06/901 (Lima, 21-23 November 2012).

## **SCOPE**

The two main aspects contained in this document for AIDC implementation are:

technical aspects

operational aspects

implemented in a setting of adjacent automated centres.

## CHAPTER I

### 1. GENERAL

#### 1.1. Introduction

1.1.1. One of the key features of the future air traffic management system is the bidirectional exchange of data between the aircraft and the ATC system, and between ATC systems. Communications with the aircraft increasingly tend towards the use of digital data links. At the same time, the automatic exchange of data between ATC systems will support the timely broadcast of flight data, especially for coordination and transfer of flights between ATS units.

1.1.2. The AIDC application shall provide important benefits, including:

- a) Reduced controller workload;
- b) Reduction in the number of read-back/hear-back errors during coordination;
- c) Reduction in the number of gross navigation errors and large height deviations caused by errors in the “controller-to-controller” coordination loop;
- d) Gradual replacement of the ATS speech service as main coordination tool.

1.1.3. AIDC permits the exchange of information between ATS units in support of critical ATC functions. This includes the reporting of flights approaching a border flight information region (FIR), coordination of border crossing conditions, and transfer of control.

1.1.4. The AIDC provides interoperability between automated systems, enabling the exchange of data between ATSUs that are harmonised to a common standard. AIDC supports reporting, coordination and transfer of communications and control functions between these ATSUs. The capacity provided by the AIDC is compatible with a greater flexibility in separation minima applied in the adjacent airspace. The AIDC promotes seamless transfer of aircraft between the participating ATSUs.

1.1.5. AIDC defines the messages related to the three coordination phases as perceived by an ATSU.

- a) *reporting phase*, in which the path of the aircraft and any change may be broadcast to an ATSU from the current ATSU prior to coordination;
- b) *coordination phase*, in which the path of the aircraft is coordinated between two or more ATSUs when the flight is approaching a common border; and
- c) *transfer phase*, in which communications and executive control are transferred from one ATSU to another.

#### 1.2 Capacity and growth

1.2.1 Before implementing this interface between two automated centres, an analysis will be done of traffic expected between the centres. Also, the proposed communication links will be verified to make sure they meet the requirements for this purpose. Traffic estimates must take into account expected, current and future traffic levels.

1.2.2 Furthermore, the strategies developed by the SAM Region for the integration of automated ATM systems based on a safe, gradual, evolutionary and interoperable vision must be adopted. This will facilitate the exchange of information and collaborative decision-making amongst all the components of the ATM system, resulting in transparent, flexible, optimum, and dynamic airspace management.

## CHAPTER II

### 2. TECHNICAL ASPECTS FOR THE IMPLEMENTATION OF AIDC BETWEEN ADJACENT AUTOMATED SYSTEMS

#### 2.1. Introduction

2.1.1. When referring to AIDC-related communications, it should be noted that AIDC is an ATN application used for the exchange of ATS information between two units that have automated centres that support its implementation.

2.1.2. AIDC allows for the exchange of ATS information about active flights, with respect to flight notification, coordination, transfer of control, surveillance data and free text data.

2.1.3. When talking about this automated exchange, we are basically referring to ATS interfacility data communication (AIDC), as defined by ICAO.

2.1.4. Although technical provisions have been defined in various documents cited in this document, the current scenario in the SAM Region calls for an AIDC conceived in function of the means of telecommunication and facilities available in the States.

2.1.5. At present, the SAM Region has different systems and a multiservice platform (REDDIG II) that are optimal and adequate. Consequently, the Region must work on three relevant elements: the concrete use of the AMHS system, the incorporation of automated systems that support AIDC, and a multiservice platform like REDDIG II based on a satellite network and a terrestrial IP MPLS network.

2.1.6. Beyond the various examples we can find --for example, CAR/SAM/ICD and PAN AIDC ICD—for NAT/APAC Regions, this chapter will address the platforms and means that SAM States have or will have available in the short term. In this sense, emphasis will be placed on the AMHS and the ATN IP network for the implementation of AIDC.

2.1.7. It should be noted that the provisions on AIDC are also contained in ICAO Doc 4444, Chapter 11, as well as Doc. 9694 Manual of Air Traffic Services Data Link Applications (Part VI).

2.1.8. Although there are no communication protocols or physical path set for AIDC, different recommendations and practical references will be presented to facilitate implementation.

#### 2.2. Communication considerations for the interconnection of automated centres

2.2.1. First of all, it should be noted that coordination can take place between the following ATSUs: ACC and ACC, ACC and APP, APP and APP, and APP and TWR.

2.2.2. Details about aspects related to of communications on the header, the AFTN priority, data optional field (ODF), addressing, message number of identification, reference information, time stamp, CRC, time of response, interpretation of the AIDC header y measurement of the performance are presented in **Appendix A** to this guide.

2.2.3. It should be noted that, at present, the Plan for the Interconnection of Adjacent Automated Centres of the SAM Region, as relates to AIDC systems between the States, can be implemented in three ways:

- 1) AFTN: message format using the ITA-2 or IA-5 protocol, and using the header field for optional information (Vol. II, Annex 10, 4.4.15.2.2.6). It has a length of 69 characters. Implementation is recommended through REDDIG II node ports. The caveat is that it only accepts the ASCII format.

The typical configuration of an AFTN channel is shown below.

<b>AFTN interface</b>	<b>Parameters</b>
Type	Synchronous - Asynchronous
Data	AIDC
Format	ICAO
Message identity	ABI, CPL, CDN, FPL, EST, ACP, LAM, LRM, RJC, TOC, AOC
Message definition	Ref. Doc 4444
Data speed	9600bps or upper
Physical connection	25 pin type "D"
Electrical characteristics	RS232c V24/V28
Data bits, parity, stop bits, protocol	8 bits, NP, 1 stp, IA-5 / ITA- 2

**Table 1. AFTN channel configuration**

- 2) Dedicated channel (point-to-point): involves the use of dedicated lines that meet safety and performance requirements. It is recommended that this be used through the REDDIG, and depending on the ports to be used.
- 3) AMHS: using the REDDIG II WAN network applying the recommendations concerning the SAM REDDIG IP Plan. It is important to highlight the importance of interconnecting the MTAs between States as a precondition.
- 4) In the case of the AMHS, the required bandwidth is 4,8 Kbps and 14,4 Kbps (taking into account the additional bandwidth) (see Doc SAM ATN – Study on the implementation of a new digital network for the SAM Region (REDDIG II)).

2.2.4. The following graph illustrates a scenario with the different components of an AMHS architecture coexisting with AFTN.

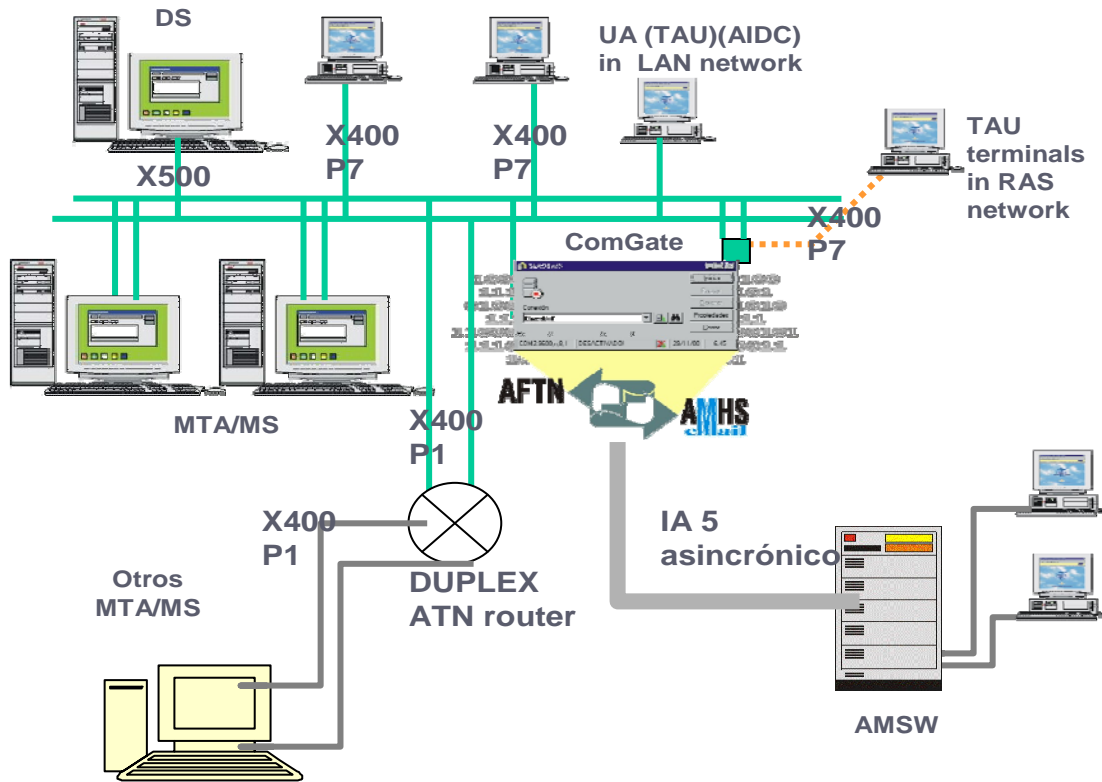

**Graph 1 - AFTN/AMHS scenario (source: Skysoft)**

- UA: User agents (the customers, in this case, AIDC).
- MS: Message storage for handling message delivery and retrieval.
- MTA: Agent responsible for routing messages between MTAs, MSs and UAs.
- P7: Protocol used for retrieval from the MS (ITU-T X.413) (“push” type) by the UA
- P3: Delivery protocol (“pull” type)
- P1: Protocol for communicating and routing messages between MTAs (ITU-T X.411)
- DS: Directory server that communicates using X.500 protocols

2.2.5. Regarding the bandwidth required for the three aforementioned cases, document SAM ATN – Study on the implementation of a new digital network for the SAM Region (REDDIG II)), states the following:

In the case of AFTN and AMHS, “these are AFTN messages generated/received by automated systems, which travel over the respective AFTN or AMHS systems (or a combination of both). Accordingly, the increase in the amount of information will only result as an increase in the number of AFTN messages circulating through the ATN”.

2.2.6. “Since ATS traffic has historically accounted for only 15% of total AFTN traffic, assuming a 3-fold increase (300%) of ATS messages, this will only result in a 30% increase in AFTN traffic”.

2.2.7. In the case of a dedicated link, each centre will send the information to the corresponding adjacent centre, *and the bandwidth will be increased in function of the number of control messages to be generated by each automated centre, which will obviously be a function of surrounding air traffic.*

2.2.8. This ICD mainly refers to the implementation of AIDC based on AMHS and AFTN systems.

2.2.9. AIDC messages will be exchanged through the AFTN and the AMHS. However, AFTN/AMHS gateways shall be used to allow the two systems to continue coexisting, both at present and in the future. Accordingly, these gateways convert AFTN messages to the AMHS format and *vice versa.*



Canal	Descripción	Puerto	Estado	Fecha del estado	Indicativos	T
005	MBB SUMU N4 D3 P9	COM2 :2400 ,...	ACTIVADO	08/06/2007 23:23:34	MBB - BMB	Estanc
006	ABA SGAS N4 D3 P10	COM3 :2400 ,...	ACTIVADO	08/06/2007 23:23:27	ABA - BAA	Estanc
009	SMN N4 D3 P14	COM7 :2400 ,...	ACTIVADO	08/06/2007 23:23:36	SES - ESS	Estanc
014	SKYLINE N4 D3 P12	COM5 :1200 ,...	ACTIVADO	08/06/2007 23:23:20	CAC - ACC	Estanc
018	WEQ CONDOR	COM6 :2400 ,...	ACTIVADO	08/06/2007 23:24:55	WEQ - EWQ	Estanc

**Graph 2 – Channel display for a SAEZ gateway administrator**

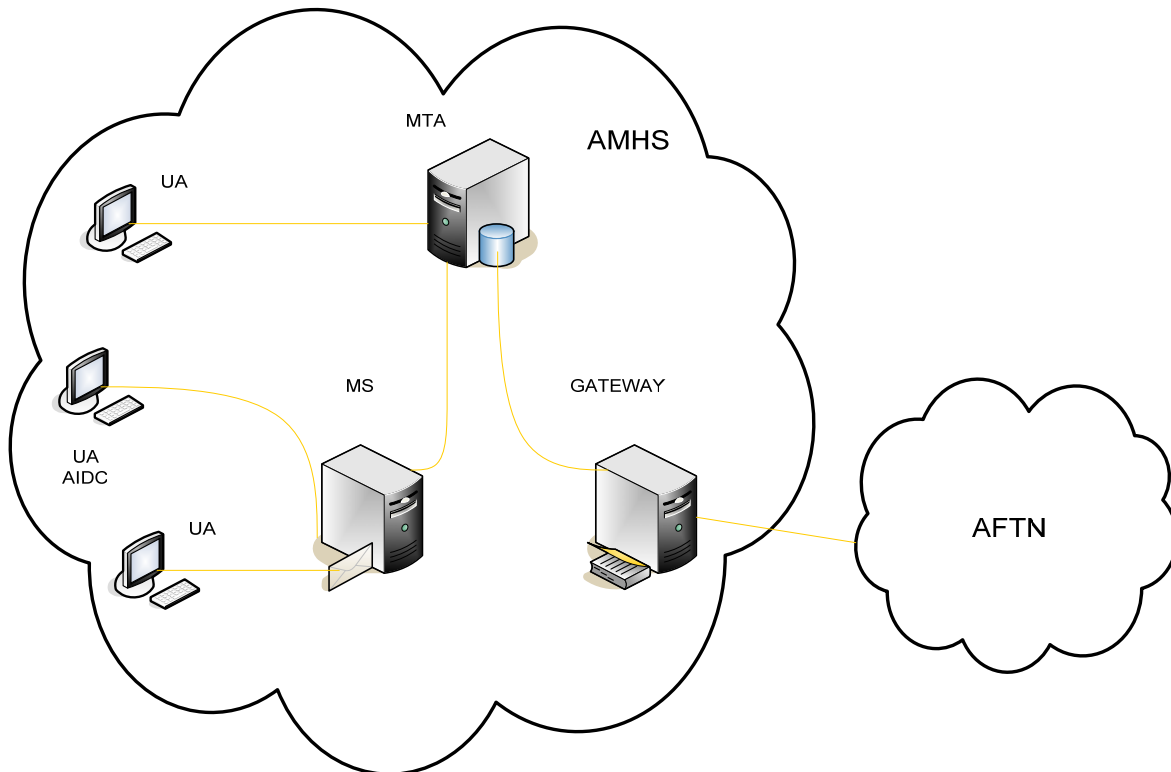

**Graph 3 – Schematic of gateway function**

2.2.10. It should be noted that in 2005, SAM States decided to start replacing their AFTN aeronautical messaging systems with AMHS messaging systems, which have been implemented over IP networks (version 4), especially for the interconnection of MTAs between States.

**2.3. Phases to be taken into account for the implementation of AIDC between adjacent automated centres of different States**

2.3.1. A practical guide on the steps to follow to ensure an effective implementation of AIDC for coordination between adjacent automated centres of different States should take into account the following aspects.

2.3.2. As already stated, this mainly refers to the use of the means already available or to be implemented in the short term in the States.

2.3.3. In conclusion, the following items must be taken into account:

- 1) Drafting of the memorandum of understanding between the States
- 2) Provision of connectivity between the AMHS server or AFTN CCAM or dedicated channel and the automated system
- 3) Establish the physical and logical connection between the States
- 4) Create the required AMHS or AFTN user accounts (mailbox)
- 5) Verify the user accounts
- 6) Incorporate user accounts into the automated systems that support AIDC
- 7) Establish a test protocol
- 8) Conduct pre-operational tests
- 9) Conduct operational tests
- 10) Establish and define definitive operating stages (letters of agreement)

**2.4. Prepare the memorandum of understanding between the States**

2.4.1. First, the States must sign a memorandum of understanding (bilateral agreement) clearly expressing the commitment of the parties to implement the interconnection of automated air traffic systems, especially for AIDC.

2.4.2. Basically, this document must contain the references on which the work will be based; the purpose; the operational, technical, administrative and financial aspects; and everything that the intervening States deem important to include in the document.

2.4.3. It is important to note that, for purposes of the implementation, the States must identify the focal points (coordinators) to be responsible for coordinating the respective work teams to be established as required (that is, technical, operational or technical-operational teams).

2.4.4. These focal points (coordinators) shall be designated by an Interconnection Management Committee, which, in turn, will be composed of a Coordinator, a Technical Group, and an Operational Group.

2.4.5. In this regard see Appendix A showing a model Memorandum of Understanding (MoU) based on the Memorandum of Understanding for Automated Systems.

**2.5. Provision of connectivity between an AMHS server or AFTN CCAM or dedicated channel and the automated system**

2.5.1. The first thing that must be available in each State is the connectivity between the AMHS server, or AFTN CCAM, or the dedicated channel (which is supposedly integrated to its users), whether through a TCP/IP platform, synchronous/asynchronous port, or dedicated channel, respectively. Within this framework, it is understood that the connection between the telecommunication node (that physically hosts the connection that allows linkage with the other State) and the automated system will be achieved through the IP network, or local gateway, or specific cabling, as applicable.

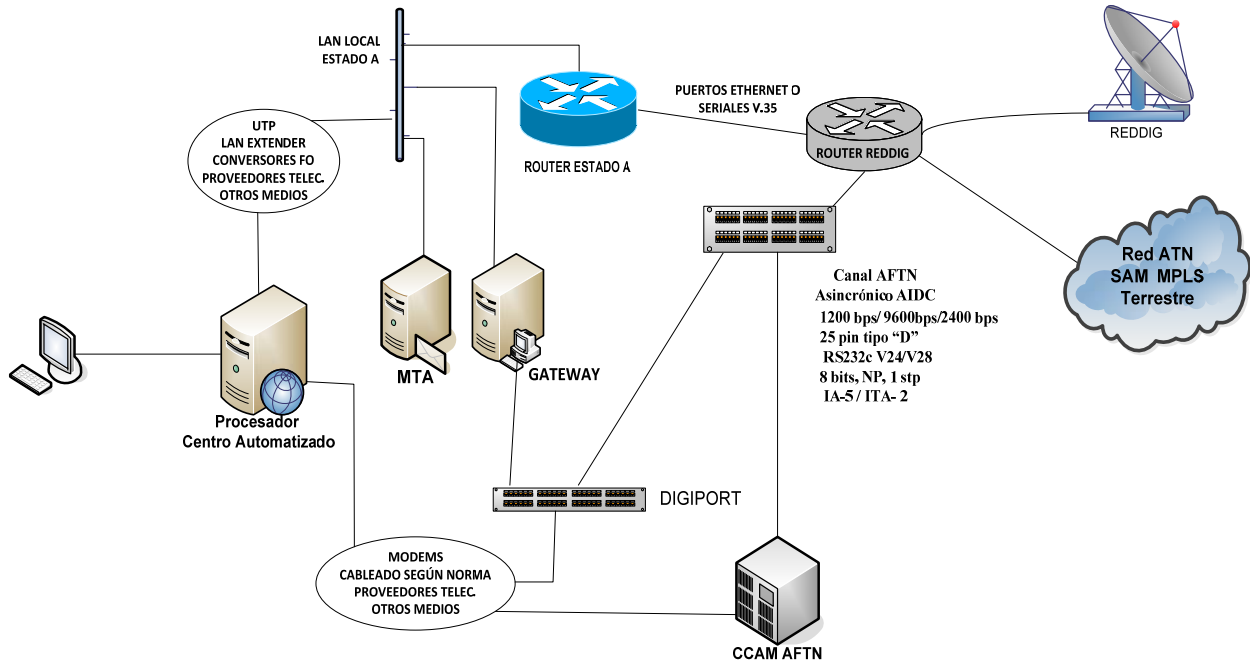

**Graph 4 – Possible last-mile connectivity scenarios**

2.5.2. In this regard, the aforementioned would seem of minor significance, since the respective telecommunication node or server is generally close to the automated centre. But this aspect acquires significance when considering those cases in which structured cabling and physical interface standards (distance factor, cable characteristics, connector, protocol, etc.) demand technical solutions that may require economic resources. For example: State A has a local IP network at the same location as the REDDIG II telecommunication node, and the automated system is located in B, which is in another city or at a distance greater than 100 meters.

2.5.3. In this example, this is an important factor to bear in mind due to technical-administrative timings and the budgetary element involved. This is an important aspect since it could affect implementation times and thus the bilateral agreement.

2.5.4. We know that an automated centre receives the flight plans and it is to be assumed that, given the above scenario, the aforementioned would be no major problem. However, it should be taken into account, especially when talking about point-to-point connections.

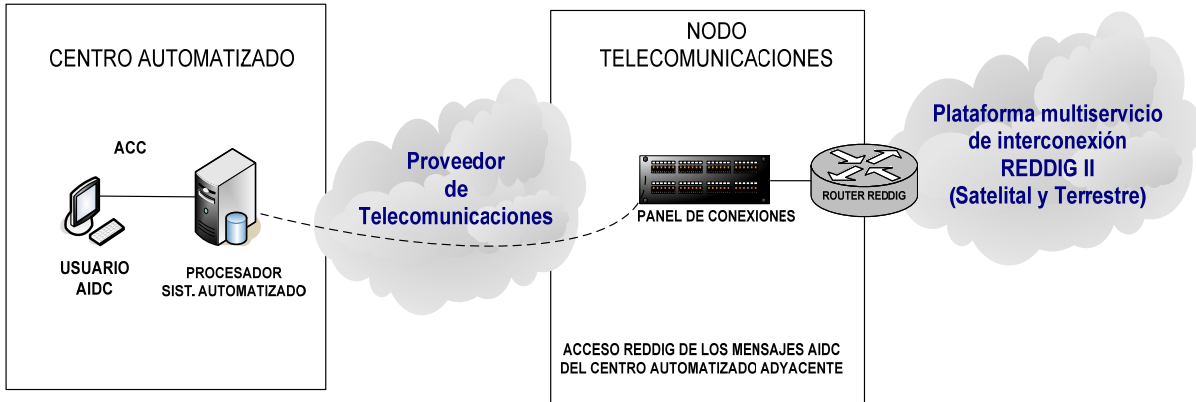

**Graph 5 – Illustration of the case in which the AIDC message telecommunication access node is far from the automated centre**

**2.6. Establish physical and logical connectivity between States**

2.6.1. Once local connectivity is achieved, physical and logical connectivity between the States must be established.

2.6.2. For the completion of this phase, the tools and means available in the SAM Region to implement AIDC between the States are presented below.

2.6.3. *REDDIG II. Regional multi-service platform*

2.6.4. It should be first noted that the REDDIG II is a multi-service platform on which the physical and logical connectivity between States for AIDC must be established. Furthermore, this network currently permits both AFTN and AMHS traffic.

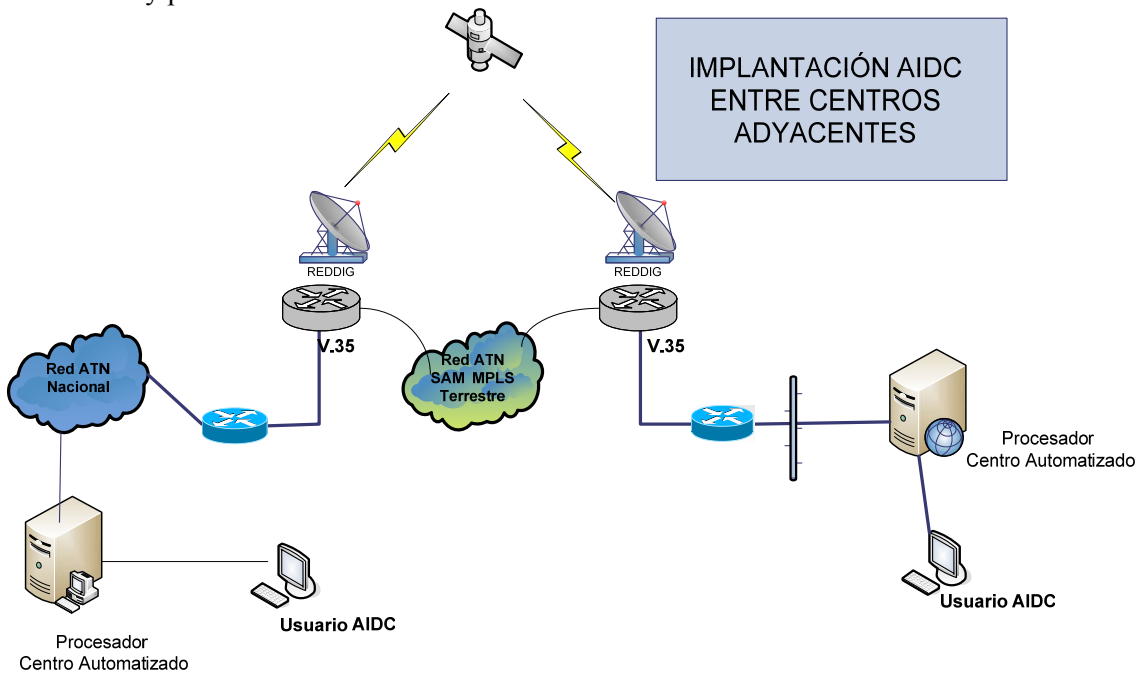

**Graph 6 – Integration of AIDC users of adjacent centres**

2.6.5. In this regard, the definition of connectivity adopted in the Memorandum of Understanding must be taken into account.

2.6.6. Although already mentioned, some considerations and elements to be taken into account when establishing the link between States are iterated below.

2.6.7. For each case, it shall be noted that AFTN channels are normally configured at 9600bps, 8 bits, NP, 1stp, IA-5, synchronous/asynchronous, RS 232c V24/V28, physical connection: 25-pin, type 'D'.

2.6.8. For an AMHS system, the following elements are taken into account: MTA, MS, DS (X.500), gateway to support AFTN channels, CAAS addressing, **message exchange protocols: MTA-MTA: P1 / UA-MS: P7**, users – machines (Flight Data Processor – AU), users – humans (terminals - UA), Mailbox: 2100. The required bandwidth will be 4,8 Kbps and 14,4 Kbps (considering the additional bandwidth).

2.6.9. Likewise, in the case of the AMHS, the reference used is the OSI model, which defines the elements to be taken into account, depending on the layer. For dedicated links, based on the experience of the Region, ports of characteristics similar to those of AFTN channels are used. In this sense, note should be taken of that mentioned in paragraphs 2.2.3, 2.2.4, 2.2.5 and 2.2.6.

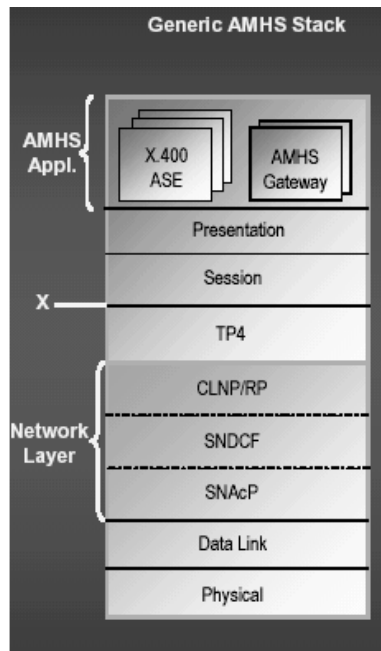

Graph 7 – OSI model reference

## 2.7. Possible scenarios

2.7.1. Currently, most SAM States have incorporated AMHS. In reality however not all States have interconnected their MTAs. Therefore, those States that have AMHS also have an associated gateway that does the conversion from the AMHS “world” to the AFTN “world” and *vice versa*. This is an important issue to be taken into account during AIDC implementation.

2.7.2. *Connectivity through asynchronous ports.* This case may be applied both to a dedicated link or to an AFTN application.

2.7.3. Paragraph 2.6.6 and Doc 9880 must be taken into account.

2.7.4. *Connectivity through an IP network.* Currently, there is a REDDIG IPv4 Addressing Plan in the SAM Region, **Appendix B**, which establishes 8190 IP addresses assigned to each State. It is understood that this availability of addresses would be enough to meet current needs.

2.7.5. Furthermore, the SAM REDDIG IPv4 addressing plan gives flexibility to each State/Territory in the design of its ATN networks and in local implementation of aeronautical applications over IP networks. Likewise, this scheme takes into account future requirements based on address availability.

2.7.6. In order to establish this type of link between States, some physical and logical aspects must be considered.

- a. Follow the REDDIG IPv4 addressing scheme set for the Region.
- b. Identify the physical port to be used for connecting to the networking equipment of the State network (router)
- c. Define, if applicable, the V.35 DCE/DTE interface or protocol
- d. Set the configuration parameters for networking equipment:
  - \* Type of encapsulation
  - \* DLCI for frame relay, or port priority (QoS) for MPLS,
  - \* Type of LMI protocol for frame relay,
  - \* REDDIG WAN IP address (see SAM REDDIG IPv4 addressing plan, Annex C, graph 9).
  - \* REDDIG LAN IP address (see SAM REDDIG IPv4 addressing plan, Annex B, graph 9)
- e. States that have had local addressing prior to the implementation of the SAM REDDIG IPv4 addressing plan or that have not taken it into account shall use NAT (network address translation) or some other mechanism to adapt the national IP network to the regional IP network. See graph 8.

```
AMHS-RT-EZE-03#sh ip nat translations
Pro Inside global      Inside local      Outside local     Outside global
--- ---                ---              ---              ---
--- ---                ---              192.168.48.100   10.0.0.1
--- ---                ---              192.168.104.34   10.0.0.10
--- ---                ---              192.168.104.233  10.0.96.10
tcp 10.0.0.1:102       192.168.48.100:102 10.0.64.2:12341   10.0.64.2:12341
tcp 10.0.0.1:102       192.168.48.100:102 10.0.64.2:16023   10.0.64.2:16023
tcp 10.0.0.1:102       192.168.48.100:102 10.0.64.2:38573   10.0.64.2:38573
tcp 10.0.0.1:102       192.168.48.100:102 10.0.64.2:63718   10.0.64.2:63718
tcp 10.0.0.1:102       192.168.48.100:102 10.0.64.2:64317   10.0.64.2:64317
--- 10.0.0.1           192.168.48.100    ---              ---
udp 10.0.0.10:4001     192.168.104.34:4001 10.0.113.99:4001  10.0.113.99:4001
udp 10.0.0.10:4001     192.168.104.34:4001 10.0.114.99:4001  10.0.114.99:4001
--- 10.0.0.10          192.168.104.34    ---              ---
--- 10.0.96.10         192.168.104.233   ---              ---
```

**Graph 8 – Verification of address translation**

2.7.7. In order to understand address translation between two States, the previous graph shows that IP 10.0.0.1 is consistent with the SAM REDDIG IPv4 plan, and is associated to IP 192.168.48.100,

which is an MTA of Argentina (local IP address of the State ATN), while 10.0.64.2, also consistent with the SAM REDDIG IPv4 plan, is the IP assigned to an MTA of Brazil.

2.7.8. Basically, in order to comply with the above, each State must have the networking equipment (router) that will be connected, on the one hand, to the State LAN and, on the other, to the REDDIG networking equipment (FRAD or router) through a serial port or Ethernet. In this case, the SAM REDDIG IPv4 plan defines the REDDIG WAN and LAN addresses.

2.7.9. The connection scheme described above is shown below.

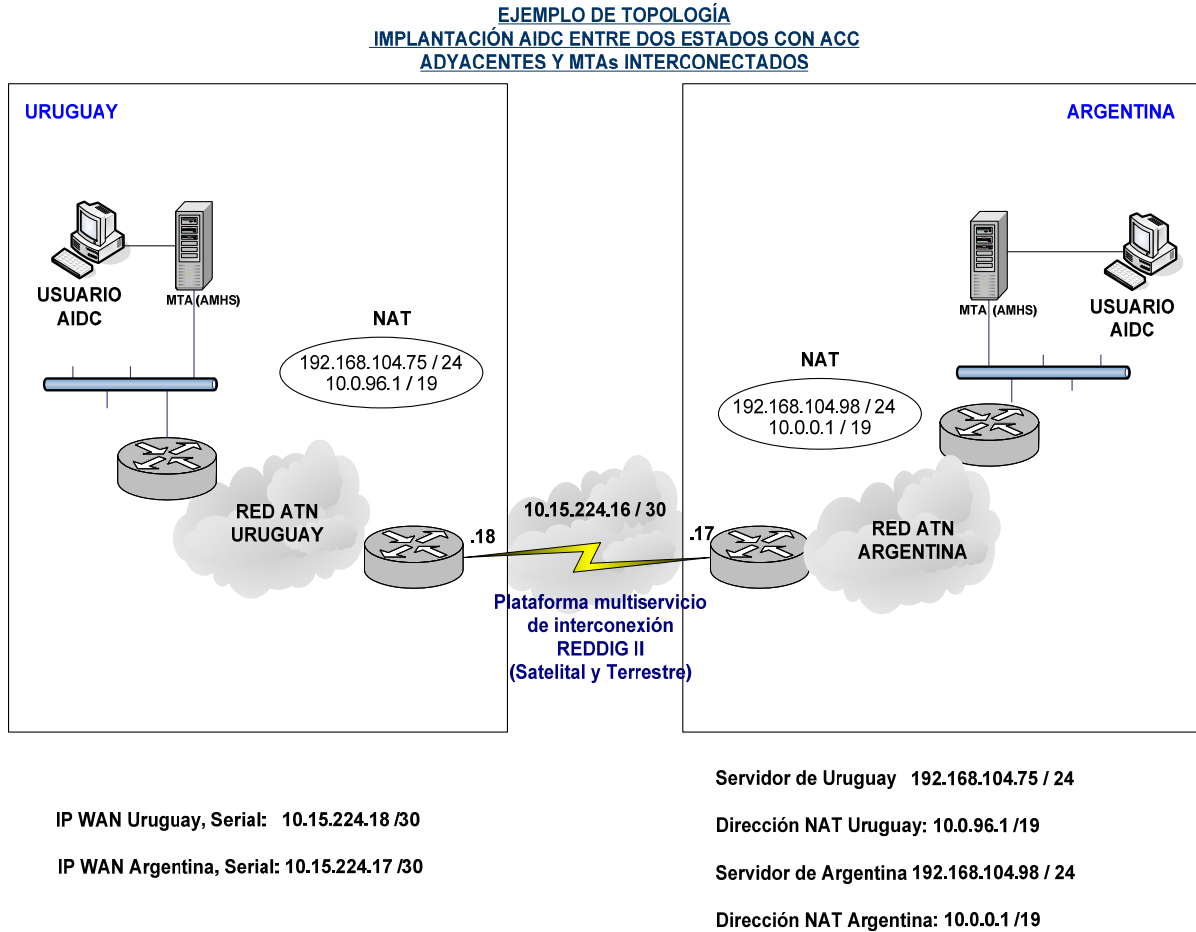

**Graph 9 – Example of AIDC topology using the SAM REDDIG IPv4**

2.7.10. After verifying the connection between the end networking units and the connectivity with the respective local networks, the following phases shall be implemented.

2.7.11. Taking into account the SAM REDDIG IPv4 addressing plan for REDDIG LAN networks (see Appendix A), each State may use the addresses and the addressing scheme of its choice. Nevertheless, a redistribution of network segments is proposed in **Appendix C**.

2.7.12. The purpose of this recommendation is to be able to specify what network segments will be assigned to certain services. It basically means dividing the REDDIG LAN networks of each State into VLANs. But these VLANs must have the same structure in all States.

2.7.13. This recommendation is not only intended for application in AIDC but also in all current and future services to be exchanged between SAM States. It also permits the establishment of a pre-established order that will contribute to an orderly implementation of services (see Annex D to this document).

2.7.14. It is also advisable that:

- 1) Network addresses are assigned in continuous blocks.
- 2) Address blocks are distributed in hierarchical order to enable routing scalability.
- 3) Sub-network configuration is made possible in order to take maximum advantage of each assigned network (subnetting).
- 4) Super-network configuration is made possible in order to take maximum advantage of each assigned network (supernetting)
- 5) The quality of service in an MPLS (REDDIG II) environment is specified.

2.7.15. The only assigned addresses that are known to the rest of the States will be those of the interfaces of the communication equipment used at the *interconnection boundaries* between the internal and external networks of each State.

2.7.16. For the interconnection between their bordering equipment, the States will agree on the routing protocol to be used, unless REDDIG II implementation requires otherwise.

2.7.17. Each State shall ensure routing through its network to the internal address(es) of the application servers it uses *vis-a-vis* other States.

2.7.18. The Regional Office, by virtue of the corresponding institutional arrangements, will coordinate the implementation of the selected *regional routing*.

## 2.8. **Create the required AMHS or AFTN user accounts (mailbox)**

2.8.1. At this point, the user accounts that will operate with AIDC for the interconnection between automated centres must be defined. In this regard, it should be noted that the eight-letter designator would not be affected whether AMHS or AFTN systems are used.

2.8.2. This is relevant for AMHS because the address of the AMHS server must be associated to a REDDIG IPv4 address of the SAM addressing plan. For example: the AIDC user of State A, in addition to its eight-letter address, will be associated to an IP address of the national ATN. When the AIDC user of State A sends an AIDC message to an AIDC user of adjacent State B, the AMHS server will interpret that it is a message for State B. At this point, two things may happen:

- 1) If both States have an AMHS system and the respective MTAs are interconnected, traffic shall be routed through an IP address specified in the SAM REDDIG IPv4 plan and associated to the servers of the States.

- 2) If neither State has AMHS, or one does and the other one does not, or both have it but their MTAs are not interconnected, traffic will be routed to the gateway so that it is transferred to the AFTN world; or will use the assigned AFTN port directly to the destination State. In the case of the AFTN, the channel must be configured in the gateway or AFTN system (data rate, type of channel, standard, type of interface, mode, etc.).

2.8.3. According to the experience in Argentina, it would be required to have at least two user accounts. One will be defined for traffic of AIDC operative messages and the other account for simulation and testing of AIDC traffic and eventually as alternative user account if necessary.

2.8.4. In order to standardise user accounts, this document proposes that the last four letters of the assigned address should be: for AIDC operative traffic messages and CADI for simulation, testing or alternative. In this manner, all the personnel of the States of the Region will readily identify that the message belongs to AIDC and what type of traffic is concern.

2.8.5. Example:

“Assuming the automated centres of Uruguay and Argentina are interconnected, the following addresses will be defined”:

	AFTN/AMHS address for operative traffic	AFTN/AMHS address for simulation testing or alternative
Uruguay	SUMUAIDC	SUMUCADI
Argentina	SAEZAIDC	SAEZCADI

**Table 2. AFTN/AMHS addresses**

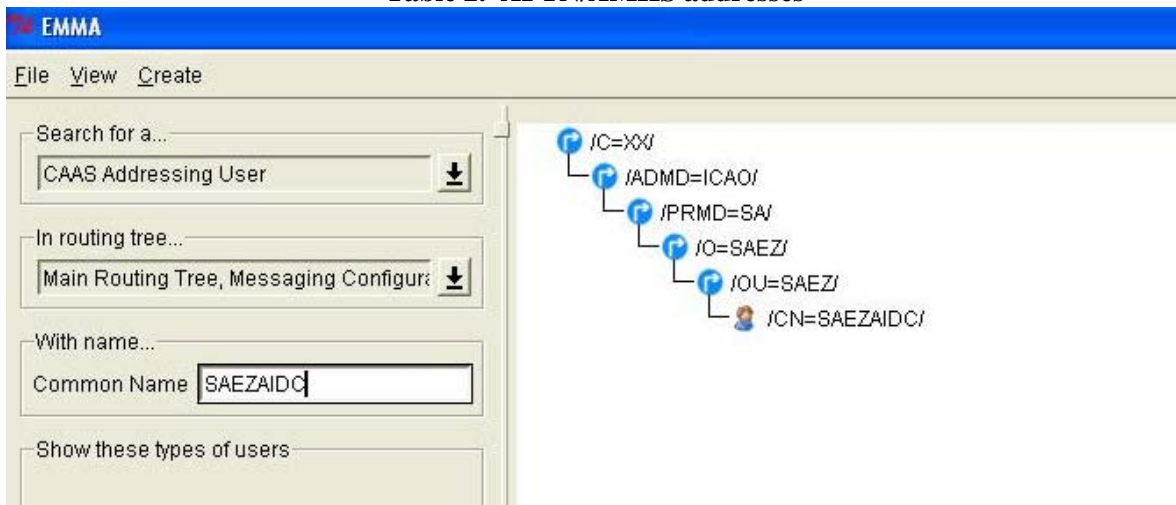

**Graph 10 – Configuration of the AIDC account in the AMHS system**

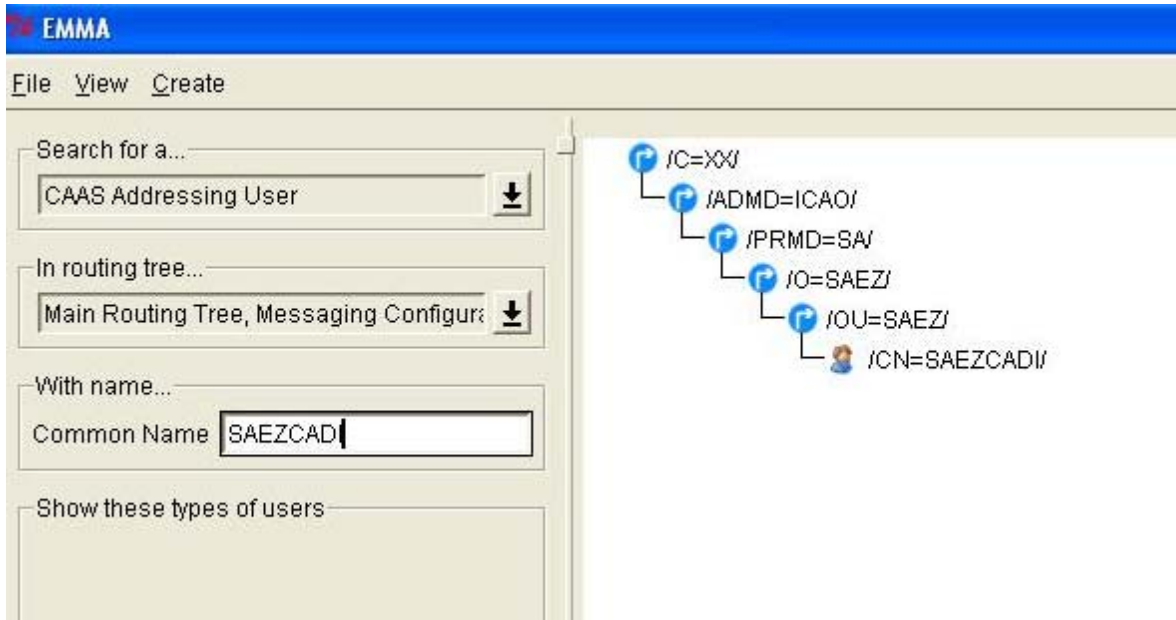

**Graph 11 – Configuration of the CADI account in the AMHS system**

**2.9. Verify the user accounts**

2.9.1. Although the operational verification of user accounts is simple and basic, it is a vital step prior to implementation, where members of the Technical Group and the Operational Group of the Interconnection Management Committee will test the delivery and reception of AIDC messages between AIDC accounts users.

2.9.2. To this end, test AFTN or AMHS terminals must be available and configured as if they were end users (automated systems). See Doc 9880 and Doc 4444.

2.9.3. For message transmission, the AIDC application requires that:

- a) messages be generated and sent in the required time sequence; and
- b) messages be delivered in the order they are sent.

**2.10. Incorporate user accounts to the automated systems that support AIDC**

2.10.1. Once the proper operation of user accounts has been verified, the next step is to coordinate with the technical-operational personnel--which should be part of the Interconnection Management Committee--for their incorporation into the automated systems.

2.10.2. It is recommended that this task be fulfilled preferably in a simulator, if available. More details in this regard are provided in Chapter III of this document, which deals with operational aspects.

**2.11. Establish a test protocol**

2.11.1. Once user accounts have been incorporated into the automated system, the Interconnection Management Committee, which is made up by personnel from both States, will establish a test protocol based on that stated below.

2.11.2 This protocol must cover all aspects related to AIDC operation. In this sense, Annex A contains a general model that must be enriched with the experience gained from various implementations between States.

2.11.3 The development of this test protocol will allow to carry out the pre-operational test which must take place within a safe context to prevent these AIDC messages from entering the operational system that is operating at that moment.

## 2.12. **Conduct pre-operational tests**

2.12.1. The test protocol will permit the conduction of pre-operational tests and all traffic controllers must participate.

2.12.2. During this phase all coordination between concerned ATSU's will be made as usual through speech means and the correct AIDC performance will be verified, making the necessary actions to ensure the continuity of the automatic coordination.

2.12.3. Consideration should also be given to the requirement of informing all stakeholders, as necessary, about the conduction of these tests.

2.12.4. This part of the document is further explained in Chapter III and **Appendix C**.

## 2.13. **Conduct operational tests**

2.13.1. Once the correct operation of the AIDC has been corroborated in the previous stage, the operational test will be conducted. During this phase all coordination between concerned ATSU's will be made through AIDC and speech means will be verified.

## 2.14. **Establish and define the definitive operating stages**

2.14.1. Although more details in this respect will be provided later, it must be noted outright that stages need to be defined. Basically:

- a) in the pre-operational phase, the AIDC will support speech coordination between centres.
- b) in the operational phase, the opposite will occur, where speech communication will support the AIDC system.

## 2.15. **Associated automation functionality**

2.15.1. Each ATS service provider must be required to have the necessary support in each automation system that is implemented or to be implemented in order to be initially capable of:

- Error verification: check all incoming messages for the right format and logical consistency
- Making sure that only messages from authorised senders are accepted and processed
- When necessary, alerting the responsible controller about the flight data received.
- Making sure that the appropriate personnel can configure the logical-automatic response time of a message initiated at the other control unit.

2.16. **Solutions or recommendations in case of failure or recovery**

2.16.1. Automation systems may have different mechanisms for avoiding major failures and for error recovery. Basically, each participating system shall have the following characteristics:

- If the recovery process preserves the current message number at the time of the occurrence, in the sequence established between each intervening system, the notification is not required.
- If the recovery process requires the resetting of the sequence number to 000, a means must be established to notify the receiver unit that message numbers have been reinitiated. This may be established as a procedure agreed between the parties instead of being automated.

2.16.2. Once a LAM is received, if a recovery process takes place following an occurrence, the CPL is not sent automatically, so any CPL for which a LAM had been received must be sent again. This is relevant if the system was able to recover information on the status of coordinated flight plans that have been coordinated and has no need to restore message sequence numbers.

2.17. **Security considerations**

2.17.1. **Privacy**

2.17.1.1. The ICD does not define mechanisms to ensure privacy. It may be assumed that data sent through this interface can be seen by undesired third parties, either by intercepting messages or through disclosure at the receiving centre.

2.17.1.2. All communications that require privacy must be identified, and communications and procedures properly defined. In this sense, it is recommended that mechanisms be used for preserving the confidentiality of information (*e.g.*, firewalls, private networks, trained technical and administrative personnel, etc.). Thus the critical importance of using the REDDIG II as part of a private network.

2.17.1.3. It is also recommended that, during coordination between the States, the security policy to be implemented be taken into account as a determining factor. Even more so if the trend is to use IP networks, regardless of the platform.

2.17.1.4. In order to avoid threats and vulnerabilities, these security policies should be aimed at:

- Protecting confidentiality
- Preserving integrity
- Ensuring availability

2.17.1.5. Security risks cannot be completely eliminated or prevented; however, they can be minimised through effective risk management and assessment. Although the future ATN network supported by the REDDIG II is not available for the non-aeronautical world, it is open to the aeronautical world.

2.17.1.6. ATN network users expect security measures to ensure:

- That users will only be able to carry out authorised tasks.
- That users will only be able to obtain authorised information.
- That users will not be able to damage the data, applications or the operating environment of a system.

- A system that can track user actions and the network resources to which these actions have access.

2.17.1.7. The “safety policy” is key to the implementation not only of AIDC but also of all the services in the Region. Consequently, special attention should be paid to the “Guidance on Safety for the Implementation of IP Networks”, Project D1, SAM ATN Architecture, April 2013.

2.17.2. **Authentication**

2.17.2.1. Each system must verify that messages received are from the source stated in Field 03, which identifies the message type designator, message number, and reference data (see Doc 4444).

2.17.3. **Access control**

2.17.3.1. Each system participating in the interface will implement access controls to ensure that the source of the message is authorised to send a given type of message and that it has the right authority over the flight in question.

2.18. **Performance considerations**

2.18.1. Communication systems. Requirements and parameters

2.18.2. In addition to the requirements specified in this document, all data link applications require that:

- a) the probability of not receiving a message be  $10^{-6}$  or less;
- b) the probability that a message not received is not be notified to the sender be  $10^{-9}$  or less; and
- c) the probability that a message is erroneously routed be  $10^{-7}$  or less.

2.18.3. The figures in Table 3 reflect the various performance levels that may be selected for the provision of data link services. Depending on the level of service to be provided, a State may define its performance requirements based on factors such as separation minima applied, traffic density, or traffic flow.

<b>Application</b>	<b>Availability (%)</b>	<b>Integrity</b>	<b>Reliability (%)</b>	<b>Continuity (%)</b>
DLCI	99.9	$10^{-6}$	99.9	99.9
ADS	99.996	$10^{-7}$	99.996	99.996
CPDLC	99.9	$10^{-7}$	99.99	99.99
FIS	99.9	$10^{-6}$	99.9	99.9
AIDC	99.996	$10^{-7}$	99.9	99.9
ADS-B	99.996	$10^{-7}$	99.996	99.996

**Table 3. Performance requirements**

2.18.4. Except under catastrophic circumstances, and based on the previous parameters, there may only be one end-to-end interruption that shall not exceed 30 seconds. (End-to-end availability can be achieved through the provision of alternate communication routes wherever possible. In this sense, REDDIG II contemplates this scenario).

2.18.5. For flight planning messages, controllers need a failed message transmission indication within 60 seconds of the message being sent. Therefore, the response time from the moment a message is sent until a LAM (or LRM) is received shall be less than 60 seconds at least 99% of the time under normal operating conditions. However, this can vary depending on the requirements of each centre. This may be modified following an analysis to ensure service efficiency.

2.18.6. Consequently, the response time from the moment a message is sent until a LAM (or LRM) is received shall be less than 60 seconds at least 99% of the time under normal operating conditions. A fast response time is desirable and will result in more efficient operations.

2.19. **Availability and reliability**

2.19.1. The software and hardware resources required for providing an interface service to users in the SAM Region must be developed in such a way that reliability is inherent to interface availability, which should be at least the same as that for end-to-end systems (for example, 99,7% availability for the systems at each end, which operate with 99,7% reliability).

### CHAPTER III

## 3. OPERATIONAL ASPECTS FOR THE IMPLEMENTATION OF AIDC BETWEEN ADJACENT AUTOMATED SYSTEMS

### 3.1. Introduction

3.1.1. This application of data communications between air traffic control units is not intended to fully replace voice communications. Initially, it will supplement traditional (voice) communications and will gradually become the main coordination channel, supplemented by speech communication.

3.1.2. The notification, coordination and transfer stages will continue to be the same as those described in ICAO Doc 4444 in Chapter 10, with the difference that, when using an AIDC application, the intervention of the operator will be minimal.

3.1.3. AIDC messages will have the same format and content as those normally used, as shown in ICAO Doc 4444, Chapter 11.

### 3.2. Letter of Operational Agreement

3.2.1. Prior to AIDC implementation, a new letter of agreement between ATC units will be drafted, taking into account aspects concerning how much time in advance will messages be transmitted from one unit to the other.

3.2.2. This agreement between the parties will result in the configuration of each automated system according to the following example:

AIDC	
AIDC SEND TIME (sec) :	1800
ETO DELTA (sec) :	300
INIT TIME (Sec) :	600
INIT DISTANCE (Nm) :	4.7
LAM TIME (Sec) :	60
ACP TIME (Sec) :	120
RENEGOTIATION (Sec) :	120

Graph 12. AIDC configuration

- *AIDC SEND TIME (sec)*: Time before arrival to the ABI message delivery coordination fix.
- *ETO DELTA (sec)*: Difference in the estimated time of flight over the coordination fix that triggers the delivery of a new ABI message.
- *INIT TIME (sec)*: Time before arrival to the coordination fix, which generates an EST message.
- *INIT DISTANCE (Nm)*: Distance to the coordination fix, which generates an EST message.
- *LAM TIME (sec)*: Waiting time of the LAM message.
- *ACP TIME (sec)*: Waiting time of ACP message.

➤ *RENEGOTIATION (sec)*: Waiting time to renegotiate coordination.

3.3. **Minimum AIC message set**

Category	Message	Name	Description
Pre-departure coordination of flights	FPL	Filed flight plan	Flight plan, as filed before the ATS unit.
	ABI	Notification	Notification messages will be sent in advance to ATS units.
Coordination of active flights	CPL	Current flight plan	The flight plan, including changes resulting from clearances.
	EST	Estimate	Time expected to cross the point of transfer or boundary point.
	CDN	Coordination	Proposal of amendment to coordination conditions.
	PAC	Pre-activation	Time expected of passage through the transfer point or boundary point for a flight that still does not take off, but is at an aerodrome near the border (optional use).
	MAC	Cancelation	Cancels the previous coordination
	ACP	Acceptance	Acceptance of proposed coordination or amendment.
	RJC	Rejection	Coordination rejected
Transfer of control	TOC	Transfer	The controller of the transferring unit has instructed the flight to establish communication with the controller of the accepting unit.
	AOC	Acceptance of transfer	The flight has established communication with the accepting controller
Logical	LAM	Logical acknowledgment	Acceptance of application.
	LRM	Logical rejection	Rejection of application.

**Table 4. ATC message set**

3.3.1. **Appendix D** to this document shows the format of messages in the minimum set.

3.4. **AIDC procedures**

3.4.1. **Notification stage**

3.4.1.1. The FPL enters the system and is in pre-notification state.

 (FPL-SAEZ/SACO-ARG1502-IS-A320/M-SW/C-SAEZ1235-N0450F320 ATOVO3B ATOVO UW5 CBA-SACF0055-EET/SACF0037)

This is a flight plan for a flight from the International Airport of Ezeiza, in Buenos Aires to the International Airport of Cordoba, in Cordoba, with a proposed time of departure of 1235 UTC.

3.4.1.2. A predetermined time before the estimated time of passage over the coordination fix, the system sends an ABI. The coordination changes to the notified State.

 (ABI-ARG1502/A1701-SAEZ-UBREL/1330F320-SACO-8/IS-9/A320/M-10/SW/C)

This is the ABI message that the automated system of Ezeiza sends to indicate to the Cordoba automated system that ARG1502 will be in the UBREL position at 1330.

3.4.1.3. The system receives a LAM, confirming that the system of the adjacent centre has a flight plan.

 (LAM)

3.4.1.4. During the notification phase, the system sends an ABI message with each notification about the FPL, receiving a LAM for each ABI sent.

### 3.4.2. **Coordination stage**

3.4.2.1. A given time before the estimated time of passage over the point of notification or at a given distance from it, the system sends an EST message, and the FPL changes to the coordination state.

(EST-ARG1502/A1701-SAEZ-UBREL/1345F320-SACO)

This is an EST message sent by the Ezeiza system to the Cordoba system, notifying that the aircraft is in the air and estimated to arrive at the coordination fix at 1345.

3.4.2.2. The system receives a LAM acknowledging receipt of the EST message.

 (LAM)

3.4.2.3. The operator of the receiving control centre must accept (ACP) or negotiate (CDN) the coordination.

3.4.2.4. If the operator of the receiving control centre accepts the coordination, the FPL changes to the Coordinated state.

 (ACP-ARG1502-SAEZ-SACO)

3.4.2.5. The system receives an ACP and sends a LAM.

 (LAM)

### 3.4.3. **Negotiation stage**

3.4.3.1. If the operator of the receiving control centre renegotiates the coordination (CDN), the FPL changes to the Renegotiation state.

 (CDN-ARG1502-SAEZ-SACO-14/UBREL/0450F340)

This is a CDN message sent by the operator in Córdoba requesting that flight ARG1502 be transferred with FL340.

3.4.3.2. The system receives a CDN and sends a LAM.

 (LAM)

3.4.3.3. The operator of the originating control centre must accept (ACP) or negotiate (CDN) the coordination.

3.4.3.4. If the operator of the originating control centre accepts the coordination (ACP), the FPL changes to the Coordinated state.

 (ACP-ARG1502-SAEZ-SACO)

3.4.3.5. The system sends an ACP and receives a LAM.

 (LAM)

3.4.3.6. If the operator of the originating control centre renegotiates the coordination (CDN), the FPL changes to the Renegotiation state.

 (CDN-ARG1502-SAEZ-SACO-14/UBREL/0450F300)

This is a CDN message sent by the operator in Ezeiza requesting the operator in Córdoba to clear FL300 for ARG1502.

3.4.3.7. The system sends a CDN and receives a LAM.

 (LAM)

#### 3.4.4. **Transfer stage**

3.4.4.1. When the aircraft is close to the coordination FIX, at a distance or under the conditions established in the letter of agreement between the units, the operator of the originating control centre must send a transfer message (TOC). The FPL changes to the Transferring state.

 (TOC-ARG1502/A1701-SAEZ-SACO)

3.4.4.2. The system sends a TOC and receives a LAM.

 (LAM)

3.4.4.3. The operator of the receiving control centre must accept the transfer with an acceptance of transfer of control message (AOC). The FPL changes to a Transferred state.

 (AOC-ARG1502/A1701-SAEZ-SACO)

3.4.4.4. The system receives an AOC and sends a LAM.

 (LAM)

3.4.4.5. Negotiations can be conducted after the transfer of a flight.

3.4.4.6. Note that, under normal coordination conditions, the function of the operator of the sector where the flight originates is limited to just observing the status of coordination in the flight table. In turn, the operator of the unit that will receive the flight must only accept the coordination in the system. Thus, the workload of operators/coordinators is significantly reduced, together with any errors due to misinterpretation, lapse of memory or neglect.

3.5. **Flow chart**

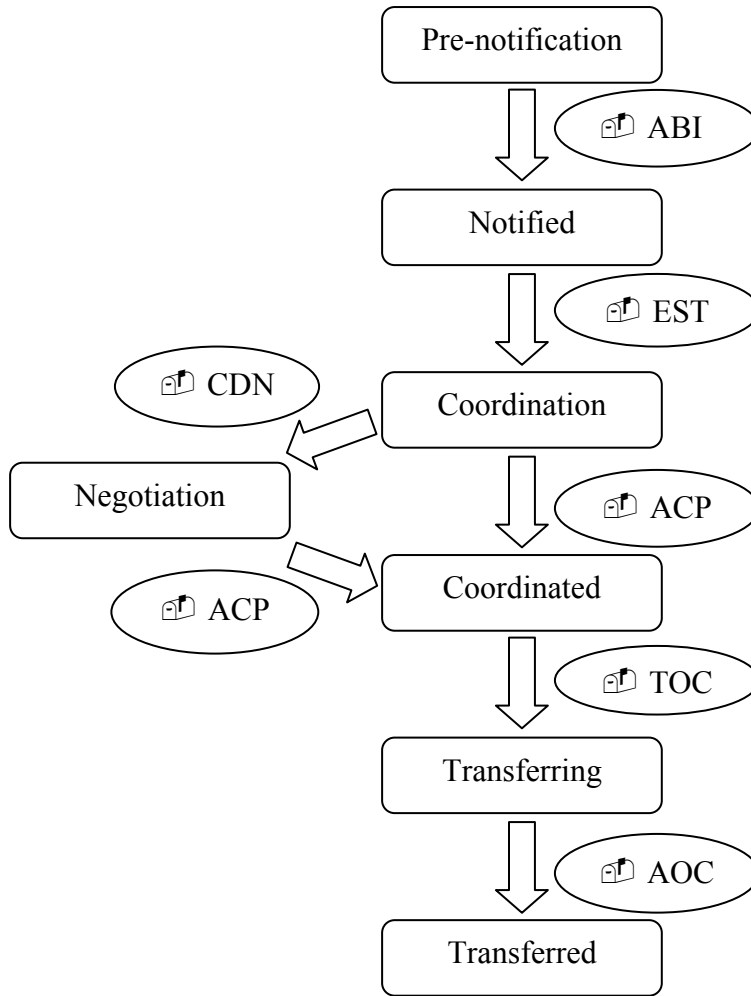

3.6. **Implementation testing phases**

3.6.1. **First phase**

3.6.1.1. ATC automated systems must be configured in such a way that they can mimic as best as possible the times and distances contemplated by controllers for starting coordination with adjacent control units.

3.6.1.2. Whoever adapts and configures the system must know which will be the mailboxes to be used for testing (its own and those of the counterpart).

3.6.1.3. It should be noted that tests would take place between simulators and all AFTN/AMHS addresses of those control units that will not be affected by the tests must be blocked. For example, the addresses of aerodromes to which take-off messages are normally sent automatically must be removed from the databases.

### 3.6.2. **Second phase**

3.6.2.1. A test protocol--covering the widest possible range of cases--will be developed to conduct tests between the two control units, with the participation of technical, database management, and operational personnel. An example of test protocol is presented as **Appendix C**.

3.6.2.2. Tests will involve generating FPLs in both control units and verifying that the systems automatically transmit the notification and coordination messages in accordance with the times and distances established in the configuration.

3.6.2.3. It is recommended that the AIDC or TEST designator be used as the aircraft ID (box 07), followed by a test sequence number.

3.6.2.4. The test will also involve verifying the proper operation of acceptance, rejection, and transfer messages, and an analysis of the reasons why the system may be sending or receiving LRM messages.

### 3.6.3. **Third phase**

3.6.3.1. Once the previous phase has been successfully completed and the correct exchange of messages between the systems has been verified, operational tests will be conducted with the participation of supervisors, instructors, and controllers of each control unit.

3.6.3.2. To complete this stage, consideration should be given to training of operational personnel on the use of AIDC and its benefits.

### 3.6.4. **Fourth phase**

3.6.4.1. Once AIDC coordination procedures have been tested and accepted by the operational personnel, the new letters of agreement will be signed between the control units, incorporating AIDC as an alternate means of coordination initially, and subsequently as the main means of coordination.

## APPENDIX A

### COMMUNICATIONS AND SUPPORT MECHANISMS

#### 1 Introduction

1.1 Coordination communication requirements are divided into two groups, based on voice and data communication requirements between ATS units. As stated throughout the document, and as an objective goal, it is anticipated that the continuing implementation of automated data communications between ATSUs will result in a reduction in the use of voice communications, with the corresponding increase of data communications.

1.1 It has also been clearly stated that AIDC messages could be exchanged on any of the platforms implemented in the Region, whether AMHS and/or AFTN. AIDC messages can also be exchanged through dedicated lines.

1.2 A description follows of AIDC communication considerations concerning header, AFTN priority, optional data field (ODF), addressing, message identification number, reference information, time stamp, CRC, response time, interpretation of AIDC header, and performance measurement.

#### 2 AIDC communication considerations

##### Message header

2.1 The AFTN IA-5 message header includes the use of an **optional data field (ODF)**, which is used for the exchange of all AIDC messages. The AFTN message header (known in this document as AIDC message header) is defined in Annex 10, Vol. II. When using AMHS or a dedicated line, the ODF in the AFTN IA-5 message header still needs to be included as the first line of text in the message. The message header, following the IA-5 standard, which includes an ODF, must be used in both AMHS / AFTN.

2.2 Annex 10, Volume II makes reference to this. In this regard, an extract follows:

*“4.4.4.4.1 Recommendation. – When additional addressing information in a message needs to be exchanged between source and destination addresses, it should be conveyed in the optional data field (ODF), using the following specific format:*

*2.2.1.1. characters one and full stop (1.) to indicate the parameter code for the additional address function;*

*2.2.1.2. three modifier characters, followed by an equal sign [=] and the assigned 8-character ICAO address; and*

*2.2.1.3. the character hyphen (-) to terminate the additional address parameter field.*

*4.4.4.4.1.1 Recommendation. – When a separate address for service messages or inquiries is different from the originator indicator, the modifier SVC should be used.*

*4.4.4.5 The origin line shall be concluded by an alignment function [ $\leq$ ].*

*4.4.15.2.2.6.1 Recommendation. – When additional addressing information in a message needs to be exchanged between source and destination addresses, it should be conveyed in the optional data field (ODF), using the following specific format:*

- a) characters 1 and full stop (1.) to indicate the parameter code for the additional address function;
- b) three modifier characters, followed by an equal sign (=) and the assigned 8-character ICAO address; and
- c) the character hyphen (-) to terminate the additional address parameter field.

**AFTN priority**

2.3 Normally, the priority indicator FF in AFTN/AMHS messages must be used for all AIDC messages, except for EMG, which must be assigned a priority indicator SS.

2.4 Annex 10, Vol. II, states:

“4.4.1.2 Order of priority

4.4.1.2.1 The order of priority for the transmission of messages in the aeronautical fixed telecommunication network shall be as follows:

<i>Transmission priority</i>	<i>Priority indicator</i>
1	SS
2	DD FF
3	GG KK

4.4.1.2.2 Recommendation. – Messages having the same priority indicator should be transmitted in the order in which they are received for transmission.”

flight safety messages  
(see 4.4.1.1.3)

Priority indicator

*Message category*

distress messages (see 4.4.1.1.1) .....	SS
urgency messages (see 4.4.1.1.2) .....	DD
flight safety messages (see 4.4.1.1.3) .....	FF
meteorological messages (see 4.4.1.1.4) .....	GG
flight regularity messages (see 4.4.1.1.5) .....	GG
aeronautical information services messages (see 4.4.1.1.6) .....	GG
aeronautical administrative messages (see 4.4.1.1.7) .....	KK
service messages (see 4.4.1.1.9) .....	(as appropriate)

4.4.1.1.3 Flight safety messages (priority indicator FF) shall comprise:

- a) movement and control messages, as defined in PANS-ATM (Doc 4444), Chapter 11;

- b) messages originated by an aircraft operating agency of immediate concern to aircraft in flight or preparing to depart;
- c) meteorological messages restricted to SIGMET information, special air-reports, AIRMET messages, volcanic ash and tropical cyclone advisory information, and amended forecasts.

2.5 From Doc 4444, Air Traffic Management

*11.1.3 Movement and control messages*

*This message category comprises:*

- a) movement messages (FF), including:
  - filed flight plan messages
  - delay messages
  - modification messages
  - flight plan cancellation messages
  - departure messages
  - arrival messages;
- b) coordination messages (FF), including:
  - current flight plan messages
  - estimate messages
  - coordination messages
  - acceptance messages
  - logical acknowledgment messages;
- c) supplementary messages (FF), including:
  - request flight plan messages
  - request supplementary flight plan messages
  - supplementary flight plan messages;
- d) AIDC messages, including:
  - notification messages
  - coordination messages
  - transfer of control messages
  - general information messages
  - application management messages;
- e) control messages (FF), including:
  - clearance messages
  - flow control messages
  - position-report and air-report messages.

### 11.1.4 Flight information messages

11.1.4.1 This category comprises:

- a) messages containing traffic information (FF);
- b) messages containing meteorological information (FF or GG);
- c) messages concerning the operation of aeronautical facilities (GG);
- d) messages containing essential aerodrome information (GG);
- e) messages concerning air traffic incident reports (FF).

#### Optional data field (ODF)

2.6 ODF provides a flexible way to transmit and respond to AIDC messages, undisturbed by the communication processes along the path of the network.

2.7 ODF 1 has already been allocated for additional addressing use, and is described in Annex 10, Volume II. ODFs 2 and 3 have been defined for computer applications to convey message identification and reference information.

2.8 Use of the ODF is required to ensure success in the exchange of AIDC messages. When AMHS or AFTN/AMHS gateways are used for the exchange of AIDC messages, the specified ODFs must be compatible.

2.9 The proposed encoding would have no impact on AFTN switching centres, as they ignore this part of the origin line.

#### Addressing

2.10 The source and destination addresses of the AFTN header convey the direction and logical identity of the application processes exchanging AIDC information. The application process must be aware of the AFTN addresses that are used for this function.

2.11 The first four characters in the address form the location, in accordance with the location indicators specified in ICAO documentation (Doc 7910), while the next three characters specify an office/agency or a processor at the given location, in accordance with Doc 8585. The eighth character of the address indicates the end system application and is determined by the corresponding AIP.

```
12:28:09 -----  
BSA1675 22122808  
FF SCDA AIDC  
221227 SACCCADI 2.000001-4.160322122737-5.C4D5-  
(ABI-SACO105/A2504-SACO-KONRI/1441F340-SPJC-8/IS-9/A320/M-10/SWYDE1E2  
FGHIR/E-15/N0447F320 DCT ALGAR KONRI LOA)
```

**Example from tests conducted between the Córdoba ACC (Argentina) and the Iquique ACC (Chile) in April 2016**

### Message identification number

2.11 The message identification number is a 6-digit number that is encoded in the AIDC message header ODF 2.

2.13 Each AIDC message will be assigned a message identification number. In this regard, each ATSU must check the message identification numbers to ensure they are not duplicated.

2.14 Consequently, message identification numbers must be sequential. Reception of a message that does not follow the sequence should trigger a warning to the originator.

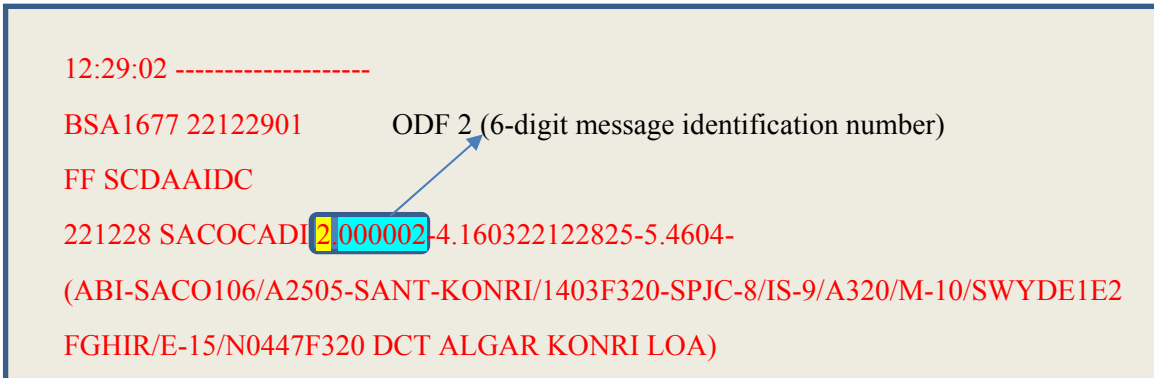

```
12:29:02 -----  
BSA1677 22122901      ODF 2 (6-digit message identification number)  
FF SCDA AIDC  
221228 SACOCADI 2000002-4.160322122825-5.4604-  
(ABI-SACO106/A2505-SANT-KONRI/1403F320-SPJC-8/IS-9/A320/M-10/SWYDE1E2  
FGHIR/E-15/N0447F320 DCT ALGAR KONRI LOA)
```

**Example from tests conducted between the Córdoba ACC (Argentina) and the Iquique ACC (Chile) in April 2016**

### Reference information

2.15 The message reference number is a way of linking an answer to a previously transmitted or received AIDC message.

2.16 The message reference number has two parts:

- The ICAO location indicator of the immediately preceding message in the exchange. This is required because the referenced AIDC message may have originated from an origin number (that is, different ATS units); and
- The message identification number of the first message in the exchange.

2.17 The message reference number is encoded in the AIDC message header ODF 3

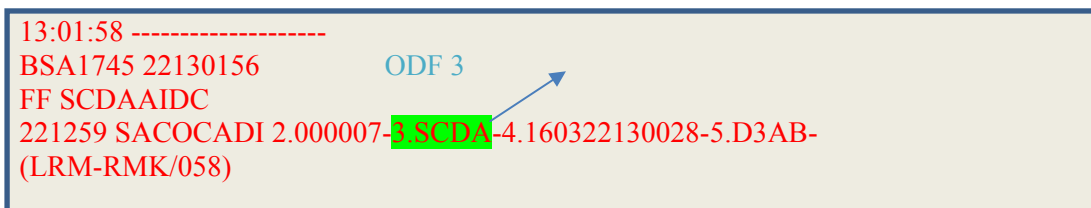

```
13:01:58 -----  
BSA1745 22130156      ODF 3  
FF SCDA AIDC  
221259 SACOCADI 2.000007-3-SCDA-4.160322130028-5.D3AB-  
(LRM-RMK/058)
```

**Example from tests conducted between the Córdoba ACC (Argentina) and the Iquique ACC (Chile) in April 2016**

## Time Stamp

2.18 The time stamp consists of 12 digits that express the year, month, day, hours, minutes, and seconds (YYMMDDHHMMSS) and represents the moment at which the AIDC message is released from the ATS system. The resolution of the Time Stamp in seconds will support computation of transmission delays.

2.19 The Time Stamp is encoded in the AIDC message header ODF 4.

05:08:48 ----- ODF 4 – Time Stamp corresponds to YY:2016  
SBA0151 220508 MM: March; DD: 22 HHMMSS: 05:08:45  
FF SACOCADI  
220508 SCDA AIDC 2.001448-4 160322050845 5.5D0B-  
(ABI-ARG1365/A5635-SPJC-KONRI/0558F350-SAEZ-8/IS-9/B738/M-  
10/SWDFGHIRZ/S-15/N0455F370 DCT PANED UL550 KONRI UL550 ALGAR  
UL550 ROS UA558 MULTA UW24 SNT SNT6A-18/PBN/B2B3D2D3O2O3S1S2  
NAV/B4B5O4D4 DOF/1  
05:08:56 -----  
60322 REG/LVFRK EET/SCFZ0106 SACF0202 SAEF0314 SEL/BRGQ)

## Cyclic redundancy check (CRC)

2.20 The CRC is a 4-digit hexadecimal number that is used to ensure end-to-end message integrity. The method used is the CRC-CCITT (XModem). The CRC is computed over the message text, from the beginning left parenthesis to the closing right parenthesis, both inclusive. Non-printable characters such as line feeds and carriage returns must be excluded from the CRC calculation.

2.21 The CRC is encoded in the AIDC message header ODF 5.

2.22 The CCITT (International Telegraph and Telephone Consultative Committee) has different methods available for CRC calculation. It is important to ensure that the XModem method is used. When AIDC messages are exchanged among different ATS units, the use of a different CRC can create interoperability problems. In order to assist in AIDC system testing, the table below contains a series of AIDC messages and their associated CRCs.

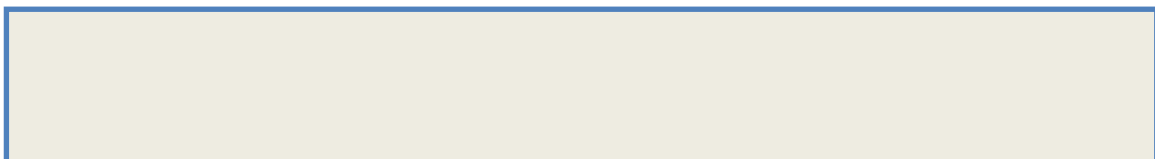

FF SACOCADI

**ODF 5 – CRC: 5D0B**

220508 SCDAIDC 2.001448-4.160322050845-5.5D0B-

(ABI-ARG1365/A5635-SPJC-KONRI/0558F350-SAEZ-8/IS-9/B738/M-10/SWDFGHIRZ/S-15/N0455F370 DCT PANED UL550 KONRI UL550 ALGAR UL550 ROS UA558 MULTA UW24 SNT SNT6A-18/PBN/B2B3D2D3O2O3S1S2 NAV/B4B5O4D4 DOF/160322 REG/LVFRK EET/SCFZ0106 SACF0202 SAEF0314 SEL/BRGQ)

AIDC message	CRC
(ABI-ARG1365/A5635-SPJC-KONRI/0558F350-SAEZ-8/IS-9/B738/M-10/SWDFGHIRZ/S-15/N0455F370 DCT PANED UL550 KONRI UL550 ALGAR UL550 ROS UA558 MULTA UW24 SNT SNT6A-18/PBN/B2B3D2D3O2O3S1S2 NAV/B4B5O4D4 DOF/160322 REG/LVFRK EET/SCFZ0106 SACF0202 SAEF0314 SEL/BRGQ)	5D0B
FF SCDAIDC 221552 SACOCADI 2.000029-4.160322155215-5.630F- (CDN-SACO02/A2514-SANT-SPJC-14/KONRI/1613F360)	630F
FF SACOCADI 221148 SCDAIDC 2.001459-4.160322114808-5.BF76- (MAC-AMX028-MMMX-SAEZ-14/KONRI/1149F390)	BF76
FF SCDAIDC 221544 SACOCADI 2.000028-3.SCDA001486-4.160322154418-5.CF71- (LAM)	CF71
FF SCDAIDC 221543 SACOCADI 2.000027-4.160322154307-5.6D32- (CPL-SACO02/A2514-IS-B738/M-SWDE1E2E3GHRVI/H-SANT-KONRI/1613F340-N0460F340 DCT ALGAR KONRI LOA-SPJC-0)	6D32

**Message confirmation response time**

2.23 The message confirmation response time determines the maximum period of time for a responding application to confirm receipt of a given message. The default value for this timer nominally should be three minutes. If there is no valid answer from the application, the initiating processor must retransmit the message and reset the timer, or initiate local recovery procedures. When local procedures allow retransmission, a maximum value, such as three, must be determined before local recovery procedures are initiated. The response time must be cancelled upon reception of any message with the corresponding message/data reference

identifier, which will typically be a LAM or LRM. Retransmissions use the same message identification number as the original message.

### Interpretation of the AIDC header

2.24 The content of the following AIDC message header is shown, in parts, in the following table:

221505 SACOCADI 2.000024-3.SCDA001482-4.160322150532-5.1416-

Optional Data Field	Use	Example
1	AFTN address	SACOCADI
2	Message identification number	000024
3	Message reference number	SCDA001482
4	Time stamp	160322150532
5	CRC	1416

Note. The script following the CRC (ODF 5) is required to separate the AIDC message header from the AIDC message text.

2.25 The following examples show two AIDC messages encoded according to the previous procedures.

2.26 The first message is the AIDC CDN number (message identification number 001489) sent by the Iquique ACC (Chile) (SCDAAIDC) to the Córdoba AIRCOM ACC (Argentina) (SACOCADI) at 160322160600:

```
16:06:05 -----  
SBA0643 221606  
FF SACOCADI  
221606 SCDAAIDC 2.001489-4.160322160600-5.EFB8-  
(CDN-SACO02/A2514-SANT-SPJC-14/KONRI/1613F380-15/N0460F340 DCT TIKPI  
UL550 ALDAX UL550 EVLEP UL550 SCO)
```

2.27 The following AIDC ACP message shows the response of Córdoba to the CDN message of the previous example.

2.28 Córdoba AIRCOM ACC (Argentina) (SACOCADI) accepts the coordination proposal received from the Iquique ACC (Chile) (SCDAAIDC) by sending an ACP message with message identification number 000032 SACOCADI to SCDAAIDC at 160322160647. The message makes reference to the message previously transmitted by SCDAAIDC, with message reference number SCDA001489. This reference number is a combination of the location indicator (SCDA) and the message identification (001489) of the original message.

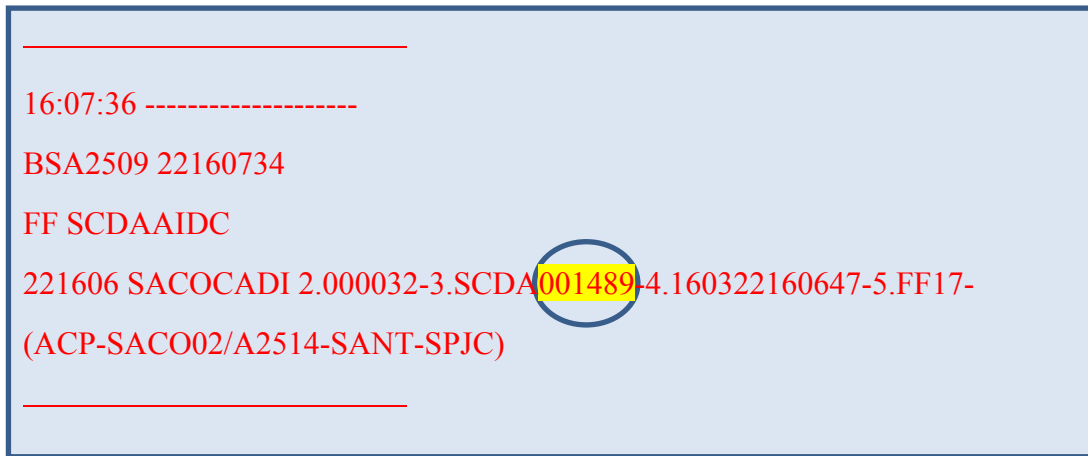

16:07:36 -----  
BSA2509 22160734  
FF SCDAAIDC  
221606 SACOCADI 2.000032-3.SCDA001489-4.160322160647-5.FF17-  
(ACP-SACO02/A2514-SANT-SPJC)

### Engineering considerations

2.29 Traditionally, AIDC messages have been exchanged through the AFTN. However, use of AMHS over TCP/IP platforms is currently proliferating, to which end AMHS/AFTN gateways are used for interconnecting these worlds when so required.

### Performance criteria

2.30 In order to use the AIDC application effectively for the exchange of ATC coordination data, the ATSUs must monitor the performance of communication links to make sure that the required performance is achieved. This monitoring must measure AIDC message traffic latency between ATS systems in terms of measured time, from the transmission of the message at the originating ATS system to message reception at the destination ATS system.

2.31 The performance of communication links must be such that 95% of all messages must be received within 12 seconds of transmission, and 99.9% of all messages must be received within 30 seconds of transmission.

2.32 In bilateral agreements, the ATSUs may agree on different performance requirements, according to the operation between adjacent users.

2.33 The speed of the communication signal between ATS systems using AFTN / AMHS must exceed 2400 bps.

**AIDC performance measurement**

2.34 Monitoring of AIDC performance ensures detection of delays in AFTN or AMHS, as well as the identification of AIDC interoperability issues between adjacent ATS units. As described below, there are different methods that can be used for measuring AIDC performance.

**Performance of a transmitted AIDC message**

2.35 The difference between the time stamp in the header of the transmitted message and the time stamp in the header of the application response message (LAM / LRM) is calculated:

*Example:*

ATSU	Message	Time stamp	Transit time
ATSU 1 Iquique	<hr/> 13:57:08 ----- SBA0536 221357 FF SACOCADI 221357 SCDA AIDC 2.001475- 4.160322135705-5.6970- (TOC-DA01/A5136-SCDA-SABE)	<b>160322135705</b> Year:2016 Month: March Day: 22 Hour:13 Min: 57 <b>Sec: 05</b>	
ATSU 2 Córdoba	<hr/> 13:57:50 ----- BSA2143 22135748 FF SCDA AIDC 221357 SACOCADI 2.000017- 3.SCDA001475-4.160322135717-5.61F8- (LRM-RMK/57)	<b>160322135717</b> Year:2016 Month: March Day: 22 Hour:13 Min: 57 <b>Sec: 17</b>	<b>12 sec</b> TT= (17-05) =12 sec

**Performance of a received AIDC message**

2.36 The difference between the time stamp in the header of the received message and the time stamp in the header of the application response (LAM / LRM) is calculated. Example:

ATSU	Message	Time stamp	Transit time
------	---------	------------	--------------

ATSU 2 Córdoba	_____ 12:28:09 ----- BSA1675 22122808 FF SCDAIDC 221227 SACOCADI 2.000001- 4.160322122737-5.C4D5- (ABI-SACO105/A2504-SACO- KONRI/1441F340-SPJC-8/IS-9/A320/M- 10/SWYDE1E2FGHIR/E-15/N0447F320 DCT ALGAR KONRI LOA) _____	160322122737	
ATSU 1 Iquique	_____ 12:28:14 ----- SBA0456 221228 FF SACOCADI 221228 SCDAIDC 2.001460- 3.SACO000001-4.160322122810-5.E2E8- (LRM-RMK/41/15/DCT ALGAR KONRI LOA) _____	160322122810	<b>33 seconds</b>

Note. Instead of using the time stamp in the header of the application response message, an alternative method is to use the network time stamp of reception of an ABI message sent by ATSU 2.

**Round trip performance in the exchange of AIDC messages**

2.37 Round trip performance can be calculated as follows:

- Comparing the time stamps in the message headers with the time stamps of the network for the first and last messages in the AIDC exchange.

2.38 An alternative method using information derived exclusively from the AIDC message is described below.

Calculation of the difference between the time stamp in the header of the first AIDC message in the exchange and the time stamp in the header of the application response message (LAM / LRM) that is sent when the operational response to the first message is received:

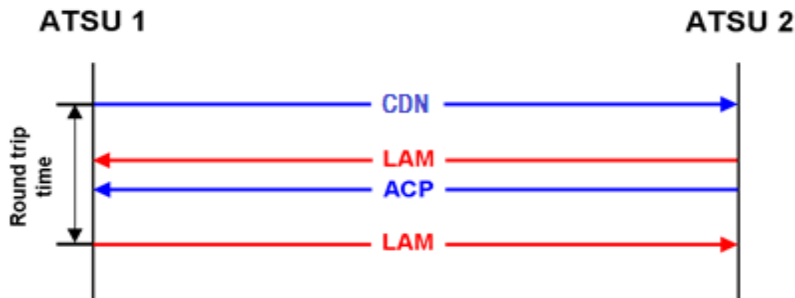

Example:

ATSU	Message	Time stamp	Transit time
ATSU 1 Córdoba	<hr/> 15:52:47 ----- BSA2468 22155246 FF SCDAIDC 221552 SACOCADI 2.000029-4.160322155215- 5.630F- (CDN-SACO02/A2514-SANT-SPJC- 14/KONRI/1613F360)	160322155215	
ATSU 2 Iquique	<hr/> 15:52:53 ----- SBA0631 221552 FF SACOCADI 221552 SCDAIDC 2.001487-3.SACO000029- 4.160322155249-5.CF71- (LAM)	160322155249	
ATSU 2 Iquique	15:53:12 ----- SBA0632 221553 FF SACOCADI 221553 SCDAIDC 2.001488-3.SACO000029- 4.160322155309-5.FF17- (ACP-SACO02/A2514-SANT-SPJC) <hr/>	160322155309	54 sec
ATSU 1 Córdoba	<hr/> 15:54:00 ----- BSA2470 22155359 FF SCDAIDC 221553 SACOCADI 2.000030-3.SCDA001488- 4.160322155337-5.CF71- (LAM)	160322155337	28 sec 1 min 22 sec (round trip)

2.39 Other parameters to be taken into account in the analysis may include the percentage of success in EST/ACP, CDN/ACP and CPL/ACP dialogues, the percentage of successful AOC/TOC exchanges, and the delay of negotiations between CPL and CDN.

2.40 A continuous analysis of LRMs received is also recommended in order to identify AIDC interoperability issues between adjacent ATS units.

**Recording of AIDC data**

2.41 The content and time stamps of all AIDC messages must be recorded in both end systems, in accordance with the current requirements for ATS messages.

2.42 Facilities must be available for the retrieval and display of the recorded data.

### **Testing considerations**

2.43 An alternative to monitoring and analysing the exchange of AIDC messages is to conduct the required tests in non-operational ATS systems.

2.44 When required to use the operational system to conduct AIDC testing, the AIDC message text should have the same format as operational messages, but be distinguishable from operational traffic by the use of non-operational identifiers. However, these identifiers or way of exchanging test traffic must be coordinated and specified in bilateral agreements.

### **Failures and scheduled maintenance**

2.45 ANSPs must be aware that maintenance on AIDC and AFTN/AMHS systems may have an operational effect on these and other applications. An example could be the updating of AIRCOM systems, which may require verification of versions and their respective compatibilities, since this would directly affect the use of AIDC. Another example is the loss of AIDC message functionality due to flooding of messages or out of sequence messages following an AIDC server reboot. Any maintenance affecting AIDC and AFTN/AMHS systems must be previously coordinated with ANSP counterparts, and backup procedures applied to safeguard traffic.

2.46 In case of failure of AIDC support systems, ANSPs must immediately inform counterparts and apply procedures to recover their operational capacity, make backup copies, and restore services as soon as possible.

## APPENDIX B

### IPv4 ADDRESSING

In order to define the SAM IPv4 addressing plan, the following addresses shall be used for each State:

Región	Nro	Estado / Territorio	Red	Direcciones utilizables	Notacion Decimal	Notacion Binaria					
						Región	Estado / Territorio	Host's			
SAM	1	Argentina	10.0.0.0 /19	Primera	10 . 0 . 0 . 1	0 0 0 0 1 0 1 0 . 0 0 0 0 0 0 0 0 0 0	0 0 0 0 0 0 0 0	0 0 0 0 0 0 0 0	0 0 0 0 0 0 0 0 0 0 0 0 0 0 0 1		
				-	-	-	-	-	-	-	-
				Ultima	10 . 0 . 31 . 254	0 0 0 0 1 0 1 0 . 0 0 0 0 0 0 0 0 0 0	0 0 0 0 0 0 0 0	0 0 0 0 0 0 0 0	1 1 1 1 1 1 . 1 1 1 1 1 1 1 1 0		
	2	Chile	10.0.32.0 /19	Primera	10 . 0 . 32 . 1	0 0 0 0 1 0 1 0 . 0 0 0 0 0 0 0 0 0 0	0 0 0 0 0 0 0 0	0 0 0 0 0 0 0 1	0 0 0 0 0 0 . 0 0 0 0 0 0 0 0 0 1		
				-	-	-	-	-	-	-	
				Ultima	10 . 0 . 63 . 254	0 0 0 0 1 0 1 0 . 0 0 0 0 0 0 0 0 0 0	0 0 0 0 0 0 0 0	0 0 0 0 0 0 0 1	1 1 1 1 1 1 . 1 1 1 1 1 1 1 1 0		
	3	Brasil	10.0.64.0 /19	Primera	10 . 0 . 64 . 1	0 0 0 0 1 0 1 0 . 0 0 0 0 0 0 0 0 0 0	0 0 0 0 0 0 0 0	0 0 0 0 0 0 0 1 0	0 0 0 0 0 0 . 0 0 0 0 0 0 0 0 0 1		
				-	-	-	-	-	-	-	
				Ultima	10 . 0 . 95 . 254	0 0 0 0 1 0 1 0 . 0 0 0 0 0 0 0 0 0 0	0 0 0 0 0 0 0 0	0 0 0 0 0 0 0 1 0	1 1 1 1 1 1 . 1 1 1 1 1 1 1 1 0		
	4	Uruguay	10.0.96.0 /19	Primera	10 . 0 . 96 . 1	0 0 0 0 1 0 1 0 . 0 0 0 0 0 0 0 0 0 0	0 0 0 0 0 0 0 0	0 0 0 0 0 0 0 1 1	0 0 0 0 0 0 . 0 0 0 0 0 0 0 0 0 1		
				-	-	-	-	-	-	-	
Ultima				10 . 0 . 127 . 254	0 0 0 0 1 0 1 0 . 0 0 0 0 0 0 0 0 0 0	0 0 0 0 0 0 0 0	0 0 0 0 0 0 0 1 1	1 1 1 1 1 1 . 1 1 1 1 1 1 1 1 0			
5	Paraguay	10.0.128.0 /19	Primera	10 . 0 . 128 . 1	0 0 0 0 1 0 1 0 . 0 0 0 0 0 0 0 0 0 0	0 0 0 0 0 0 0 0	0 0 0 0 0 0 0 1 0 0	0 0 0 0 0 0 . 0 0 0 0 0 0 0 0 0 1			
			-	-	-	-	-	-	-		
			Ultima	10 . 0 . 159 . 254	0 0 0 0 1 0 1 0 . 0 0 0 0 0 0 0 0 0 0	0 0 0 0 0 0 0 0	0 0 0 0 0 0 0 1 0 0	1 1 1 1 1 1 . 1 1 1 1 1 1 1 1 0			
6	Bolivia	10.0.160.0 /19	Primera	10 . 0 . 160 . 1	0 0 0 0 1 0 1 0 . 0 0 0 0 0 0 0 0 0 0	0 0 0 0 0 0 0 0	0 0 0 0 0 0 0 1 0 1	0 0 0 0 0 0 . 0 0 0 0 0 0 0 0 0 1			
			-	-	-	-	-	-	-		
			Ultima	10 . 0 . 191 . 254	0 0 0 0 1 0 1 0 . 0 0 0 0 0 0 0 0 0 0	0 0 0 0 0 0 0 0	0 0 0 0 0 0 0 1 0 1	1 1 1 1 1 1 . 1 1 1 1 1 1 1 1 0			
7	Peru	10.0.192.0 /19	Primera	10 . 0 . 192 . 1	0 0 0 0 1 0 1 0 . 0 0 0 0 0 0 0 0 0 0	0 0 0 0 0 0 0 0	0 0 0 0 0 0 0 1 1 0	0 0 0 0 0 0 . 0 0 0 0 0 0 0 0 0 1			
			-	-	-	-	-	-	-		
			Ultima	10 . 0 . 223 . 254	0 0 0 0 1 0 1 0 . 0 0 0 0 0 0 0 0 0 0	0 0 0 0 0 0 0 0	0 0 0 0 0 0 0 1 1 0	1 1 1 1 1 1 . 1 1 1 1 1 1 1 1 0			
8	Ecuador	10.0.224.0 /19	Primera	10 . 0 . 224 . 1	0 0 0 0 1 0 1 0 . 0 0 0 0 0 0 0 0 0 0	0 0 0 0 0 0 0 0	0 0 0 0 0 0 0 1 1 1	0 0 0 0 0 0 . 0 0 0 0 0 0 0 0 0 1			
			-	-	-	-	-	-	-		
			Ultima	10 . 0 . 255 . 254	0 0 0 0 1 0 1 0 . 0 0 0 0 0 0 0 0 0 0	0 0 0 0 0 0 0 0	0 0 0 0 0 0 0 1 1 1	1 1 1 1 1 1 . 1 1 1 1 1 1 1 1 0			
9	Colombia	10.1.0.0 /19	Primera	10 . 1 . 0 . 1	0 0 0 0 1 0 1 0 . 0 0 0 0 0 0 0 0 0 0	0 0 0 0 0 0 0 0	0 0 0 0 1 0 0 0 0	0 0 0 0 0 0 . 0 0 0 0 0 0 0 0 0 1			
			-	-	-	-	-	-	-		
			Ultima	10 . 1 . 31 . 254	0 0 0 0 1 0 1 0 . 0 0 0 0 0 0 0 0 0 0	0 0 0 0 0 0 0 0	0 0 0 0 1 0 0 0 0	1 1 1 1 1 1 . 1 1 1 1 1 1 1 1 0			
10	Venezuela	10.1.32.0 /19	Primera	10 . 1 . 32 . 1	0 0 0 0 1 0 1 0 . 0 0 0 0 0 0 0 0 0 0	0 0 0 0 0 0 0 0	0 0 0 0 1 0 0 0 1	0 0 0 0 0 0 . 0 0 0 0 0 0 0 0 0 1			
			-	-	-	-	-	-	-		
			Ultima	10 . 1 . 63 . 254	0 0 0 0 1 0 1 0 . 0 0 0 0 0 0 0 0 0 0	0 0 0 0 0 0 0 0	0 0 0 0 1 0 0 0 1	1 1 1 1 1 1 . 1 1 1 1 1 1 1 1 0			
11	Guyana	10.1.64.0 /19	Primera	10 . 1 . 64 . 1	0 0 0 0 1 0 1 0 . 0 0 0 0 0 0 0 0 0 0	0 0 0 0 0 0 0 0	0 0 0 0 1 0 0 1 0	0 0 0 0 0 0 . 0 0 0 0 0 0 0 0 0 1			
			-	-	-	-	-	-	-		
			Ultima	10 . 1 . 95 . 254	0 0 0 0 1 0 1 0 . 0 0 0 0 0 0 0 0 0 0	0 0 0 0 0 0 0 0	0 0 0 0 1 0 0 1 0	1 1 1 1 1 1 . 1 1 1 1 1 1 1 1 0			
12	Surinam	10.1.96.0 /19	Primera	10 . 1 . 96 . 1	0 0 0 0 1 0 1 0 . 0 0 0 0 0 0 0 0 0 0	0 0 0 0 0 0 0 0	0 0 0 0 1 0 0 1 1	0 0 0 0 0 0 . 0 0 0 0 0 0 0 0 0 1			
			-	-	-	-	-	-	-		
			Ultima	10 . 1 . 127 . 254	0 0 0 0 1 0 1 0 . 0 0 0 0 0 0 0 0 0 0	0 0 0 0 0 0 0 0	0 0 0 0 1 0 0 1 1	1 1 1 1 1 1 . 1 1 1 1 1 1 1 1 0			
13	Guyana Francesa (France)	10.1.128.0 /19	Primera	10 . 1 . 128 . 1	0 0 0 0 1 0 1 0 . 0 0 0 0 0 0 0 0 0 0	0 0 0 0 0 0 0 0	0 0 0 0 1 0 0 1 0 0	0 0 0 0 0 0 . 0 0 0 0 0 0 0 0 0 1			
			-	-	-	-	-	-	-		
			Ultima	10 . 1 . 159 . 254	0 0 0 0 1 0 1 0 . 0 0 0 0 0 0 0 0 0 0	0 0 0 0 0 0 0 0	0 0 0 0 1 0 0 1 0 0	1 1 1 1 1 1 . 1 1 1 1 1 1 1 1 0			

## APPENDIX C

### MODEL PROCEDURES FOR CONDUCTING AIDC EXCHANGE TESTS

Protocol for testing AIDC operation and functionality between ACC "A" and ACC "B"

#### 1. Coordination using the EST message

##### 1.1. SYSTEM CONFIGURATION

ABI SEND TIME (min):	60
ETO DELTA (min):	3
FL DELTA (hFt):	10
EST/CPL MSG (min):	30
EST/CPL MSG (Nm):	60
LAM TIME (min):	2
ACP TIME (min):	5
RENEGOTIATION TIME (min):	5

AIDC SEND TIME:	Time before arrival to the ABI message delivery coordination fix.
<i>ETO DELTA:</i>	Difference in the estimated time of flight over the coordination fix that triggers the delivery of a new ABI message.
<i>FL DELTA:</i>	Difference in FL at the coordination fix that triggers the delivery of a new ABI message.
EST/CPL MSG min	Time before arrival to the coordination fix that triggers an EST or CPL message.
EST/CPL MSG Nm	Distance to the coordination fix that triggers an EST or CPL message.
	Waiting time of LAM message.
	Waiting time of ACP message.
RENEGOTIATION:	Waiting time time to renegotiate coordination.

**1.2. ABI / EST / LAM / TIME OUT TEST**

ACTION	EXPECTED RESPONSE ACC "A"	EXPECTED RESPONSE ACC "B"
1.2.1. Create and deliver a <b>FPL</b> for a flight leaving an aerodrome in FIR "A", that is <b>more than 30 minutes</b> flight time from take-off to the coordination fix (FIR boundary), whose EOBT is <b>more than 60 minutes</b> from current time.	The ACC "A" system must <b>not</b> deliver any automatic message. Coordination must be in <b>PRE-NOTIFYING</b> status.	
1.2.2. 60 minutes before the time at which the created flight should fly over the coordination fix, review the <b>FPL</b> template history.	The ACC "A" system must send an <b>ABI</b> message and receive a <b>LAM</b> message. Coordination must change to <b>NOTIFYING</b> status.	The ACC "B" system must receive an <b>ABI</b> message and send a <b>LAM</b> message. Coordination must change to <b>NOTIFYING</b> status.
1.2.3. Activate the <b>FPL</b> by inserting a take-off time (current time).	The ACC "A" system must <b>not</b> send any automatic message. Coordination must be in <b>NOTIFYING</b> status and the <b>FPL</b> must change to ACTIVE mode.	Coordination must be in <b>NOTIFYING</b> status.
1.2.4. 30 minutes before the time at which the activated flight must fly over the coordination fix, review the FPL template history.	The ACC "A" system must send an <b>EST</b> message and receive a <b>LAM</b> message. Coordination status must change to <b>COORDINATING</b> .	The ACC "B" system must receive an <b>EST</b> message and send a <b>LAM</b> message. Coordination status must change to <b>COORDINATING</b> and the <b>FPL</b> must change to ACTIVE mode.
1.2.5. DO NOT ACT UPON THE <b>FPL</b> .	Coordination must remain in <b>COORDINATING</b> status and <b>FPL</b> ACTIVE. 5 minutes after sending the <b>EST</b> message, the system will show <b>TIME OUT</b> .	Coordination must remain in <b>COORDINATING</b> status and <b>FPL</b> ACTIVE. 5 minutes after receiving the <b>EST</b> message, the system will show <b>TIME OUT</b> .

Example:

At 12:00 UTC

(FPL-TEST01-IS-B737/M-SW/C-SAEZ1330-N0450F320 ATOVO UW5 ROS UL550 LIM-SPIM0430-0)

*Note: This test will not be conducted on automatic ACP response systems.*

**1.3. ABI / EST / LAM / ACP / TOC / AOC TEST**

ACTION	EXPECTED RESPONSE ACC "A"	EXPECTED RESPONSE ACC "B"
1.3.1. Create and send an <b>FPL</b> for a flight leaving from an aerodrome in FIR "A" that is <b>more than 30 minutes</b> flight time from take-off to the coordination fix (FIR boundary), whose EOBT is <b>more than 60 minutes</b> from current time.	The ACC "A" system must <b>not</b> send any automatic message. Coordination must be in <b>PRE-NOTIFYING</b> status.	
1.3.2. 60 minutes before the time at which the flight should fly over the coordination fix, review the FPL template history.	The ACC "A" system must send an <b>ABI</b> message and receive a <b>LAM</b> message. Coordination status must change to <b>NOTIFYING</b> .	The ACC "B" system must receive an <b>ABI</b> message and send a <b>LAM</b> message. Coordination status must change to <b>NOTIFYING</b> .
1.3.3. Activate the <b>FPL</b> by inserting a take-off time (current time).	The ACC "A" system must <b>not</b> send any automatic message. Coordination must be in <b>NOTIFYING</b> status and the <b>FPL</b> must change to ACTIVE.	Coordination must be in <b>NOTIFYING</b> status.
1.3.4. 30 minutes before the time at which the activated flight must fly over the coordination fix, review the FPL template history.	The ACC "A" system must send an <b>EST</b> message and receive a <b>LAM</b> message. Coordination status must change to <b>COORDINATING</b> .	The ACC "B" system must receive an <b>EST</b> message and send a <b>LAM</b> message. Coordination status must change to <b>COORDINATING</b> and the <b>FPL</b> must change to ACTIVE.
1.3.5. From the ACC "B" system, send an <b>ACP</b> message. Delivery can be manual or automatic.	The ACC "A" system must receive an <b>ACP</b> message and send a <b>LAM</b> message. Coordination status must change to <b>COORDINATED</b> .	The ACC "B" system must send an <b>ACP</b> message and receive a <b>LAM</b> message. Coordination status must change to <b>COORDINATED</b> .
1.3.6. From the ACC "A" system, send a <b>TOC</b> message.	The ACC "A" system must send a <b>TOC</b> message and receive a <b>LAM</b> message. Coordination status must change to <b>TRANSFERRING</b> .	The ACC "B" system must receive a <b>TOC</b> message and send a <b>LAM</b> message. Coordination status must change to <b>TRANSFERRING</b> .
1.3.7. From the ACC "B" system, send an <b>AOC</b> message.	The ACC "A" system must receive an <b>AOC</b> message and send a <b>LAM</b> message. Coordination status must change to <b>TRANSFERRED</b> .	The ACC "B" system must send an <b>AOC</b> message and receive a <b>LAM</b> message. Coordination status must change to <b>TRANSFERRED</b> .

Example:

At 12:00 UTC

(FPL-TEST02-IS-B737/M-SW/C-SAEZ1330-N0450F320 ATOVO UW5 ROS UL550 LIM-SPIM0430-0)

**1.4. ABI / EST / LAM / ACP / TOC / AOC TEST**

ACTION	EXPECTED RESPONSE ACC "A"	EXPECTED RESPONSE ACC "B"
1.4.1. Create and send an <b>FPL</b> for a flight leaving from an aerodrome in FIR "A" that is <b>more than 30 minutes</b> flight time from take-off to the coordination fix (FIR boundary), whose EOBT is <b>less than 60 minutes</b> from the current time.	The ACC "A" system must send an <b>ABI</b> message and receive a <b>LAM</b> message. Coordination status must change to <b>NOTIFYING</b> .	The ACC "B" system must receive an <b>ABI</b> message and send a <b>LAM</b> message. Coordination status must change to <b>NOTIFYING</b> .
1.4.2. Activate the <b>FPL</b> by inserting the take-off time (current time).	The ACC "A" system must <b>not</b> send any automatic message. Coordination must be in <b>NOTIFYING</b> status and the <b>FPL</b> must change to ACTIVE mode.	Coordination must be in <b>NOTIFYING</b> status.
1.4.3. 30 minutes before the time at which the activated flight must fly over the coordination fix, review the FPL template history.	The ACC "A" system must send an <b>EST</b> message and receive a <b>LAM</b> message. Coordination status must change to <b>COORDINATING</b> .	The ACC "B" system must receive an <b>EST</b> message and send a <b>LAM</b> message. Coordination status must change to <b>COORDINATING</b> and the <b>FPL</b> must change to ACTIVE mode.
1.4.4. From the ACC "B" system, send an <b>ACP</b> message. Delivery can be manual or automatic.	The ACC "A" system must receive an <b>ACP</b> message and send a <b>LAM</b> message. Coordination status must change to <b>COORDINATED</b> .	The ACC "B" system must send an <b>ACP</b> message and receive a <b>LAM</b> message. Coordination status must change to <b>COORDINATED</b> .
1.4.5. From the ACC "A" system, send a <b>TOC</b> message.	The ACC "A" system must send a <b>TOC</b> message and receive a <b>LAM</b> message. Coordination status must change to <b>TRANSFERRING</b> .	The ACC "B" system must receive a <b>TOC</b> message and send a <b>LAM</b> message. Coordination status must change to <b>TRANSFERRING</b> .
1.4.6. From the ACC "B" system, send an <b>AOC</b> message.	The ACC "A" system must receive an <b>AOC</b> message and send a <b>LAM</b> message. Coordination status must change to <b>TRANSFERRED</b> .	The ACC "B" system must send an <b>AOC</b> message and receive a <b>LAM</b> message. Coordination status must change to <b>TRANSFERRED</b> .

Example:

At 12:00 UTC

(FPL-TEST03-IS-B737/M-SW/C-SAEZ1250-N0450F320 ATOVO UW5 ROS UL550 LIM-SPIM0430-0)

**1.5. ABI / PAC / LAM / ACP / TOC / AOC TEST**

ACTION	EXPECTED RESULT ACC "A"	EXPECTED RESULT ACC "B"
<p>1.5.1. Create and send an <b>FPL</b> for a flight leaving from an aerodrome in FIR "A" that is <b>less than 30 minutes</b> flight time from take-off to the coordination fix (FIR boundary), whose EOBT is <b>less than 60 minutes</b> between current time and the time at which this flight should fly over the coordination fix.</p>	<p>The ACC "A" system must send an <b>ABI</b> message and receive a <b>LAM</b> message and send a <b>PAC</b> message and receive a <b>LAM</b> message. Coordination status must change to <b>COORDINATING</b>.</p>	<p>The ACC "B" system must receive an <b>ABI</b> message and send a <b>LAM</b> message and receive a <b>PAC</b> message and send a <b>LAM</b> message. Coordination status must change to <b>COORDINATING</b>.</p>
<p>1.5.2. From the ACC "B" system, send an <b>ACP</b> message.</p>	<p>The ACC "A" system must receive an <b>ACP</b> message and send a <b>LAM</b> message. Coordination status must change to <b>COORDINATED</b>.</p>	<p>The ACC "B" system must send an <b>ACP</b> message and receive a <b>LAM</b> message. Coordination status must change to <b>COORDINATED</b>.</p>
<p>1.5.3. Activate the <b>FPL</b> by inserting a take-off time (current time).</p>	<p>Coordination must remain in the <b>COORDINATED</b> status and the <b>FPL</b> ACTIVE.</p>	<p>Coordination must remain in the <b>COORDINATED</b> status and the <b>FPL</b> must be activated by detection and correlation.</p>
<p>1.5.4. From the ACC "A" system, send a <b>TOC</b> message.</p>	<p>The ACC "A" system must send a <b>TOC</b> message and receive a <b>LAM</b> message. Coordination status must change to <b>TRANSFERRING</b>.</p>	<p>The ACC "B" system must receive a <b>TOC</b> message and send a <b>LAM</b> message. Coordination status must change to <b>TRANSFERRING</b>.</p>
<p>1.5.5. From the ACC "B" message, send an <b>AOC</b> message.</p>	<p>The ACC "A" system must receive an <b>AOC</b> message and send a <b>LAM</b> message. Coordination status must change to <b>TRANSFERRED</b>.</p>	<p>The ACC "B" system must send an <b>AOC</b> message and receive a <b>LAM</b> message. Coordination status must change to <b>TRANSFERRED</b>.</p>

Example:

At 12:00 UTC

(FPL-TEST04-IS-B737/M-SW/C-SAAR1230-N0450F260 ROS UL550 LIM-SPIM0330-0)

**1.6. (Multiple) ABI / EST / LAM / ACP / TOC / AOC TEST**

ACTION	EXPECTED RESPONSE ACC "A"	EXPECTED RESPONSE ACC "B"
1.6.1. Create and send an <b>FPL</b> for a flight leaving from an aerodrome in FIR "A" that is <b>more than 30 minutes</b> flight time from take-off to the coordination fix (FIR boundary), whose EOBT is <b>less than 60 minutes</b> from current time.	The ACC "A" system must send an <b>ABI</b> message and receive a <b>LAM</b> message. Coordination status must change to <b>NOTIFYING</b> .	The ACC "B" system must receive an <b>ABI</b> message and send a <b>LAM</b> message. Coordination status must change to <b>NOTIFYING</b> .
1.6.2. In the <b>FPL</b> template, change the EOBT, FL, ROUTE or DESTINATION.	The ACC "A" system must send an <b>ABI</b> message and receive a <b>LAM</b> message. Coordination must remain in <b>NOTIFYING</b> status.	The ACC "B" system must receive an <b>ABI</b> message and send a <b>LAM</b> message. Coordination must remain in <b>NOTIFYING</b> status. The <b>FPL</b> must be modified in accordance with the change made in the ACC "A" system.
1.6.3. Activate the <b>FPL</b> by inserting a take-off time (current time).	The ACC "A" system must <b>not</b> send any automatic message. Coordination must be in <b>NOTIFYING</b> status and the <b>FPL</b> must change to ACTIVE.	Coordination must be in <b>NOTIFYING</b> status.
1.6.4. 30 minutes before the time at which the activated flight must fly over the coordination fix, review the FPL template history.	The ACC "A" system must send an <b>EST</b> message and receive a <b>LAM</b> message. Coordination status must change to <b>COORDINATING</b> .	The ACC "B" system must receive an <b>EST</b> message and send a <b>LAM</b> message. Coordination status must change to <b>COORDINATING</b> and the <b>FPL</b> must change to ACTIVE.
1.6.5. From the ACC "B" system, send an <b>ACP</b> message. Delivery can be manual or automatic.	The ACC "A" system must receive an <b>ACP</b> message and send a <b>LAM</b> message. Coordination status must change to <b>COORDINATED</b> .	The ACC "B" system must send an <b>ACP</b> message and receive a <b>LAM</b> message. Coordination status must change to <b>COORDINATED</b> .
1.6.6. From the ACC "A" system, send a <b>TOC</b> message.	The ACC "A" system must send a <b>TOC</b> message and receive a <b>LAM</b> message. Coordination status must change to <b>TRANSFERRING</b> .	The ACC "B" system must receive a <b>TOC</b> message and send a <b>LAM</b> message. Coordination status must change to <b>TRANSFERRING</b> .
1.6.7. From the ACC "B" system, send an <b>AOC</b> message.	The ACC "A" system must receive an <b>AOC</b> message and send a <b>LAM</b> message. Coordination status must change to <b>TRANSFERRED</b> .	The ACC "B" system must send an <b>AOC</b> message and receive a <b>LAM</b> message. Coordination status must change to <b>TRANSFERRED</b> .

Example:

At 12:00 UTC

(FPL-TEST05-IS-B737/M-SW/C-SAEZ1250-N0450F320 ATOVO UW5 ROS UL550 LIM-SPIM0430-0)

**1.7. ABI / EST / LAM / ACP / CDN / TOC / AOC TEST**

ACTION	EXPECTED RESPONSE ACC "A"	EXPECTED RESPONSE ACC "B"
<p>1.7.1. Create and send an <b>FPL</b> for a flight leaving from an aerodrome in FIR "A" that is <b>more than 30 minutes</b> flight time from take-off to the coordination fix (FIR boundary), whose EOBT is <b>less than 60 minutes</b> from the current time.</p>	<p>The ACC "A" system must send an <b>ABI</b> message and receive a <b>LAM</b> message. Coordination status must change to <b>NOTIFYING</b>.</p>	<p>The ACC "B" system must receive an <b>ABI</b> message and send a <b>LAM</b> message. Coordination status must change to <b>NOTIFYING</b>.</p>
<p>1.7.2. Activate the <b>FPL</b> by inserting a take-off time (current time).</p>	<p>The ACC "A" system must <b>not</b> send any automatic message. Coordination must be in <b>NOTIFYING</b> status and the <b>FPL</b> must change to ACTIVE mode.</p>	<p>Coordination must be in <b>NOTIFYING</b> status.</p>
<p>1.7.3. 30 minutes before the time at which the activated flight must fly over the coordination fix, review the FPL template history.</p>	<p>The ACC "A" system must send an <b>EST</b> message and receive a <b>LAM</b> message. Coordination status must change to <b>COORDINATING</b>.</p>	<p>The ACC "B" system must receive an <b>EST</b> message and send a <b>LAM</b> message. Coordination status must change to <b>COORDINATING</b> and the <b>FPL</b> must change to ACTIVE mode.</p>
<p>1.7.4. From the ACC "B" system, send an <b>ACP</b> message. Delivery can be manual or automatic.</p>	<p>The ACC "A" system must receive an <b>ACP</b> message and send a <b>LAM</b> message. Coordination status must change to <b>COORDINATED</b>.</p>	<p>The ACC "B" system must send an <b>ACP</b> message and receive a <b>LAM</b> message. Coordination status must change to <b>COORDINATED</b>.</p>
<p>1.7.5. From the ACC "A" system, send a <b>CDN</b> message.</p>	<p>The ACC "A" system must send a <b>CDN</b> message and receive a <b>LAM</b> message. Coordination status must change to <b>RE-NEGOTIATING</b>.</p>	<p>The ACC "B" system must receive a <b>CDN</b> message and send a <b>LAM</b> message. Coordination status must change to <b>RE-NEGOTIATING</b>.</p>
<p>1.7.6. From the ACC "B" system, send an <b>ACP</b> message.</p>	<p>The ACC "A" system must receive an <b>ACP</b> message and send a <b>LAM</b> message. Coordination status must change to <b>COORDINATED</b>.</p>	<p>The ACC "B" system must send an <b>ACP</b> message and receive a <b>LAM</b> message. Coordination status must change to <b>COORDINATED</b>.</p>
<p>1.7.7. From the ACC "A" system, send a <b>TOC</b> message.</p>	<p>The ACC "A" system must send a <b>TOC</b> message and receive a <b>LAM</b> message. Coordination status must change to <b>TRANSFERRING</b>.</p>	<p>The ACC "B" system must receive a <b>TOC</b> message and send a <b>LAM</b> message. Coordination status must change to <b>TRANSFERRING</b>.</p>
<p>1.7.8. From the ACC "B" system, send an <b>AOC</b> message.</p>	<p>The ACC "A" system must receive an <b>AOC</b> message and send a <b>LAM</b> message. Coordination status must change to <b>TRANSFERRED</b>.</p>	<p>The ACC "B" system must send an <b>AOC</b> message and receive a <b>LAM</b> message. Coordination status must change to</p>

		TRANSFERRED.
--	--	--------------

Example:

At 12:00 UTC

(FPL-TEST06-IS-B737/M-SW/C-SAEZ1250-N0450F320 ATOVO UW5 ROS UL550 LIM-SPIM0430-0)

## 2 Coordination using the CPL message

### 2.1 SYSTEM CONFIGURATION

ABI SEND TIME (min):	60
ETO DELTA (min):	3
FL DELTA (hFt):	10
CPL MSG (min):	30
CPL MSG (Nm):	60
LAM TIME (min):	2
ACP TIME (min):	5
RENEGOTIATION TIME (min):	5

**2.2 ABI / CPL / LAM / TIME OUT TEST**

ACTION	EXPECTED RESPONSE ACC "A"	EXPECTED RESPONSE ACC "B"
<p>2.2.1 Create and send an <b>FPL</b> for a flight leaving from an aerodrome in FIR "A" that is <b>more than 30 minutes</b> flight time from take-off to the coordination fix (FIR boundary), whose EOBT is <b>more than 60 minutes</b> from current time.</p>	<p>The ACC "A" system must <b>not</b> send any automatic message. Coordination must be in <b>PRE-NOTIFYING</b> status.</p>	
<p>2.2.2 60 minutes before the time at which the flight should be flying over the coordination fix, review the FPL template history.</p>	<p>The ACC "A" system must send an <b>ABI</b> message and receive a <b>LAM</b> message. Coordination status must change to <b>NOTIFYING</b>.</p>	<p>The ACC "B" system must receive an <b>ABI</b> message and send a <b>LAM</b> message. Coordination status must change to <b>NOTIFYING</b>.</p>
<p>2.2.3 Activate the <b>FPL</b> by inserting the take-off time (current time).</p>	<p>The ACC "A" system must <b>not</b> send any automatic message. Coordination must be in <b>NOTIFYING</b> status and the <b>FPL</b> must change to ACTIVE mode.</p>	<p>Coordination must be in <b>NOTIFYING</b> status.</p>
<p>2.2.4 30 minutes before the time at which the activated flight must fly over the coordination fix, review the FPL template history.</p>	<p>The ACC "A" system must send a <b>CPL</b> message and receive a <b>LAM</b> message. Coordination status must change to <b>NEGOTIATING</b>.</p>	<p>The ACC "B" system must receive a <b>CPL</b> message and send a <b>LAM</b> message. Coordination status must change to <b>NEGOTIATING</b> and the <b>FPL</b> must change to ACTIVE mode.</p>
<p>2.2.5 DO NOT ACT UPON THE <b>FPL</b>.</p>	<p>Coordination must remain in <b>NEGOTIATING</b> status and the <b>FPL</b> ACTIVE. 5 minutes after sending the <b>CPL</b> message, the system will show <b>TIME OUT</b>.</p>	<p>Coordination must remain in <b>NEGOTIATING</b> status and the <b>FPL</b> ACTIVE. 5 minutes after receiving the <b>CPL</b> message, the system will show <b>TIME OUT</b>.</p>

Example:

At 12:00 UTC

(FPL-TEST07-IS-B737/M-SW/C-SAEZ1330-N0450F320 ATOVO UW5 ROS UL550 LIM-SPIM0430-0)

**ABI / CPL / LAM / ACP / TOC / AOC TEST**

ACTION	EXPECTED RESPONSE ACC "A"	EXPECTED RESPONSE ACC "B"
2.2.6 Create and send an <b>FPL</b> for a flight leaving from an aerodrome in FIR "A" that is <b>more than 30 minutes</b> flight time from take-off to the coordination fix (FIR boundary), whose EOBT is <b>more than 60 minutes</b> from current time.	The ACC "A" system must <b>not</b> send any automatic message. Coordination must be in <b>PRE-NOTIFYING</b> status.	
2.2.7 60 minutes before the time at which the created flight should fly over the coordination fix, review the FPL template history.	The ACC "A" system must send an <b>ABI</b> message and receive a <b>LAM</b> message. Coordination status must change to <b>NOTIFYING</b> .	The ACC "B" system must receive an <b>ABI</b> message and send a <b>LAM</b> message. Coordination status must change to <b>NOTIFYING</b> .
2.2.8 Activate the <b>FPL</b> by inserting the take-off time (current time).	The ACC "A" system must <b>not</b> send any automatic message. Coordination must be in <b>NOTIFYING</b> status and the <b>FPL</b> must change to ACTIVE mode.	Coordination must be in <b>NOTIFYING</b> status.
2.2.9 30 minutes before the time at which the activated flight must fly over the coordination fix, review the FPL template history.	The ACC "A" system must send a <b>CPL</b> message and receive a <b>LAM</b> message. Coordination status must change to <b>NEGOTIATING</b> .	The ACC "B" system must receive a <b>CPL</b> message and send a <b>LAM</b> message. Coordination status must change to <b>NEGOTIATING</b> and the <b>FPL</b> must change to ACTIVE mode.
2.2.10 From the ACC "B" system, send an <b>ACP</b> message.	The ACC "A" system must receive an <b>ACP</b> message and send a <b>LAM</b> message. Coordination status must change to <b>COORDINATED</b> .	The ACC "B" system must send an <b>ACP</b> message and receive a <b>LAM</b> message. Coordination status must change to <b>COORDINATED</b> .
2.2.11 From the ACC "A" system, send a <b>TOC</b> message.	The ACC "A" system must send a <b>TOC</b> message and receive a <b>LAM</b> message. Coordination status must change to <b>TRANSFERRING</b> .	The ACC "B" system must receive a <b>TOC</b> message and send a <b>LAM</b> message. Coordination status must change to <b>TRANSFERRING</b> .
2.2.12 From the ACC "B" system, send an <b>AOC</b> message.	The ACC "A" system must receive an <b>AOC</b> message and send a <b>LAM</b> message. Coordination status must change to <b>TRANSFERRED</b> .	The ACC "B" system must send an <b>AOC</b> message and receive a <b>LAM</b> message. Coordination status must change to <b>TRANSFERRED</b> .

Example:

At 12:00 UTC

(FPL-TEST08-IS-B737/M-SW/C-SAEZ1330-N0450F320 ATOVO UW5 ROS UL550 LIM-SPIM0430-0)

### 2.3 ABI / CPL / LAM / ACP / TOC / AOC TEST

ACTION	EXPECTED RESPONSE ACC "A"	EXPECTED RESPONSE ACC "B"
2.3.1 Create and send an <b>FPL</b> for a flight leaving from an aerodrome in FIR "A" that is <b>more than 30 minutes</b> flight time from take-off to the coordination fix (FIR boundary), whose EOBT is <b>less than 60 minutes</b> from current time.	The ACC "A" system must send an <b>ABI</b> message and receive a <b>LAM</b> message. Coordination status must change to <b>NOTIFYING</b> .	The ACC "B" system must receive an <b>ABI</b> message and send a <b>LAM</b> message. Coordination status must change to <b>NOTIFYING</b> .
2.3.2 Activate the <b>FPL</b> by inserting a take-off time (current time).	The ACC "A" system must <b>not</b> send any automatic message. Coordination must be in <b>NOTIFYING</b> status and the <b>FPL</b> must change to ACTIVE mode.	Coordination must be in <b>NOTIFYING</b> status.
2.3.3 30 minutes before the time at which the activated flight must fly over the coordination fix, review the FPL template history.	The ACC "A" system must send a <b>CPL</b> message and receive a <b>LAM</b> message. Coordination status must change to <b>NEGOTIATING</b> .	The ACC "B" system must receive a <b>CPL</b> message and send a <b>LAM</b> message. Coordination status must change to <b>NEGOTIATING</b> and the <b>FPL</b> to ACTIVE mode.
2.3.4 From the ACC "B" system, send an <b>ACP</b> message.	The ACC "A" system must receive an <b>ACP</b> message and send a <b>LAM</b> message. Coordination status must change to <b>COORDINATED</b> .	The ACC "B" system must send an <b>ACP</b> message and receive a <b>LAM</b> message. Coordination status must change to <b>COORDINATED</b> .
2.3.5 From the ACC "A" system, send a <b>TOC</b> message.	The ACC "A" system must send a <b>TOC</b> message and receive a <b>LAM</b> message. Coordination status must change to <b>TRANSFERRING</b> .	The ACC "B" system must receive a <b>TOC</b> message and send a <b>LAM</b> message. Coordination status must change to <b>TRANSFERRING</b> .
2.3.6 From the ACC "B" system, send an <b>AOC</b> message.	The ACC "A" system must receive an <b>AOC</b> message and send a <b>LAM</b> message. Coordination status must change to <b>TRANSFERRED</b> .	The ACC "B" system must send an <b>AOC</b> message and receive a <b>LAM</b> message. Coordination status must change to <b>TRANSFERRED</b> .

Example:

At 12:00 UTC

(FPL-TEST09-IS-B737/M-SW/C-SAEZ1250-N0450F320 ATOVO UW5 ROS UL550 LIM-SPIM0430-0)

2.4 ABI / CPL / LAM / ACP / TOC / AOC TEST

ACTION	EXPECTED RESPONSE ACC "A"	EXPECTED RESPONSE ACC "B"
2.4.1 Create and send an <b>FPL</b> for a flight leaving from an aerodrome in FIR "A" that is <b>less than 30 minutes</b> flight time from take-off to the coordination fix (FIR boundary), whose EOBT is <b>less than 60</b> minutes between current time and the time at which this flight should fly over the coordination fix.	The ACC "A" system must send an <b>ABI</b> message and receive a <b>LAM</b> message. Coordination status must change to <b>COORDINATING</b> .	The ACC "B" system must receive an <b>ABI</b> message and send a <b>LAM</b> message. Coordination status must change to <b>COORDINATING</b> .
2.4.2 Activate the <b>FPL</b> by inserting a take-off time (current time).	The ACC "A" system must send a <b>CPL</b> message and receive a <b>LAM</b> message. Coordination status must change to <b>NEGOTIATING</b> .	The ACC "B" system must RECEIVE a <b>CPL</b> message and send a <b>LAM</b> message. Coordination status must change to <b>NEGOTIATING</b> .
2.4.3 From the ACC "B" system, send an <b>ACP</b> message	The ACC "A" system must receive an <b>ACP</b> message and send a <b>LAM</b> message. Coordination status must change to <b>COORDINATED</b> .	The ACC "B" system must send an <b>ACP</b> message and receive a <b>LAM</b> message. Coordination status must change to <b>COORDINATED</b> .
2.4.4 From the ACC "A" system, send a <b>TOC</b> message.	The ACC "A" system must send a <b>TOC</b> message and receive a <b>LAM</b> message. Coordination status must change to <b>TRANSFERRING</b> .	The ACC "B" system must receive a <b>TOC</b> message and send a <b>LAM</b> message. Coordination status must change to <b>TRANSFERRING</b> .
2.4.5 From the ACC "B" system, send an <b>AOC</b> message.	The ACC "A" system must receive an <b>AOC</b> message and send a <b>LAM</b> message. Coordination status must change to <b>TRANSFERRED</b> .	The ACC "B" system must send an <b>AOC</b> message and receive a <b>LAM</b> message. Coordination status must change to <b>TRANSFERRED</b> .

Example:

At 12:00 UTC

(FPL-TEST10-IS-B737/M-SW/C-SAAR1230-N0450F260 ROS UL550 LIM-SPIM0330-0)

**(Multiple) ABI / CPL / LAM / ACP / TOC / AOC TEST**

ACTION	EXPECTED RESPONSE ACC "A"	EXPECTED RESPONSE ACC "B"
2.4.6 Create and send an <b>FPL</b> for a flight leaving from an aerodrome in FIR "A" that is more than 30 minutes flight time from take-off to the coordination fix (FIR boundary), whose EOBT is less than 60 minutes from current time.	The ACC "A" system must send an <b>ABI</b> message and receive a <b>LAM</b> message. Coordination status must change to <b>NOTIFYING</b> .	The ACC "B" system must receive an <b>ABI</b> message and send a <b>LAM</b> message. Coordination status must change to <b>NOTIFYING</b> .
2.4.7 In the <b>FPL</b> template, make a change in EOBT, FL, ROUTE or DESTINATION.	The ACC "A" system must send an <b>ABI</b> message and receive a <b>LAM</b> message. Coordination must remain in <b>NOTIFYING</b> status.	The ACC "B" system must receive an <b>ABI</b> message and send a <b>LAM</b> message. Coordination must remain in the <b>NOTIFYING</b> status. The <b>FPL</b> must be modified according with the change made in the ACC "A" system.
2.4.8 Activate the <b>FPL</b> by inserting a take-off time (current time).	The ACC "A" system must <b>not</b> send any automatic message. Coordination must be in <b>NOTIFYING</b> status and the <b>FPL</b> change to ACTIVE mode.	Coordination must be in <b>NOTIFYING</b> status.
2.4.9 30 minutes before the time at which the activated flight must fly over the coordination fix, review the FPL template history.	The ACC "A" system must send a <b>CPL</b> message and receive a <b>LAM</b> message. Coordination status must change to <b>NEGOTIATING</b> .	The ACC "B" system must receive a <b>CPL</b> message and send a <b>LAM</b> message. Coordination status must change to <b>NEGOTIATING</b> and the <b>FPL</b> must change to ACTIVE mode.
2.4.10 From the ACC "B" system, send an <b>ACP</b> message.	The ACC "A" system must receive an <b>ACP</b> message and send a <b>LAM</b> message. Coordination status must change to <b>COORDINATED</b> .	The ACC "B" system must send an <b>ACP</b> message and receive a <b>LAM</b> message. Coordination status must change to <b>COORDINATED</b> .
2.4.11 From the ACC "A" system, send a <b>TOC</b> message.	The ACC "A" system must send a <b>TOC</b> message and receive a <b>LAM</b> message. Coordination status must change to <b>TRANSFERRING</b> .	The ACC "B" system must receive a <b>TOC</b> message and send a <b>LAM</b> message. Coordination status must change to <b>TRANSFERRING</b> .
2.4.12 From the ACC "B" system, send an <b>AOC</b> message.	The ACC "A" system must receive an <b>AOC</b> message and send a <b>LAM</b> message. Coordination status must change to <b>TRANSFERRED</b> .	The ACC "B" system must send an <b>AOC</b> message and receive a <b>LAM</b> message. Coordination status must change to <b>TRANSFERRED</b> .

Example:

At 12:00 UTC

(FPL-TEST11-IS-B737/M-SW/C-SAEZ1250-N0450F320 ATOVO UW5 ROS UL550 LIM-SPIM0430-0)

**2.5 ABI / CPL / LAM / ACP / CDN / TOC / AOC TEST**

ACTION	EXPECTED RESPONSE ACC "A"	EXPECTED RESPONSE ACC "B"
2.5.1 Create and send an <b>FPL</b> for a flight leaving from an aerodrome in FIR "A" that is <b>more than 30 minutes</b> flight time from take-off to the coordination fix (FIR boundary), whose EOBT is <b>at least 60 minutes</b> from current time.	The ACC "A" system must send an <b>ABI</b> message and receive a <b>LAM</b> message. Coordination status must change to <b>NOTIFYING</b> .	The ACC "B" system must receive an <b>ABI</b> message and send a <b>LAM</b> message. Coordination status must change to <b>NOTIFYING</b> .
2.5.2 Activate the <b>FPL</b> by inserting a take-off time (current time).	The ACC "A" system must <b>not</b> send any automatic message. Coordination must be in <b>NOTIFYING</b> status and the <b>FPL</b> must change to ACTIVE mode.	Coordination must be in <b>NOTIFYING</b> status.
2.5.3 30 minutes before the time at which the activated flight must fly over the coordination fix, review the FPL template history.	The ACC "A" system must send a <b>CPL</b> message and receive a <b>LAM</b> message. Coordination status must change to <b>NEGOTIATING</b> .	The ACC "B" system must receive a <b>CPL</b> message and send a <b>LAM</b> message. Coordination status must change to <b>NEGOTIATING</b> and the <b>FPL</b> change to ACTIVE mode.
2.5.4 From the ACC "B" system, send an <b>ACP</b> message.	The ACC "A" system must receive an <b>ACP</b> message and send a <b>LAM</b> message. Coordination status must change to <b>COORDINATED</b> .	The ACC "B" system must send an <b>ACP</b> message and receive a <b>LAM</b> message. Coordination status must change to <b>COORDINATED</b> .
2.5.5 From the ACC "A" system, send a <b>CDN</b> message.	The ACC "A" system must send a <b>CDN</b> message and receive a <b>LAM</b> message. Coordination status must change to <b>RE-NEGOTIATING</b> .	The ACC "B" system must receive a <b>CDN</b> message and send a <b>LAM</b> message. Coordination status must change to <b>RE-NEGOTIATING</b> .
2.5.6 From the ACC "B" system, send an <b>ACP</b> message.	The ACC "A" system must receive an <b>ACP</b> message and send a <b>LAM</b> message. Coordination status must change to <b>COORDINATED</b> .	The ACC "B" system must send an <b>ACP</b> message and receive a <b>LAM</b> message. Coordination status must change to <b>COORDINATED</b> .
2.5.7 From the ACC "A" system, send a <b>TOC</b> message.	The ACC "A" system must send a <b>TOC</b> message and receive a <b>LAM</b> message. Coordination status must change to <b>TRANSFERRING</b> .	The ACC "B" system must receive a <b>TOC</b> message and send a <b>LAM</b> message. Coordination status must change to <b>TRANSFERRING</b> .
2.5.8 From the ACC "B" system, send an <b>AOC</b> message.	The ACC "A" system must receive an <b>AOC</b> message and send a <b>LAM</b> message. Coordination status must change to <b>TRANSFERRED</b> .	The ACC "B" system must send an <b>AOC</b> message and receive a <b>LAM</b> message. Coordination status must change to <b>TRANSFERRED</b> .

Example:

At 12:00 UTC

(FPL-TEST12-IS-B737/M-SW/C-SAEZ1250-N0450F320 ATOVO UW5 ROS UL550 LIM-SPIM0430-0)

## **APPENDIX D AIDC OPERATIONS MANUAL**

### **1 INTRODUCTION**

1.1 The purpose of this manual is to make it easier for all ATS personnel involved to use the AIDC interface for successful and seamless automatic coordination between adjacent ACCs.

1.2 Accordingly, the manual has been conceived in a format that is easy to read, with specific instructions focusing on issues specifically related to AIDC, and, where possible, activity checklists. The manual is divided into sections intended for air traffic service personnel involved in flight and flight plan management.

1.3 It is important for each group of ATS personnel to become familiar with the content of this manual and, especially, the part that concerns them, and to keep it at hand for use as a reference when in doubt about how to proceed in a given situation.

1.4 An attempt has been made to include all possibly known situations. However, this manual does not intend to be exhaustive and it is foreseen that it will continue evolving as the use of the AIDC becomes widespread among ATS personnel.

### **2 TECHNICAL COMMUNICATIONS PERSONNEL (AFTN/AMHS)**

2.1 The technical communications personnel must provide on-going support, paying special attention to message traffic reception and delivery times, so they will not exceed the parameters established in the PAN NAT/APAC ICD and the SAM AIDC Guide, and to avoid timeout events.

### **3 ARO-AIS/COM PERSONNEL**

3.1 Upon receiving an FPL, the ARO-AIS/COM operator must make sure that it has been completed according to the instructions contained in the AIP.

3.2 Instructions for completing the flight plan form:

#### **ITEM 7: Aircraft identification (maximum 7 characters)**

Insert one of the following aircraft identifications, not exceeding 7 alphanumeric characters and without hyphens or symbols:

- a) the ICAO designator for the aircraft operating agency, followed by the flight identification (*e.g.*, KLM511, NGA213, JTR25) when the radiotelephony call sign to be used by the aircraft will consist of the ICAO telephony designator for the aircraft operating agency, followed by the flight identification (*e.g.*, KLM511, NIGERIA 213, JESTER 25); or
- b) the nationality or common mark and registration mark of the aircraft (*e.g.*, EIAKO, 4XBCD, N2567GA) when:
  - 1) the radiotelephony call sign to be used by the aircraft will consist of this identification alone (*e.g.*, CGAJS), or when preceded by the ICAO telephony designator for the aircraft operating agency (*e.g.*, BLIZZARD CGAJS);
  - 2) the aircraft is not equipped with radio;

Note 1. — Standards for nationality, common, and registration marks to be used are contained in Annex 7, Chapter 2.

**ITEM 8: Flight rules and type of flight (one or two characters)**

Flight rules. Insert one of the following letters to denote the category of flight rules with which the pilot intends to comply:

- I if it is intended that the entire flight will be operated under the IFR
- V if it is intended that the entire flight will be operated under the VFR
- Y if the flight initially will be operated under the IFR, followed by one or more subsequent changes of flight rules, or
- Z if the flight initially will be operated under the VFR, followed by one or more subsequent changes of flight rules

Specify in Item 15 the point(s) at which a change of flight rules is planned.

Type of flight: Insert one of the following letters to denote the type of flight when so required by the appropriate ATS authority:

- S if scheduled air service
- N if non-scheduled air transport operation
- G if general aviation
- M if military
- X if other than any of the defined categories above

Specify status of a flight following the indicator STS in Item 18, or when necessary to denote other reasons for specific handling by ATS, indicate the reason following the indicator RMK in Item 18.

**ITEM 9: Number and type of aircraft and wake turbulence category**

Number of aircraft (1 or 2 characters): Insert the number of aircraft, if more than one.

Type of aircraft (2 to 4 characters): Insert the appropriate designator, as specified in ICAO Doc 8643, Aircraft type designators or, if no such designator has been assigned, or in the case of formation flights comprising more than one type, insert ZZZZ and specify the number(s) and type(s) of aircraft in Item 18, preceded by TYP/.

Wake turbulence category (1 character): Insert an oblique stroke, followed by one of the following letters to indicate the wake turbulence category of the aircraft:

- H Heavy, to indicate an aircraft type with a maximum certificated take-off mass of 136,000 kg or more;
- M Medium, to indicate an aircraft type with a maximum certificated take-off mass of less than 136,000 kg, but more than 7,000 kg;
- L Light, to indicate an aircraft type with a maximum certificated take-off mass of 7,000 kg or less.

**ITEM 10: Equipment and capabilities**

Capabilities comprise the following elements:

1. presence of relevant serviceable equipment on board the aircraft;
2. equipment and capabilities commensurate with flight crew qualifications; and

3. where applicable, authorisation from the appropriate authority.

Radio communication, navigation and approach aid equipment and capabilities:  
Insert one letter, as follows:

- N if no COM/NAV/approach aid equipment for the route to be flown is carried, or the equipment is unserviceable; or
- S if standard COM/NAV/approach aid equipment for the route to be flown is carried and serviceable (see Note 1),

and/or insert one or more of the following letters to indicate the serviceable COM/NAV/approach aid equipment and capabilities available:

A	GBAS landing system	J7	CPDLC FANS 1/A SATCOM (Iridium)
B	LPV (APV with SBAS)	K	MLS
C	LORAN C	L	ILS
D	DME	M1	ATC RTF SATCOM (INMARSAT)
E1	FMC WPR ACARS	M2	ATC RTF (MTSAT)
E2	D-FIS ACARS	M3	ATC RTF (Iridium)
E3	PDC ACARS	O	VOR
F	ADF	P1- p9	Reserved for RCP
G	GNSS (see Note 2)	R	PBN approved (see Note 4)
H	HF RTF	T	TACAN
I	Inertial navigation	U	UHF RTF
J1	CPDLC ATN VDL Mode 2 (see Note 3)	V	VHF RTF
J2	CPDLC FANS 1/A VDL HF DL	W	RVSM approved
J3	CPDLC FANS 1/A VDL Mode A	X	MNPS approved
J4	CPDLC FANS 1/A VDL Mode 2	Y	VHF with 8.33 kHz channel separation capability
J5	CPDLC FANS 1/A SATCOM (INMARSAT)	Z	Other equipment carried or other capabilities (see Note 5)
J6	CPDLC FANS 1/A SATCOM (MTSAT)		

Any alphanumeric characters not indicated above are reserved.

Note 1. — If the S letter is used, standard equipment is considered to be VHF RTF, VOR, and ILS, unless another combination is prescribed by the appropriate ATS authority.

Note 2. — If the letter G is used, the types of external GNSS augmentation, if any, are specified in Item 18 following the indicator NAV/, and separated by a space.

Note 3. — See RTCA/EUROCAE Interoperability Requirements Standard For ATN Baseline 1 (ATN B1 INTEROP Standard – DO-280B/ED- 110B) for data link services / air traffic control clearance and information / air traffic control communications management / air traffic control microphone check.

Note 4. — If the letter R is used, the performance-based navigation levels that can be met are specified in Item 18 following the indicator PBN/. Guidance material on the application of performance-based navigation to a specific route segment, route, or area is contained in the Performance-based navigation manual (ICAO Doc 9613).

Note 5. — If the letter Z is used, specify in Item 18 the other equipment carried or other capabilities, preceded by COM/, NAV/ and/or DAT, as appropriate.

Note 6. — Information on navigation capability is provided to ATC for clearance and routing purposes.

Surveillance equipment and capabilities

Insert N if no surveillance equipment for the route to be flown is carried, or the equipment is unserviceable;

or

Insert one or more of the following descriptors, to a maximum of 20 characters, to describe the type of serviceable surveillance equipment and/or capabilities on board:

SSR Modes A and C

- A Transponder — Mode A (4 digits — 4 096 codes)
- C Transponder — Mode A (4 digits — 4 096 codes) and Mode C

SSR Mode S

- E Transponder — Mode S, including aircraft identification, pressure-altitude and extended squitter (ADS-B) capability
- H Transponder — Mode S, including aircraft identification, pressure-altitude and enhanced surveillance capability
- I Transponder — Mode S, including aircraft identification, but no pressure-altitude capability
- L Transponder — Mode S, including aircraft identification, pressure-altitude, extended squitter (ADS-B) and enhanced surveillance capability
- P Transponder — Mode S, including pressure altitude, but no aircraft identification capability
- S Transponder — Mode S, including both pressure-altitude and aircraft identification capability
- X Transponder — Mode S with neither aircraft identification nor pressure-altitude capability

Note.— Enhanced surveillance capability is the capability of the aircraft to down-link aircraft-derived data *via* a Mode S transponder.

ADS-B

- B1 ADS-B with dedicated 1090 MHz ADS-B “out” capability
- B2 ADS-B with dedicated 1090 MHz ADS-B “out” and “in” capability
- U1 ADS-B “out” capability using UAT
- U2 ADS-B “out” and “in” capability using UAT
- V1 ADS-B “out” capability using VDL Mode 4
- V2 ADS-B “out” and “in” capability using VDL Mode 4

ADS-C

- D1 ADS-C with FANS 1/A capabilities
- G1 ADS-C with ATN capabilities

Alphanumeric characters not indicated above are reserved.

Example: ADE3RV/HB2U2V2G1

Note.— Additional surveillance applications should be listed in Item 18, following the indicator SUR/.

**ITEM 13: Departure aerodrome and time (8 characters)**

Insert the ICAO 4-letter location indicator of the departure aerodrome, as specified in ICAO Doc 7910, Location indicators,

Or, if no location indicator has been assigned,

Insert ZZZZ, and specify, in Item 18, the name and location of the aerodrome, preceded by DEP/,

Or, the first point of the route or the marker radio beacon preceded by DEP/..., if the aircraft has not taken off from the aerodrome.

Or, if the flight plan is received from an aircraft in flight,

Insert AFIL, and specify, in Item 18, the ICAO four-letter location indicator of the ATS unit from which supplementary flight plan data can be obtained, preceded by DEP/.

Then, without a space,

Insert for a flight plan submitted before departure, the estimated off-block time (EOBT),

Or, for a flight plan received from an aircraft in flight, the estimated or actual time over the first point of the route to which the flight plan applies.

#### ITEM 15: Route

Insert the first cruising speed as in (a) and the first cruising level as in (b), without a space between them.

Then, following the arrow, insert the route description as in (c).

Cruising speed (maximum 5 characters)

Insert true airspeed for the first or the whole cruising portion of the flight, in terms of:

Kilometres per hour, expressed as K followed by 4 figures (*e.g.*, K0830), or

Knots, expressed as N followed by 4 figures (*e.g.*, N0485), or

True Mach number, when so prescribed by the appropriate ATS authority, to the nearest hundredth of unit Mach, expressed as M followed by 3 figures (*e.g.*, M082).

Cruising level (maximum 5 characters)

Insert the planned cruising level for the first or the whole portion of the route to be flown, in terms of:

Flight level, expressed as “F” followed by 3 figures (*e.g.*, F085; F330), or

\* Standard metric level in tens of metres, expressed as “S” followed by 4 figures (*e.g.*, S1130), or

Altitude in hundreds of feet, expressed as “A” followed by 3 figures (*e.g.*, A045; A100), or

Altitude in tens of metres, expressed as “M” followed by 4 figures (*e.g.*, M0840), or

For uncontrolled VFR flights, the letters “VFR”

\* When so prescribed by the appropriate ATS authorities.

c) Route (including changes of speed, level and/or flight rules)

Flights along designated ATS routes

Insert, if the departure aerodrome is located on, or connected to, the ATS route, the designator of the first ATS route,

Or, if the departure aerodrome is not on, or connected to, the ATS route, insert the letters “DCT” followed by the point of joining the first ATS route, followed by the designator of the ATS route.

THEN

Insert each point at which either a change of speed and/or level is planned to commence, or a change of ATS route, and/or a change of flight rules is planned,

Note. — When a transition is planned between a lower and upper ATS route and the routes are oriented in the same direction, the point of transition need not be inserted.

FOLLOWED, IN EACH CASE,

by the designator of the next ATS route segment, even if the same as the previous one,

Or, by DCT, if the flight to the next point will be outside a designated route, unless both points are defined by geographical coordinates.

Flights outside designated ATS routes

Insert points normally not more than 30 minutes flying time or 200 NM apart, including each point at which a change of speed or level, a change of track, or a change of flight rules is planned.

Or when required by the appropriate ATS authorities

Define the track of flights operating predominantly in an east-west direction between 70°N and 70°S by reference to significant points formed by the intersections of half or whole degrees of latitude with meridians spaced at intervals of 10 degrees of longitude. For flights operating in areas outside those latitudes the tracks shall be defined by significant points formed by the intersection of parallels of latitude with meridians normally spaced at 20 degrees of longitude.

The distance between significant points shall, as far as possible, not exceed one hour's flight time.

Additional significant points shall be established as deemed necessary. For flights operating predominantly in a north-south direction, define the tracks by reference to significant points formed by the intersection of whole degrees of longitude with specified parallels of latitude that are spaced at 5 degrees.

Insert DCT between successive points unless both points are defined by geographical coordinates or by bearing and distance.

Use ONLY the conventions in 1) to 5) below, and SEPARATE each sub-item by a space.

(1) ATS route (2 to 7 characters)

The coded designator assigned to the route or route segment (*e.g.*, W5, G12, UA570) including, where appropriate, the coded designator assigned to the standard departure or arrival route, as SIDs or STARs are published.

(2) Significant point (2 to 11 characters)

- 1) The coded designator (2 to 5 characters) assigned to the point (*e.g.*, LN, MAY, PADEX, SOLER).

NOTE: In airspaces under national jurisdiction, five (5) letters will be used for reporting points not defined by radio aids in ATS routes, as established in ENR 4.3.

If no coded designator has been assigned, use one of the following ways:

- Degrees only (7 characters): 2 figures describing latitude in degrees, followed by "N" (North) or "S" (South), then followed by 3 figures describing longitude in degrees, followed by "E" (East) or "W" (West). Make up the correct number of figures, where necessary, by insertion of zeros, for example, 36S063W.
- Degrees and minutes (11 characters): 4 figures describing latitude in degrees, and tens and units of minutes followed by "N" (North) or "S" (South), followed by 5 figures describing longitude in degrees and tens and units of minutes, followed by "E" (East) or "W" (West). Make up the correct number of figures, where necessary, by insertion of zeros, for example, 4620S07504W.
- Bearing and distance from a reference point: The identification of a navaid (normally a VOR) in the form of 2 or 3 characters; NEXT the bearing from the navaid, in the form of 3 figures, giving degrees magnetic; NEXT the distance from the navaid in the form of 3 figures expressing nautical miles. Make up the correct number of figures, where necessary, by insertion of zeros – *e.g.*, a point 180° magnetic at a distance of 40 nautical miles from VOR "UEN" should be expressed as UEN180040.
- Bearing and distance from a significant point: The identification of a reference point, followed by the bearing from the point in the form of 3 figures, giving degrees magnetic; then the distance

from the point in the form of 3 figures expressing nautical miles. In high-latitude areas where the appropriate authority determines that it is not practical to make reference to degrees magnetic, degrees true may be used. Make up the correct number of figures, where necessary, by insertion of zeros, for example, a point 180° magnetic at a distance of 40 NM from VOR “DUB” should be expressed as DUB180040.

(3) Change of speed or level (maximum 21 characters)

The point at which a change of speed (5% TAS or 0.01 Mach or more) or a change of level is planned to commence, expressed exactly as in 2) above, followed by an oblique stroke and both the cruising speed and the cruising level, expressed exactly as in a) and b) above, without a space between them, even when only one of these quantities will be changed.

Examples: LN/N0284A045  
MAY/N0305F180  
HADDY/N0420F330  
4602N07805W/N0500F350  
46N078W/M082F330  
DUB180040/N0350M0840

(4) Change of flight rules (maximum 3 characters)

The point at which the change of flight rules is planned, expressed exactly as in 2) or 3) above, followed by a space and one of the following:

VFR if from IFR to VFR  
IFR if from VFR to IFR  
Examples: PADEX VFR  
PADEX/N0280F050 IFR

(5) Cruise climb (maximum 28 characters)

The letter “C” followed by an oblique stroke, THEN the point at which cruise climb is planned to start, expressed as in 2) above, followed by an oblique stroke; THEN the speed to be maintained during cruise climb, expressed exactly as in a) above, followed by the two levels defining the layer to be occupied during cruise climb, each level expressed exactly as in b) above, or the level above which cruise climb is planned, followed by the letters “PLUS”, without a space between them:

Examples: C/48S050W/N0300F290F350  
C/48S050W/N0300F290PLUS

**ITEM 16: Destination aerodrome and total estimated elapsed time, destination alternate**

Destination aerodrome and total estimated elapsed time (8 characters):

Insert the ICAO 4-letter location indicator of the destination aerodrome, as specified in ICAO Doc 7910, Location indicators,

Or, if no location indicator has been assigned,

Insert ZZZZ and SPECIFY in Item 18 the name and location of the aerodrome, preceded by DEST/.

THEN WITHOUT A SPACE

INSERT the total estimated elapsed time.

Note. — For a flight plan received from an aircraft in flight, the total estimated elapsed time is the estimated time from the first point of the route to which the flight plan applies to the termination point of the flight plan.

Destination alternate

Insert the ICAO four-letter location indicators of no more than two alternate aerodromes, as specified in ICAO Doc 7910, Location indicators, separated by a space,  
Or, if no location indicator has been assigned to the alternate aerodromes,  
Insert ZZZZ and SPECIFY in Item 18 the name and location of the alternate aerodromes, preceded by ALTN/.

**ITEM 18:** Other information

Note. — Use of indicators not included under this item may result in data being rejected, processed incorrectly or lost.

Hyphens or oblique strokes must only be used as prescribed below.

Insert 0 (zero) if no other information,

Or, any other necessary information in the sequence shown hereunder, in the form of the appropriate indicator selected from those defined hereunder, followed by an oblique stroke and the information to be recorded:

STS/ Reason for special handling by ATS, for example, a search and rescue mission, as follows:

ALTRV:	for a flight operated in accordance with an altitude reservation;
ATFMX:	for a flight approved for exemption from ATFM measures by the appropriate ATS authority;
FFR:	fire-fighting;
FLTCK:	flight check for calibration of navaids;
HAZMAT:	for a flight carrying hazardous material;
HEAD:	for a flight with Head of State status;
HOSP:	for a medical flight declared by medical authorities;
HUM:	for a flight operating on a humanitarian mission;
MARSA:	for a flight for which a military entity assumes responsibility for separation of military aircraft;
MEDEVAC:	for a life critical medical emergency evacuation;
NONRVSM:	for a non-RVSM capable flight intending to operate in RVSM airspace;
SAR:	for a flight engaged in a search and rescue mission; and
STATE:	for a flight engaged in military, customs or police services.

Other reasons for special handling by ATS will be denoted under the designator RMK/.

PBN/	Indication of RNAV and/or RNP capabilities. Include as many of the descriptors below, as apply to the flight, up to a maximum of 8 entries, <i>i.e.</i> , a total of not more than 16 characters.
------	---

**RNAV SPECIFICATIONS**

A1	RNAV 10 (RNP 10)
B1	RNAV 5, all permitted sensors
B2	RNAV 5 GNSS
B3	RNAV 5 DME/DME
B4	RNAV 5 VOR/DME
B5	RNAV 5 INS or IRS
B6	RNAV 5 LORANC
C1	RNAV 2, all permitted sensors
C2	RNAV 2 GNSS
C3	RNAV 2 DME/DME
C4	RNAV 2 DME/DME/IRU
D1	RNAV 1, all permitted sensors

- D2 RNAV 1 GNSS
- D3 RNAV 1 DME/DME
- D4 RNAV 1 DME/DME/IRU

RNP SPECIFICATIONS

- L1 RNP 4
- O1 Basic RNP 1, all permitted sensors
- O2 Basic RNP 1 GNSS
- O3 Basic RNP 1 DME/DME
- O4 Basic RNP 1 DME/DME/IRU
- S1 RNP APCH
- S2 RNP APCH with BARO-VNAV
- T1 RNP AR APCH with RF (special authorisation required)
- T2 RNP AR APCH without RF (special authorisation required)

Combinations of alphanumeric characters not listed above are reserved.

- NAV/ Significant data related to navigation equipment, other than specified in PBN/, as required by the appropriate ATS authority. Indicate GNSS augmentation under this indicator, with a space between two or more methods of augmentation, *e.g.*, NAV/GBAS SBAS.
- COM/ Indicate communications applications or capabilities not specified in Item 10a.
- DAT/ Indicate data applications or capabilities not specified in Item 10a.
- SUR/ Include surveillance applications or capabilities not specified in Item 10b.
- DEP/ Name and location of departure aerodrome, if ZZZZ is inserted in Item 13, or the ATS unit for which supplementary flight plan data can be obtained, if AFIL is inserted in Item 13. For aerodromes not listed in the relevant aeronautical information publication, indicate location as follows:

With 4 figures describing latitude in degrees and tens and units of minutes followed by the letter “N” (North) or “S” (South), followed by 5 digits describing longitude in degrees and tens and units of minutes, followed by “E” (East) or “W” (West). Make up the correct number of figures, where necessary, by insertion of zeros, for example, 4620N07805W (11 characters).

Or, with the bearing and distance from the nearest significant point, as follows:

The identification of the significant point, followed by the bearing from the point in the form of 3 figures giving degrees magnetic, followed by the distance from the point in the form of 3 figures expressing nautical miles. In areas of high altitude where it is determined by the appropriate authority that reference to degrees magnetic is impractical, degrees true may be used.

Make up the correct number of figures, where necessary, by insertion of zeros, for example, a point 180° magnetic at a distance of 40 nautical miles from VOR “DUB” should be expressed as DUB180040.

Or, the first point of the route (name or LAT/LONG) or marker radio beacon, if the aircraft has not taken off from an aerodrome.

- DEST/ Name and location of destination aerodrome, if ZZZZ is inserted in Item 16. For aerodromes not listed in the aeronautical information publication, insert location in LAT/LONG or bearing and distance from the nearest significant point, as described under DEP/ above.
- DOF/ The date of flight departure in a six-figure format (YYMMDD), where YY equals the year, MM equals the month, and DD equals the day).
- REG/ The nationality or common mark and registration mark of the aircraft, if different from the aircraft identification in Item 7.
- EET/ Significant point or FIR boundary designators and total estimated elapsed time from take-off to such points or FIR boundaries, when so prescribed on the basis of regional air navigation agreements, or by the appropriate ATS authority.

Examples: EET/CAP0745 XYZ0830  
EET/EINN0204

- SEL/ SELCAL code, for aircraft so equipped.
- TYP/ Types of aircraft, preceded if necessary without a space by number of aircraft and separated by one space, if ZZZZ is inserted in Item 9.  
Example: TYP/2F15 5F5 3B2
- CODE/ Aircraft address (expressed in the form of an alphanumerical code of six hexadecimal characters) when required by the appropriate ATS authority.  
Example: "F00001" is the lowest aircraft address contained in the specific block administered by ICAO.
- DLE/ En-route delay or holding: insert the significant points on the route where a delay is planned to occur, followed by the length of delay using four figure time in hours and minutes (hhmm).

Example: DLE/MDG0030

- OPR/ ICAO designator or name of the operator, if different from the aircraft identification in Item 7.
- ORGN/ The originator's 8-letter AFTN address or other appropriate contact details, in cases where the originator of the flight plan may not be readily identified, as required by the appropriate ATS authority.

Note. — In some areas, flight plan reception centres may insert the ORGN/ identifier and originator's AFTN address automatically.

- PER/ Aircraft performance data, indicated by a single letter, as specified in the Procedures for air navigation services – Aircraft operations (PANS-OPS, ICAO Doc 8168), Volume I — Flight procedures, if so prescribed by the appropriate ATS authority.
- ALTN/ Name of destination alternate aerodromes, if ZZZZ is inserted in Item 16. For aerodromes not listed in the relevant aeronautical information publication, indicate location in LAT/LONG or the bearing and distance from the nearest significant point, as described in DEP/ above.
- RALT/ ICAO four-letter indicators for en-route alternates, as specified in ICAO Doc 7910, Location indicators, or name of en-route alternates, if no indicator is allocated. For aerodromes not listed in the relevant aeronautical information publication, insert location in LAT/LONG or bearing and distance from the nearest significant point, as described in DEP/ above.

TALT/ ICAO four-letter indicators for take-off alternates, as specified in ICAO Doc 7910, Location indicators, or name of take-off alternates, if no indicator is allocated. For aerodromes not listed in the relevant aeronautical information publication, indicate location in LAT/LONG or bearing and distance from the nearest significant point, as described in DEP/ above.

RIF/ The route details to the revised destination aerodrome, followed by the ICAO four-letter location indicator of said aerodrome. The revised route is subject to reclearance in flight.

Examples: RIF/DTA HEC KLAX  
RIF/ESP G94 CLA YPPH

RMK/ Any other plain language remarks when required by the appropriate ATS authority or deemed necessary.

**ITEM 19:** Supplementary information

Endurance: Insert a 4-figure group after E/ to indicate the fuel endurance in hours and minutes.

People on board: After P/, insert the total number of people (passengers and crew) on board, if prescribed by the appropriate ATS authority. Insert TBN (to be notified) if the total number of people is not known during flight plan filing.

Emergency and survival equipment:

R/(RADIO)

Cross out U if UHF on frequency 243.0 Mhz is not available

Cross out V if VHF on frequency 121.5 Mhz is not available

Cross out E if an emergency location transmitter (ELT) is not available

S/(SURVIVAL EQUIPMENT)

Cross out all indicators if survival equipment is not carried

Cross out P if polar survival equipment is not carried. Cross out D if desert survival equipment is not carried. Cross out M if maritime survival equipment is not carried.

Cross out J if jungle survival equipment is not carried.

J/(JACKETS)

Cross out all indicators if life jackets are not carried

Cross out L if life jackets are not equipped with lights. Cross out F if life jackets are not equipped with fluorescein. Cross out U or V or both, as in R/ above, to indicate radio capability of jackets, if any.

D/ (DINGHIES)

(NUMBER)

(CAPACITY)

Cross out indicators D and C if no dinghies are carried, and insert total capacity, number of persons, of all dinghies carried; and

(COVER)

Cross out indicator C if dinghies are not covered; and

(COLOUR)

Insert colour of dinghies if carried.

A/(COLOUR AND MARKINGS OF AIRCRAFT)

Insert the colour and significant markings of aircraft.

N/(REMARKS)

Cross out indicator N if no remarks, or indicate any other survival equipment carried and any other remarks regarding survival equipment.

C/(PILOT)

Insert the name of the pilot-in-command of the aircraft.

Submitted by: Insert the name of the unit, agency and/or person submitting the flight plan.

NOTE. — The aircraft commander or, in the case of commercial airlines, their designated representative, shall sign the PLN in the space reserved for additional requirements.

## REFERENCES

- AFIL: Flight plan filed in the air.
- DCT: Direct (in relation to flight plan clearances and type of approach).
- EET: Estimated elapsed time (for IFR flights, the estimated time required from take-off to arrive over that designated point, defined by reference to navigation aids, from which it is intended that an instrument approach procedure will be commenced, or, if no navigation aid is associated with the destination aerodrome, to arrive over the destination aerodrome. For VFR flights, the estimated time required from take-off to arrive over the destination aerodrome).
- ELT: Emergency locator transmitter.
- EOBT: Estimated off-block time (the estimated time at which the aircraft will commence movement associated with departure).
- HF RTF: High frequency in radiotelephony.
- PER: Aircraft performance data.
- RIF: Reclearance in flight (renewal of clearance in flight)
- RTF: Radiotelephony.
- STS: Reason for special handling by ATS.
- TBN: To be notified.
- TYP: Type of aircraft.
- UHF RTF: Ultra high frequency in radiotelephony.
- VHF RTF: Very high frequency in radiotelephony.

3.3 The ARO-AIS/COM office will not accept the FPL if it contains inconsistencies.

3.4 It shall receive and review ATS messages (FPL, CNL, CHG, DLA) sent by the operators.

3.5 It shall prepare and transmit ATS messages in the standard format and text, and in accordance with the conventional representation of data in those cases and conditions prescribed in Doc 4444 ATM/501, Appendix 3.

## **4 AERONAUTICAL INFORMATION MANAGEMENT (AIM) PERSONNEL FLIGHT DATA DISPLAY (FDD) OPERATORS**

4.1 The personnel responsible for modifying ATS messages received with errors shall proceed as follows:

- 1) Verify the ATS message is not duplicated. If duplicated, it shall be deleted.
- 2) Verify that the content of the message is in accordance with 2.2 of this document or with Doc 4444 ATM/501, Appendix 3, as appropriate. Once the error in the content has been corrected, the message shall be entered into the system.

Note. — If errors are found in Item 15 (Route) of an FPL, corrections will be made “only to the portion of the route that corresponds to its FIR”, leaving intact the data of other FIRs, except when absolutely necessary to ensure route continuity in the adjacent FIR(s).

## **5 CONTROL TOWER ATCO PERSONNEL**

5.1 It is expected that the AIDC will send ABI and EST messages based on the actual take-off time of the aircraft. However, when a flight is delayed, the ABI message will be sent based on the FPL EOBT, and then when the time comes for delivery of EST message, the system will send a PAC message.

5.2 This may result in undesired situations in which the receiving ACC receives automatic aircraft transfers that have not departed yet nor will depart in the next few minutes, thus creating confusion in the receiving FIR.

5.3 In order to avoid these situations, the EOBT must be updated based on the estimated time of departure, which shall be calculated by tower control personnel, based on tow or taxi estimates provided by the pilot, and the estimated departure calculated by the ATCO.

## **6 CONTROL CENTRE ATCO PERSONNEL**

6.1 An automation environment is aimed at reducing human intervention in the processes that take place to fulfil a specific task. In this regard, air traffic controllers shall take into account that data handling operations on ATC automated systems could disrupt some automatic processes or cause undesired results.

6.2 For this reason, while AIDC coordination is taking place, ATCOs shall avoid activating and/or manually assuming flights, unless strictly necessary, thus allowing automatic coordination to proceed.

6.3 There are 2 (two) possible configurations for the establishment of AIDC coordination between control centres:

- 1) using EST messages, or
- 2) using CPL messages

### **6.4 Using EST messages**

- 1° An FPL in "notified" status will be in a PRE-NOTIFYING coordination phase.
- 2° The system will send an ABI message and the coordination phase will change to NOTIFYING. (The system will send an ABI message whenever a change is made to EOBT, FL, ROUTE or DESTINATION data in the FPL.)
- 3° The system will send an EST message (if the duration of the flight from take-off to the COP is greater than the time specified in the database) or a PAC message (if the duration of the flight from take-off to the COP is less than that specified in the database) and the coordination phase will change to COORDINATING.
- 4° Acceptance can be automatic or manual, depending on system capacity and/or the decision of the ATSU. If manual, the ATCO of the adjacent ACC shall send an ACP message, and the coordination phase will change to COORDINATED.
- 5° The ATCO of the originating ACC or the ATCO of the receiving ACC may send a CDN message notifying or requesting a change in the FL and the coordination phase will change to RE-NEGOTIATING.

- 6° The ATCO that receives a CDN may send an ACP message or a CDN message with a different proposal. If the answer is an ACP message, coordination will return to the COORDINATED phase. If the answer is a CDN message, coordination will continue in the RE-NEGOTIATING phase until one of the ATCOs responds with an ACP message.
- 7° Under the circumstances defined in the Letter of Operational Agreement, the ATCO of the originating ACC shall make the transfer effective by sending a TOC message and coordination will change to TRANSFERRING.
- 8° The ATCO of the adjacent ACC shall send an AOC message accepting the transfer and the coordination status will change to TRANSFERRED.

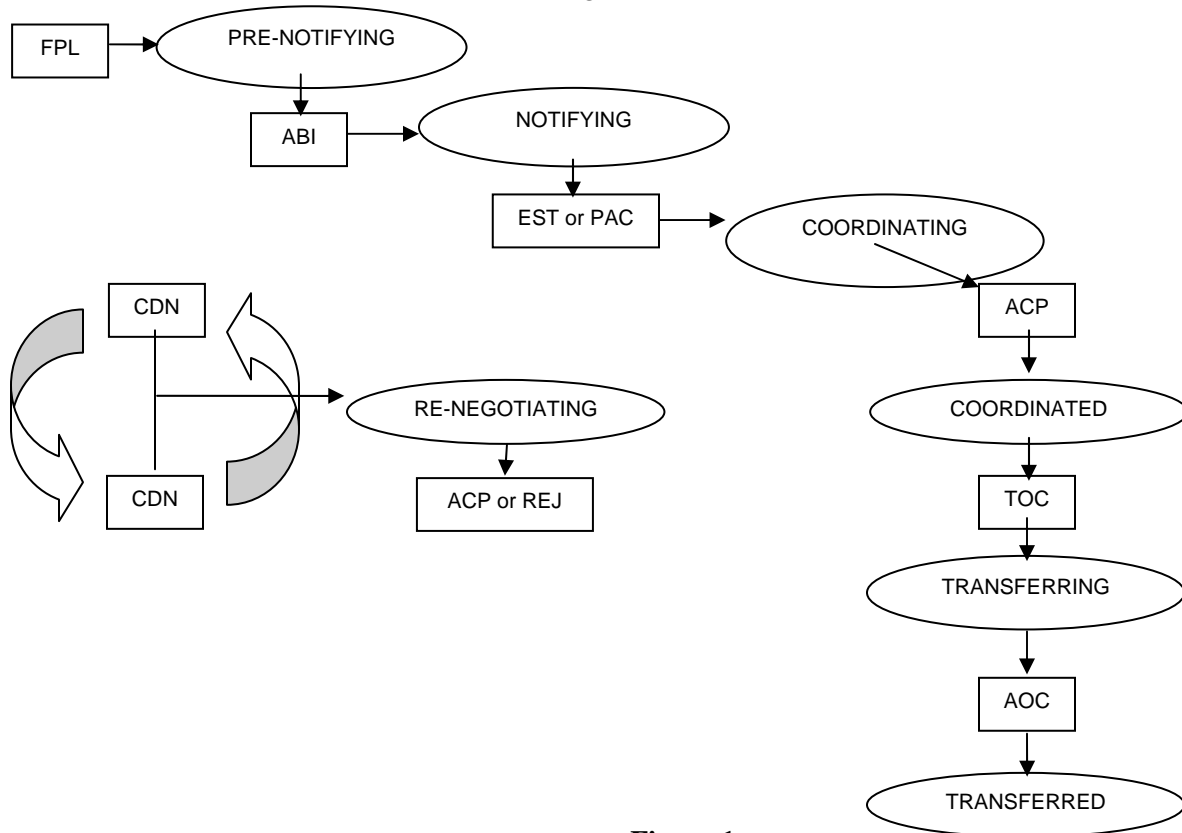
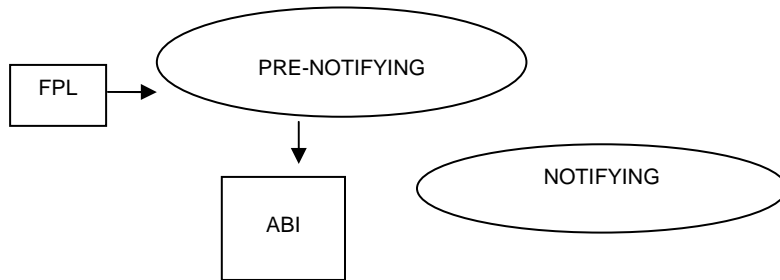

Figure 1

### 6.5 Using CPL messages

- 1° An FPL in "notified" status will be in the PRE-NOTIFYING coordination phase.
- 2° The system will send an ABI message and the coordination phase will change to NOTIFYING. (The system will send an ABI message whenever a change is made to EOBT, FL, ROUTE or DESTINATION data in the FPL.)
- 3° The system will send a CPL message and the coordination phase will change to NEGOTIATING.
- 4° The ATCO of the adjacent ACC shall send an ACP message or a CDN message with a different proposal. If the answer is an ACP message, coordination will change to the COORDINATED phase. If the answer is a CDN message, coordination will change to the RE-NEGOTIATING phase until one of the ATCOs responds with an ACP message, and the coordination phase will change to COORDINATED.
- 5° The ATCO of the originating ACC or the ATCO of the receiving ACC may send a CDN message notifying or requesting a change in the FL and the coordination phase will change to RE-NEGOTIATING.

- 6° The ATCO that receives a CDN may send an ACP message or a CDN message with a different proposal. If the answer is an ACP message, coordination will return to the CORDINATED phase. If the answer is a CDN message, coordination will continue in the RE-NEGOTIATING phase until one of the ATCOs responds with an ACP message.
- 7° Under the circumstances defined in the Letter of Operational Agreement, the ATCO of the originating ACC shall make the transfer effective by sending a TOC message and coordination will change to TRANSFERRING.
- 8° The ATCO of the adjacent ACC shall send an AOC message accepting the transfer and the coordination status will change to TRANSFERRED.



**Figure 2**

**APPENDIX E**

**COMPOSITION OF AIDC MESSAGES OF THE MINIMUM SET**

ATS message fields

Field	Element (a)	Element (b)	Element (c)	Element (d)	Element (e)
03	Message type designator	Message number	Reference data		
07	Aircraft identifier	SSR mode	SSR code		
09	Number of aircraft	Aircraft type	Wake turbulence category		
10	Radio communication and navigation and approach aid equipment and capabilities	Surveillance equipment and capabilities			
13	Aerodrome of departure	Time			
14	Control point	Time at control point	Cleared level	Supplementary data	Conditions
15	Cruising speed	Cruising level	Route		
16	Destination aerodrome	Total estimated elapsed time	Destination alternates		
18	Other data				
22	Field indicator	Modified data			
31	Facility designator	Sector designator			
32	Time	Position	Trace ground speed	Trace heading	Reported altitude

FPL (filed flight plan)

FPL field	Required elements	Optional elements	Comments
03	a. b.		
07	a.	b. c.	The SSR code is sent only if one has (already) been assigned and the aircraft is equipped for it.
08	a.	b.	Element (b) is included if so required by the boundary agreement.
09	b. c.	a.	
10	a. b.		
13	a. b.		
15	a. b. c.		
16	a. b.	c.	
18		a. Other information	Element (a) is included only if no other information is provided. Any element (a) or other information (but not both) must be included.

ABI (reporting message)

ABI field	Required elements	Optional elements	Comments
03	a.		Element (c) shall contain the reference number of the first message sent for this flight.
07	a.	b. c.	If an SSR code has been assigned, it must be included.
13	a.		
14	a. b. c. d. e.		
16	a.		
22			

CPL (current flight plan)

CPL field	Required elements	Optional elements	Comments
03	a. b.		
07	a.	b. c.	The SSR code is only sent if one has (already) been assigned and the aircraft is equipped for it.

08	a. b.		Element (b) is included if so required by the boundary agreement.
09	b. c.	a.	
10	a. b.		
13	a.		
14	a. b. c.	d. e.	
15	a. b. c.		
16	a.		
18		a. Other information	Element (a) is included only if no other information is included. Any element (a) or other information (but not both) must be included.

PAC (pre-activation)

PAC field	Required elements	Optional elements	Comments
03	a. b. c.		Element (c) shall contain the reference number of the last message sent for this flight.
07	a.	b. c.	The SSR code is only sent if one has already been assigned and the aircraft is equipped for it.
13	a.		The departure aerodrome must match the value previously sent in the FPL or the last CHG that modified the FPL.
14	a. b. c.	d. e.	Estimation data
16	a.		The destination aerodrome must match the value previously sent in the FPL or the last CHG that modified the FPL.
22			

MAC (coordination cancellation)

MAC field	Required elements	Optional elements	Comments
03	a. b. c.		Element (c) shall contain the reference number of the last message sent for this flight.
07	a.	b. c.	The SSR code is sent only if one has already been assigned and the aircraft is equipped for it.
13	a.		The departure aerodrome must match the value previously sent in the FPL or the last CHG that modified the FPL.
16	a.		The destination aerodrome must match the value previously sent in the FPL or the last CHG that modified the FPL.
22			

EST (estimates)

EST field	Required elements	Optional elements	Comments
03	a. b. c.		Element (c) shall contain the reference number of the last message sent for this flight.
07	a.	b. c.	The SSR code is sent only if one has already been assigned and the aircraft is equipped for it.
13	a.		The departure aerodrome must match the value previously sent in the FPL or the last CHG that modified the FPL.
14	a. b. c.	d. e.	
16	a.		The destination aerodrome must match the value previously sent in the FPL or the

			last CHG that modified the FPL.
--	--	--	---------------------------------

CDN (coordination message)

CDN field	Required elements	Optional elements	Comments
03	a. b. c.		
07	a.	b. c.	
13	a. b.		
14	a. b. c.	d.	
16	a.		

ACP (acceptance message)

ACP field	Required elements	Optional elements	Comments
03	a. b. c.		
07	a.	b. c.	
13	a. b.		
16	a.		

RJC (rejection message)

RJC field	Required elements	Optional elements	Comments
03	a. b. c.		
07	a.	b. c.	
13	a. b.		
16	a.		

TOC (transfer of control message)

TOC field	Required elements	Optional elements	Comments
03	a. b. c.		
07	a.	b. c.	
13	a. b.		
16	a.		

AOC (assumption of control)

AOC field	Required elements	Optional elements	Comments
03	a. b. c.		
07	a.	b. c.	
13	a. b.		
16	a.		

LAM (logical acknowledgment message)

LAM field	Required elements	Optional elements	Comments
03	a. b. c.		

LRM (logical rejection message)

LRM field	Required elements	Optional elements	Comments
03	a. b. c.		
18	Text as shown in Comments		Describes the error code: after RMK /, includes two digits for the error code.

## APPENDIX F

### LIST OF ACRONYMS

ABI	Advance Boundary Information (AIDC message)
ACC	Area Control Centre
ACP	Acceptance (AIDC message)
ADS	Surveillance ADS-C (AIDC message)
ADS-B	Automatic Dependent Surveillance - Broadcast
ADS-C	Automatic Dependent Surveillance - Contract
AFTN	Aeronautical Fixed Telecommunications Network
AFTN	Aeronautical Fixed Telecommunications Network
AIDC	ATS Interfacility Data Communications
AMHS	Aeronautical Message Handling System
AMHS	ATS Message Handling System
AOC	Airline Operational Control; or Assumption of Control (AIDC message)
APP	Approach Control Office
ASCII	American Standard Code for Information Interchange
ASIA/PAC	Asia/Pacific
ATC	Air Traffic Control
ATM	Air Traffic Management
ATN	Aeronautical Telecommunication Network
ATS	Air Traffic Service
ATSU	Air Traffic Service Unit
CAAS	Common AMHS Addressing Scheme
CARSAM	Caribbean – South America
CCAM	<i>Centro de Conmutación Automática de Mensajes</i> (automatic message switching centre)
CDN	Coordination (AIDC message)
CH	AFTN Channel
CHG	ICAO Modification Message
CNS	Communications, Navigation, Surveillance
CPDLC	Controller Pilot Data Link Communications
CPL	Current Flight Plan (AIDC message)
DS	Directory server that communicates using X.500 protocols
DS	Directory Service
EST	Coordination Estimate (AIDC message)
FPL	Filed Flight Plan
IA-5	International Alphabet 5
ICAO	International Civil Aviation Organization
ICD	Interface Control Document
IP	Internet Protocol
IPM	Inter Personal Message
IPv4	Internet Protocol version 4
IPv4 REDDIG SAM:	IP addressing plan, version 4. Uses the REDDIG and corresponds to the SAM Region
ITA-2	International Telegraph Alphabet No. 2
LAM	Logical Acknowledgment Message (AIDC message)
LRM	Logical Rejection Message (AIDC message)
MS	Message storage for handling message delivery and retrieval
MTA	Agent responsible for routing messages between MTAs, MSs, and UAs - Message Transfer Agent

MTCU	Message Transfer and Conversion Unit
NAT	Network Address Translation
NAT	IP address translation protocol
OSI	Open System Interconnection
P1	Protocol for communicating and routing messages between MTAs (ITU-T X.411)
P3	Delivery protocol (“pull” type)
P7	Protocol for the UA to withdraw from MS (ITU-T X.413) (“push” type)
REDDIG	South American Digital Network
REDDIG LAN	Environment associated to the regional IP addressing plan for each State
REDDIG WAN	Environment associated to the regional IP addressing plan for interconnection between States
REJ	Rejection (AIDC message)
Speech ATS	Speech circuit for ATS communications
TCP	Transfer of Control Point
TOC	Transfer of Control (AIDC message)
TWR	Aerodrome control tower
UA	User Agent
UTC	Universal Coordinated Time

## APPENDIX B

## (AIDC) GROUND-GROUND DATA INTERCONNECTION LEVEL REQUIREMENTS IN THE SAM REGION

ARGENTINA						
ACC	ACC ADJ	Flight plan				Comments
		Interconnection levels *				
		1 4444 Manual	2 4444 Auto	3 (OLDI)	4 (AIDC)	
CORDOBA (AUT. INDRA AIRCON2100) (2007)	IQUIQUE	XI			X	Positive AIDC trials - March 2016 As a result of the trials, the transmission speed has to be incremented from 2400 to 9600 bit/seg AIDC foreseen to be operational on the first semester of 2017
	LA PAZ	XI			X	AIDC foreseen for period 2017-2019
	EZEIZA	XI			XI	AIDC in pre-operational phase since December 2015. Operational phase foreseen by the first semester of 2017
	MENDOZA	XI			X	AIDC pre-operational by the first semester of 2017
	RESISTENCIA	XI			X	AIDC pre-operational by the first semester of 2017
RESISTENCIA (AUT. INDRA AIRCON2100) (June 2016)	ASUNCION	XI			X	Positive AIDC trials were conducted in 2015 between Ezeiza and Asunción. Trials between Resistencia and Asunción will be conducted on mid-2016 AIDC foreseen to be operational by the first semester of 2017
	CORDOBA	XI			X	AIDC pre-operational by the first semester of 2017
	CURITIBA	XI			X	AIDC foreseen by the first semester of 2017
	EZEIZA	XI			X	AIDC pre-operational by the first semester of 2017
	MONTEVIDEO	XI			X	AIDC foreseen by the first semester of 2017
EZEIZA (AUT. INDRA AIRCON2100) (2007)	COMODORO RIVADAVIA	XI			X	AIDC pre- by the first semester of 2017
	MENDOZA	XI			X	AIDC pre-operational by the first semester of 2017

	PUERTO MONTT	XI			X	AIDC by the first semester of 2017
	CORDOBA	XI			XI	AIDC in pre-operational phase since December 2015. Operational phase foreseen by the first semester of 2017
	RESISTENCIA	XI			X	AIDC pre-operational by the first semester of 2017
	JOHANNESBURG	XI			X	AIDC TBD
	MONTEVIDEO	XI			X	AIDC foreseen for the first semester of 2017
MENDOZA (AUT INDRA AIRCON2100) (June 2016)	EZEIZA	XI			X	AIDC pre-operational by the first semester of 2017
	SANTIAGO	XI			X	AIDC foreseen for period 2017-2019
	CORDOBA	XI			X	AIDC pre-operational by the first semester of 2017
COMODORO RIVADAVIA (AUT INDRA AIRCON2100) (June 2016)	EZEIZA	XI			X	AIDC pre-operational by the first semester of 2017
	PUNTA ARENAS	XI			X	AIDC by the first semester of 2017
	PUERTO MONTT	XI			X	AIDC by the first semester of 2017

BRAZIL						
ACC	ACC ADJ	Flight plan				Comments
		Interconnection levels				
		1 4444 Manual	2 4444 Auto	3 (OLDI)	4 (AIDC)	
AMAZÓNICO (MANAUS) AUTO. SAGITARIO ATECH	BRASILIA	XI			XI	AIDC implemented June 2016
	BOGOTÁ	XI			X	AIDC operational foreseen by December 2016
	CAYENNE	XI			X	AIDC foreseen for the first semester of 2017
	CURITIBA	XI			XI	AIDC implemented July 2016
	GEORGETOWN	XI			X	AIDC foreseen for period 2017-2019
	LA PAZ	XI			X	AIDC foreseen for period 2017-2019
	LIMA	XI			X	AIDC foreseen for December 2016
	MAIQUETIA	XI	X		X	AIDC foreseen for period 2017-2019
	PARAMARIBO	XI			X	AIDC foreseen for period 2017-2019
	RECIFE	XI			X	AIDC implemented since 2 May 2016
CAYENNE	XI			X	AIDC foreseen for period 2017-2019	

	ATLÂNTICO	XI			X	May 2017
BRASILIA AUTO. SAGITARIO ATECH	AMAZÔNICO	XI			XI	AIDC implemented June 2016
	CURITIBA	XI			XI	AIDC implemented July 2016
	RECIFE	XI			XI	AIDC implemented June 2016
	AMAZONICO	XI			XI	AIDC implemented July 2016
CURITIBA AUTO. SAGITARIO ATECH	ASUNCION	XI			X	AIDC foreseen by December 2016
	BRASÍLIA	XI			Xi	AIDC implemented July 2016
	LA PAZ	XI			X	AIDC foreseen for period 2017-2019
	MONTEVIDEO	XI			X	AIDC foreseen for the first semester of 2017
	RECIFE	XI			XI	AIDC implemented July 2016
	RESISTÊNCIA	XI			X	AIDC foreseen for the first semester of 2017
	ATLÂNTICO	XI			X	May 2017
	AMAZÔNICO	XI			X	AIDC Implemented on 2 May 2016
RECIFE AUTO. SAGITARIO ATECH	BRASÍLIA	XI			XI	AIDC implemented June 2016
	CURITIBA	XI			XI	AIDC implemented July 2016
	ATLÂNTICO	XI			X	May 2017
	AMAZÔNICO	XI			X	May 2017
ATLÂNTICO AUTO. SAGITARIO ATECH	CURITIBA	XI			X	May 2017
	DAKAR	XI			X	AIDC TBD
	JOHANNESBURG	XI			X	AIDC TBD
	LUANDA	XI			X	AIDC TBD
	MONTEVIDEO	XI			X	AIDC foreseen for period 2017-2019
	RECIFE	XI			X	May 2017
	CAYENNE	XI			X	AIDC foreseen for period 2017-2019

BOLIVIA						
ACC	ACC ADJ	Flight plan				Comments
		Interconnection levels				
		1 4444 Manual	2 4444 Auto	3 (OLDI)	4 (AIDC)	
LA PAZ (MANUAL)	AMAZÔNICO	XI			X	AIDC foreseen for period 2017-2019
	ASUNCION	XI			X	AIDC foreseen for period 2017-2019
	CURITIBA	XI			X	AIDC foreseen for period 2017-2019

	CORDOBA	XI			X	AIDC foreseen for period 2017-2019
	LIMA	XI			X	AIDC foreseen for period 2017-2019
	IQUIQUE	XI			X	AIDC foreseen for period 2017-2019

CHILE						
ACC	ACC ADJ	Flight plan				Comments
		Interconnection levels				
		1 4444 Manual	2 4444 Auto	3 (OLDI)	4 (AIDC)	
SANTIAGO (AUTO THALES TOPSKY)	IQUIQUE	XI			X	AIDC foreseen for period 2017-2019
	LIMA	XI			X	AIDC foreseen for period 2017-2019
	MENDOZA	XI			X	AIDC foreseen for period 2017-2019
	PUERTO MONTT	XI			X	AIDC foreseen for period 2017-2019
IQUIQUE (AUTO INDRA AIRCON 2100)	CORDOBA	XI			X	Positive AIDC trials - March 2016 Trial results indicate the necessity of increase transmission speed from 2400 to 9600 bit/sec. AIDC operational foreseen by the first semester of 2017
	LA PAZ	XI			X	AIDC foreseen for period 2017-2019
	LIMA	XI			X	Positive AIDC trials conducted in February 2016 AIDC foreseen to be operational by the first semester of 2017
PUERTO MONTT (INDRA AUTOMATED)	SANTIAGO	XI			X	AIDC foreseen for period 2017-2019
	PUNTA ARENAS	XI			X	AIDC foreseen by the first semester of 2017
	EZEIZA	XI			X	AIDC by the first semester of 2017
	COMODORO RIVADAVIA	XI			X	AIDC by the first semester of 2017
PUNTA ARENAS (MANUAL)	PUERTO MONTT	XI			X	AIDC by the first semester of 2017
	COMODORO RIVADAVIA	XI			X	AIDC by the first semester of 2017

COLOMBIA						
ACC	ACC ADJ	Flight plan				Comments
		Interconnection levels				
		1 4444 Manual	2 4444 Auto	3 (OLDI)	4 (AIDC)	
BOGOTÁ (AUTO INDRA AIRCON 2100)	AMAZÔNICO	XI			X	AIDC foreseen to be operational on second half of 2016
	CENAMER	XI			X	AIDC foreseen for period 2017-2019
	GUAYAQUIL	XI			XI	Positive AIDC trials conducted  AIDC in pre-operational phase (August 2015)
	LIMA	XI			XI	Positive AIDC trials conducted  AIDC pre-operational (August 2015)  Letter of operational agreement foreseen to be signed at the SAM/IG/18
	MAIQUETIA	XI			X	AIDC foreseen for period 2017-2019
	PANAMA	XI			X	Positive AIDC trials conducted AIDC foreseen to be operational by first semester 17
	BARRANQUILLA	XI			XI	AIDC pre-operational (March 2016)
BARRANQUILLA (AUTO INDRA AIRCON 2100)	MAIQUETIA	XI			X	AIDC foreseen for period 2017-2019
	PANAMA	XI			X	Positive AIDC trials conducted  AIDC foreseen to be operational by first semester 2017
	BOGOTA	XI			XI	AIDC pre-operational (March 2016)
	KINGSTON	XI			X	AIDC TBD
	CURAÇAO	XI			X	AIDC TBD

<b>ECUADOR</b>						
ACC	ACC ADJ	Flight plan				Comments
		Interconnection levels				
		1 4444 Manual	2 4444 Auto	3 (OLDI)	4 (AIDC)	
GUAYAQUIL AUTO INDRA AIRCON 2100	BOGOTA	XI			XI	Positive AIDC trials conducted AIDC pre-operational (August 2015)
	LIMA				XI	AIDC operational implementation (31 March 2016)
	CENAMER	XI			X	Positive AIDC trials conducted AIDC foreseen for period 2017-2019

<b>FRENCH GUIANA</b>						
ACC	ACC ADJ	Flight plan				Comments
		Interconnection levels				
		1 4444 Manual	2 4444 Auto	3 (OLDI)	4 (AIDC)	
CAYENNE AUTO ADACEL AIDC not installed	AMAZÓNICO	XI			X	AIDC foreseen by first semester 2017
	PARAMARIBO	XI			X	AIDC foreseen for period 2017-2019
	PIARCO	XI			X	AIDC foreseen for period 2017-2019
	DAKAR	XI			X	AIDC foreseen by end 2016
	ATLANTICO	XI			X	AIDC foreseen by first semester 2017

<b>GUYANA</b>						
ACC	ACC ADJ	Flight plan				Comments
		Interconnection levels				
		1 4444 Manual	2 4444 Auto	3 (OLDI)	4 (AIDC)	
GEORGETOWN AUTO INTELCAN AIDC not installed	AMAZONICO	XI			X	AIDC foreseen for period 2017-2019
	PIARCO	XI			X	AIDC foreseen for period 2017-2019
	MAIQUETIA	XI			X	AIDC foreseen for period 2017-2019
	PARAMARIBO	XI			X	AIDC foreseen for period 2017-2019

PANAMA						
ACC	ACC ADJ	Flight plan				Comments
		Interconnection levels				
		1 4444 Manual	2 4444 Auto	3 (OLDI)	4 (AIDC)	
PANAMA (AUTO THALES)	BOGOTA	XI			X	Positive AIDC trials conducted AIDC foreseen to be operational by first semester 2017
	BARRANQUILLA	XI			X	Positive AIDC trials conducted AIDC foreseen to be operational by first semester 2017
	CENAMER	XI			X	Positive AIDC trials conducted AIDC foreseen to be operational by the end of the first semester 2017

PARAGUAY						
ACC	ACC ADJ	Flight plan				Comments
		Interconnection levels				
		1 4444 Manual	2 4444 Auto	3 (OLDI)	4 (AIDC)	
ASUNCION AUTO AIRCON 2100 INDRA	CURITIBA	XI			X	AIDC foreseen by December 2016
	LA PAZ	XI			X	AIDC foreseen for period 2017-2019
	RESISTÊNCIA	XI			X	Positive AIDC trials conducted in 2015 between Ezeiza and Asunción. Trials between Resistencia and Asunción will be conducted on mid 2016  AIDC foreseen to be operational by first semester 2017

PERU						
ACC	ACC ADJ	Flight plan				Comments
		Interconnection levels				
		1 4444 Manual	2 4444 Auto	3 (OLDI)	4 (AIDC)	
LIMA AUTO AIRCON 2100 INDRA	AMAZONICO	XI			X	AIDC foreseen to be operational by December 2016
	BOGOTA	XI			XI	Positive AIDC trials conducted  AIDC pre-operational phase (August 2015)  Letter of operational agreement foreseen to be sign at the SAM/IG/18
	SANTIAGO	XI			X	AIDC foreseen for period 2017-2019
	IQUIQUE	XI			X	Positive AIDC trials conducted in February 2016 AIDC foreseen to be operational by first semester 2017
	GUAYAQUIL	XI			XI	AIDC operational (31 March 2016)
	LA PAZ	XI			X	AIDC foreseen for period 2017-2019

SURINAME						
ACC	ACC ADJ	Flight plan				Comments
		Interconnection levels				
		1 4444 Manual	2 4444 Auto	3 (OLDI)	4 (AIDC)	
PARAMARIBO (AUTO INTELCAN)  AIDC not installed	AMAZÓNICO	XI			X	AIDC foreseen for period 2017-2019
	GEORGETOWN	XI			X	AIDC foreseen for period 2017-2019
	PIARCO	XI			X	AIDC foreseen for period 2017-2019
	CAYENNE	XI			X	AIDC foreseen for period 2017-2019

URUGUAY						
ACC	ACC ADJ	Flight plan				Comments
		Interconnection levels				
		1 4444 Manual	2 4444 Auto	3 (OLDI)	4 (AIDC)	
MONTEVIDEO (AUTO INDRA AIRCON2100)	CURITIBA	XI			X	AIDC foreseen by first semester 2017
	EZEIZA	XI			X	AIDC foreseen by first semester 2017
	RESISTENCIA	XI			X	AIDC foreseen by first semester 2017
	ATLANTICO	XI			X	AIDC foreseen for period 2017-2019
	JOHANNESBURG	X			X	AIDC TBD

VENEZUELA						
ACC	ACC ADJ	Flight plan				Comments
		Interconnection levels				
		1 4444 Manual	2 4444 Auto	3 (OLDI)	4 (AIDC)	
MAIQUETIA (AUTO ATECH X4000) AIDC not installed	AMAZONICO	XI	XI		X	AIDC foreseen for period 2017-2019
	BOGOTA	XI			X	AIDC foreseen for period 2017-2019
	BARRANQUILLA	XI			X	AIDC foreseen for period 2017-2019
	PIARCO	XI			X	AIDC TBD
	CAYENNE	XI			X	AIDC foreseen for period 2017-2019
	CURAZAO	XI			X	AIDC TBD
	SAN JUAN	XI			X	AIDC TBD

\* X PLANNED

\*XI IMPLEMENTED AND IN PRE-OPERATIONAL OR OPERATIONAL PHASE

## APPENDIX C

## PLAN OF ACTIVITIES FOR THE IMPLEMENTATION OF THE AIDC INTERCONNECTION BETWEEN ADJACENTS ACCs

	Start	End	Responsible party	Status
<b>1. Establishment of initial activities for completing the technical implementation of AIDC</b>	<b>10/10/2014</b>	<b>16/10/2014</b>	<b>ICAO</b>	<b>Completed</b>
<p>1.1 Based on the results of AIDC tests conducted from February 2014 to June 2014, the technical documentation of the automated systems installed in the Region, and the SAM AIDC implementation guide, develop:</p> <p>1.1.1 Plan of activities to complete technical feasibility tests for AIDC interconnection between:</p> <p style="padding-left: 40px;">Santiago ACC - Lima ACC Guayaquil ACC - Lima ACC Bogota ACC - Guayaquil ACC</p> <p>1.1.2 Contents of AIDC course for ATS controllers and programmers of AIDC automated system databases, to be conducted in Chile, Colombia, Ecuador and Peru.</p>	10/10	16/10	ICAO	<p>The initial plan of activities for AIDC implementation is scheduled for 2015. The plan of activities contemplates the conduction of AIDC courses for air traffic controllers working at ACCs and the operational implementation of AIDC between adjacent ACCs.</p> <p>These activities will be conducted in Chile, Colombia, Ecuador and Peru.</p> <p>Interconnection tests between the Lima and Bogota ACCs were added to the list shown in paragraph 1.1.1.</p>
<b>2. Review of activities at the SAM/IG/14 meeting</b>	<b>09/10</b>	<b>13/11</b>	<b>ICAO and SAM/IG group</b>	<b>Completed</b>
2.1 Submission of the plan of activities and contents of the AIDC course at the SAM/IG/14 meeting	09/10	13/11	ICAO	
2.2 Review and approval for submission at the Eighth Coordination Meeting of Project RLA/06/901	09/10	13/11	SAM/IG	

	<b>Start</b>	<b>End</b>	<b>Responsible party</b>	<b>Status</b>
<b>3. Approval of activities by the RCC/8 meeting</b>	<b>25/02/15</b>	<b>27/02/15</b>	<b>RLA/06/901 member States</b>	<b>Completed</b> The RCC/8 meeting held in Lima on 25-27 February 2015 approved the activities for initial implementation of AIDC interconnection in Chile, Colombia, Ecuador and Peru.
3.1 Submission of activities, with their respective cost, for approval.	25/02/15	27/02/15	RLA/06/901 member States	
<b>4. Search and selection of experts</b>	<b>24/11/14</b>	<b>28/01/15</b>	<b>ICAO</b>	<b>Completed</b> For the performance of the initial activities, three SAM experts with experience in database programming and operation of ACC automated systems were selected: <b>Rubén Silva of Argentina, Mauricio Ferrer of Colombia, and Jorge Merino of Peru.</b>
4.1 Search and selection of 4 experts from SAM States participating in Project RLA/06/901, with experience in the installation, operation and programming of AIDC databases, to perform the activities listed in item 1.	24/11/14	28/01/15	ICAO	
<b>5. Missions to complete AIDC interconnection between States that started tests during the first semester of 2014</b>	<b>06/04/15</b>	<b>01/05/15</b>	<b>3 automation experts ICAO</b>	<b>Completed</b> Missions were conducted for training purposes and to complete tests for AIDC interconnection and operation  <b>Chile 6/4 to 10/4/2015</b> <b>Peru 13/4 to 17/4/2015</b> <b>Ecuador 20/4 to 24/4/2015</b> <b>Colombia 27/4 to 1/5/2015</b>

	<b>Start</b>	<b>End</b>	<b>Responsible party</b>	<b>Status</b>
5.1 Mission to Santiago de Chile	13/04/15	17/04/15	3 automation experts ICAO	<b>Completed</b> Implementation of AIDC activities at the Santiago ACC <ul style="list-style-type: none"> <li>• AIDC practical course</li> <li>• AIDC interconnection tests between: <i>Santiago ACC and Lima ACC</i></li> </ul>
5.1.1 Complete AIDC technical implementation between the Santiago and Lima ACCs	13/04/15	17/04/15	3 automation experts ICAO	Two-way communication was established in the AIDC interconnection tests between the Thales Top sky system of the Santiago ACC and the INDRA Aircon 2100 of the Lima ACC. The operational tests did not have positive results due to the AIDC limitations in the Santiago ACC.  The practical course on AIDC and database programming was conducted, providing training to 16 controllers of the Santiago ACC and 2 aeronautical technicians.
5.1.2 Conduct AIDC course for ATS personnel of the Santiago ACC	13/04/15	17/04/15		
5.2 Mission to Lima:	13/04/15	17/04/15	3 automation experts	<b>Completed</b> Implementation of AIDC activities in the Lima ACC <ul style="list-style-type: none"> <li>• AIDC practical course</li> <li>• AIDC interconnection tests between:</li> </ul>

	<b>Start</b>	<b>End</b>	<b>Responsible party</b>	<b>Status</b>
				<i>Lima ACC - Santiago ACC Lima ACC - Guayaquil ACC Lima ACC - Bogota ACC</i>
5.2.1 Conduct AIDC course for ATS personnel of the Lima ACC	13/04/15	17/04/15	3 Automation experts ICAO	The practical course on AIDC and database programming was conducted, providing training to 44 controllers of the Lima ACC.
5.2.2 Complete AIDC tests between the Lima ACC and the Guayaquil ACC	13/04/15	17/04/15		AIDC tests between the Lima and Guayaquil ACCs were successfully conducted.
5.2.3 Complete AIDC tests between the Lima ACC and the Bogota ACC	13/04/15	17/04/15		AIDC tests between the Lima and Bogota ACCs were successfully conducted.
5.3 Mission to Guayaquil	20/04/15	24/04/15	3 Automation experts of the SAM Region	<b>Completed</b> Implementation of AIDC activities at the Guayaquil ACC <ul style="list-style-type: none"> <li>• Practical course on AIDC</li> <li>• AIDC interconnection tests and pre-operational implementation: Guayaquil ACC - Lima ACC Guayaquil ACC- Bogota ACC</li> </ul>
5.3.1 Complete AIDC technical implementation between the Guayaquil ACC and the Lima ACC	20/04/15	24/04/15	3 automation experts of the SAM Region	AIDC technical interconnection was completed, currently in the pre-operational phase.

	<b>Start</b>	<b>End</b>	<b>Responsible party</b>	<b>Status</b>
5.3.2 Complete AIDC technical implementation between the Guayaquil ACC and the Bogota ACC	20/04/15	24/04/15		AIDC technical interconnection was completed, currently in the pre-operational phase
5.3.2 Conduct AIDC course for ATS personnel of the Guayaquil ACC	20/04/15	24/04/15		The practical course on AIDC and database programming was conducted, providing training to 31 controllers of the Guayaquil ACC.
5.4 <i>Mission to Bogota</i>	<b>27/04/15</b>	<b>01/05/15</b>	<b>3 automation experts</b>	<b>Completed</b> Implementation of AIDC activities in the Bogota ACC <ul style="list-style-type: none"> <li>• Practical course on AIDC</li> <li>• AIDC interconnection tests and pre-operational implementation:</li> </ul> <i>Guayaquil ACC - Lima ACC</i> <i>Guayaquil ACC - Bogota ACC</i>
5.4.1 Complete AIDC technical implementation between the Bogota ACC and the Guayaquil ACC	27/04/15	01/05/15	3 automation experts of the SAM Region	The AIDC technical interconnection was completed, currently in pre-operational phase
5.4.2 Complete AIDC technical implementation between the Bogota ACC and the Lima ACC	27/04/15	01/05/15		The AIDC technical interconnection was completed, currently in pre-operational phase

	<b>Start</b>	<b>End</b>	<b>Responsible party</b>	<b>Status</b>
<b>6. First meeting of the AIDC operational implementation working group during the SAMIG/15 meeting</b>	<b>11/05/15</b>	<b>15/05/15</b>	<b>RLA/06/901 member States</b>	<b>Completed.</b> As a result of AIDC technical implementation, the SAM/IG/15 established a group of activities to migrate from the pre-operational phase to the operational between the ACC Bogota, Guayaquil and Lima.
6.1 It is proposed that, as a matter of priority, the SAM/IG/15 meeting do the follow-up of AIDC implementation. Accordingly, the AIDC operational implementation working group will hold its first meeting.	11/05/15	15/05/15	RLA/06/901 member States	Additionally the AIDC messages to be used were defined.
<b>7. AIDC operational implementation</b>	<b>18/05/15</b>	<b>31/12/15</b>	Involved States	
7.1 Definition of the parameters of the AIDC database for the to AID operational interconnection between Colombia, Ecuador and Peru	25/05/15	29/05/15	Involved States	<b>Completed.</b>
7.2 Amend letter of operational agreement to include the AIDC for the coordination between the ACC Lima with AAC Bogota, ACC Bogota with ACC Guayaquil and ACC Lima with ACC Guayaquil	15/06/15	31/03/16	Involved States	<b>Valid.</b> Only letter of operational agreement between the ACC Guayaquil and ACC Lima was amendent and signed. (October 2015). Pending final review and sign letter of operational agreement between ACC Lima and ACC Bogota, ACC Bogota and ACC Guayaquil.
7.3 Teleconferences to coordinate and follow-up the migration from the AIDC pre-operational phase to the operational for Colombia, Ecuador and Peru	June 2014	Monthly Tele-conferences at the	Involved States ICAO	<b>Valid.</b> Teleconferences are been carried out on monthly basis since June 2014.

	<b>Start</b>	<b>End</b>	<b>Responsible party</b>	<b>Status</b>
		beginning of each month until end 2016		On 2016 teleconferences were conducted on: 19 January 23 May 19 February 3 June 18 March 6 September
7.4 Complete courses for the ACC Lima and Guayaquil, Bogotá ATS staff as well as staff ARO/AIS	18/05/15	29/02/16	Involved States	<b>Completed.</b>
7.5 Preoperational and operational Implementation of AIDC  Guayaquil ACC - Lima ACC  Bogota ACC - Guayaquil ACC  Lima ACC - Bogota ACC  Lima ACC – Santiago ACC*	18/05/15	31/07/16	States involved	<b>Valid.</b> Letter of operational agreement with corrections on AIDC between ACC Colombia, Ecuador, Panama and Peru were amended (October 2015).  Letter of operational agreement between AAC Lima and Guayaquil with the inclusion of AIDC was signed on 23 October 2015.  Establishing of a pre-operational period completing the ATS staff training.  Operational implementation. AIDC between ACC Lima - ACC Guayaquil in operational phase from August 3, 2015, becoming operative on 31 March 2016.

	<b>Start</b>	<b>End</b>	<b>Responsible party</b>	<b>Status</b>
				<p>The AIDC between the ACC Bogota and the ACC Lima and ACC Guayaquil is in pre-operational phase since May, 2015.</p> <p>* The AIDC operational implementation between the ACC Lima and ACC Santiago has postponed in view of the delay in the modernization of the ACC Santiago automated Center (2017).</p>
<p><b>8. Other AIDC implementations</b></p> <p><b>Bogota ACC - Panama ACC</b>  <b>Ezeiza ACC - Montevideo ACC</b>  <b>Resistencia ACC - Asunción ACC</b>  <b>Curitiba ACC – Resistencia ACC</b>  <b>Iquique ACC – Lima ACC</b>  <b>Cordoba ACC – Iquique ACC</b>  <b>Amazonico ACC – Bogota ACC</b>  <b>Amazonico ACC – Lima ACC</b></p>	18/05/15	31/12/16	States involved	
8.1 Definition of parameters of the AIDC database for the operational interconnection of the AIDC		29/07/16	States involved	<b>Valid</b> Defined for AIDC between: Bogota ACC-Panama ACC and Iquique ACC-Cordoba ACC.
8.2 Amendment of letter of operational agreement to include the AIDC for coordination between ACCs.		31/10/16	States involved	<b>Valid</b>

	<b>Start</b>	<b>End</b>	<b>Responsible party</b>	<b>Status</b>
8.3 Carry out teleconferences for coordination and follow-up to the migration from the AIDC pre-operational to operational fase		Monthly tele-conferences at the beginning of each month until the end of 2016	States involved ICAO	<b>Valid</b> Teleconferences conducted 19 January 23 May 19 February 3 June 18 March 6 September
8.4 Practical courses addressed to the ATS AIS CNS personnel of the ACC involved, interconnection AIDC		30/11/16	States involved OACI	<b>Valid</b> AIDC Course (Panamá 22 -26 June) 2015  AIDC Course (Paraguay 17-21 October 2016).  AIDC Course (Curitiba 10 - 16 October 2016).
8.5 Conduction of AIDC interconnection test between adjacents ACCs		30/11/16	States involved	<b>Valid</b> Successful AIDC interconnection tests between Bogota and Panama. (June 2015).  AIDC tests Iquique ACC and Lima ACC were successfully conducted on December 2015.  AIDC tests Iquique ACC and Cordoba ACC were made in February 2016 with positive results but the ABI message.

	<b>Start</b>	<b>End</b>	<b>Responsible party</b>	<b>Status</b>
				<p>AIDC tests Brazil Peru were conducted in March 2016 with problems with ABI messages at the beginning which were overcome by Atech.</p> <p>AIDC tests Ezeiza ACC and Montevideo ACC (May 2016).</p> <p>AIDC tests Asuncion ACC and Resistencia ACC (October 2016).</p> <p>AIDC tests Curitiba ACC and Resistencia ACC (November 2016).</p> <p>AIDC tests Curitiba ACC and Resistencia ACC (November 2016).</p> <p>AIDC tests Curitiba ACC and Resistencia ACC (November 2016).</p> <p>AIDC tests Bogota AAC and Amazonico ACC (November 2016).</p>

8.6 Implantation of pre-operational and operational AIDC		31/12/16	States involved	<p><b>Valid</b></p> <p>AIDC between Bogota ACC and Panama ACC is in pre-operational phase since October 2015. Operational phase foreseen by the second-half of 2016.</p> <p>AIDC between Ezeiza ACC and Montevideo ACC in pre-operational phase foreseen by first semester 2017.</p> <p>AIDC between Asuncion ACC and Resistencia ACC in pre-operational phase foreseen by the first semester 2017 and operational by second semester 2017.</p> <p>AIDC between Iquique ACC and Lima ACC will be in pre-operational phase on October 2016 and operational on the first semester 2017.</p> <p>AIDC between Iquique ACC and Cordoba ACC will be in pre-operational phase by the first semester 2017 and operational by the second semester 2017.</p>
--	--	----------	-----------------	--

				<p>AIDC between Curitiba ACC and Resistencia ACC will be in pre-operational phase by the first semester 2017.</p> <p>AIDC between Amazonico ACC and Lima ACC will be in pre-operational phase by October 2016 and operational by December 2016.</p> <p>AIDC between Amazonico ACC and Bogota ACC foreseen operational by December 2016.</p> <p>Remaining interconnections foreseen pre-operational by first semester 2017 and operational by the second semester 2017.</p>
<p><b>9. Workshop on implementation of ATM automation, ADS B, and multilateration</b></p>	<p><b>22/09/15</b></p>	<p><b>25/09/15</b></p>	<p>ICAO</p>	<p><b>Concluded</b>                      NAN/CAR/SAM workshop held in Panama (22-25 September 2015). The implementation of inter-regional AIDC interconnections was analysed at the workshop.</p>
<p><b>10. Second meeting of the AIDC operational implementation working group during SAMIG/16</b></p>	<p><b>19/10/15</b></p>	<p><b>23/10/15</b></p>	<p>ICAO</p>	<p><b>Concluded</b></p>
<p>10.1 It is proposed, as a matter of priority, the SAM/IG/16 meeting do the follow-up of AIDC implementation. Accordingly, the second meeting of the AIDC operational implementation</p>	<p><b>19/10/15</b></p>	<p><b>23/10/15</b></p>	<p>ICAO</p>	<p><b>Concluded</b>                      Follow-up was made on the operational implementation</p>

working group will be held.				and programming of activities for operational implementation in 2016.
<b>11. AIDC Implementation meetings</b>	01/01/2017	31/12/2019	Involved States ICAO	<b>Valid</b>
11.1 Implementation of 12 AIDC interconnections at inter-regional level and 9 interconnections distributed as follows: Colombia (3), Ecuador (1), Panama (1) and Venezuela (4).	01/01/2017	31/12/2019	Involved States ICAO	<b>Valid</b>
11.2 Inter-regional AIDC interconnections between SAM and AFI Regions: Argentina (1), Brazil (2), French Guiana (1) and Uruguay (1)	01/01/2017	31/12/2019	Involved States ICAO	<b>Valid</b>
<b>12. Monitoring to the AIDC interconnection implementation</b>	<b>2015</b>	<b>2019</b>	ICAO	
<b>12.1 AIDC Implementation Meeting</b>  ✓ First AIDC Implementation Meeting  ✓ Second AIDC Implementation Meeting  ✓ Third AIDC Implementation Meeting  ✓ Fourth AIDC Implementation Meeting  ✓ Fifth AIDC Implementation Meeting	<b>March 2016</b>	<b>September 2019</b>	ICAO	<b>Valid</b>  AIDC/1 (Lima, Peru, 28-30 March 2016) AIDC/2 (Lima, Peru, 21-23 September 2016) AIDC/3 (Lima, Peru, June 2017) Approved by RCC/10 AIDC/4 (Lima, Peru, June 2018) AIDC/5 (Lima, Peru, September 2019)

## APPENDIX D

**NATIONAL FOCAL POINTS/PUNTOS FOCALES NACIONALES  
IMPLEMENTATION OF INTERCONNECTION OF AUTOMATED SYSTEMS/IMPLANTACIÓN INTERCONEXIÓN SISTEMAS  
AUTOMATIZADOS**

STATE/ ESTADO	ADMINISTRATION/ ADMINISTRACIÓN	NAME/ NOMBRE	POST/ CARGO	TELEPHONE/ TELEFONO	E-MAIL
<b>ARGENTINA</b>	DGCTA	Rubén Silva	Especialista ATM sistemas automatizados		<a href="mailto:rubensilva@hotmail.com">rubensilva@hotmail.com</a>
		Mario Correa	Jefe sistemas automatizados ATS	(54 11) 4317-6015	<a href="mailto:mario_correa@yahoo.com.ar">mario_correa@yahoo.com.ar</a>
		Javier Vittor	Especialista CNS	(54 11) 4480-2362 (54 911) 6894-0692	<a href="mailto:javiervittor@gmail.com">javiervittor@gmail.com</a>
	ANAC	Diego Agüero	Técnico automatización	(54911) 2258-7836 (5411) 5941-3000 Ext.69-128	<a href="mailto:daguero@anac.gob.ar">daguero@anac.gob.ar</a>
<b>BOLIVIA</b>					
<b>BRAZIL/ BRASIL</b>	DECEA	Alexander Santoro	Especialista CNS	(55 21) -2101-6620	<a href="mailto:santoroas@decea.gov.br">santoroas@decea.gov.br</a>
		Murilo Loureiro	Asesor sistemas automatizados	55 (21) 2101-6658	<a href="mailto:murilo.loureiro@gmail.com">murilo.loureiro@gmail.com</a>
<b>COLOMBIA</b>	UAEAC	Harlen Mejía	Jefe de Aeronavegación		<a href="mailto:harlen.mejia@aerocivil.gov.co">harlen.mejia@aerocivil.gov.co</a>
		Mauricio Ferrer	Especialista ATM sistemas automatizados		<a href="mailto:mauricio.ferrer@aerocivil.gov.co">mauricio.ferrer@aerocivil.gov.co</a>
		Pedro Alejandro Velasco	Jefe Grupo de Vigilancia Aeronáutica	(57) 317656-7203	<a href="mailto:pedro.velasco@aerocivil.gov.co">pedro.velasco@aerocivil.gov.co</a>
<b>CHILE</b>	DGAC	Pedro PASTRIAN	Especialista radar y sistemas automatizados	(56 2) 836-4005 (56 2) 644-8345	<a href="mailto:ppastrian@dgac.gob.cl">ppastrian@dgac.gob.cl</a>
		Christian Vergara	Especialista comunicaciones	(56 2) 836-4005 (56 2) 644-8345	<a href="mailto:cvergara@dgac.gob.cl">cvergara@dgac.gob.cl</a>

STATE/ ESTADO	ADMINISTRATION/ ADMINISTRACIÓN	NAME/ NOMBRE	POST/ CARGO	TELEPHONE/ TELEFONO	E-MAIL
		Gustavo Cáceres Moraga	Controlador Tránsito Aéreo Ofc. Operaciones ACCS	(56 2) 91581853 (56 2) 28364018	<a href="mailto:gcaceres@dgac.gob.cl">gcaceres@dgac.gob.cl</a>
ECUADOR	DAC	Raul Avellan	Especialista CNS coordinador sistema AMHS	(593 4) 269-2829 (593 9) 9530-2735	<a href="mailto:raul.avellan@aviacioncivil.gob.ec">raul.avellan@aviacioncivil.gob.ec</a>
		Jorge Zúñiga	Programación FDP y coordinaciones	(593 2) 2604477	<a href="mailto:jorzu40@hotmail.com">jorzu40@hotmail.com</a>
		Eugenio Espinoza	Controlador ACC Guayaquil Radar	(593) 981269823	<a href="mailto:eugenio.espinoza@aviacioncivil.gob.ec">eugenio.espinoza@aviacioncivil.gob.ec</a>
GUYANA					
GUYANA FR./ FRENCH GUIANA	Service de la Navigation Aérienne aux Antilles-Guyane (SNA-AG)	Michel Areno	Head French Guiana ACC	(594) 694455617	<a href="mailto:michel.arena@aviation-civile.gouv.fr">michel.arena@aviation-civile.gouv.fr</a>
PANAMA	Autoridad Aeronáutica Civil (AAC)	Mario Antonio Facey Howard	Especialista radar y sistemas automatizados	(507) 315-9852/65	<a href="mailto:mfacey@ aeronautica.gob.pa">mfacey@ aeronautica.gob.pa</a>
		Gilda Aracelly Espinosa Perez	Supervisora de area y aproximación radar	(507) 3929899	<a href="mailto:gespinosa@ aeronautica.gob.pa">gespinosa@ aeronautica.gob.pa</a>
PARAGUAY	DINAC	David Torres	Jefe de Sección, Encargado del Sistema ATM ARCON210	(595) 9812-31575	<a href="mailto:dr.torres33@gmail.com">dr.torres33@gmail.com</a>
		Diego Ramón Aldana Fernández	Supervisor ACC/APP	(595) 21 645-707	<a href="mailto:diegoaldana@gmail.com">diegoaldana@gmail.com</a>
PERÚ	CORPAC	Johnny Ávila	Jefe equipos centro de control	(511) 230-1000 Anexo:1267	<a href="mailto:javila@corpac.gob.pe">javila@corpac.gob.pe</a>
		Jorge Eduardo Merino Rodríguez	Especialista ATM Controlador de Tránsito Aéreo	(51 1) 230-1000 Ext 1158 (511) 5750886 (Centro de Control Lima) (511) 5750995	<a href="mailto:jmerino@corpac.gob.pe">jmerino@corpac.gob.pe</a> <a href="mailto:jemr69@yahoo.com">jemr69@yahoo.com</a>

STATE/ ESTADO	ADMINISTRATION/ ADMINISTRACIÓN	NAME/ NOMBRE	POST/ CARGO	TELEPHONE/ TELEFONO	E-MAIL
				Mobile: 51 99737407	
		Gino Lago	Especialista ATM Controlador de Tránsito Aéreo	(51 1) 414-1000	<a href="mailto:glago@corpac.gob.pe">glago@corpac.gob.pe</a>
		Raul Anastacio Granda	Supervisor Comunicaciones AMHS-AFTN Área de Comunicaciones Fijas Aeronáuticas	(511) 230-1018	<a href="mailto:ranastacio@corpac.gob.pe">ranastacio@corpac.gob.pe</a>
<b>SURINAM/ SURINAME</b>					
<b>URUGUAY</b>	DINACIA	Antonio Lupacchino	Especialista CNS sistemas automatizados	(598) 2604-0408 Ext.4520	<a href="mailto:alupacch@yahoo.com.ar">alupacch@yahoo.com.ar</a>
		Gustavo Turcatti	Jefe Departamento Operativo de Tránsito Aéreo	(598) 2604-0408 Ext.5111	<a href="mailto:blantur@gmail.com">blantur@gmail.com</a>
<b>VENEZUELA</b>	INAC	Alfredo A. Dávila Alfonzo	Coordinador Área de Trabajo ATS	(58 212) 2774-439	<a href="mailto:a.davila@inac.gob.ve">a.davila@inac.gob.ve</a>
		Francisco Antonio Ortiz	Gestión Operacional ATM		<a href="mailto:f.ortiz@inac.gob.ve">f.ortiz@inac.gob.ve</a>
		Jean Carlos Lozano Garcia	Controlador tránsito aéreo ACC Maiquetía	58 416 7226428	<a href="mailto:jclozgar@hotmail.com">jclozgar@hotmail.com</a>