



ICAO

*International Civil Aviation Organization***Seventh Meeting of the Surveillance Implementation Coordination Group (SURICG/7)**

Video Teleconference, 24 – 27 May 2022

Agenda Item 3: Review Report of DAPs WG/5 Meeting

REVIEW REPORT OF THE FIFTH MEETING OF THE DOWNLINK AIRCRAFT PARAMETERS (DAPs) WORKING GROUP (MODE S DAPs WG/5)

(Presented by the Secretariat)

SUMMARY

This paper presents the report of APAC Regional Workshop on Mode S Implementation and the Fifth Meeting of the Mode S Downlink Aircraft Parameters working group (Mode S DAPs WG/5) held via video Tele-conference from 22 to 25 March 2022, and follow up actions, for review and action.

1. INTRODUCTION

1.1 The APAC Regional Workshop on Mode S Implementation and the Fifth Meeting of the Mode S Downlink Aircraft Parameters Working Group (Mode S DAPs WG/5) were held via Video Tele-Conference (VTC) on 22 March 2022 and from 23 to 25 March 2022 respectively. The Workshop and the Meeting were attended by **114** participants from **18** States/Administration and **2** International Organizations. The meeting report, working papers, information papers, workshop presentation, Q&A, and other resources can be accessed at:

<https://www.icao.int/APAC/Meetings/Pages/2022-Mode-S-DAPs-WG5.aspx>

2. DISCUSSION*APAC Regional Workshop on Mode S Implementation*

2.1. The Workshop organized in conjunction with the Mode S DAPs WG/5 meeting was moderated by Mr Ho Wee Sin, co-chair of Mode S DAPs WG, and presented by Mr Chen Yang (Isaac), an experienced radar engineer who was recommended by the Air Traffic Management Bureau (ATMB) of Civil Aviation Administration of China (CAAC). Mr Robert Witzen supported the presentation.

2.2. The Workshop first discussed various topics under Mode S operations, including the detailed explanation of the dialogue between Mode S Interrogator and Transponder, to familiarise the participants on the working principles. The Workshop introduced the background and the use of II & SI code, methods and protocols of acquisition and lockout, mode interlace pattern, the optimal interrogation sequence, as well as the power and time constraint of the interrogator. All these details contributed to the basic concept of Mode S operations. Various operational requirements of SSR Mode S Elementary Surveillance (ELS) and Enhanced Surveillance (EHS), Comm-B Data Selector (BDS) register introduction and a sharing on the optimal register extraction. Basic electrical specifications, interrogation acceptance & lockout protocols of Mode S Transponders were discussed. The Workshop

also advised the knowhow of flight inspection to a Mode S Radar, and the introduction of APAC's proposed modifications to Appendices H and J of Doc 9924 to facilitate the implementation of Mode S.

Outcome of Relevant Meetings on Surveillance- Sec (WP/02)

2.3. This paper summarized relevant information and updates with the highlight on the outcomes of Mode S DAPs WG/4 reviewed by SURICG/6 and adopted in CNS SG/25 and by APANPIRG/32.

2.4. The paper also reviewed various topics discussed in Mode S DAPs WG/4 including the endorsed Conclusions on Interrogator Code (IC) Planning and Coordination (Conclusion APANPIRG/32/8), Transition to II and SI Mixed Code Operation (Conclusion APANPIRG/32/9), APAC Regional Roadmap for Mode S Implementation (Conclusion APANPIRG/32/10) and Actions taken on Regional Supplement to ASTERIX Interface Control Document (ICD) (Conclusion CNS SG/25/11).

Amendment of Appendix H and Appendix J of Doc 9924 - CHN, SGP & Sec (WP/05)

2.5. This paper introduced the current proposals for amending the Aeronautical Surveillance Manual (Doc. 9924) Appendix H and J. These amendments in Appendix H will clarify and elaborate on the acquisition and detection of Mode S II-only (non-SI capable) transponders by Mode S II/SI capable interrogators as well as the acquisition and detection of Mode S II/SI capable transponders by Mode S II-only interrogators as currently described in paragraphs 1.2.5 – 1.2.11 of Appendix H, and introduce the planning criteria in Appendix J for co-existence of II and SI codes under the environment where there are non-SI capable transponders still in operations.

2.6. The proposed amendment was given in full in Annex A to this paper, which is being deliberated at the Surveillance Panel and it has been endorsed by the Technical Sub-group in February 2022. It is scheduled to be discussed at the Aeronautical Surveillance Working Group in April 2022 and October 2022 before formal adoption. The meeting was guided through some important highlights in the updated context.

2.7. Japan suggested to align the use of term "the minimum triggering level (MTL)" in Appendix H paragraph 1.1.4 to be consistent with RTCA DO-181 and other standard materials. In addition, duplicated paragraph number 8.2.5.4 in Appendix J was observed. The suggestions / observations were noted and the draft would be reviewed for further deliberation. Secretariat congratulated the achievements contributed from the ad-hoc group under this Working Group.

Update on Interregional IC Coordination – Sec (IP/05)

2.8. This paper summarized the latest updates about the procedures on SSR IC code interregional coordination from a virtual meeting organized for technical officer CNS, ANB, and all ICAO Regional Officers CNS on 20 January 2022 to review and understand procedures established for SSR IC code assignment and Inter-regional coordination mechanism.

2.9. The meeting on 20 January 2022 reviewed a presentation summarized the relevant documents for SSR IC code assignment and inter-regional coordination mechanism including excerpts from Annex 10 Volume 4 and Doc. 9924 in Appendix A to the paper; an example of coordination conducted by APAC region in Appendix B to the paper; a presentation on the coordination using SSR Module of the Frequency Finder tool and its future improvements in Appendix C to the paper; and a secretariat paper on International and inter-regional coordination of Mode S II and SI codes, and the

outcome of this discussion was summarized into a draft procedure in Appendix D to the paper. Considering the length of the materials covered in the paper, the meeting was invited to contact ICAO Secretariat for enquiries.

Guidance Material for Assignment of Interrogator Codes (IC) for MLAT and ADS-B - Singapore (IP/12)

2.10. During the Mode S DAPs WG/2, it was discussed whether interrogators that come with ADS-B need to be assigned with a distinct IC. Current practices suggested that II=0 can be used. However, the existing provisions in ICAO documents are not clear to the reader and can be confusing. The Surveillance Panel Aeronautical Surveillance Working Group is working on revising the text in the SARPS and guidance material. The paper provided the updates on the proposed amendments to Annex 10 Vol IV and ICAO Doc 9924 Appendix M which have been endorsed by the Technical Sub-group in Feb 2022. It will be further discussed at the Aeronautical Surveillance Working Group in Apr 2022 and subsequent meetings before its formal adoption.

Reservation of IC Codes for Research and Military – China, Singapore and Sec (WP/06)

2.11. This paper discusses the feasibility for Asia Pacific Region to adopt the practice of reserving Interrogator Identification (II) 14 for testing, research, and development of Mode S Radar and II 15 for military deployable and shipborne radar.

2.12. In Europe and Australia, allocation of II 14 and matching SIs is provided for time-limited testing and research activities by States without the need to coordinate unique code allocations. II 15 and matching SIs are delegated to military agencies for allocation and management for deployable radars including shipborne systems, which the practice removes the coordination responsibility from the civil aviation agencies. Fixed military radars should still be coordinated with the civil aviation authority with II codes in the range 1 to 13 and matching SI codes allocated. Radars operating with IIs 14 and 15, or their matching SIs cannot claim protection from other radars also operating with matching IIs and SIs respectively. States in line with the practice of other regions will help the coordination efforts among other Regions.

2.13. To review the current situation in APAC, an initial study was conducted and showed that not all current Mode S radars that are on II 14 and II 15 can be re-allocated to other codes in the range 1-13. There will not be sufficient codes within the range 1 – 13 to ensure code uniqueness. Considering States are modernising with Mode S radars, APAC is in the direction of migrating from II to SI code to create capacity for more Mode S radars, the Draft Conclusion proposed in the paper was discussed, and the meeting suggested to defer and not to endorse as Draft Conclusion in this meeting, and formulated a future action instead, which was referred as ACTION ITEM 10 to this Working Group as recorded in Appendix C to this report.

2.14. Australia expressed that while it is accepting of not reserving II 14 for test and evaluation purposes, it would seek to continue the allocation of II 15 to military agencies for its own ordination and no need to consider II 15 codes through the Regional Office process. Chair commented that as territorial area of Australia is large and is further apart from other States, the chance of conflict due to the use of II code 15 was minimal. Such assignment is to be carried out in conformance with the procedures established by the State that will ensure no degradation of safety for civil aviation.

Options for Vacating the SSR Mode S II Codes 14 and 15 in the APAC Region – Sec (IP/04)

2.15. This paper reviewed a detailed analysis of the feasibility to replace the existing II codes 14 and 15 with the other codes within the range 1 to 13, which showed the possibilities for reassigning IIs 14 and 15 to IIs 1-13, by using SSR II code module in Frequency Finder tool. Details of analyses are provided in the paper.

2.16. Outcome of the study showed that it was not possible to replace all the existing Mode S II code 15 in the APAC Region, and in geographical area around Japan and Malaysia, the option of using alternative II codes is very limited and the alternative codes may be needed for additional Mode S II code assignment. For Mode S II Code 14 there were three (out of 15) current assignments to SSR Mode S II code 14 that have no alternative II codes that are fully compatible with the planning criteria for SSR Mode S II codes.

2.17. India enquired if there were any criteria for selecting a particular II code over other alternative codes available. Chair informed that in practice, certain II codes were less used than others, on top of the intentional reserve for II codes 14 and/or 15 determined by States. Considering the need for migrating from II to SI codes, vacated II codes could be redeployed to II only radars. In theory, II code can be assigned if no one is using, subject to the implementation plan of States. Secretariat supplemented that available II codes were searched and generated by computer systems developed to estimate the suitability of available codes, and ICAO APAC Regional Office would select the best option and advise to requesting State for their consideration.

2.18. Chair asked the management of II codes for States with large terrestrial coverage by ICAO APAC Regional Office. Secretariat mentioned that States may consider their radar coordinates as sensitive, thus the information was not fully shared to the ICAO APAC Regional Office and this could be a challenge for ICAO APAC Regional Office to provide effective evaluation to the actual use of II codes. States were invited to provide necessary radar information to ICAO APAC Regional Office for II/SI code coordination.

Update on Mode S IC Code Module in Frequency Finder by Secretariat – Sec (WP/07)

2.19. This paper presented the latest work, enhancements and functionalities brought to the SSR module of the Frequency Finder tool to assist ICAO Regional Offices and States to manage and coordinate SSR Mode S II/SI codes. The Frequency Finder Tool included a module for SSR Mode S Interrogator Identifier (II) code assignments that was introduced about ten years ago. The need for APAC Region to introduce SSR Mode S Surveillance Identifier (SI) code was identified in previous meetings, relevant change proposals to DOC 9924 are being reviewed in Surveillance Panel and these changes will be reflected in the Mode S IC Code Module to assess the compatibility of both Mode S II and SI Codes. The updated Frequency Finder tool is being tested by ICAO Head Quarters and APAC Regional Office and will be released in second or third quarter of 2022 as expected. Standalone version of the Mode S IC Code Module will also be available for those who look after SSR Codes.

2.20. A demo was presented by Mr Robert Witzen in the meeting to show the interface and functions for updated Mode S IC Code Module. The meeting was invited to make extensive usage of the updated module, and provide feedback such as usage, suggestions, bugs and recommendations on the updated Frequency Finder tool.

An Abnormal Problem of CPR Decoding caused by the Incorrect Air-ground State of an Aircraft – China (IP/06)

2.21. This paper introduced an abnormal Compact Position Reporting (CPR) decoding problem caused by the airborne aircraft transmitting the Surface Position state, and proposed the corresponding solution.

2.22. CPR technique was categorised into locally and globally unambiguous decoding. By encoding in two different ways which are called even format and odd format, with each occupying fifty percent of the time respectively. Upon reception of both types within a short period, the receiving system can unambiguously determine the location of the aircraft. Globally unambiguous decoding is based upon the receipt of an even and an odd encoded position squitter, and local decoding technique is based on a single position report, either even or odd encoding. Once the globally unambiguous position is determined, the emitter-centred local decoding technique is used for subsequent decoding based on a single position report, either even or odd encoding. Both decoding methods were introduced in depth in the paper.

2.23. A case of ADS-B target position jumped was analysed by decoding the DF17 message received, and concluded the source of error was due to an airborne aircraft mistakenly transmitted a Surface Position state message by comparing different fields in various messages. Optimizing methods including initialisation state CPR check and change local-decode method, with the logic of CPR message processing, were introduced in depth.

2.24. India reported a suspected case of ADS-B incorrect target position received from space-based ADS-B and wonder if the tool mentioned in the paper could help detect such situation, and China informed that more information has to be gathered for analysis. India would provide necessary information to China through ICAO Secretariat. Confirmed the ground stations were domestically produced, Chair commented that such enhanced algorithm in detecting the conflicted content in different messages might not simply be applicable to ground stations in other countries as the algorithm would need an OEM to update from time to time. China confirmed an enquiry of the aircraft started transmitting surface positions after sending the airborne positions, instead of from the beginning.

Mode S Interrogator Codes Allocation and Conflict Analyses – China (IP/07)

2.25. This paper shared the information about the Mode S II codes allocation principles in China and the related conflicts with neighbouring countries.

2.26. There are 140 secondary surveillance radars in service in China, with 78 of them are Mode S radars and have been allocated II codes from 1-13. II code 14 and 15 are reserved for test and military respectively. Without the usage of SI codes, II codes are a shortage in the eastern coastal areas in China. Therefore, interrogation strategies of all-call lockout override protocol, roll-call non-lockout, or intermittent lockout commands have been set to radars with overlapping coverage. To solve the II codes shortage issues in China effectively, the following were being carried out, which were discussed in the paper in detail:

- Centralized allocation of II codes in China;
- Analysing the conflict of II codes allocation in China; and
- Analysing the conflict of II codes allocation between China and neighbouring countries.

2.27. The paper recommended the release of II code 14 for civilian radars and reserve II code 15 for both testing and military purposes. Chair advised that this recommendation follows Australia's recommendation in the last meeting.

2.28. Republic of Korea, one of the neighbouring countries mentioned in this paper, enquired if there was any aircraft detection lost in the overlapped region of detection. No aircraft detection loss

was reported by China in the overlapped region. China agreed to share further information on the enquiry to ROK for their analysis. China actively supports ICAO APAC as the center for the distribution and coordination of II codes in the APAC region. China will also further confirm the issue of II code conflicts with neighbouring countries and apply to ICAO APAC for coordination.

2.29. Noticing the use of lockout override in the reported analysis, Chair enquired the purpose for applying all-call lockout override and whether this was a long term planning, or a short term measure until SI codes were implemented. China advised that not all aircraft equipped with SI transponder capability and hence the use of II code would be continued.

Progress on the Trials of Mode S Surveillance Co-ordination Network in China (IP/08)

2.30. This paper informed about the implementation background and progress of the trials on surveillance co-ordination network (SCN) of the Mode S secondary radar in China. Based on the operation results of SCN trials, China plans to formulate guidelines to regulate the SCN structure, operation mode, and corresponding interface.

2.31. The trial of SCN technology used HDLC, UDP/IP and TCP/IP protocols for data links to implement surveillance co-ordination functions (SCF) such as target information sharing, track fusion, and smoothing among multiple radars, thereby improving the quality of target detection in a specific area. The implementation of SCN could bring the advantages in following aspects:

- Solve problem of insufficient II code by enabling Mode S radars in same cluster to share a same II code thus optimize the use of II code;
- Alleviate 1090MHz spectrum occupancy by, in theory, reducing the interrogations and replies of Mode S radars in overlapping area and thus improving surveillance performance; and
- Overcome defects by single radar source in certain scenarios.

2.32. The Mode S SCN trials in China are carried out in three stages:

- The first stage: use radars of the same radar manufacturer to conduct cluster trials.
- The second stage: use radars of different radar manufacturers to conduct cluster trials.
- The third stage: according to the trials results and our evaluation, CAAC will formulate a formal technical specification for Mode S SCN implementation in China.

2.33. The paper introduced the timeline for the trial, which expected to complete by end of 2022. It was recognised that only very few States in APAC Region has the need to implement such SCN for radar clustering, and the stability of network connection was a critical infrastructure to such network. The meeting was informed that the trial included the scenarios of network connection loss, and the status and stability of SCN was monitored via NMP, network management protocol.

Upper Air Wind Speed Estimation based on Mode S SSR DAPs – China (IP/09)

2.34. This paper introduced the research for upper air wind speed estimation based on Mode S SSR DAPs and discussed issue of airborne magnetic deviation from DAPs. Wind speed estimation includes aircraft observed wind speed estimation and its verification, which were completed, and the regional wind speed estimation is in progress, with further results verification required. The paper explained the estimation progress and data used in detail. Based on the method of wind speed estimation, which can be referred to as [IP11 JAP Utilization of Mode S DAPs Data for Weather Forecast in DAPs WG/3](#), a few filters and corrections were made.

2.35. For regional wind speed estimation, the estimated wind speed of different aircraft has the problem of uneven spatial and temporal distribution, which is hard to meet the need of trajectory prediction. Method to estimate regional wind speed were studied to obtain quasi-real-time raster regional wind speed data. The particle swarm optimization (PSO) algorithm is used to estimate regional wind speed, which can quickly estimate and predict regional wind speed data, and relevant optimization and verification are still in progress. The basic mechanism were introduced in the paper in depth.

2.36. Observing the data of aircrafts on the runway, certain error was observed between the downlink magnetic heading and the real magnetic heading of the aircraft, known as magnetic deviation. The downlink magnetic heading data of one day-long aircraft taxiing on the runway were collected for analysis, and it was found that the data distribution ranged from 193 to 200 degrees. Based on the magnetic heading of the runway and aircraft downlink magnetic heading, the aircraft's compass correction table was generated by using ellipse fitting method, and the magnetic deviation of aircraft could be corrected from using the table given in the paper. A "whitelist" was created based on the data of aircraft with highly fitting degree of compass correction. Only DAPs of aircrafts in the whitelist were used for wind speed estimation.

Suggestions of Performance Parameters and Benchmarking of Radar System for APAC Region - China (WP/10)

2.37. This paper presented a brief overview of the radar performance parameters included in the [Guidance Material on Surveillance Technology Comparison \(GMST\) version 1 published in 2007](#) and Doc 8071 Vol 3, and proposed some suggestions for the related study of the radar performance parameters study group, per SURICG/6 ACTION ITEM 6-4.

2.38. The paper reviewed the contents in GMST and Doc 8071 respectively. In GMST, the general surveillance system performance parameters, issues to be considered and recommended performance parameters are summarized for review in the paper. For Doc 8071 Vol 3 Version 2, the general radar system performance parameters, data used to evaluate radar system and typical overall performance parameters for primary, sliding window SSR and monopulse SSR Systems were reviewed in detail.

2.39. The paper further reviewed the radar data provided and categorised into two categories, namely the calculated data and forwarded data. Multiple sources of data used for radar performance analysis, including opportunity traffic from real-time environment that reflect the most comprehensive overall radar performance, dedicated flight trail to verify the radar performance limit like the coverage boundary, simulated/recorded data to evaluate the range and azimuth systematic error and re-verify dedicated issues, and finally the BITE and real-time quality control (RTQC) facilities of the system itself to analyse the radar operational performance.

2.40. The paper recommended the minimal radar performance parameter set to include:

- probability of detection (PD)
- probability of target missing
- probability of false target
- horizontal error (RMS)
- processing delay
- probability of false Mode A/Mode C
- aircraft identification error
- vertical rate error
- speed vector error

- special code error
- PSR/SSR combination rate

2.41. The paper further recommended to study the radar performance parameters based on the GMST and Doc 8071 Vol3, and update the definition of relevant parameters and analyse methods in the GMST, develop corresponding standard software for the test and analysis of the above parameters according to the research results, which can be later used for specific test and analysis work in ICAO APAC region.

2.42. With the excellent paper presented, Chair suggested China to consider taking lead in the ad-hoc group for responding to next SURICG/7 meeting. New Zealand suggested to consider referring to EUROCONTROL Specification for ATM Surveillance System Performance (Volume 1) Edition 1.1, issued September 2015, while ROK commented that this EUROCONTROL document could be too complex to refer to and it lacked the necessary measurement on performance.

SI Operation Plan at Incheon Airport – Republic of Korea (IP/03)

2.43. This paper reported the future plan to adapt Mode S SI operation at the Incheon airport to expand Mode S IC availability due to the increase of Mode S radar operation within the region, thus the difficulties to avoid a radar coverage overlap with II(0~15) code only. The Incheon airport already reported that the target detection performance of SI code was same with II code for 15 days of the test period in 2021. This paper also provided update information about the SI operation at Incheon airport, including a summary of SI operation test results from DAPS WG/4 IP/07.

2.44. Shinbul_B radar was configured to use SI code 34 for 15-day testing. Detection of Mode S target were normal and no detection degradation at SI operation. Analysis from the testing showed that the SI flag (Data Item I048/320) does not give us relevant information about SI/II capability of a transponder. The paper suggested that SI flag must not be used to decide the capability of SI/II at transponders. The radar issues lock-out command to SI capable transponder leaving non-SI capable transponder to reply to all-calls. Incheon airport thinks that the II/SI operation is not practically important based on the analysis result of last year. The radar at SI operation well communicated with the old versions of transponder at ROK air force. Incheon airport is planning to install a third PSR/MSSR by 2023, which will use SI code as all II code already allocated in Republic of Korea.

2.45. Upon an enquiry of clarifying the meaning of the sentence “...II/SI operation is not practically important based on the analysis result of last year”, ROK explained that based on their analysis, all aircraft were detected and they concluded from the 15-day trial that SI operations were safe. However, considering a reduced number and types of aircraft being flown during the COVID-19 pandemic, a more thorough test could better warrant the performance of SI operations. ROK agreed for the need of a continued trial after pandemic, and they agreed to report in next meeting for their future updates on their trial. The meeting agreed that such trial of SI operation should consider the environmental factors, air traffic volume and aircraft transponder capabilities.

A GPS Interference Identification Method based on ADS-B Data – China (IP/10)

2.46. This paper introduced a GPS interference source identification and screening method in civil aviation operations. Using the changes of aircraft ADS-B report data, combined with the change rule of historical data when GPS was interfered and the principle of satellite navigation signal, this paper presented the construction of an index of GPS interference, which can check and locate interference area and time sensitively.

2.47. By providing two examples of GPS signal interference and illustrating the change pattern in ADS-B data, it was shown that when NIC index changes due to GPS interference, ground speed and position information would also change. If only NIC changed but other indicators do not, GPS interference did not occur in most cases.

2.48. A request of clarification was made on the distance between the sampled “squares” shown in the paper. China agreed to provide further detail via ICAO Secretariat. In addition, such analysis of GPS signal could be applicable to other States as the method introduced analyses ADS-B report data.

An Evaluation Example of a Non-Cooperative Method for DAPS Data Recognition – Japan (IP/11)

2.49. This paper introduced an evaluation result of a non-cooperative DAPs data recognition and determination method, which may enable DAPs data interception and avoiding BDS SWAP phenomenon. DAPs data is obtained by transmitting a Mode S interrogation and receiving the reply. In the interrogation signal, the Comm-B Data Selector (BDS) code is included to specify the requested data type, but the BDS code is not included in the reply. Receive-only equipment or third-party equipment cannot recognize the DAPs data, even received signals may contain a DAPs reply. With the possibility for BDS swap were also reported in previous DAPs WG meetings, a candidate solution was proposed in SURICG/6 via IP/19 by China, and ENRI evaluated the basic mechanism of the method using measurement data from our experimental SSR.

2.50. In reviewing the solution, The BDS code in a reply is estimated by examining agreement with the standardized message format. For example, a status bit must be set to zero when no information is present in the data block. Some bits are reserved, which must be zero at all times. In addition, some values such as the Mach number must be within the physical boundaries. It is noted that the original method including identification of BDS 50 and 60 by comparing with ADS-B was not conducted in the evaluation. Further improvements such as adding a new physical boundary were made in our evaluation.

2.51. To evaluate the method, an experimental Mode S SSR was set up in ENRI campus in Tokyo. BDS was estimated by using only the reply data, and the estimated result was compared with the correct BDS known from the interrogation data. From the evaluation result detailed in the paper, it was observed that good performance of high success (estimated BDS agreed with the transmitted BDS) on BDS 20, 40, 50 and 60, showing the potential of the proposed method. Future evaluation includes other BDS such as 10, 17, 30 and performance improvement.

2.52. The meeting identified that this evaluation exercise from one State independently verified the study and model done by other States, which was an example of a great collaboration. Japan clarified that the airborne position was obtained via BDS registers in ADS-B message, and further explained that a relatively higher proportion of “Unknown” data was due to direct application of the model proposed by China in IP/19 of SURICG/6.

Management of 1030/1090MHz Utilization - Singapore (IP/02)

2.53. The utilization of the 1030/1090 MHz frequencies has greatly increased in certain areas of the world. If no action is taken, the situation will reach an unacceptable level that will result in harmful corruption or loss of information to the aeronautical surveillance and collision avoidance systems. The total or partial loss of this data will affect the ATM systems and aircraft to-aircraft systems resulting in an increase in the probability of mid-air collisions, disruption to Air Traffic Services, and a reduction in airspace efficiency.

2.54. There are several applications currently competing for channel time on the 1030/1090 MHz frequencies. It must be ensured that the spectrum capacity is being utilized in the most efficient way to preserve the performance of current systems and to consider future applications that require an increase in capacity.

2.55. The Surveillance Panel therefore established the Surveillance Spectrum Focus Team (SSFT) in September 2019 to look into the overall issue of 1030/1090 MHz utilization, including the impact of evolving systems that will potentially share the 1030/1090 MHz link (e.g. RPAS, new ACAS versions, military IFF, Electronic Conspicuity devices for General Aviation) contributing to the spectrum load. It also covers examining techniques and capabilities that could be considered to reduce 1030/1090 MHz congestion. The SSFT will develop specific solutions, which can be transferred into Proposals for Amendment for Annex 10 Volume IV or change proposals for ICAO Manuals.

2.56. A list of identified issues related to 1030/1090 MHz spectrum load and possible mitigations is provided in Annex A to the paper. It also contains information to affected ICAO documents and specific aspects like regulations and already available standards. All this material is considered as a basis to formulate appropriate text for ICAO SARPs and guidance material. Annex A is a “living document” and will be continuously updated to provide a comprehensive database.

2.57. States are urged to follow the guidance and SARPs and guidance materials produced to keep the frequency utilization healthy.

Roadmap on Mode S Implementation for APAC Region - Sec (WP/08)

2.58. This paper summarised the history of the Roadmap on Mode S implementation for APAC Region and proposed the future work on it for information and attention by the meeting. Being one of the key deliverables since established, this Working Group has continued its effort and the Roadmap was adopted as **Conclusion APANPIRG/32/10 (CNS SG/25/09) - The APAC Regional Roadmap for Mode S Implementation**. The adopted Roadmap was circulated through State Letter with **ref:** T 8/5.11-AP200/21 (CNS), **Subject:** *Mode S Implementation in APAC Region*, dated 22 December 2021. The meeting was informed that the Roadmap is a regional planning reference to provide certainty to stakeholders in near term, while as a living document which is subject to change with the revision of APAC Surveillance Strategy and the new relevant outcome from Assembly 41st Session.

Planning Criteria for II/SI Code Assignment - Sec (WP/09)

2.59. This paper presented the planning criteria for the coordination and planning of SSR Mode S II/SI codes, which was in line with the modifications to the Aeronautical Surveillance Manual (Doc. 9924) which was coordinated by the APAC Team and approved by the Technical Sub Group of the Surveillance Panel (SP/TSG). The revised Doc. 9924 was presented in WP/05 in this meeting.

2.60. The paper introduced the definitions of Designated Operational Coverage (DOC), Designated Operational Range (DOR) / Designated Operational Height (DOH), and the definitions from Annex 10 and Doc. 9924 of the Mode S interrogator being II only capable; II/SI capable and supporting II/SI operations; and II/SI capable and not supporting II/SI operations. Initial Mode S II/SI code assignment planning is based on the need to accommodate transponders, whether they are Mode S II-only capable or they are Mode S II/SI capable; both are operating in the same airspace until a mandate forces the sole use of Mode S II/SI transponders.

2.61. To enable the coordination of Mode S II/SI code assignments, States need to provide whether the interrogator is Mode S II only capable or Mode S II/SI capable; when operating with SI codes, supporting II/SI operations or not; and the DOR. The paper further introduced in depth the consideration of II/SI Code assignment planning criteria under different combinations of these criteria, which are further summarized in the table in Appendix A to the paper for ease of reference for the planning of Mode S II/SI code by States.

2.62. The meeting thanked Mr Robert Witzen for his dedicated effort in summarising all the necessary requirements for consideration by States, not all listed in Doc 9924, into this concise and precise paper.

Updates to the Mode S DAPs Implementation and Operations Guidance Document – China (WP/11)

2.63. The paper proposed the revised draft of Edition 4.0 of the Mode S DAPs Implementation and Operations Guidance Document, developed based on the adopted edition 3.0. The revised draft supplemented the guidance material of ADS-B DAPs, including the following:

- Introduce ADS-B DAPs and their benefits in section 1.2
- Describe ADS-B DAPs data and the differences between Mode S SSR DAPs and ADS-B DAPs in section 4
- Supplement the mandate of implementing ADS-B DAPs in section 7.1, and the Mode S extended squitter transponder capability to broadcast ADS-B DAPs in section 7.2
- Add a new section 7.4 to describe ADS-B DAPs broadcast by Mode S extended squitter
- Insert the application of ADS-B DAPs in the ATM automation system in section 7.5
- Give one example of ADS-B DAPs application in section 9

2.64. Other amendments included the revision of the description of the use of Mode S DAPs data for the weather forecast in section 9.3 following Japan’s comments, addition of a new appendix about guidance on measurement of 1030/1090 MHz usage according to Singapore’s proposal in DAPs WG/4.

2.65. Upon review and discussion, the meeting endorsed the updates to the IGD and subsequently endorsed the following Draft Conclusion for further consideration by SURICG/7 and CNS SG/26:

Draft Conclusion DAPs WG/5/1: Mode S DAPs IGD 4.0	
What: The Mode S DAPs Implementation and Operation Guidance Document Edition 4.0 provided in Appendix A to this paper be adopted	Expected impact: <input type="checkbox"/> Political / Global <input type="checkbox"/> Inter-regional <input type="checkbox"/> Economic <input type="checkbox"/> Environmental <input checked="" type="checkbox"/> Ops/Technical
Why: The revised draft includes ADS-B DAPs and adds guidance on measurement of 1030/1090 MHz usage.	Follow-up: <input type="checkbox"/> Required from States
When: 19-Aug-22	Status: Draft to be adopted by Subgroup
Who: <input type="checkbox"/> Sub groups <input type="checkbox"/> APAC States <input type="checkbox"/> ICAO APAC RO <input type="checkbox"/> ICAO HQ <input type="checkbox"/> Other: XXXX	

2.66. The meeting appreciated the effort to the comprehensive updates to cover various areas of the Document from all the contributors.

2.67. Indonesia raised an enquiry on how transponder DO260 (i.e. Version 0) handle emergency code as there is no squawk number or mode A code on first generation extended squitter. China explained that there is no emergency code in Version 0 but there are in Versions 1 and 2 in specific registers, or the emergency status could be obtained as Mode A in Version 2. New Zealand further informed that there is status message in ADS-B which states emergency or general, but not the type of emergency and there was no Mode A code for showing 7500, 7600 and 7700. Chair shared his experience that some ADS-B ground stations installed nearby Mode S radars may obtain the replies from aircraft and combine the information to generate ADS-B message that contains Mode A. New Zealand supplemented that this feature introduced by Chair were provider specific.

Review of Terms of Reference – China and Singapore (WP/03)

2.68. During the SURICG/6, it was suggested that DAPs Working Group be renamed as Mode S Radar and DAPs, and its Terms of Reference (ToR) be amended to better reflect the current work scope that covers not only DAPs but also Mode S radars. As such, the meeting reviewed the proposal of revised ToR attached in the paper, and adopted the following Draft Decision for consideration by SURICG/7. The revised ToR is at **Appendix B** to this paper.

Draft Decision DAPs WG/5/2: Revised ToR of the Mode S Radar and DAPs Working Group	
That, the Revised Terms of Reference of the Mode S Radar and DAPs Working Group provided in Appendix B to this paper be adopted.	Expected impact: <input type="checkbox"/> Political /Global <input type="checkbox"/> Inter-regional <input type="checkbox"/> Economic <input type="checkbox"/> Environmental <input checked="" type="checkbox"/> Ops/Technical
Why: SURICG/6 suggested that DAPs Working Group be renamed, and its Terms of Reference be amended to better reflect the current work scope that covers not only DAPs but also Mode S radars.	Follow-up: <input type="checkbox"/> Required from States
When: 19-Aug-22	Status: Draft to be adopted by Sub-Group
Who: <input checked="" type="checkbox"/> Sub groups <input type="checkbox"/> APAC States <input type="checkbox"/> ICAO APAC RO <input type="checkbox"/> ICAO HQ <input type="checkbox"/> APANPIRG <input checked="" type="checkbox"/> Other: SURICG	

2.69. Hong Kong China expressed their support to the update of the ToR. In addition, New Zealand commented that whether the use of the term “Radar”/”radar” to be replaced by “Surveillance”/”surveillance”, considering New Zealand have launched their use of Mode S MLAT, which should be covered under this Working Group, and the use of “Surveillance”/”surveillance” over “Radar”/”radar” is consistent with most other ICAO documents. Chair expressed his concern that replacing “Radar”/”radar” to “Surveillance”/”surveillance” might push the ToR of this working group to overlap much with the ToR of SURICG. Considering so, Secretariat suggested to put the issue to SURICG/7 for discussion.

Review of Action List - Sec (WP/04)

2.70. The Action Items List updated by Mode S DAPs WG/5 is provided in Appendix C to this paper for information. Per ACTION ITEM 2, the updated Mode S DAPs Implementation Status table for APAC region is provided in Appendix D to this paper. India proposed two additional

parameters to track in the Table, namely the use of Conspicuity Code (Mode A 1000) in the Region and the percentage of Mode S-enabled airspace in the Region. Considering the complexity to share between ATM Automation System Task Force and this Working Group, the meeting agreed that further discussion would be required after Mode S DAPs WG/5 meeting.

3. ACTION BY THE MEETING

3.1 The meeting is invited to:

- a) note and review the information contained in this paper;
- b) consider and endorse the Draft Conclusion in section 2.65;
- c) consider and adopt the Draft Decision in section 2.68;
- d) review and address the discussion in section 2.69; and
- e) discuss any relevant matters as appropriate.



**INTERNATIONAL CIVIL AVIATION ORGANIZATION
ASIA AND PACIFIC OFFICE**

**MODE S DOWNLINK AIRCRAFT PARAMETERS IMPLEMENTATION
AND OPERATIONS GUIDANCE DOCUMENT**

Edition 4.0 - March 2022

Intentionally left blank

PREFACE

This publication is one of the deliverables of the Mode S DAPs WG according to the Terms of Reference (TOR). It aims at providing guidance materials to States and airspace users on the use of Mode S DAPs in the Asia and Pacific Regions from both operational and technical perspectives. A working team was established to develop the contents, and China has volunteered to take lead on coordinating and consolidating inputs from members of the working team.

During Mode S DAPs WG/1 held in March 2018, the meeting considered that further development work is required before the initial draft (Edition 0.1) proposed by China and Hong Kong China becomes ready for approval. Then the working team began to develop the contents of the guidance document, China organized two internal conferences and ICAO APAC office organized a web conference for reviewing the contents. Based on numerous rounds of review and comments with joint efforts from the working team, China has revised the draft into five previous versions. Finally, Edition 1.0 was submitted for endorsement after Mode S DAPs WG/2, and published in the CNS SG/23. China revised the document and circulated it to the members of the Working Group for comments. Then Edition 2.0 was released in 2020, during CNS SG/24. The latest version (Edition 3.0) was adopted by CNS SG/25 in 2021. This version includes information related to ADS-B DAPs, and the revised draft is prepared and proposed to be endorsed by Mode S DAPs WG/5.

The support from ICAO APAC Office and contributions from the following volunteer State/Administration and industry partner in preparing the guidance material is acknowledged and highly appreciated:

- Air Traffic Management Bureau of CAAC, China
- The Second Research Institute of CAAC, China
- Hong Kong Civil Aviation Department, China
- Civil Aviation Authority of Singapore
- Japan Civil Aviation Bureau
- Electronic Navigation Research Institute, Japan
- Airways, New Zealand
- Airservices, Australia

TABLE OF CONTENTS

1. INTRODUCTION	7
1.1 PURPOSE	7
1.2 BACKGROUND	7
1.2.1 <i>Mode S and DAPs</i>	7
1.2.2 <i>Benefit of Mode S and Use of DAPs</i>	8
1.3 ARRANGEMENT OF DAPS IGD	9
1.4 DOCUMENT HISTORY AND MANAGEMENT	9
1.5 COPIES	9
1.6 CHANGES TO DAPS IGD	9
1.7 EDITING CONVENTIONS	9
1.8 DAPS IGD REQUEST FOR CHANGE FORM	11
1.9 AMENDMENT RECORD	12
2. ACRONYMS LIST	13
3. REFERENCE DOCUMENTS	15
4. DESCRIPTION OF MODE S DAPS DATA	17
4.1 MODE S ELS	17
4.2 MODE S EHS	18
4.3 ADS-B DAPS	19
4.4 THE DATA ITEM IN SSR DAPS AND ADS-B DAPS	20
4.5 DAPS DATA EXCHANGE PROTOCOL BETWEEN SURVEILLANCE AND ATM AUTOMATION SYSTEM	21
5. IMPLEMENTATION PRINCIPLES AND PHASES	23
5.1 IMPLEMENTATION PRINCIPLES	23
5.1.1 <i>Stakeholders Coordination</i>	23
5.1.2 <i>System Compatibility</i>	23
5.1.3 <i>DAPS Data Integrity</i>	24
5.1.4 <i>System Integration</i>	24
5.2 IMPLEMENTATION CHECKLIST	25
5.2.1 <i>Activity Sequence</i>	25
5.2.2 <i>Concept Phase</i>	25
5.2.3 <i>Design Phase</i>	26
5.2.4 <i>Implementation Phase</i>	27
6. SYSTEM INTEGRITY AND MONITORING	28
6.1 INTRODUCTION	28
6.2 PERSONNEL LICENSING AND TRAINING	28
6.3 ATS SYSTEM VALIDATION	28
6.3.1 <i>Safety Assessment Guidelines</i>	28
6.3.2 <i>System Safety Assessment</i>	28
6.3.3 <i>Integration Test</i>	29

*Mode S Downlink Aircraft Parameters
Implementation and Operations Guidance Document*

6.3.4	<i>ATS Operation Manuals</i>	29
6.4	SYSTEM MONITORING	29
6.4.1	<i>Consideration for System Monitoring</i>	29
6.4.2	<i>Mode S DAPs Problem Reports</i>	30
6.4.3	<i>Example of Mode S DAPs Problem</i>	31
6.5	APPLICATION ANALYSIS	32
6.5.1	<i>Data Recording</i>	32
6.5.2	<i>Local Data Collection</i>	32
6.5.3	<i>Avionics Problem Identification and Correction</i>	32
6.6	IDENTIFIED ISSUES	32
7.	REGULATIONS AND PROCEDURES	33
7.1	MANDATING MODE S DAPs	33
7.2	AVIONICS	34
7.2.1	<i>Mode S Transponder Capabilities</i>	34
7.2.2	<i>Mode S Transponder Mandate</i>	36
7.2.3	<i>Transition Guidelines</i>	36
7.2.4	<i>Mode S Transponder Working on the Ground</i>	37
7.2.5	<i>1090MHz Extended Squitter Transponder capability</i>	37
7.3	EXTRACT MODE S SSR DAPs USING A MODE S INTERROGATOR	39
7.3.1	<i>Working Principles</i>	39
7.3.2	<i>Interrogator Codes</i>	40
7.3.3	<i>Mode Interlace Pattern</i>	40
7.3.4	<i>Mode S SSR DAPs Extraction using GICB Protocol</i>	41
7.3.5	<i>Mode S SSR DAPs Extraction using AICB Protocol</i>	43
7.3.6	<i>Mode S SSR DAPs Extraction using Comm-B Broadcast</i>	43
7.4	PROVISION OF ADS-B DAPs USING EXTENDED SQUITTER	43
7.4.1	<i>Working Principles</i>	43
7.4.2	<i>ADS-B Message content</i>	44
7.4.3	<i>ADS-B message Transmission Broadcast rate</i>	47
7.5	APPLICATION OF THE MODE S DAPs IN ATM AUTOMATION SYSTEM	49
7.5.1.	<i>Implementation of the General DAPs information</i>	49
7.5.2.	<i>Mode S SSR DAPs</i>	51
7.5.3.	<i>ADS-B DAPs</i>	51
7.6	FLIGHT PLANNING	52
7.6.1	<i>ICAO Flight Plan Item 7 - Aircraft Identification</i>	52
7.6.2	<i>Equipment (Surveillance Equipment /SSR Equipment)</i>	53
7.6.3	<i>Inconsistency between Mode S Flight Planning and Surveillance Capability</i>	54
7.6.4	<i>Setting Flight ID in Cockpits</i>	54
7.7	CONTINGENCY PLAN	55
8.	TRAINING AND COMPETENCY	56
8.1	INTRODUCTION	56
8.2	TRAINING OF AN AIR TRAFFIC CONTROLLER (ATC) IN DAPs	56

*Mode S Downlink Aircraft Parameters
Implementation and Operations Guidance Document*

8.3	TRAINING OF AN ATSEP IN DAPS	56
8.4	COMPETENCY ASSESSMENT OF AN ATSEP IN DAPS	57
9.	SPECIFIC EXAMPLES ON MODE S DAPS APPLICATION	58
9.1	USE OF SELECTED ALTITUDE	58
9.2	USE OF ACAS RA	58
9.3	USE OF MODE-S DAPS DATA FOR WEATHER FORECAST	59
9.4	USE OF BAROMETRIC PRESSURE SETTING	60
9.5	APPLICATION OF GEOMETRIC HEIGHT OF ADS-B IN ANALYSIS OF HEIGHT-KEEPING-PERFORMANCE IN RVSM	60
	APPENDIX 1: MODE S DAPS ANALYSIS	63
	APPENDIX 2: LIST OF IDENTIFIED ISSUES	66
	APPENDIX 3: A BRIEF INTRODUCTION OF MODE S SSR DAPS DATA SOURCE	71
	APPENDIX 4: MODE S PARAMETER SET	78
	APPENDIX 5: RADIO FREQUENCY (RF) MEASUREMENTS AND ANALYSIS	83

1. INTRODUCTION

1.1 Purpose

This Mode S Downlink Aircraft Parameters Implementation and Operations Guidance Document (DAPs IGD) provides guidance for the planning, implementation and operational application of Mode S DAPs technology in the Asia and Pacific Regions.

The procedures and requirements for Mode S DAPs operations are detailed in the relevant States' AIP. This IGD is intended to provide key information on Mode S DAPs performance, integration, principles, procedures and collaboration mechanisms.

The content is based upon the work to date of the Mode S DAPs Working Group and various ANC Panels for the operational use of Mode S DAPs.

1.2 Background

1.2.1 Mode S and DAPs

Mode S (Select) is an extension of conventional SSR which permits selective addressing of individual aircraft equipped with Mode S transponders. Additional data known as Downlink Aircraft Parameters (DAPs) may also be extracted from the aircraft, including aircraft identification which should correspond to the ACID entered in the flight plan.

Mode S operates on the same radio frequencies (1030 and 1090 MHz) as conventional SSR systems, allowing for interrogation of Mode A/C only transponders and Mode S transponders.

Each Mode S equipped aircraft is assigned a unique ICAO 24-bit aircraft address. Using the selective interrogation capability of the Mode S SSR, Mode S Sensors are able to first acquire and then selectively interrogate a specific aircraft via its unique ICAO 24-bit aircraft address. This significantly improves the radar's detection and tracking performance, and therefore improving the ability of ATC to monitor and control the aircraft, as well as the others around it.

The innovation of Mode S resides in the use of selective addressing of aircraft which offers technical advantages over conventional SSR, such as reducing "fruit" and "garbling", providing higher integrity radar tracks.

Mode S technology has the following characteristics:

- a) selective interrogation,
- b) individual aircraft address and
- c) datalink capability.

The Mode S application includes Mode S radar system, datalink Systems, MLAT Systems, etc.

Various avionics systems onboard an aircraft receive data from sensors to provide the DAPs output. The data mainly comes from several sets of sensors, such as air data sensors (including pitot probe, static port, temperature sensor, and angle of attack sensor), inertial sensors (including position gyroscopes, rate gyroscopes and accelerometers) and magnetic sensor(s). Part of the parameters produced by other

*Mode S Downlink Aircraft Parameters
Implementation and Operations Guidance Document*

avionics systems (such as MCP/FCU, FMS, TCAS, etc.) are also defined as downlink aircraft parameters. These parameters are then sent to the transponder through standard data buses, and stored inside the relevant transponder's 256 different 56-bit wide Binary Data Store. Ground-based surveillance systems (such as MSSR or MLAT) can downlink the desired parameters using specific Mode S protocols.

For detailed information about DAPs data source, please refer to Appendix 3.

Mode S DAPs is an application of the Mode S Datalink System. The downlink standard length transaction interface shall deliver DAPs to the transponder which then makes data available to the ground surveillance systems. Each DAP shall be packed and then transmitted by the downlink SLM, ground-initiated and broadcast protocols.

There are 255 Comm-B registers within the Mode S transponder, some of them are assigned for Mode S SSR DAPs and some are assigned for ADS-B DAPs. The Mode S transponder transmits extended squitter to support the ADS-B message transmitted on 1090 MHz which is called ADS-B DAPs. And the SSR DAPs can be extracted using either the ground-initiated Comm-B (GICB) protocol, or using MSP downlink channel 3 via the data flash application.

There are four 1090 MHz Extended Squitter ADS-B MOPS versions with the latest, Version 3 published in December 2020. With each new version, some messages have different formats and contain additional or eliminated message subfields ~~in different versions, as the version 3 was published in December, 2020,~~ As version 3 is so new there are few if any avionics which meet the standards, therefore the related information of ADS-B DAPs in this document is based on the version 2 and earlier versions.

1.2.2 Benefit of Mode S and Use of DAPs

The Mode S application reduces the weakness of Mode A/C, because of the selective interrogation reducing synchronous garble and asynchronous interference. The parity check technique improves the reliability and integrity of surveillance data. The availability of almost 17 million unique aircraft addresses, in conjunction with the automatic reporting of flight identity, alleviates Mode 3/A code shortages and enables unambiguous aircraft identification, if the correct aircraft address and/or Aircraft Identification are entered in both the flight plan and aircraft systems. The datalink technique assists the acquisition of downlink aircraft parameters, and the additional track label information improves the air situational awareness. The controller and pilot are presented with improved situation awareness, which reduces the R/T workload.

Another benefit is to maximize SSR Mode 3/A code savings. By introducing the Mode S Conspicuity Code, all aircraft identified by Mode S via DAPs (ACID) can use the same SSR Mode 3/A code. During the 6th meeting of ATM SG, the following Conclusion is adopted:

Conclusion ATM/SG/6-3: Proposed Air Navigation Plan Volume II Amendment

'A1000' was reserved for the Mode S Conspicuity Code for the ICAO APAC region.

The ADS-B DAPs also provide benefits such as economical, enhanced safety and efficiency. The position report in ADS-B message is transmitted with an indication of the integrity associated with the data. And the ADS-B ground station is simpler than the stations of primary radar, secondary radar and multilateration, and acquisition and installation costs are significantly lower. Since ADS-B messages are broadcast, it supports both ground-based and airborne surveillance applications.

1.3 Arrangement of DAPs IGD

The Mode S DAPs Implementation and Operations Guidance Document consists of the following parts:

Section 1	Introduction
Section 2	Acronym Lists
Section 3	Reference Documents
Section 4	Description of Mode S DAPs Data
Section 5	Implementation Principles and Phase
Section 6	System Integrity and Monitoring
Section 7	Regulations and Procedures
Section 8	Training and Competence
Section 9	Specific Examples on Mode S DAPs Applications

1.4 Document History and Management

The framework of this document was introduced in the first Working Group Meeting of Mode S Downlink Aircraft Parameters in March 2018. The Meeting agreed to further develop based on the proposed framework to a complete document for approval as a regional guidance document. A working team, consisting of volunteers from China, Hong Kong-China, Japan, Malaysia, Singapore, Thailand and New Zealand was established by the Meeting to contribute to the content of the document. In July 2018, the completed draft of this document was ready for circulation among States for review and comment.

The aim of this document to supplement SARPs, PANS and relevant provisions contained in ICAO documentation, and it will be regularly updated to reflect evolving provisions.

1.5 Copies

Paper copies of this DAPs IGD are not distributed. Controlled and endorsed copies can be found at the following website: <http://www.icao.int/APAC/Pages/edocs.aspx> and may be freely downloaded from the website, or by emailing APANPIRG through the ICAO Asia and Pacific Regional Office who will send a copy by return email.

1.6 Changes to DAPs IGD

Whenever a user identifies a need for a change to this document, a Request for Change (RFC) Form (see Section 1.8 below) should be completed and submitted to the ICAO Asia and Pacific Regional Office. The Regional Office will collate RFCs for consideration by the Surveillance Implementation Coordination Group.

When an amendment has been adopted by the meeting of the Surveillance Implementation Coordination Group, then a new version of the DAPs IGD will be prepared, with the changes marked by an “|” in the margin, and an endnote indicating the relevant RFC, so a reader can see the origin of the change. If the change is in a table cell, the outside edges of the table will be highlighted, e.g.:

--	--	--

Final approval for publication of an amendment to the DAPs IGD will be the responsibility of APANPIRG.

1.7 Editing Conventions

(Intentionally blank)

1.8 DAPs IGD Request for Change Form

RFC Nr:	
----------------	--

Please use this form when requesting a change to any part of this DAPs IGD. This form may be photocopied as required, emailed, faxed or e-mailed to ICAO Asia and Pacific Regional Office +66 (2) 537-8199 or APAC@icao.int

1. SUBJECT:			
2. REASON FOR CHANGE:			
3. DESCRIPTION OF PROPOSAL: [expand / attach additional pages if necessary]			
4. REFERENCE(S):			
5. PERSON INITIATING:			DATE:
ORGANISATION:			
TEL/FAX/E-MAIL:			
6. CONSULTATION RESPONSE DUE BY DATE:			
Organization	Name	Agree/Disagree	Date
7. ACTION REQUIRED :		DATE REC'D :	
8. DAPs IGD EDITOR		DATE :	
9. FEEDBACK PASSED			

1.9 Amendment Record

Amendment Number	Date	Amended by	Comments
0.1	20 March 2018	China Hong Kong, China	Initial draft for consideration by Mode S DAPs WG/1
0.2	1 August 2018	China Hong Kong, China Japan Singapore Malaysia	First completed draft based on the agreed document framework in Mode S DAPs WG/1 for review and comment by States
0.3	23 August 2018	China	Based on Version 0.2 draft, China hold a meeting to discuss problems respecting the first completed draft. This is a revised document according to content of this meeting.
0.3.1	26 September 2018	China Hong Kong, China Singapore New Zealand	Based on Version 0.3 draft, States make a full comment on the content of IGD. This is a revised document according to those comments.
0.3.2	6 November 2018	China New Zealand Hong Kong, China Singapore Malaysia	Based on Version 0.3.1 draft, States discussed all comments of IGD in the Mode S DAPs WG 1st Web Conference. This is revised by the meeting decisions.
0.4	27 December 2018	China New Zealand Singapore Australia	Based on Version 0.3.2, States review and comment on the IGD. This is a revised document according to those comments.
1.0	14 March 2019	China Japan Singapore Malaysia	Consideration by Mode S DAPs WG/2
1.1	17 February 2020	China New Zealand Singapore	Modify based on Version 1.0, States review and comment on the IGD.
2.0	13 May 2020	China	Consideration by Mode S DAPs WG/3
3.0	March 2021	China	Consideration by Mode S DAPs WG/4
4.0	March 2022	China	Add information related to ADS-B DAPs and guidance on measurement of 1030/1090 MHz usage

2. ACRONYMS LIST

AA	Aircraft Address
AAD	Assigned Altitude Deviation
AC	Altitude Code
ACAS	Airborne Collision Avoidance System
ACID	Aircraft Identification
ADS-B	Automatic Dependent Surveillance-Broadcast
AICB	Air-Initiated Comm-B
AIGD	ADS-B Implementation and Operations Guidance Document
AIP	Aeronautical Information Publication
AMC	Acceptable Means of Compliance
ANC	Air Navigation Conference
ANSP	Air Navigation Service Provider
APAC	Asia Pacific
ASE	Altimetry System Error
ASTERIX	All Purpose Structured EUROCONTROL Surveillance Information Exchange
ATC	Air Traffic Control
ATM	Air Traffic Management
ATN	Aeronautical Telecommunications Network
ATS	Air Traffic Service
ATSEP	Air Traffic Safety Electronic Personnel
BDS	Comm-B Data Selector
CA	Capability
CDTI	Cockpit Display Traffic Information
CFL	Cleared Flight Level
CLAM	Cleared Level Adherence Monitoring
CNS	Communications, Navigation and Surveillance
DAPs	Downlink Aircraft Parameters
DF	Downlink Format
EASA	European Aviation Safety Agency
EHS	Mode S Enhanced Surveillance
ELM	Extended Length Message
ELS	Mode S Elementary Surveillance
ES	Extended Squitter
EUROCAE	European Organization for Civil Aviation Equipment
EUROCONTORL	European Organization for the Safety of Air Navigation
FCU	Flight Control Unit
FIR	Flight Information Region
FLTID	Flight Identification (transmitted by aircraft)
FMS	Flight Management System
FRUIT	False Relies Unsynchronized In Time
FS	Flight Status
FTE	Flight Technical Error
HDG	Heading
HRD	Horizontal Reference Direction
GICB	Ground-Initiated Comm-B
GNSS	Global Navigation Satellite System
GVA	Geometric Vertical Accuracy
HMI	Human Machine Interface

*Mode S Downlink Aircraft Parameters
Implementation and Operations Guidance Document*

IC	Interrogator Code
ICAO	International Civil Aviation Organization
ID	Identity
IFR	Instrument Flight Rules
II	Interrogator Identifier
IRF	Interrogation Repetition Frequency
MCP	Mode Control Panel
MET	Meteorological
MHz	Megahertz
MIP	Mode Interlace Patterns
MIT	Massachusetts Institute of Technology
MLAT	Multilateration
MOPS	Minimum Operational Performance Standard
MSAW	Minimum Safe Altitude Warning
MSP	Mode S Specific Protocol
MTCD	Medium Term Conflict Detection
NAC	Navigation Accuracy Category
NIC	Navigation Integrity Category
NUC	Navigation Uncertainty Category
RA	Resolution Advisory
RVSM	Reduced Vertical Separation Minimum
SARPs	(ICAO) Standards and Recommended Practices
SFL	Selected Flight Level
SI	Surveillance Identifier
SIL	Surveillance Integrity Level
SSR	Secondary Surveillance Radar
STCA	Short-Term Conflict Alert
TCAS	Traffic Alert and Collision Avoidance System
TRK	Track Angle
TVE	Total Vertical Error
UTC	Universal Time Coordinated
WAM	Wide Area Multilateration
WG	Working Group

3. REFERENCE DOCUMENTS

Id	Name of the document	Edition	Date	Origin	Domain
1	Aeronautical Telecommunications, Annex 10 - Vol. III - Communication Systems	Edition 2	2007	ICAO	
2	Aeronautical Telecommunications, Annex 10 - Vol. IV - Surveillance Radar and Collision Avoidance Systems	Edition 5	2014	ICAO	
3	Doc 9871, Technical Provisions for Mode S Services and Extended Squitter.	Edition 2	2012	ICAO	
4	Doc 9688 Manual on Mode S specific service.	Edition 2	2004	ICAO	
5	ED-73E, Minimum Operational Performance Standards for Secondary Surveillance Radar Mode S Transponders.	Edition 1	May 2011	EUROCAE	
6	ADS-B Implementation and Operations Guidance Document (AIGD)	Edition 13	April 2021	ICAO APAC	
7	Concept of Operations Mode S in Europe (Mode S CONOPS)	Edition 2	November 2013	Eurocontrol	
8	Mode S Elementary Surveillance (ELS) Operations Manual	Edition 1	January 2011	Eurocontrol	
9	Asia/Pacific Seamless ATM Plan		May 2015	ICAO APAC	
10	Doc 9924 Aeronautical Surveillance Manual	Third Edition	2020	ICAO	
11	Preliminary System Safety Analysis for the Mode S Elementary Surveillance	Edition 1.8	April 2004	Eurocontrol	EATMP
12	Elementary Surveillance (ELS) and Enhanced Surveillance (EHS) validation via Mode S Secondary Radar		April 2008	MIT Lincoln Laboratory	ATC Project
13	Aircraft Derived Data Validation Algorithms		August 2012	MIT Lincoln Laboratory	ATC Project
14	Doc.4444 Procedures For Air Navigation Services Air Traffic Management	Sixteenth Edition	November 2016	ICAO	

*Mode S Downlink Aircraft Parameters
Implementation and Operations Guidance Document*

15	Clarification Mode S Transponder in an Airport/A-SMGCS Environment	Edition 1.1	3 May 2005	Eurocontrol	
16	Minimum Operational Performance Standards for Air Traffic Control Radar Beacon System /Mode Select (ATCRBS / Mode S) Airborne Equipment	Edition E	17 March 2011	RTCA	
17	MARK 4 AIR TRAFFIC CONTROL TRANSPONDER (ATCRBS/MODE S)	Edition 4	15 November 2011	ARINC	
18	DO-260 Minimum Operational Performance Standards for 1090 MHz Automatic Dependent Surveillance – Broadcast (ADS-B)		13 September 2000	RTCA	
19	DO-260A Minimum Operational Performance Standards for 1090 MHz Automatic Dependent Surveillance – Broadcast (ADS-B) and Traffic Information Services – Broadcast (TIS-B)		2003	RTCA	
20	DO-260B Minimum Operational Performance Standards for 1090 MHz Automatic Dependent Surveillance – Broadcast (ADS-B) and Traffic Information Services – Broadcast (TIS-B)		2 December 2009	RTCA	
21	Doc9574 Manual on a 300 m(1 000 ft) Vertical Separation Minimum Between FL 290 and FL410 Inclusive	Edition 3	2012	ICAO	

4. DESCRIPTION OF MODE S DAPs DATA

Inside the aircraft transponder, DAPs are stored in different BDS Registers for responding to interrogation requests by a Mode S ground system. Aircraft parameters are periodically delivered from aircraft sensors, flight management system, etc., to these registers via the downlink standard length transaction interface. BDS Registers, which have not been updated within the specified maximum update interval, are cleared or indicated as invalid and such aircraft parameters would be unavailable for ground interrogations. When a Mode S SSR sends an interrogation requesting the downlink of registers, Mode S SSR DAPs are packed into Comm-B format (known as “MB” field) and are extracted using either the GICB protocol or Mode S specific protocols (MSPs) channel 3. Mode S transponder transmit extended squitter to broadcast ADS-B DAPs.

BDS Registers are identified by a two-digit hex number. For example, BDS Register for selected vertical intention, which is identified by hex number 40₁₆, is commonly written as BDS code 4, 0 in publications. Depending on the stage of Mode S implementation, i.e., Mode S ELS and Mode S EHS, the scope of Mode S SSR DAPs data involved would be different as illustrated in the following subsections. These subsections also describe ADS-B DAPs data and the differences between Mode S SSR DAPs and ADS-B DAPs.

Detailed data format and maximum update interval of each BDS register are given in “ICAO Doc 9871 - Technical Provisions for Mode S Services and Extended Squitter”.

4.1 Mode S ELS

In Mode S ELS implementation, aircraft and ground Mode S system should be compliant with providing the following functionalities over conventional Mode A/C systems:

- a) Selective interrogation.
- b) Use of ICAO Aircraft Address.
- c) Automatic reporting of ACID.
- d) Report of transponder capability;.
- e) Altitude reporting with a resolution of 25ft (subject to aircraft capability).
- f) Provision of flight status to indicate airborne or on-the-ground (subject to aircraft capability).
- g) Report of SI Code capability; and
- h) ACAS active resolution advisory report (when equipped with TCAS).

DAPs associated with Mode S ELS are stored in BDS code 1,0, BDS code 1,7, BDS code 2,0 and BDS code 3,0 registers of the aircraft’s transponder.

Table 4-1 DAPs in Mode S ELS

Register	Name	Usage
BDS code 1,0	Datalink Capability Report	To report the data link capability of the Mode S transponder/data link installation.
BDS code 1,7	Common Usage GICB	To indicate common usage GICB services currently

*Mode S Downlink Aircraft Parameters
Implementation and Operations Guidance Document*

	Capability Report	supported.
BDS code 2,0	Aircraft Identification	To report aircraft identification to the ground.
BDS code 3,0	ACAS Resolution Advisory Report	To report ACAS active resolution advisory

With the above functionalities properly configured, Mode S ELS could bring the following benefits to ATC operations:

- a) Provide unambiguous aircraft identification using the unique aircraft address and aircraft identification.
- b) Help to solve Mode 3/A code shortage in congested airspace, using the Mode S conspicuity code (A1000) instead of discrete Mode 3/A codes.
- c) Improve surveillance data integrity by;
 - 1) reducing synchronous garble*,
 - 2) lessening over-interrogations, and
 - 3) simplifying aircraft identification in case of false targets.
- d) Improve the accuracy of multi-surveillance tracking and safety nets with more accurate target detection from Mode S radars and high resolution in altitude reporting; and
- e) Able to process more aircraft tracks than conventional Mode A/C radars; and
- f) Able to provide ACAS active resolution advisory from suitably equipped aircraft.

*Note, while Mode S will help to reduce data garble it will not resolve the issue. Issues around multi-path and different transponder types in close proximity (e.g., Mode A/C near a Mode S transponder) can mean that the return received by the radar may not be correct. In the case of a Mode A/C transponder close to a Mode S transponder, instances have been recorded where the Mode S address has been transposed into the reply from the Mode A transponder.

4.2 Mode S EHS

Mode S EHS implementation includes all the features of Mode S ELS with the addition of DAPs stored in BDS code 4,0, BDS code 5,0 and BDS code 6,0 registers of the aircraft's transponder. The following table summarizes the details of DAPs of these three registers:

Table 4-2 DAPs in Mode S EHS

Register	Name/Downlink Aircraft Parameters		Usage
BDS code 4,0	Selected Vertical Intention	MCP/FCU Selected Altitude	To provide information about the aircraft's current vertical intentions
		FMS Selected Altitude	
		Barometric Pressure Setting	
		MCP/FCU Mode	
		Target Altitude Source	
BDS code 5,0	Track and Turn Report	Roll Angle	To provide track and turn data to the ground systems.
		True Track Angle	
		Ground Speed	
		Track Angle Rate	
		True Air Speed	
BDS code 6,0	Heading	Magnetic Heading	To provide heading and speed data to

*Mode S Downlink Aircraft Parameters
Implementation and Operations Guidance Document*

	and Speed Report	Indicated Air Speed	ground systems.
		Mach Number	
		Barometric Altitude Rate	
		Inertial Vertical Velocity	

In addition to those improvements contributed by Mode S ELS in Section 4.1, Mode S EHS implementation provides the following benefits to ATC operation:

- a) Further improve multi-surveillance tracking accuracy and performance through the use of DAPs on track, turn, speed and heading of the aircraft in the track calculation.
- b) Further improve the accuracy of safety nets, e.g., Short-Term Conflict Alert (STCA), through the provision of more accurate aircraft tracks, and Medium-Term Conflict Detection (MTCD), Minimum Safe Altitude Warning (MSAW), through the provision of the earlier judgment of vertical movement.
- c) Allow the implementation of new safety nets in ATM automation system for cross-checking selected aircraft vertical intention (i.e., Selected Altitude) with ATC controllers' instruction as well as verifying the barometric pressure setting applied in the aircraft with QNH setting in ATM automation system; and
- d) Improve situational awareness of ATC controllers by enabling the direct access of aircraft parameters in ATM automation system, e.g., Indicated Air Speed, Mach speed, Selected Altitude, Barometric Pressure Setting, etc.
- e) Progressive reduction of R/T workload per aircraft.

4.3 ADS-B DAPs

According to the current situation and operation requirements of airborne ADS-B transponder, only the aircraft downlink parameters corresponding to ADS-B 1090ES Version 2 are considered. DAPs associated with ADS-B are stored in BDS Code 0,5, BDS Code 0,6, BDS Code 0,8, BDS Code 0,9, BDS Code 6,1, BDS Code 6,2 and BDS Code 6,5.

The following table summarizes the details of these parameters:

Table 4-3 ADS-B DAPs

Register	Name/Downlink Aircraft Parameters		Usage
BDS code 0,5	Airborne Position	Airborne Position	To provide accurate airborne position information
		NIC Supplement-B	
		Pressure Altitude GNSS Height	
		Surveillance Status	
BDS code 0,6	Surface Position	Surface Position	To provide accurate surface position information.
		Ground Speed Vector	
BDS code 0,8	Aircraft Identification and Category	Aircraft Identification	To provide aircraft identification and category
		Emitter Category	
BDS code 0,9 Subtype 1/2	Velocity Over Ground	Ground Speed Vector	To provide additional state information for both normal and supersonic flight
		NACv	
		Vertical Rate	

*Mode S Downlink Aircraft Parameters
Implementation and Operations Guidance Document*

		Intent Change Flag	
		Difference from Baro Altitude	
BDS code 0,9 Subtype 3/4	Airspeed and Heading	Air Speed	To provide additional state information for both normal and supersonic flight based on airspeed and heading
		Heading	
		NACv	
		Vertical Rate	
		Intent Change Flag	
		Difference from Baro Altitude	
BDS code 6,1 Subtype 1	Emergency/Priority Status	Emergency/Priority Status	To provide additional information on aircraft status
		Mode A Code	
BDS code 6,1 Subtype 2	ACAS RA Broadcast	ACAS RA Report	To report RAs generated by TCAS/ACAS equipment.
BDS code 6,2 Subtype 1	Target State and Status Message	Selected Altitude	To provide aircraft state and status information
		Barometric Pressure Setting	
		Selected Heading	
		NAC _P , SIL, NIC _{BARO} ,	
		SIL Supplement	
		MCP/FCU Mode	
		TCAS/ACAS Operational	
BDS code 6,5 Subtype 0	Aircraft Operational Status-While Airborne	Airborne Capability Class	To provide the capability class and current operational mode of ATC-related applications and other operational information.
		Airborne Operational Mode	
		MOPS Version	
		NIC Supplement-A	
		NAC _P , GVA, SIL, NIC _{BARO}	
		HRD	
		SIL Supplement	
BDS code 6,5 Subtype 1	Aircraft Operational Status-On the Surface	Surface Capability Class	
		Length/Width	
		Surface Operational Mode	
		MOPS Version	
		NIC Supplement-A	
		NAC _P , SIL	
		TRK/HDG	
		HRD	
		SIL Supplement	

4.4 The Data Item in SSR DAPs and ADS-B DAPs

The airborne Mode S transponder may transmit the same data item to radar and ADS-B via different routes. The following table summarizes some of the parameters in use.

Table 4-4 The Data Item in SSR DAPs and ADS-B DAPs

Data Items	SSR DAPs		ADS-B DAPs	
	BDS/DF	ASTERIX	BDS/DF	ASTERIX
Aircraft Address	DF4/5/20/21 AP DF11 AA	I048/220	DF17 AA	I021/080
Mode A Code	DF5/21_ID	I048/070	BDS Code 6,1	I021/070
Pressure Altitude	DF4/20_AC	I048/090	BDS Code 0,5	I021/145
Airborne/On-the-ground	DF4/5/20/21_FS	I048/230	Determine by position	I021/040

*Mode S Downlink Aircraft Parameters
Implementation and Operations Guidance Document*

			message type (BDS Code 0,5 or 0,6)	
Aircraft Identification	BDS Code 2,0	I048/240	BDS Code 0,8	I021/170
Aircraft Emitter Category	-	-	BDS Code 0,8	I021/020
Special Position Indication/SPI	DF4/5/20/21_FS	I048/020 I048/230	BDS Code 0,5	I021/200
Emergency Status	DF5/21_ID	I048/230 I048/070	BDS Code 6,1	I021/200
ACAS RA Report	BDS Code 3,0	I048/260	BDS Code 6,1	I021/260
MCP/FCU Selected Altitude	BDS Code 4,0	I048/250	BDS Code 6,2	I021/146 I021/148
FMS Selected Altitude	BDS Code 4,0		BDS Code 6,2	I021/146
Barometric Pressure Setting	BDS Code 4,0		BDS Code 6,2	I021/REF
MCP/FCU Mode	BDS Code 4,0		BDS Code 6,2	I021/148 I021/REF
Roll Angle	BDS Code 5,0		-	I021/230
True Track Angle	BDS Code 5,0		BDS Code 0,9+6,5 BDS Code 0,6+6,5	I021/160
Ground Speed	BDS Code 5,0		BDS Code 0,9 BDS Code 0,6	I021/160
Track Angle Rate	BDS Code 5,0		-	I021/165
True Air Speed	BDS Code 6,0		BDS Code 0,9	I021/151
Magnetic Heading	BDS Code 6,0		BDS Code 0,9+6,5 BDS Code 0,6+6,5	I021/152
Indicated Air Speed	BDS Code 6,0		BDS Code 0,9	I021/150
Mach Number	BDS Code 6,0		-	-
Barometric Altitude Rate	BDS Code 6,0		BDS Code 0,9	I021/155
Inertial Vertical Velocity	BDS Code 6,0			-
Position in WGS-84 Co-ordinates	-		-	BDS Code 0,5 BDS Code 0,6
GNSS Height	-	-	BDS Code 0,5 + 0,9 BDS Code 0,5	I021/140
Geometric Vertical Rate	-	-	BDS Code 0,9	I021/157
Quality Indicator	-	-	BDS Code 0,5 BDS Code 0,9 BDS Code 6,2 BDS Code 6,5	I021/090
Aircraft Length and Width	-	-	BDS Code 6,5	I021/271
GNSS Antenna Offset	-	-	BDS Code 6,5	I021/REF

Note: The airspeed and magnetic heading values are only available from airborne participants that are not providing information about their velocities over the ground in ADS-B DAPs.

4.5 DAPs Data Exchange Protocol Between Surveillance and ATM Automation System

The decoding of DAPs data from downlink messages is handled by ground surveillance equipment such as radars, ADS-B, MLAT and WAM ground stations. The Surveillance Data Processor (SDP) within the ATM automation system can combine multiple downlink messages into a single target report for display to controllers. All Purpose Structured EUROCONTROL Surveillance Information Exchange (ASTERIX)

formats are commonly used as the protocol for target report transmission from surveillance systems to the ATM automation system.

For detailed information about ASTERIX formats please refer to the following link of EUROCONTROL web site:

<https://www.eurocontrol.int/asterix>

ASTERIX formats are categorized based on the types of surveillance data involved. ASTERIX Category 20, ASTERIX Category 21 and ASTERIX Category 48 are responsible for the DAPs data transmission from MLAT systems, ADS-B systems and radars respectively. For each ASTERIX category, the protocol format is further divided into different editions with variations on the supported DAPs data. ANSP's should carry out appropriate studies on the available protocol editions during the design stage to ensure the chosen format can cater to the scope of DAPs proposed to be implemented and that the Surveillance and ATM automation systems can correctly process the protocol selected.

For details, previous and current versions of ASTERIX Category 20, Category 21 and Category 48 specification documents can be downloaded from the following link of EUROCONTROL web sites:

<https://www.eurocontrol.int/publication/cat020-eurocontrol-specification-surveillance-data-exchange-asterix-part-14-category-20>

<https://www.eurocontrol.int/publication/cat021-eurocontrol-specification-surveillance-data-exchange-asterix-part-12-category-21>

<https://www.eurocontrol.int/publication/cat021-eurocontrol-specification-surveillance-data-exchange-asterix-part-12-category-0>

<https://www.eurocontrol.int/publication/cat048-eurocontrol-specification-surveillance-data-exchange-asterix-part4>

5. IMPLEMENTATION PRINCIPLES AND PHASES

Implementation guidance is developed to progress the DAPs implementation from concept to operational use in the ICAO APAC region. In this chapter, section one addresses the implementation principles, which describes the issues of international coordination, system compatibility, data integrity and system integration, while section two addresses the implementation phase, to assist States with the management of DAPs implementation activities.

5.1 Implementation Principles

5.1.1 Stakeholders Coordination

DAPs provide useful information from aircraft which can benefit ANSP and airspace users. Improvements in efficiency and safety can be achieved, however the resultant changes in operational procedures to provide the improvements, will affect ANSPs, Regulators, Airlines, and other related airspace users. Before implementation by any State, a coordination team should be formed to study, coordinate, support and consult the implementation plans and related activities. The coordination team should include field experts on avionics, data link, surveillance infrastructures and end users.

Changes in the ATM operational procedures as the result of the use of DAPs require coordination among ATS providers, Regulators, Airlines, and where applicable, coordination among neighboring States to maximize the benefits. All States are encouraged to share their operational experiences, and to report anomalies through Mode S DAPs WG and the Surveillance Implementation Coordination Group.

Not all Surveillance and ATM automation systems are capable of processing and using DAPs, therefore investment in all related fields needs to be considered by all States. The coordination team should be consulted for future investment plans and related activities considering the technical and operational aspects. Consideration needs to be given to achieve a balance between investment and benefits.

5.1.2 System Compatibility

a) Technical:

DAPs can be obtained by different surveillance technologies such as Mode S Radar, ADS-B, MLAT and WAM, however not all the transponders can support DAPs. Different surveillance technologies in the ICAO APAC States mean that system compatibility should be considered.

Potential interference between different surveillance technologies should be fully considered before implementation, otherwise the efficiency and safety of the system cannot be ensured. Harmonization between different technologies should be considered and optimized to reduce the RF congestion on 1030MHz and 1090MHz.

Since not all aircraft are equipped with Mode S transponders, and not all the Mode S transponders have the ability to support DAPs, compatibility and efficiency should always be considered before implementation.

When DAPs are implemented, the data rate will increase compared to the conventional radar data, and the related BDS information extraction strategies should be considered. To reduce the load on the 1090MHz spectrum, only those registers intended for operational use should be interrogated/extracted.

b) Operational:

Different processing systems can support DAPs in different levels, hence the quality and information of the target may be different after the processed DAPs have been added. For example, some radar tracking algorithms will consider DAPs as an input to the tracking, so the quality and information of the target will be a little bit different, therefore there should be compatibility considerations between different systems before use of the target data.

There are different air traffic management and operation strategies used by neighboring States. So, the operational procedures should always consider the operational compatibilities. For example, Mode A/C transponders and Mode S transponders may be working in the same area.

5.1.3 DAPs Data Integrity

DAPs data integrity should always be the first consideration when putting DAPs data into use. Since the data integrity from the source is not delivered by any related BDS register now, States are encouraged to find a reliable methodology to ensure the data integrity before the use of the data. Additionally, ongoing means of determining data integrity should be implemented, along with an ability to exclude invalid DAPs data from ATM automation systems.

States which already have experience on data integrity are encouraged to share this information with other States. The coordination team could support and harmonize this activity, and provide a standard method to evaluate the data integrity, and share the method with all the States.

5.1.4 System Integration

By introducing DAPs, the target characteristic from the source to the end user may be different compared to pre-DAPs implementation. In different phases of the processing flow of target data, DAPs can be used by different systems to improve tracking performance. Some key points in the data flow are as follows:

a) Airborne Avionics Systems

As DAPs data comes from different kinds of sensors and avionics systems on the aircraft, the reliability of the data should be ensured before the data is used operationally. Research has shown that some BDS data is missing or not updated correctly. The reasons for this need to be established, as it can mean that the use of some DAPs data is not suitable for implementation. Examples of issues include:

- 1) Older Flight Management Systems which do not provide all the DAPs data, and
- 2) Incorrect installation (e.g., onboard equipment wired to wrong registers)

b) Ground Sensor Systems

Ground sensors may use the DAPs to improve their target tracking performance, having an impact on the tracking function; the target data produced by this kind of sensors will show different characteristics to the pre-DAPs implemented tracking function, such as the turning rate, the kinematic movement and so on. Data users need to be aware of this performance improvement.

c) Ground Automation Systems

Ground automation systems can use DAPs information for a wide variety of uses, such as for tracking, safety net processing, situational awareness, en-route meteorological information sharing and so on. Ensuring DAPs information is processed and used in an appropriate way should be considered during implementation.

d) Other Surveillance Systems

Any DAPs data should be capable of being integrated with other surveillance systems data, and any potential difference and impact should be considered before use. Some of the information can be cross checked by different surveillance technologies.

e) Other Related Systems

5.2 Implementation CHECKLIST

The purpose of this implementation checklist is to document the range of activities that need to be considered to bring a DAPs application from an initial concept to operational use. Some activities of this checklist may be specific to individual stakeholders.

5.2.1 Activity Sequence

The activities are listed in approximate sequential order. However, each activity does not have to be completed prior to starting the next activity. In many cases, a parallel and iterative process should be used to feed data and experience from one activity to another. It should be noted that not all activities will be required for all applications.

5.2.2 Concept Phase

- a) Construct operational concept:
 - 1) Purpose.
 - 2) Operational environment.
 - 3) ATM functions; and
 - 4) Infrastructure.

- b) Identify benefits:
 - 1) Safety enhancements.
 - 2) Efficiency.
 - 3) Capacity.
 - 4) Environmental.
 - 5) Cost reductions.
 - 6) Accessibility; and
 - 7) Other metrics (e.g., predictability, flexibility, usefulness);

- c) Identify constraints:
 - 1) Air-Ground interoperability.
 - 2) Compatibility with non-equipped aircraft.
 - 3) Need for exclusive airspace.
 - 4) Required ground infrastructure.
 - 5) RF spectrum.
 - 6) Integration with existing technology.
 - 7) Technology availability; and

- 8) Actuality of existing infrastructure.

- d) Prepare business case:
 - 1) Cost benefit analysis; and
 - 2) Demand and justification.

5.2.3 Design Phase

- a) Identify operational requirements:
 - 1) Security; and
 - 2) Systems interoperability.

- b) Identify human factors issues:
 - 1) Human-machine interfaces.
 - 2) Training development and validation.
 - 3) Workload demands.
 - 4) Role of automation vs. role of human.
 - 5) Crew coordination/pilot decision-making interactions; and
 - 6) ATM collaborative decision-making.

- c) Identify technical requirements:
 - 1) Standards development.
 - 2) Prevailing avionics standards.
 - 3) Data required.
 - 4) Functional processing.
 - 5) Functional performance.
 - 6) Required certification levels; and
 - 7) Identify the infrastructure that needs upgrade.

- d) Equipment development, test, and evaluation:
 - 1) Prototype systems built to existing or draft standards/specifications.
 - 2) Upgrade and test scheme for the existing infrastructure.
 - 3) Developmental bench and flight tests.
 - 4) Acceptance test parameters: Acceptance test should be performed to ensure all the key indicators are met; and
 - 5) Select and procure technology.

- e) Develop procedures:
 - 1) Pilot and controller actions and responsibilities.
 - 2) Standardize the interaction and phraseologies.
 - 3) Controller's responsibility to maintain a monitoring function, if appropriate.
 - 4) System certification procedure should be made.

*Mode S Downlink Aircraft Parameters
Implementation and Operations Guidance Document*

- 5) Standard Operating Procedure should be made if the human machine interface of the system is changed.
 - 6) Contingency procedures: For example, duplicate Mode S address is detected.
 - 7) Emergency procedures, for example ACAS message is received.
 - 8) General procedures for unforeseen issues should be made; and
 - 9) Develop AIP and Information documentation.
- f) Prepare design phase safety case:
- 1) Safety rationale.
 - 2) Safety budget and allocation; and
 - 3) Functional hazard assessment.

5.2.4 Implementation Phase

- a) Prepare implementation phase safety case.
- b) Conduct operational test and evaluation:
 - 1) Flight deck and ATC validation simulations; and
 - 2) Flight tests and operational trials.
- c) Obtain systems certification:
 - 1) Aircraft equipment; and
 - 2) Ground systems.
- d) Obtain regulatory approvals:
 - 1) Air traffic certification of use.
- e) Impact Assessment

An impact assessment should be conducted to gauge the effect in terms of security, efficiency, operating regulations, human factors, infrastructure, environment, and so on.
- f) Implementation transition:
 - 1) Promulgate procedures.

The regulatory authority shall promulgate general regulations to the participants. Each participant shall formulate corresponding detailed regulations.
 - 2) Deliver training.

Training should be conducted to ensure the personnel is familiar with the standard, regulation, and technology of the Mode S DAPs implementation and operation. Licensing process could be executed if needed.
 - 3) Continue data collection and analysis.
 - 4) Resolve any unforeseen issues; and
 - 5) Continue feedback into standards development processes.
- g) Performance monitoring to ensure that the agreed performance is maintained.

6. SYSTEM INTEGRITY AND MONITORING

6.1 Introduction

CNS and ATM environment is an integrated system including physical systems (hardware, software, and communication networks), human elements (pilots, controllers, and engineers), and the operational procedures for its applications. The integration of Mode S DAPs with other surveillance technologies enables more information from an aircraft to be used to provide a safer service.

Because of the integrated nature of such system and the degree of interaction among its components, comprehensive system monitoring is recommended. The procedures described in this section aim to ensure system integrity by validation, identification, reporting and tracking of possible problems revealed during system monitoring with appropriate follow-up actions.

6.2 Personnel Licensing and Training

Prior to operating any element of the Mode S DAPs system, operational and technical personnel shall undertake appropriate training as determined by the ANSP or State Regulatory Authority, including compliance with the Convention on International Civil Aviation where applicable. Such training will ensure that personnel are familiar with the regulation, standards and requirements of the Mode S DAPs implementation and operation.

6.3 ATS System Validation

6.3.1 Safety Assessment Guidelines

To meet system integrity requirements, ANSPs or States should conduct a validation process that confirms the integrity of their equipment and procedures. Such processes shall include:

- a) A system safety assessment for new implementations is the basis for definitions of system performance requirements. Where existing systems are being modified to utilize additional services, the assessment demonstrates that the ATS Provider's system will meet safety objectives.
- b) Integration test results confirming interoperability for operational use of airborne and ground systems; and
- c) Confirmation that the ATS operation procedure is compatible with those of adjacent providers where the system is used across a common boundary.

6.3.2 System Safety Assessment

The objective of the system safety assessment is to ensure that the implementation and operation of Mode S DAPs are safe. The safety assessment should be conducted for implementation as well as any future enhancements and should include:

- a) Identifying failure or error conditions.
- b) Assigning levels of criticality.
- c) Determining risks/probabilities for occurrence.

- d) Identifying mitigating measures.
- e) Categorizing the degree of acceptability of risks; and
- f) Operational hazard ID process.

Following the safety assessment, States should institute measures to offset any identified failure or error conditions that are not already categorized as acceptable. This should be done to reduce the probability of their occurrence to an acceptable level. This could be accomplished through the automation of procedures.

6.3.3 Integration Test

States should conduct trials with suitably equipped aircraft to ensure the DAPs data meets the operational and technical requirements to provide ATS. The introduction of the Mode S DAPs will give more information about the aircraft, and should not affect the performance of the existing system. States should be satisfied by test results and analysis carried out by the ANSP.

6.3.4 ATS Operation Manuals

States may coordinate with adjacent States to confirm that their ATS operation manuals contain standard operating procedures to ensure harmonization of procedures that impact across common boundaries.

6.4 System Monitoring

During the implementation and operation of the Mode S DAPs technology, routine collection of data is necessary to ensure that the system continues to meet or exceed its performance, safety and interoperability requirements, and that operational service delivery and procedures are working as intended.

6.4.1 Consideration for System Monitoring

Mode S transponders may have been installed a long time ago to support mandatory ACAS functionality. The Mode A/C function has been permanently used by ATC, but the Mode S functions may not have been used. Any failure impacting Mode A/C would have been detected by ATC during normal operation and corrective action would have been undertaken. Before implementing Mode S for surveillance, system checks are usually made to ensure the correct operation of the Mode S transponders (e.g., continue to correctly process Mode A/C and Mode S replies), but possibly no system checks were made to ensure that the DAPs data was correct, so several undetected failures may have existed over the years of operation.

A number of Mode S transponder from different OEMs have been observed to be non-compliant with Annex 10 Volume IV requirements (e.g., no SI code capability, no reply to aircraft register extraction, incorrectly configured aircraft address, incorrect content of BDS registers), even though the transponder is certified to level 2. Although actions have been taken in some areas (mainly where Mode S has been implemented) to address these problems, some aircraft with Mode S which are not working correctly still operate (mostly in areas where Mode S has not yet been implemented).

During the initial deployment of European Mode S, it was discovered that avionics upgrade performed on some aircraft had resulted in erroneous transponder operations so that, in some cases, the aircraft could not even be detected by the ground radar. It is therefore recommended that before commencing Mode S surveillance operations in a given airspace, system monitoring be put in place for timely

*Mode S Downlink Aircraft Parameters
Implementation and Operations Guidance Document*

detection and rectification of hidden transponder problems. This will enable the ANSP and aircraft operators to remedy identified issues prior to using Mode S operationally.

The communication lines for transferring surveillance information in a Mode S radar require much higher data throughput as there is more information per aircraft. For example, compared to a Mode A/C radar, Mode S DAPs require up to three times more data throughput.

Mode S DAPs bring safety benefits even when only a portion of the traffic is properly equipped. Some aircraft can be configured to provide additional data items, but their use should be considered with caution since some airborne installations may not have been certified, hence data may be erroneous. System monitoring to validate the transmitted information is considered desirable for DAPs operation.

6.4.2 Mode S DAPs Problem Reports

During the application of the Mode S DAPs, some problems may be found during the observation of one or more specific events. Faulty Mode S DAPs data should be recorded and analyzed. Problems may be found during the routine analysis of application data. Any problem should be documented and reported to the DAPs WG.

After a problem has been found, the finder can attempt to resolve it with the appropriate party and report the solution to the DAPs WG. The problem and solution will be distributed to the DAPs WG members. If the problem has not been resolved, the problem should be reported to the DAPs WG, and members will be encouraged to resolve the problem. In many cases, a Mode S DAPs problem will be systematic across a particular aircraft or avionics configuration. Engagement with, and correction by the manufacturer may be required.

The mode S DAPs problem should be reported with the form as shown in Table 6-1.

Table 6-1 Mode S DAPs Problem Report Form

PRS#			
Start Time/Date UTC		End Time/Date UTC	
Registration		Aircraft ID	
Flight ID		ICAO Aircraft Address	
Aircraft Type			
Flight Sector/ Location			
ATS Unit			
Description / additional information			
Originator		Originator Reference number	
Organization			

PRS#: A unique identification number assigned by the PRS Administrator to this problem report. Organizations writing problem reports are encouraged to maintain their internal list of these problems for tracking purposes. Once the problems have been reported to the PRS and incorporated in the database, a number will be assigned by the PRS and used for tracking by the SURICG.

Start Time/Date UTC: UTC time/date when the event started.

End Time/Date UTC: UTC time/date when the event ended.

Registration: Registration number (tail number) of the aircraft involved.

*Mode S Downlink Aircraft Parameters
Implementation and Operations Guidance Document*

Aircraft ID:	Coded equivalent of call sign as entered in FPL Item 7.
Flight ID:	The Flight ID/Flight Number downlinked from the aircraft.
ICAO Aircraft Address:	Unique aircraft address expressed in Hexadecimal form.
Aircraft Type:	The aircraft model involved. For the aircraft type designators please refer to ICAO Doc 8643.
Flight Sector/Location:	The departure airport and destination airport for the sector being flown by the aircraft involved in the event. For the airport indicators please refer to ICAO Doc 7910 or related AIP. Or if more descriptive, give the location of the aircraft during the event.
ATS Unit:	ICAO identifier of the ATC center or tower controlling the aircraft at the time of the event.
Originator:	Point of contact at the originating organization for this report (usually the author).
Organization:	The name of the organization (airline, ATS provider or communications service provider) that created the report.
Description:	<p>This should provide as complete a description of the situation leading up to the problem as is possible. Where the organization reporting the problem is not able to provide all the information (e.g., the controller may not know everything that happens on the aircraft), it would be helpful if they would coordinate with the other parties to obtain the necessary information. The description should include:</p> <ul style="list-style-type: none">a) A complete description of the problem that is being reportedb) The route contained in the FMS and flight planc) Any flight deck indicationsd) Any indications provided to the controller when the problem occurrede) Any additional information that the originator of the problem report considers might be helpful but is not included on the list above <p>If necessary, to contain all the information, additional pages may be added. If the originator considers it might be helpful, diagrams and other additional information (such as printouts of message logs) may be appended to the report.</p>

6.4.3 Example of Mode S DAPs Problem

Through monitoring, it has been reported that erroneous DAPs data have been observed due to failure or improper setting/installation of Mode S equipment. A Working Paper of the ICAO Surveillance Panel Working Group (WP ASP12-20) has indicated that a lot of incorrect, outdated and even erroneous data and parameters are present for DAPs data. The errors and/or miss-matches can be frequent, including:

- a) The ACID is not always correct (erroneous)
- b) The Selected Altitude is not correct or is not updated (For example Selected Altitude data should be provided by the MCP/FCU instead of the FMS as the FMS data is usually incorrect).
- c) Mode S DAPs data does not correspond to the content of the requested register (BDS swap).

6.5 Application Analysis

During the Operation of Mode S DAPs application, the analysis is necessary to ensure that the system continues to meet or exceed its performance, safety, and interoperability requirements. To analyze the Mode S DAPs applications, routine data should be recorded.

6.5.1 Data Recording

It is recommended that ATS providers and communication service providers retain the records defined below for at least 30 days to allow for accident/incident investigation processes. These records should be made available on request to the relevant State safety authority. Where data is sought from an adjacent State, the usual State to State channels should be used.

Where possible these recordings shall be in a form that permits a replay of the situation and identification of the messages that were received by the ATS system. Data exchange across borders may not be possible due to different Radar or ATM message formats or to State regulatory issues.

Not only the data from ground equipment, but also the data from aircraft equipment should be recorded. By analyzing the recorded data, the exact reason for the failures can be found.

6.5.2 Local Data Collection

ATS providers and communication service providers should identify and record Mode S DAPs system component failures that have the potential to negatively impact the safety of controlled flights or compromise service continuity.

6.5.3 Avionics Problem Identification and Correction

ATS providers should develop systems or procedures to:

- a) detect Mode S DAPs avionics anomalies and faults
- b) advise the regulators and where appropriate the aircraft operators on the detected Mode S DAPs avionics anomalies and faults
- c) devise mechanisms and procedures to address identified faults

Regulators should ensure that appropriate corrective actions are taken to address identified faults.

An example of Mode S DAPs analysis is taken in Appendix 1.

6.6 Identified Issues

Several identified issues had already been recognized during the implementation of the Mode S DAPs data application in the ATM automation system. Some of them even disrupted the operation of ATC services. Thus, it is necessary to ensure the reliability of DAPs for utilization for ATC operation. This section will present some issues for helping to figure them out.

Based on the experience gained from States, the common Mode S SSR DAPs problems are summarized under different categories in Appendix 2 ,and ADS-B DAPs problems can refer to the Appendix2 of AIGD. It is noted that many cases of the wrong DAPs found in Mode S implementation were because of the aircraft avionics capability. Some issues resulted from human factors. Experiences showed that it was important to keep close coordination with airlines to promote the DAPs application. Airlines should be informed of the issues in time and to check their aircraft Mode S transponders promptly. At the same time, airlines need to improve their working procedures including ensuring they file flight plans correctly.

7. REGULATIONS AND PROCEDURES

Mode S DAPs involve the transmission of specific data from aircraft. These data messages can be interrogated by the ground equipment (Mode S interrogator) or broadcast by the Mode S extend squitter. ATM uses the data to show the more precise and integrated situation of the surveilled aircraft. The following procedures relate to the use of Mode S DAPs data in ATS ground surveillance applications.

The implementation of the Mode S DAPs system will support the provision of high-performance surveillance, enhancing flight safety, improving the controller efficiency, and reducing the workload of both the controller and pilot.

7.1 Mandating Mode S DAPs

- a) Depending on the type of operations that States are going to conduct, States will have to consider whether there is a need to publish mandates. Some operations will require all aircraft within airspace to be suitably equipped while others can still work well on a ‘best equipped best served’ basis.
- b) Use of Multilateration on airport surface is an example of an operation where it is recommended for all aircraft to be equipped with Mode S transponders. Another example is the conspicuity code environment, where Flight Identification may be used as the prime means to couple/correlate flight plans, allowing ANSPs to overcome the shortage of Mode A codes. Equipage mandates would be necessary for such operations.
- c) States intending to implement ADS-B based surveillance services may designate portions of airspace within their area of responsibility by:
 - i. *mandating the carriage and use of ADS-B equipment; or*
 - ii. *providing priority for access to such airspace for aircraft with operative ADS-B equipment over those aircraft not operating ADS-B equipment.*
- d) With appropriate software, ATM automation systems can use Mode S DAPs to provide additional information to controllers, enabling a reduction in controller workload and the enhancement of Safety Net systems. Equipage mandates are not necessary, but consideration of the nature of the services required and/or a cost-benefit study, may warrant such mandates.
- e) As of May 2018, examples of States which use Mode S SSR DAPs without publishing mandates are Australia¹, New Zealand and Singapore. Examples of States with published mandates for Mode S SSR DAPs are France, Germany and the United Kingdom.
- f) In publishing mandate/regulations, States should:
 - 1) Define the standards applicable to the State.
 - i. E.g., *Joint Aviation Authorities (JAA) Temporary Guidance Leaflets (TGL) 13 Revision 1* for Elementary Surveillance in version 0 and version 1 transponders; or
 - ii. E.g., *European Aviation Safety Agency (EASA) Acceptable Means of Compliance (AMC) 20-13* for Enhanced Surveillance in version 0 and version 1 transponders; or

¹ Australia has a mandate for Mode S transponders at selected airports utilizing Multilateration for surface surveillance, but no widespread mandates for airborne DAPs usage

*Mode S Downlink Aircraft Parameters
Implementation and Operations Guidance Document*

- iii. E.g., *Elementary Surveillance (ELS) requirements stated in European Aviation Safety Agency (EASA) CS-ACNS-Subpart D, Section 2 (i.e., CS ACNS.D.ELS) for Elementary Surveillance in version 2 transponder; or*
 - iv. E.g., *Enhanced Surveillance (EHS) requirements stated in European Aviation Safety Agency (EASA) CS-ACNS-Subpart D, Section 3 (i.e., CS ACNS.D.EHS) for Enhanced Surveillance in Version 2 transponder*
 - v. E.g., *Mode S level 2 if the requirement is simply for Airport Surface Multilateration.*
 - vi. *, ADS-B avionics compliant to Version 2 ES (equivalent to RTCA DO-260B) or later version 2.*
 - vii. E.g., *European Aviation Safety Agency - Certification Considerations for the Enhanced ATS in Non-Radar Areas using ADS-B Surveillance (ADS-B-NRA) Application via 1090 MHZ Extended Squitter (AMC 20-24);or*
 - viii. E.g., *European Aviation Safety Agency - Certification Specifications and Acceptable Means of Compliance for Airborne Communications, Navigation and Surveillance Subpart D — Surveillance (SUR) (CS-ACNS.D.ADS-B);or*
 - ix. E.g., *Federal Aviation Administration – Advisory Circular No: 20-165A (or later versions) Airworthiness Approval of Automatic Dependent Surveillance – Broadcast (ADS-B) Out Systems; or*
 - x. E.g., *the equipment configuration standards in Appendix XI of Civil Aviation Order 20.18 of the Civil Aviation Safety Authority of Australia.*
- 2) Define the airspace affected by the regulations
 - i. E.g., *Within the [FIR Authority] Flight Information Region above Flight Level XXX*
 - 3) Define the category of aircraft that the regulation applies to
 - i. E.g., *Aircraft with a maximum certified take-off mass exceeding 5,700 kg or having a maximum cruising true airspeed capability greater than 250 kt; or*
 - ii. E.g., *All IFR aircraft*
 - 4) Define the timing of the regulations allowing sufficient time for operators to equip.
 - i. E.g., *With effect from 1 Jan 2020.*

Note: More information of mandate for 1090 MHz ADS-B can refer to section 9.2 of AIGD.

7.2 Avionics

7.2.1 Mode S Transponder Capabilities

- a) The various levels of capabilities for Mode S Transponders are described in subsequent paragraphs. The state should select the capability as required by its operations.
- b) According to ICAO Annex 10, Vol. 4, Mode S transponders shall conform to one of five levels of capability as follows:
 - 1) Level 1 is the basic transponder. Level 1 permits surveillance based on Mode A/C as well as on Mode S. With a Mode S aircraft address, it comprises the minimum features for compatible operation with Mode S interrogators. It has no datalink capability and will not be used by international air traffic.

*Mode S Downlink Aircraft Parameters
Implementation and Operations Guidance Document*

- 2) Level 2 has the same capabilities as Level 1 and permits standard length datalink communication from ground to air and air to ground. It includes automatic aircraft identification reporting. This is the minimum level permitted for international flights. Data parity with overlay control (ICAO Annex 10, Vol. 4, 3.1.2.6.11.2.5) for equipment certified on or after 1 January 2020.
 - 3) Level 3 has the capabilities as level 2 and also those prescribed for ground-to-air ELM communications.
 - 4) Level 4 has the capabilities as level 3 and also those prescribed for air-to-ground ELM communications.
 - 5) Level 5 has the capabilities as level 4 and also those prescribed for enhanced Comm-B and ELM communications.
- c) Other than the various levels, transponders also can have the following features:
- 1) Extended squitter - transponders that shall have the capabilities of level 2, 3, 4, or 5 and those prescribed for extended squitter operation.
 - 2) SI Capability - Transponders with the ability to process SI codes shall have the capabilities of level 2, 3, 4, or 5 and those prescribed for SI code operation.
 - 3) Data flash Application – transponders that implement the data flash mode.
 - 4) Hijack Mode Capability – transponders that support the Hijack Mode and have the capabilities of level 2, 3, 4, or 5.
 - 5) ACAS Compatibility –transponders compatible with ACAS.
 - 6) Antenna Diversity – in aircraft with transponder using two antennas, receivers and transmitting channels.
 - 7) According to ED-73E, Elementary Surveillance – elementary surveillance transponders will require at least a level 2 transponder and have the following capabilities:
 - i. Flight status reporting
 - ii. Barometric pressure altitude reporting
 - iii. Transponder capability (CA)
 - iv. II and SI code capable
 - v. Declaration of capability (BDS code 1,0)
 - vi. Common usage GICB capability report (BDS code 1,7)
 - vii. Mode S specific services capability (BDS code 1,8 to BDS code 1,C)
 - viii. Flight identification (BDS code 2,0)
 - ix. ACAS Active Resolution Advisory (BDS code 3,0) if equipped with ACAS II
 - x. Aircraft register (BDS code 2,1) – optional
 - 8) According to ED-73E, Enhanced Surveillance – enhanced surveillance transponders have the capabilities of elementary surveillance transponders, plus the capability to provide the following DAPs:
 - i. Magnetic Heading (BDS code 6,0)
 - ii. Indicated Airspeed and/or Mach No. (BDS code 6,0)
 - iii. Vertical Rate (climb/descend) (BDS code 6,0)
 - iv. True Airspeed (provided if Track Angle Rate is not available) (BDS code 6,0)
 - v. MCP/FCU Selected Altitude (BDS code 4,0)
 - vi. Ground Speed (BDS code 5,0)

*Mode S Downlink Aircraft Parameters
Implementation and Operations Guidance Document*

- vii. Roll Angle (BDS code 5,0)
- viii. Track Angle Rate (if available) (BDS code 5,0)
- ix. True Track Angle (BDS code 5,0)
- x. Barometric Pressure Setting (BDS code 4,0)

Note: For more information of transponder capabilities for 1090 MHz ADS-B refer to section 9.2 and appendix 3 of the AIGD.

7.2.2 Mode S Transponder Mandate

During the 31st APANPIRG meeting, the following Conclusion regarding the fitment of Mode S equipage was adopted, States/Administrations may consider the following conclusion when considering the publishing of Mode S transponder mandate.

Conclusion APANPIRG/31/14 (CNS SG/24/13 (SURICG/5/3(DAPS WG3/1))) - Mode S Forward Fit Equipage in APAC Region	
What: Regarding fitment of Mode S equipage, That, States/Administrations in APAC Region be strongly encouraged to mandate that registered aircraft with a maximum certified take-off mass exceeding 5 700 kg or having a maximum cruising true airspeed capability greater than 250 knots, with a date of manufacture on or after 1 January 2022 be equipped with Mode S avionics compliant with Enhanced Surveillance (EHS).	Expected impact: <input type="checkbox"/> Political / Global <input type="checkbox"/> Inter-regional <input checked="" type="checkbox"/> Economic <input type="checkbox"/> Environmental <input checked="" type="checkbox"/> Ops/Technical
Why: Considering that a number of DAPs applications will require EHS and that it's easy for new aircraft to be equipped with EHS. Retrofitting existing airframes with EHS will need further deliberation under the challenging pandemic situation.	Follow-up: <input checked="" type="checkbox"/> Required from States
When: 16-Dec-20	Status: Adopted by PIRG
Who: <input checked="" type="checkbox"/> Sub groups <input checked="" type="checkbox"/> APAC States <input checked="" type="checkbox"/> ICAO APAC RO <input checked="" type="checkbox"/> APANPIRG <input type="checkbox"/> ICAO HQ <input checked="" type="checkbox"/> Other: SURICG	

7.2.3 Transition Guidelines

- a) Equipage of aircraft will be achieved over a period of time. Not all aircraft will be equipped with the necessary capability. A transition plan is required to accommodate varying degrees of aircraft equipment compliance.
- b) As part of the formulation for a transition plan, States should assess the impact of having aircraft that are not suitably equipped within the affected airspace, to enable the implementation of suitable mitigating measures. States should also collect statistics on the readiness of the aircraft within the affected airspace.
- c) For different operations, the mitigation measures in the transition plan could be different. For example, if the operation is just to use the Mode S DAPs to provide useful information to the controllers, the impact of having unequipped aircraft is minor. Mitigating measures could be as simple as making the controllers aware that not all aircraft are able to provide the information. On the other hand, where mode S is mandated for airport surface Multilateration, mitigating

*Mode S Downlink Aircraft Parameters
Implementation and Operations Guidance Document*

measures for having unequipped aircraft may include having special procedures for non-equipped aircraft or the deployment of a surface movement radar.

7.2.4 Mode S Transponder Working on the Ground

Table 7-1 summarizes the requirements to inhibit or not inhibit replies from aircraft on the ground.

Table 7-1 The Requirements of Transponders on Ground

Type of interrogations	Transponder reply
Mode A/C	Should be inhibited
Mode A/C/S All Call	Shall always be inhibited
Mode S only All Call (UF =11)	Shall always be inhibited
Mode S (Roll call UF=0,4,5,16,20,21,24)	Shall not be inhibited
Acquisition Squitter (Short Squitter)	Shall be inhibited if surface type of extended squitter is transmitted
Extended Squitter (Long Squitter)	Shall not be inhibited

[Information obtained from Eurocontrol's Clarification Mode S Transponder in an Airport/A-SMGCS Environment Ed 1.1 dated 3 May 2005]

- a) Replies to Mode A/C/S all call and Mode S only all call interrogations shall always be inhibited when the aircraft declares the on the ground state. It shall not be possible to inhibit replies to discretely addressed Mode S interrogations regardless of whether the aircraft is airborne or on the ground.
- b) Mode A/C replies should be inhibited (i.e., Mode A/C transponder set to standby) when the aircraft is on the ground to prevent interference when in close proximity to an interrogator or other aircraft. Mode S discretely addressed interrogations do not give rise to such interference. An exception on the recommendation to inhibit Mode A/C replies will be at airports having Multilateration systems working with Mode A/C.
- c) Mode S transponders shall be set to the correct mode according to its flight status (i.e., airborne mode when it's in the air and ground mode when on the ground). When an aircraft is in ground mode, replies to all call are inhibited. It is recommended that aircraft provide means to determine the on-the-ground state automatically and provide that information to the transponder.

7.2.5 1090MHz Extended Squitter Transponder capability

- a) According to the ICAO 1090MH ADS-B Minimum Operational Performance Standard (MOPS), in a Mode S Transponder-Based Subsystem, the ADS-B Message generation function and the modulator and 1090 MHz transmitter are present in the Mode S transponder itself. The transmit antenna subfunction consists of the Mode S antenna(s) connected to that transponder.
- b) According to ICAO Annex 10, Volume 4. Extended squitter ADS-B transmission requirements. Mode S extended squitter transmitting equipment shall be classified according to the unit's range capability and the set of parameters that it is capable of transmitting consistent with the following definition of general equipment classes:
 - 1) Class A extended squitter airborne systems support an interactive capability incorporating both an extended squitter transmission capability (i.e., ADS-B OUT) with a complementary extended squitter reception capability (i.e., ADS-B IN) in support of onboard ADS-B

*Mode S Downlink Aircraft Parameters
Implementation and Operations Guidance Document*

applications.

- 2) Class B extended squitter systems provide a transmission only (i.e., ADS-B OUT without an extended squitter reception capability) for use on aircraft, surface vehicles, or fixed obstructions; and
 - 3) Class C extended squitter systems have only a reception capability and thus have no transmission requirements.
- c) According to the ICAO 1090Mhz ADS-B Minimum Operational Performance Standards (MOPS), the 1090ES ADS-B transponder has 4 versions, which included:
- 1) RTCA DO-260/EUROCAE ED-102 (Version 0)

The International Civil Aviation Organization issued the 1090ES ADS-B initial standard "Minimum Operational Performance Standards for 1090 MHz Extended Squitter Automatic Dependent Surveillance-Broadcast (ADS-B)" (DO-260/ED-102) in September 2000, and was known as ADS-B version 0. This version defines the 1090 MHz ADS-B Transmitting Subsystem takes position, velocity, status, and intent inputs from other systems onboard the aircraft and transmits this information on the 1090 MHz frequency as Mode S Extended Squitter messages.

According to DO-260/ED-102, the 1090ES transponder should send State Vector (SV), Mode Status (MS) Reports, and support the following DAPs capabilities:

- i. airborne position (BDS 0,5).
- ii. surface position (BDS 0,6).
- iii. identification and type (BDS 0,8).
- iv. airborne velocity (BDS 0,9).
- v. emergency/priority status (BDS 6,1).
- vi. Current/Next Trajectory Change Point (TCP) (BDS 6,2).
- vii. Current/Next Trajectory Change Point (TCP+1) (BDS 6,3).
- viii. Aircraft Operational Coordination Message (BDS6,4).
- ix. Aircraft operational status (BDS 6,5).

- 2) RTCA DO-260A (Version 1)

The International Civil Aviation Organization issued "Minimum Operational Performance Standards for 1090 MHz Extended Squitter Automatic Dependent Surveillance - Broadcast (ADS-B) and Traffic Information Services - Broadcast (TIS-B)" (RTCA DO-260A) in April 2003, and was known as ADS-B version 1, The formats and protocols for 1090 ES were revised in part to overcome the limitation of the reporting of surveillance quality using only navigation uncertainty category (NUC). In the revised formats and protocols, surveillance accuracy and integrity are reported separately as:

- i. navigation accuracy category (NAC),
- ii. navigation integrity category (NIC), and
- iii. surveillance integrity level (SIL).

Other features added in Version 1 messages include the reporting of additional status parameters and formats for traffic information service — broadcast and ADS-B rebroadcast (ADS-R). Version 1 formats are fully compatible with those of Version 0, in that a receiver of either version can correctly receive and process messages of either version.

According to D0-260A, the 1090ES ADS-B transponder should send State Vector (SV), Mode Status (MS), Target state (TS), Air Reference Velocity (ARV) Reports, and support the following DAPs capabilities:

*Mode S Downlink Aircraft Parameters
Implementation and Operations Guidance Document*

- i. airborne position (BDS 0,5).
 - ii. Surface Position (BDS 0,6).
 - iii. Aircraft Identification and Category (BDS 0,8).
 - iv. Airborne Velocity (BDS 0,9).
 - v. Aircraft Status (BDS 6,1).
 - vi. Target State and Status (BDS 6,2).
 - vii. Aircraft Operational Status (BDS 6,3).
- 3) RTCA DO-260B/EUROCAE ED-102A (Version 2)

The International Civil Aviation Organization issued "Minimum Operational Performance Standards for 1090 MHz Extended Squitter Automatic Dependent Surveillance - Broadcast (ADS-B) and Traffic Information Services - Broadcast (TIS-B)" (DO-260B/ED-102) in December 2009, and was known as ADS-B version 2. The formats and protocols for 1 090 ES Version 2 were revised based on experience gained from operational usage with ADS-B that revealed a number of needed improvements, which included:

- i. separated reporting of source and system integrity.
- ii. additional levels of NIC to better support airborne and surface applications.
- iii. incorporation of the broadcast of the Mode A code into the emergency/priority message, increased transmission rates after a Mode A code change, and the broadcast of the Mode A code on the surface.
- iv. revision to the target state and status message to include additional parameters.
- v. eliminated the vertical component of NIC and NAC.
- vi. T = 0 position extrapolation accuracy changed from within 200 ms of the time of transmission to within 100 ms; and
- vii. capabilities were added to support airport surface applications.

According to D0-260B/ED-102A, the 1090ES ADS-B transponder should send State Vector (SV), Mode Status (MS), Target State (TS) and Air Reference Velocity (ARV) Reports, and support the following DAPs capabilities:

- i. Airborne Position (BDS 0,5).
- ii. Surface Position (BDS 0,6).
- iii. Aircraft Identification and Category (BDS 0,8).
- iv. Airborne Velocity (BDS 0,9).
- v. Aircraft Status (BDS 6,1).
- vi. Target State and Status (BDS 6,2).
- vii. Aircraft Operational Status (BDS 6,5).

7.3 Extract Mode S SSR DAPs using a MODE S Interrogator

7.3.1 Working Principles

The Mode S interrogator transmits interrogation to elicit replies for detection of Mode S transponders and more information from the aircraft. The use of a unique ICAO 24-bit aircraft address and provision of all the required aircraft data in one reply will reduce interrogation rates.

Each aircraft can be interrogated selectively, needing only one or two 'hits' per aircraft per scan and minimizing interference problems associated with SSR Mode A/C.

The operation of a Mode S interrogator will not interfere with the SSR performance of any aircraft equipped with a Mode A/C transponder.

A Mode S interrogator is capable of performing the conventional surveillance function with Mode A/C transponders.

7.3.2 Interrogator Codes

The Mode S system requires each interrogator to have an IC, which can be carried within the uplink and downlink transmissions. The 4-bit IC uplink field in UF11 shall contain either 4-bit II code or the lower 4 bits of the 6-bit SI codes. It is recommended that whenever possible an interrogator should operate using a single interrogator code.

The II codes shall be assigned to interrogators in the range from 0 to 15. The II code value of 0 shall only be used for supplementary acquisition. The SI codes shall be assigned to interrogators in the range from 1 to 63. The SI code value of 0 shall not be used.

The assignment of interrogator II or SI codes, where necessary in areas of overlapping coverage, across international boundaries of flight information regions, shall be the subject of regional air navigation agreements. The ICAO Asia Pacific Regional Office maintains a register of II codes used – where States have provided this information to the office. States are encouraged to provide this information to the Regional Office and update it when changes are made.

7.3.3 Mode Interlace Pattern

The particular air traffic and environment of each interrogator will influence the selection of suitable interrogation periods, interrogation repeat frequency, MIP and Probability of Reply.

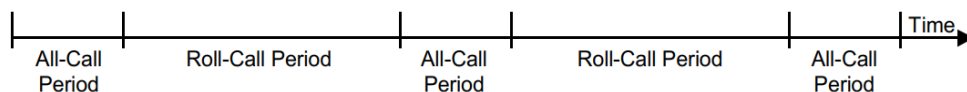

Figure.7-1 The Typical MIP

The repetition frequency and duration of the All-Call period is a local implementation issue (the stated ICAO maximum is 250Hz). The exact duration of either period will depend on the characteristics of the system such as the antenna revolution rate, the beam-width and the maximum range. There will normally be several all-call periods (and hence roll-call periods as one will always follow the other) available to interrogate all targets in range during one revolution.

There is a careful balance between the reliable acquisition of all targets and the potential of flooding the RF environment with unwanted replies to acquisition interrogations. It is necessary to choose an appropriate Mode Interlace Pattern to manage the acquisition activities to ensure minimal interference. The default objective is to define a MIP which effectively detects and performs surveillance on classical SSR Mode A/C aircraft using Mode A/C interrogations which also detects and acquires Mode S aircraft using Mode S interrogations. The MIP is constructed in order to separate Mode A/C and Mode S all-calls from Mode S selective (roll-call) activity. MIP defines the sequences of all-call interrogation types that might be made during cycles of all-call periods. Every interrogator is likely to have different needs and hence different ways of operating.

China presented an IP about the Mode S Parameter Set during the 3rd meeting of DAPs WG. For detailed information please refer to Appendix 4.

7.3.4 Mode S SSR DAPs Extraction using GICB Protocol

The GICB procedure is initiated by a Mode S interrogator for eliciting the Mode S DAPs containing aircraft derived data from a Mode S aircraft installation.

The GICB protocol allows for the immediate transfer of data required by the ground and the extraction of information stored in the Mode S transponder. This information (if available) is contained in the reply to an interrogation specifying the address (BDS code) of the storage location containing that information.

The interrogation with specific BDS can elicit the corresponding Comm-B data where contained in Mode S transponder's registers. The Mode S DAPs can be implemented in two stages: ELS and EHS.

The first processing step for any Mode S data link application is to obtain the transponder CA value from the aircraft. The 3-bit CA field is found in the "Mode S All-Call Reply" (DF=11) and the "Extended Squitter" (DF=17) downlinks. If CA=0, then this transponder is surveillance-only and supports no data link functions at all. If CA \geq 4 indicates that the Mode S transponder is fully capable of at least 56-bit short uplink and downlink message transfer. These Mode S transponders may support the ELS, EHS requirements. The values of CA= 1, 2, 3 are reserved.

Mode S Downlink Aircraft Parameters
Implementation and Operations Guidance Document

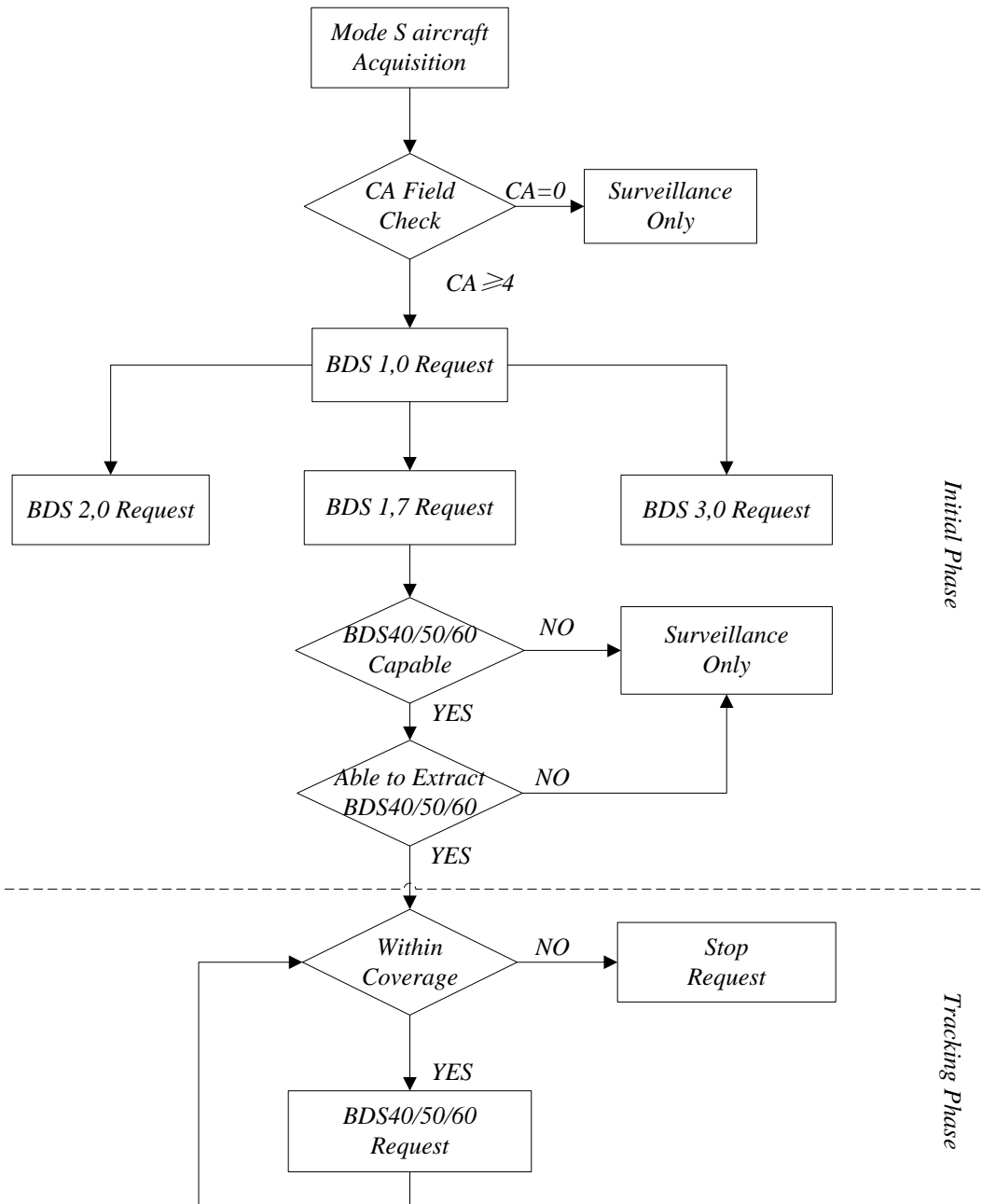

Figure.7-2 The Typical Procedure of DAPs Extraction

Given that the Mode S transponder’s CA value is 4 or greater, the second processing step for any Mode S data link application is to extract the transponder’s Mode S data link capability report register BDS code 1,0. Bits in this register indicate the support of such Mode S data link functions as aircraft identification (register BDS code 2,0), ACAS (register BDS code 3,0), common-usage capability (register BDS code 1,7) etc. The Mode S-Specific services capability bit in register BDS code 1,0 indicates whether the avionics installation supports further data link functions. If this bit is set, the Mode S data link application would next extract the common-usage capability register BDS code 1,7. All of the registers involved with the EHS application have bit flags assigned in this register BDS code 1,7. If the bit flag is set, it indicates that the corresponding register has been updated in a timely manner and contains valid data which can be extracted by the interrogator. The processing protocol is sufficient initialization for

*Mode S Downlink Aircraft Parameters
Implementation and Operations Guidance Document*

basic data link applications such as ELS, EHS since all their status and configuration information is available from register BDS code 1,0 and register BDS code 1,7.

So, the Mode S interrogator should transmit the selective interrogation to elicit the Mode S transponder reply with the specific formats and Comm-B data contained in the corresponding registers.

Normally, the more Comm-B data requested by the Mode S interrogator, the more information can be extracted from the aircraft transponder registers. It will also help the ATC controller get the aircraft's flight status and flight intention. However, there should be some necessary limitations for the Comm-B data request to avoid the phenomenon of Comm-B data discontinuity because of the limited Roll-Call interrogation duration.

It is suggested that the number, periodicity and priority of BDS data extraction rule be reasonably and effectively implemented according to the requirements and the number of aircraft in the airspace. The scientific strategy can ensure the ATC controller gets Comm-B data timely and effectively.

7.3.5 Mode S SSR DAPs Extraction using AICB Protocol

The AICB procedure is initiated by a Mode S transponder for transmitting a single Comm-B segment from the aircraft installation.

Any changes in the contents of ACAS (register BDS code 3,0) triggers a downlink message via the air-initiated Comm-B broadcast protocol including the updated register contents.

An AICB sequence shall start upon the acceptance of a message intended for delivery to the ground sensor. After receipt of this message, the transponder shall set a valid downlink request code of surveillance or Comm-B reply. On receipt of this message with a valid downlink request code, the interrogator could start to extract the message.

AICB messages are announced by the transponder and are transmitted in a subsequent reply only after authorization by the interrogator. AICB messages are announced to all interrogators and can be extracted by any interrogator. The Mode S data link application should update the aircraft's "state" values with the new ones. The changed state might result in discontinuance (or reinstatement) of certain Mode S data link functions. Mode S transponder AICB broadcast messages are held active in the transponder for 18 seconds after the triggering event. Any Mode S sensor can extract the broadcast information.

7.3.6 Mode S SSR DAPs Extraction using Comm-B Broadcast

A Comm-B broadcast is a message directed to all active interrogators in view. Messages are available for 18 seconds unless a waiting AICB interrupts the cycle. Interrogators have no means to cancel the Comm-B broadcast.

Currently, only registers of datalink capability report (register BDS code 1,0) and aircraft identification (register BDS code 2,0) make use of the Comm-B Broadcast.

7.4 Provision of ADS-B DAPs using extended squitter

7.4.1 Working Principles

The "1090 Extended Squitter" is a spontaneous broadcast transmission by the Mode S transponder on the 1090 MHz frequency not initiated by an interrogation on 1030 MHz. The "Automatic Dependent Surveillance – Broadcast (ADS-B)" is a function of airborne or surface aircraft, or other surface vehicles

*Mode S Downlink Aircraft Parameters
Implementation and Operations Guidance Document*

operating in the airport surface area, that periodically transmits its state vector (horizontal and vertical position, horizontal and vertical velocity) and other information via a data link.

The 1090 Extended Squitter allows the transmission of ADS-B messages by means of 1090 Extended Squitter via 1090 MHz. The ADS-B message is formatted data that conveys information used in the development of ADS-B reports that can be used for air traffic management activity. The ADS-B reports can support improved use of airspace, surface surveillance, and enhanced safety such as conflict management.

There are four defined standards for the ADS-B 1090 ES applications. These standardizations were consistent with RTCA/DO-260, RTCA/DO-260A, RTCA/DO-260B and RTCA/DO-260C were termed 1090 ES Version 0, Version 1, Version 2 and Version 3. (1090 ES Version 3 has just been released in December 2020.)

The differences between the first three versions are mainly in the following two areas: (a) its specification of the ADS-B “event driven” transponder register set, and (b) how available avionics surveillance accuracy is specified.

7.4.2 ADS-B Message content

The Mode S transponder has 255 BDS registers. Each register stores aircraft parameters, message or data derived from FMS or other sensors. Some specific registers are defined for the ADS-B application so that related messages can be delivered via ADS-B message broadcast activity.

Table 7-2 Registers Related to ADS-B Application

Register	Content		
	Version0	Version1	Version2
BDS code 0,5	Airborne Position Message		
	Single Antenna Flag		NIC Supplement-B
	Airborne Position		
	Pressure Altitude		
	GNSS Height		
	Surveillance Status		
	BDS code 0,6	Surface Position Message	
Ground Track		Heading	
Surface Position			
Movement			
-			
BDS code 0,8	Aircraft Identification and Type Message		
	Aircraft Category		
	Aircraft Identification		
	-		
BDS code 0,9	Airborne Velocity Message		
	NUC _R	NAC _v	
	IFR Capability Flag		-
	Subtypes 1 and 2: Velocity Over Ground		Subtypes 3 and 4: Airspeed and Heading
	-		

SURICG/7
Appendix A to WP/03

*Mode S Downlink Aircraft Parameters
Implementation and Operations Guidance Document*

	Ground Speed Vector	Air Speed		
		Heading		
	Intent Change Flag			
	Ground Speed Vector			
	Vertical Rate			
	Difference from Baro Altitude			
BDS code 6,1	Version0	Version1	Version2	
	Aircraft Status Message			
	Subtype 1:Emergency/Priority Status		Subtype 2:1090ES TCAS RA Broadcast	
	Emergency Status		ACAS RA	
	-		Mode A Code Report	
BDS code 6,2	Version 0	Version 1	Version 2	
	Current/Next Trajectory Change Point(TCP) Message	Target State and Status Information Message		
	TCP data	Target Altitude	Selected Altitude	
		-	SIL Supplement	
		-	Barometric Pressure Setting	
		Track Heading / Track Angle	Selected Heading	
		Emergency/Priority Status	Mode Engaged (Autopilot VNAV Altitude Approach LNAV)	
		Capability/Mode Code	TCAS Operational	
NAC _P 、SIL、NIC _{BARO}				
BDS code 6,3	Version 0	Version 1	Version 2	
	Current/Next Trajectory Change Point Message(TCP+1)	Aircraft Operational Status Message		
	TCP+1 Data	Subtype 0	Subtype 1	
		Airborne Capability Class	Surface Capability Class	
			Length/Width Codes	
		NIC _{BARO}	TRK/HDG	
		Operational Mode OM		
		Version Number		
		NIC Supplement		
		NAC _P 、SIL		
HRD				
BDS code 6,4	Version 0	Version 1	Version 2	
	Aircraft Operational	-		

*Mode S Downlink Aircraft Parameters
Implementation and Operations Guidance Document*

	Coordination Message				
	Paired Address				
	Runway Threshold Speed				
	Roll Angle				
BDS code 6,5	Version 0	Version 1	Version 2		
	Aircraft Operational Status Message	-	Aircraft Operational Status Message		
	CC		Subtype = 0		Subtype = 1
			Airborne Capability Class		Surface Capability Class
					Length/Width
			Airborne Operational Mode		Surface Operational Mode
			GVA		-
	OM		NIC _{BARO}		TRK/HDG
			Version Number		
			NIC Supplement-A		
			NAC _P , SIL		
			SIL Supplement		
			HRD		

As shown in the above table, all the versions of 1090 ES application involve the 7 basic registers (Airborne Position, Surface Position, ES Status, ES Identification and Category ES Airborne Velocity ES Event Driven Register and ES Aircraft Status). The remaining registers (BDS code 6,2, BDS code 6,3, BDS code 6,4) in the table have different definitions and applications for the three versions of 1090 ES application. Generally, for version 0, only five registers (BDS code 0,5, code 0,6, code 0,8, code 0,9 and BDS code 6,1) will be broadcast. In addition to the above five registers, version 1 will also broadcast message about BDS code 6,2 and code 6,3, while version 2 will broadcast message about BDS code 6,2 and code 6,5 additionally.

Table 7-3 ADS-B Message

Version	Common usage ADS-B Message
0,1,2	ES Airborne Position
	ES Surface Position
	ES Identification and Category
	ES Airborne Velocity
	ES Aircraft Status / Type Code=28
1,2	Target State and Status Information / BDS code 6,2/Type Code=29
1	Aircraft Operational Status / BDS code 6,3/Type Code=31 for version 1
2	Aircraft Operational Status /BDS code 6,5/Type Code=31 for version 2

*Mode S Downlink Aircraft Parameters
Implementation and Operations Guidance Document*

The three versions of the ADS-B application have different definitions of surveillance accuracy and the application of “event-driven” register messages. Therefore, the prerequisite for the correctly decoding the surveillance accuracy information and “event-driven” messages is the determination of the 1090 ES version.

There are two steps to check the ADS-B version, due to the fact that ADS-B version information in version 0 is not included in any message. **Step 1:** Check whether an aircraft is broadcasting ADS-B messages with Aircraft Operational Status message (Type Code=31) at all. If no message is ever reported, it is safe to assume that the version is equal to “0”. **Step 2:** If messages with Type Code =31 are received, check the version numbers located in the bits 41–43 in ME (or bits 73–75 in the message). The bits “001” correspond to version 1 and “010” to version 2 respectively.

7.4.3 ADS-B message Transmission Broadcast rate

The maximum ADS-B Message transmission rate shall not exceed 6.2 transmitted messages per second averaged over any 60 second interval. **There are periodic messages which are broadcast in the periodic manner and event-driven messages which are broadcast following the event-driven protocol. The event-driven protocol limits event-driven message transmissions to 2 per second in any second.**

a) **Airborne position Message (Version 0, 1, 2) is a periodic message, and** shall be emitted at random intervals that are uniformly distributed over the range from 0.4 to 0.6 seconds.

b) **Surface position Message (Version 0, 1, 2)** is a periodic message, and shall be emitted using one of two rates (high or low rate). The low rate is used when the aircraft is stationary, the high rate is used when the aircraft is moving. When the high squitter rate has been selected, the transmission interval of the surface position message obeys a uniform distribution within the interval of 0.4 to 0.6 seconds, and when the low squitter rate is used, it shall be emitted at random intervals that are uniformly distributed over the range of 4.8 to 5.2 seconds.

c) **Aircraft identification Message (Version 0, 1, 2) is a periodic message,** which transmission interval follows a uniform distribution over 4.8 to 5.2 seconds when the aircraft is reporting the airborne position message, or when the aircraft is reporting the surface position message at the high rate (moving). When the surface position message is being broadcasted at the low rate (stationary), the message shall be emitted at random intervals that are uniformly distributed over the range of 9.8 to 10.2 seconds.

d) **Airborne velocity Message ((Version 0, 1, 2) is a periodic message, and** shall be emitted at random intervals that are uniformly distributed over the range from 0.4 to 0.6 seconds.

e) **Target State and Status Message (Version 1, 2) is delivered using the event-driven protocol in version 1 and is periodic message in version 2, and** shall be initiated only when the aircraft is airborne and when target state (vertical or horizontal) information is available and valid. The TSS Message shall be broadcast at random intervals with the uniformly distributed over the range of 1.2 to 1.3 seconds.

f) **Aircraft Operational Status Message –Airborne is delivered using the event-driven protocol in version 1 and is periodic message in version 2, and** shall be emitted for a period of 24 seconds at random intervals that are uniformly distributed over the range of 0.7 to 0.9 seconds, when the Target State and Status (TSS) Message is not being broadcast and there has been a change within the past 24 seconds in the value of one or more of the specific parameters (*TCAS Operational/TCAS RA Active/NACP/SIL for Version 1 and TCAS RA Active/NACP/SIL/NIC_{SUPP} for Version 2*) included in the Operational Status Message.

*Mode S Downlink Aircraft Parameters
Implementation and Operations Guidance Document*

For other case when there is not any change within the past 24 seconds in the value of the specific parameters mentioned previous paragraph, the transmission interval of the message obeys a uniform distribution within the interval of 2.4 to 2.6 seconds

g) **Aircraft Operational Status Message –Surface is delivered using the event-driven protocol in version 1 and is periodic message in version 2, and** shall be always broadcast at random intervals that are uniformly distributed over the range of 4.8 to 5.2 seconds for **Version 1**. For **Version 2**, the Surface Aircraft Operational Status Messages shall be broadcast at random intervals that are uniformly distributed over the range of 4.8 to 5.2 when the aircraft is on-ground and not moving. If the Aircraft is moving and there has been no change in the specific parameters (*NIC_{SUPP} / NAC / SIL*) then the message shall be broadcast at random intervals that are uniformly distributed over the range of 2.4 to 2.6 seconds for Version 2. When the Version 2 aircraft is on-ground and moving and there has been a change in the parameters mentioned above then the message shall be broadcast at random intervals that are uniformly distributed over the range of 0.7 to 0.9 seconds.

h) **Extended Squitter Aircraft Status message (Version 0)** is an event-driven message, and shall be broadcast at random intervals that are uniformly distributed over the range of 0.8 to 1.2 seconds for the duration of the emergency condition (temporary or permanent). If the Mode A Code is changed to 7500, 7600 or 7700, the duration of emergency condition shall be permanent. If the Mode A Code is changed to any other value, the emergency condition shall be temporary, and duration is equal to 18 seconds (TC).

i) **Extended Squitter Aircraft Status message (Version 1) is an event-driven message, and the transmission rate varies depending on whether the TSS Message is not being broadcast, versus being broadcast.**

In the case where the TSS Message is not being broadcast, the Extended Squitter Aircraft Status message shall be broadcast at random intervals that are uniformly distributed over the range of 0.7 to 0.9 seconds for the duration of the emergency condition. It shall be broadcast at random intervals that are uniformly distributed over the range of 2.4 to 2.6 seconds for the duration of the emergency condition, when the TSS Message is being broadcast,

j) **Extended Squitter Aircraft Status message with Subtype=1 (Version 2)** is an event- driven message, and shall be broadcast at random intervals that are uniformly distributed over the range of 0.7 to 0.9 seconds for the duration of the emergency condition, or the Message shall not be broadcast (no emergency condition established), When the Mode A Code transmission is disabled (be set to Mode S Conspicuity Code “1000”).

When the Mode A Code transmission is enabled, the Aircraft Status message with Subtype=1 shall be broadcast at random intervals that are uniformly distributed over the range of 0.7 to 0.9 seconds for a duration of 24 ± 1 seconds following a Mode A Code change by the pilot

In the absence of conditions above for version 2, the Message shall be broadcast at random intervals that are uniformly distributed over the range of 4.8 to 5.2 seconds.

The Aircraft Status Message with Subtype=2 (TCAS RA Broadcast) for version 2 shall be broadcast at random intervals that are uniformly distributed over the range of 0.7 to 0.9 seconds. The transmission shall be terminated 24 ± 1 seconds after the *Resolution Advisory Termination* (RAT) flag transitions from ZERO (0) to ONE (1).

7.5 Application of the Mode S DAPs in ATM Automation System

7.5.1. Implementation of the General DAPs information

General DAPs information refers to the information that both Mode S SSR, MLAT and ADS-B can provide. This information from aircraft can be beneficial to the ATM automation system:

- a) ICAO 24-bit Aircraft Address/Aircraft Identification
 - 1) The ATM automation system should collect the real aircraft address/aircraft identification from the received message, and the aircraft address/aircraft identification can be shown on the control HMI to identify the aircraft.
 - 2) The ATM automation system can use the aircraft address/aircraft identification to correlate an aircraft's track with the flight plan, so the use of aircraft address/aircraft identity can alleviate the shortage of Mode 3/A code. Correlation between track and flight plans is normally based on either the 24-bit aircraft address, aircraft identification, or the Mode 3/A code. The correlation will depend on their weights and priority.
 - 3) The ATM automation system can also utilize the aircraft address/aircraft identification to improve the tracking function.
 - 4) The ATM automation system could provide DUPE warning between aircrafts which have the same ICAO 24-bit aircraft address, same aircraft identification or the same Mode 3/A code.

- b) Altitude reporting in 25ft interval

The ATM automation system can collect aircraft altitude reporting in 25ft increments and provides valuable improvements to the quality of safety nets. The improvements should reduce the number of nuisance alerts and enhance the integrity of separation assurance.

- c) Selected Altitude
 - 1) The ATM automation system can collect the selected altitude of the aircraft from Mode S SSR DAPs BDS 4,0 or ADS-B DAPs BDS 6,2 (Version 2) that can be shown to the controller to improve the situational awareness of the controller.
 - 2) The ATM automation system can generate a SFL Mismatch Alarm when the SFL chosen by the crew does not match the cleared altitude given by the controller (CFL), alerting the controller to take appropriate action to remedy the issue. A SFL Mismatch Alarm shall be presented to the responsible controller as an indication in the coupled/correlated surveillance track label and in the associated flight strip.
 - 3) The ATM automation system can also utilize the SFL to improve the accuracy of the safety net.

In MTCD function, the ATM automation system can use the selected altitude as the target climbing/descending altitude in the flight look-ahead time, and calculate the possibility of conflict with the predicted flight trajectories of other flights in the airspace through trajectory prediction. Calculations involving SFL could be more accurate, and improve the performance of MTCD.

In MSAW function, the ATM automation system generally provides MSAW warning by using track data (heading and rate of climb/descent and mode c). The ATMs use of CFL or SFL can enhance the MSAW algorithms use of vertical data to predict MSAW alerts and reduce the number of false alerts.

d) Barometric Pressure Setting

The ATM automation system can collect the barometric data of the aircraft from Mode S SSR DAPs BDS 4,0 or ADS-B DAPs BDS 6,2 (Version 2) and provide this information to the controller. The system can provide a warning when the barometric data transmitted by the aircraft does not match the parameter of the area where the aircraft is operating.

e) Ground Speed, True Track Angle, Magnetic Heading, True Airspeed

- 1) The ATM automation system can collect Ground Speed, True Track Angle from Mode S SSR DAPs BDS 4,0 or ADS-B DAPs BDS 0,9 and 0,6, True Airspeed from Mode S SSR DAPs BDS 5,0 or ADS-B DAPs BDS 0,9 (if ground speed is unavailable), Magnetic Heading from Mode S SSR DAPs BDS 6,0 or ADS-B DAPs BDS 0,9 (if ground speed is unavailable). The system may provide the display of some of the information to the controller to improve the situational awareness of the controller. This information can be displayed in various ways (e.g., a DAP Window) as offline defined, according to the requirement of the controllers. Display of some parameters provides a clearer picture to the controllers generating a reduction in radio calls with the pilot, so the R/T usage between the controller and individual aircraft under service is reduced.
- 2) The system can make use of DAPs kinematics parameters for consistency checking, and perform a more precise tracking function.
- 3) The system can utilize the kinematics information of the aircraft to improve the accuracy of safety net functions, (e.g., Short-Term Conflict Alert (STCA)), through the provision of more accurate aircraft tracks.
- 4) The system may use True track angle, Magnetic Heading, True Airspeed and Ground Speed to calculate a wind direction and speed of a specific area, which will enable the updating of forecast winds and improve trajectory modeling in the system. The system may also show the wind information to the controller to improve the situational awareness of the controller.

f) Barometric Altitude Rate

The ATM automation system can collect the vertical rate data of the aircraft from Mode S SSR DAPs BDS 4,0 or ADS-B DAPs BDS 0,9 to improve the precision of the compute altitude and the accuracy of the related alert. The system can make use of the data to realize an optimized CFL protection in STCA and MSAW analysis function.

g) Indicated Air Speed

The ATM automation system can acquire indicated airspeed of the aircraft from Mode S SSR DAPs BDS 6,0 or ADS-B DAPs BDS 0,9 (if ground speed is unavailable), allow ATC to monitor the aircrew compliance with the controller's instructions, and if required provide a warning to the controller when there is a mismatch.

h) ACAS Resolution Advisory Report

Some of the ATM automation system can collect the ACAS Resolution Advisory Report from Mode S SSR DAPs BDS 3,0 or ADS-B DAPs BDS 6,5 (Version 2). The ACAS Resolution Advisory information can be shown in the system to improve situational awareness of the controller. On receipt of ACAS Resolution Advisory notification, a prominent notification is displayed in a field that may be acknowledged. The indication is removed when the ACAS RA is resolved.

Note: The display of ACAS Resolution Advisory Report in ATM automation system can be turned on or turned off by a user, and it's use if not recommended by IFATCA. The user is suggested to do the relevant safety evaluation before applying this function.

7.5.2. Mode S SSR DAPs

Mode S SSR DAPs information refers to the information that only Mode S SSR can provide. This following information of aircraft can be beneficial to the ATM automation system:

a) Roll Angle, Track Angle Rate,

- 1) The ATM automation system can collect these parameters from Mode S SSR DAPs BDS 5,0 and may allow the display of some of the information to the controller to improve the situational awareness of the controller. This information can be displayed in various ways (e.g., a DAP Window) as offline defined, according to the requirement of the controllers. Display of some parameters provides a clearer picture to the controllers generating a reduction in radio calls with the pilot, so the R/T usage between the controller and individual aircraft under service is reduced.
- 2) The system can make use of DAPs kinematics parameters for consistency checking, and perform a more precise tracking function.
- 3) The system can utilize the kinematics information of the aircraft to improve the accuracy of safety net functions, (e.g., Short-Term Conflict Alert (STCA)), through the provision of more accurate aircraft tracks.
- 4) The system may use True track angle, Magnetic Heading, True Airspeed and Ground Speed to calculate a wind direction and speed of a specific area, which will enable the updating of forecast winds and improve trajectory modeling in the system. The system may also show the wind information to the controller to improve the situational awareness of the controller.

b) Inertial Vertical Velocity

The ATM automation system can acquire the vertical rate data of the aircraft from Mode S SSR DAPs BDS 6,0 to improve the precision of the compute altitude and the accuracy of the related alert. The system can make use of the data to realize an optimized CFL protection in STCA and MSAW analysis function.

c) Mach Number

The ATM automation system can acquire Mach number of the aircraft from Mode S SSR DAPs BDS 6,0. This information can allow ATC to monitor the aircrew compliance with the controller's instructions, and if required provide a warning to the controller when there is a mismatch.

d) Flight status (airborne/on the ground)

The ATM automation system can collect the flight status of the aircraft from reply of the Mode S SSR Roll-Call interrogation. Whether the aircraft is airborne or on the ground can be shown in the system to improve the situational awareness of the controller. Also, the flight status can be used to filter the aircraft on the ground in the system if necessary.

7.5.3. ADS-B DAPs

a) Aircraft emitter category

The emitter category can be acquired from ADS-B DAPs BDS 0,8 can be provided information about the type of vehicle to the controller by the ATM automatic system. The system can provide a warning to the controller when the information transmitted by the aircraft does not match the Flight Plan.

- b) GNSS information (latitude, longitude, height, altitude, velocity, vertical rate, accuracy and integrity of GNSS information)
- 1) The precision of aircraft position in GNSS information should be higher than normal radars. The ATM automation can make use of DAPs GNSS information to perform a more precise tracking function.
 - 2) The ATM automation system can utilize the GNSS information in different ways or display in different symbols to the controller based on the accuracy and integrity values of current GNSS information received in the messages.
 - 3) In order to meet the requirements of ICAO Annex 6 and Annex 10 for aircraft RVSM altitude maintenance performance monitoring, the geometric altitude in ADS-B (using as the real altitude of aircraft operation), can be compared with the air pressure altitude (Mode C) to analyzes the aircraft altitude keeping performance. The comparison verifies whether the aircraft is flying according to the selected altitude setting by the crew, and validates the continual compliance for RVSM altitude monitoring.
 - 4) Airborne horizontal position/Geometric altitude can be used in data analysis. Based on flight trajectory, an analyzer can classify different trajectory models, view different traffic pattern, find abnormal trajectory, analyze the operation efficiency of traffic flow, and predict the flight time of future trajectory.
- c) Selected Heading/Target Heading
- 1) The ATM automation system can use the selected heading/target heading of the aircraft, and may display the information to the controller to improve the situational awareness of the controller.
 - 2) The ATM automation system can generate a heading Mismatch Alarm when the selected heading/target heading does not match the heading given by the controller, alerting the controller to take appropriate action to remedy the issue.
 - 3) The ATM automation system can also utilize the selected heading/target heading to improve the accuracy of the safety net.

7.6 Flight Planning

7.6.1 ICAO Flight Plan Item 7 - Aircraft Identification

ACID must be accurately recorded in item 7 of the ICAO Flight Plan form as per the following instructions:

Aircraft Identification, not exceeding 7 alphanumeric characters and without hyphens or symbols is to be entered both in item 7 of the flight plan and replicated exactly when set in the aircraft (for transmission as Flight ID) as follows:

Either,

- a) The ICAO designator for the aircraft operating agency followed by the flight identification (e.g., KLM511, NGA213, JTR25), when in radiotelephony the call sign to be used by the aircraft will consist of the ICAO telephony designator for the operating agency followed by the flight identification (e.g., KLM 511, NIGERIA213, JESTER25).

Or,

*Mode S Downlink Aircraft Parameters
Implementation and Operations Guidance Document*

- b) The nationality or common mark registration marking of the aircraft (e.g., EIAKO, 4XBCD, N2567GA), when:
- 1) in radiotelephony the callsign used by the aircraft will consist of this identification alone (e.g., CGAJS), or preceded by the ICAO telephony designator for the operating agency (e.g., BLIZZARD CGAJS),
 - 2) the aircraft is not equipped with a radio.

Note 1: No zeros, hyphens, dashes or spaces are to be added when the Aircraft Identification consists of less than 7 characters.

Note 2: Appendix 2 to ICAO DOC4444 (PANS-ATM 16th edition, 2016) refers.

Note 3: Standards for nationality, common and registration marks to be used are contained in Annex 7, section 3.

Note 4: Provisions for the use of radiotelephony call signs are contained in Annex 10, Volume II, Chapter 5. ICAO designators and telephony designators for aircraft operating agencies are contained in Doc 8585 — Designators for Aircraft Operating Agencies, Aeronautical Authorities and Services.

7.6.2 Equipment (Surveillance Equipment /SSR Equipment)

- a) ICAO Flight Plan Item 10 – Surveillance Equipment and Capabilities

When an aircraft is equipped with a Mode S Transponder, appropriate Mode S designators shall be entered in item 10 of the flight plan to indicate that the flight is capable of transmitting Mode S DAPs messages.

These are defined in ICAO DOC 4444 as follows:

‘N’ No surveillance equipment for the route to be flown is carried, or the equipment is unserviceable

SSR Mode A and C

‘A’ Mode A transponder

‘C’ Mode A and Mode C transponder

SSR Mode S

‘E’ Mode S transponder, including aircraft identification, pressure-altitude and extended squitter (ADS-B) capability

‘H’ Mode S transponder, including aircraft identification, pressure-altitude and enhanced surveillance capability

‘I’ Mode S transponder, including aircraft identification, but no pressure-altitude capability

‘L’ Mode S transponder, including aircraft identification, pressure-altitude, extended squitter (ADS-B) and enhanced surveillance capability

‘P’ Mode S transponder, including pressure-altitude, but no aircraft identification capability

‘S’ Mode S transponder, including both pressure altitude and aircraft identification capability

‘X’ Mode S transponder with neither aircraft identification nor pressure-altitude capability

*Mode S Downlink Aircraft Parameters
Implementation and Operations Guidance Document*

Note: Enhanced surveillance capability is the ability of the aircraft to down-link aircraft derived data via a Mode S transponder.

b) ICAO Flight Plan Item 18 – Other Information

Where required by the appropriate authority the ICAO AA (24 Bit Code) may be recorded in Item 18 of the ICAO flight plan, in hexadecimal format as per the following example:

CODE/7C432B

Members or states should note that use of hexadecimal code may be prone to human error and is less flexible in regard to airframe changes for a notified flight.

7.6.3 Inconsistency between Mode S Flight Planning and Surveillance Capability

Inconsistency between flight planning of Mode S and surveillance capability of an aircraft can impact ATC planning and situational awareness. States are encouraged to monitor for consistency between flight plan indicators and actual surveillance capability. Where discrepancies are identified aircraft operators should be contacted and instructed to correct flight plans, or general advice (as appropriate to the operational environment and type of flight planning problems) should be issued to aircraft operators.

Advice to Operators:

Concerning inconsistency between Mode S Flight Planning and Surveillance Capability:

- a) ICAO AA (24 Bit Code) not submitted, or submitted incorrectly.
- b) Mode S and surveillance capabilities indicators incorrectly.

The flight planning requirements and relevant designators for aircraft are described in local document reference or ICAO DOC 4444 Appendix 2. The capability of the aircraft transponder and ADS-B capability will typically be available in the transponder manual or the aircraft flight manual for the aircraft. If in doubt, consult the transponder manual, aircraft flight manual or the Licensed Aircraft Maintenance Engineer.

7.6.4 Setting Flight ID in Cockpits

a) Flight ID Principles

The Flight ID is the equivalent of the aircraft callsign and is used in both Mode S SSR and ADS-B technology. Up to seven characters long, it is usually set in airline aircraft by the flight crew via a cockpit interface. It enables air traffic controllers to identify an aircraft on a display and to correlate a radar or ADS-B track with the filed flight plan ACID. Flight ID is critical, so it must be entered carefully. Punching in the wrong characters can lead to ATC confusing one aircraft with another.

The Flight ID entered in the transponder exactly must match the ACID entered in the flight plan.

Intuitive correlation between an aircraft's flight identification and radio callsign enhances situational awareness and communication. Airlines typically use a three letter ICAO airline code in flight plans, NOT the two letter IATA codes.

b) Setting Flight ID

The callsign dictates the applicable option below for setting Mode S or ADS-B Flight ID:

*Mode S Downlink Aircraft Parameters
Implementation and Operations Guidance Document*

- 1) The flight number using the ICAO three-letter designator for the aircraft operator if a flight number callsign is being used (e.g., QFA1 for Qantas 1, THA54 for Thai 54).
- 2) The nationality and registration mark (without hyphen) of the aircraft if the callsign is the full version of the registration (e.g., VHABC for international operations).
- 3) The registration mark alone of the aircraft if the callsign is the abbreviated version of the registration (e.g., ABC for domestic operations).
- 4) The designator corresponding to a particular callsign approved by the ANSP or regulator (e.g., SPTR13 for firespotter 13).
- 5) The designator corresponding to a particular callsign in accordance with the operations manual of the relevant recreational aircraft administrative organization (e.g., G123 for Gyroplane 123).

Note: More information of Flight plan for 1090 MHz ADS-B can refer to section 9.10 of AIGD.

7.7 Contingency Plan

ANSPs should prepare appropriate contingency plans in the event of a system failure that prevents the use of Mode S DAPs.

8. TRAINING AND COMPETENCY

8.1 Introduction

Training and development play an important role in the effectiveness of organizations and to the experiences of people in work. Training on DAPs has implications in improving productivity, aviation safety and personal development. The primary goal of the training is to develop and maintain an appropriate level of trust in DAPs related module, i.e., to make ATC and ATSEP aware of the likely situations where DAPs will be effective and, more importantly, situations in which DAPs will not be so effective (e.g., sudden, unexpected maneuvers).

8.2 Training of an Air Traffic Controller (ATC) in DAPs

With the inclusion of DAPs into surveillance and ATM automation system, an ATC training plan should adopt a modular approach. This approach progressively introduces various features, functionality of the new system on one hand and allows for integration with the ATC operational procedures. Additional benefits include shorter, logical self-contained units, clear attainable goals, better evaluation of training effectiveness and simplified self-assessment.

The ANSP should develop familiarization and rating focused training to ATC prior to adoption of DAPs in Surveillance and ATM automation systems.

The ANSP should ensure that all ATC concerned are assessed as competent for the use of the relevant DAPs module.

8.3 Training of an ATSEP in DAPs

- a) The ANSP should develop an ATSEP training programme that is acceptable to the ANS Regulator prior to its implementation.
- b) As a minimum, the training programme should comprise three levels as described below:
 - 1) Level 1 (Basic training). This should comprise training on the basic Surveillance and ATM automation systems operating in the State and their impacts on the safety of aircraft operations. The ANSP should ensure every ATSEP undergoes the basic training.
 - 2) Level 2 (Qualification training). This should comprise training to develop knowledge and skills on Surveillance and ATM automation systems. The ANSP should ensure each ATSEP is trained in one or more domains depending on their job scope.
 - 3) Level 3 (Specialized training). This should comprise training on specific Surveillance and ATM automation systems installed in the State, followed by on-the-job training.
- c) The ANSP should conduct a yearly review of the training plan for each ATSEP at the beginning of the year to identify any gaps in competency or changes in training requirements and priorities the type of training required for the coming year in regards of DAPs development.
- d) The ANSP should keep records of individual ATSEP training, competency assessment and approval history, where applicable, and associated documents. The records should be kept at least until the Surveillance and ATM automation system of which the ATSEP was trained on is no longer in use with the ANSP.

- e) The individual training records for each of ATSEP should include a training plan detailing the courses completed as well as the time-frame for attending future courses as required under his/her training plan.

8.4 Competency Assessment of an ATSEP in DAPs

- a) The ANSP should develop an assessment methodology to determine the competency of an ATSEP in accordance with the competency framework developed in PANS-Training and which should be adapted to suit the local context.
- b) The ANSP may select a person to be a competency assessor only if the person –
 - 1) is an ATSEP approved in accordance with paragraph 8.3 for the particular Surveillance and ATM automation system; and
 - 2) has received adequate training in the conduct of competency assessment, practical checks and oral questionings.
- c) A competency assessor should not conduct a competency assessment on an ATSEP who is under the direct supervision of the competency assessor unless the assessment is done in the presence of a second independent assessor.
- d) The assessment methodology should include a process for on-going competency checking and refresher training to ensure retention of competence.

9. SPECIFIC EXAMPLES ON MODE S DAPs APPLICATION

9.1 Use of Selected Altitude

Since August 2013, Mode S data processing functions have been implemented in Chengdu ATM automation system. The system uses the select altitude data extracted from the Mode S DAPs to provide an optimized CLAM alert for controllers. The system will generate the alert when the SFL chosen by the crew does not match the cleared altitude recorded in the ATM automation system. And a time delay parameter is predefined for the response time of the flight after controllers' input to the ATM automation system (typically at the time of instruction given to the pilot).

Thanks to this new kind of alert, controllers have a better awareness of the intention of the airplanes and may discover the crew's mis-operation much earlier than the traditional CLAM, and then take actions timely to avoid the potential conflict.

In April 2017, an A320 aircraft was maintaining level flight at 27600 feet with another flight flying nearby at 26600 feet. Suddenly, the crew set an error altitude 22600 feet. The ATM automation system triggered the alert immediately even before the aircraft began to descend. The controller quickly noticed the alert and informed the crew in time. The aircraft successfully stopped descend at 27400 feet.

9.2 Use of ACAS RA

With the advancement of the ASTERIX standards and DAPs application, an ATM system can handle the derived data from Aircraft, which is detected, received and transmitted through the Mode S Radar, ADS-B station, and WAM sensors. In the event that an Airborne Collision Avoidance System (ACAS) Resolution Advisory (RA), the ATM system is able to provide a visual and aural alarm warning and indicative pilot intention to the controller.

Resolution Advisory (RA) alerting function works as follows:

- A resolution advisory is present when, in the subfields I048/260, I020/260, I021/260, I021/260 or I062/380 subfield #12(ACS), the bits are set as follows:
 - the first bit of the ARA field set to 1 and the RAT bit set to 0 or,
 - the first bit of the ARA field set to 0, the MTE bit set to 1 and the RAT bit set to 0.
- A resolution advisory is removed when:

*Mode S Downlink Aircraft Parameters
Implementation and Operations Guidance Document*

- the ACAS RA report subfield (I048/260, I020/260, I021/260 or I062/380 subfield #12(ACS)) contains the RAT bit set to 1, or
- An ACAS RA report is not received in the relevant Data Item of the ASTERIX report.

Besides, the Resolution Advisory Intention is populated base on the PILOT selection and according to the following table:

MTE (60)	ARA (41)	42	43	44	45	46	47	RA Selection	RA Intention
1	0	Any	0	Any	1	Any	Any	Descend	Positive descend (Descent to avoid the threat)
1	0	Any	1	Any	0	Any	Any	Climb	Positive climb (Climb to avoid the threat)
1	0	Any	0	Any	0	Any	Any	Other	Other

*NOTE1: ACAS Airborne Collision Avoidance System, applied in the EURO Aviation System, has the same meaning as TCAS abbreviated to Traffic Alert and Collision Avoidance System in the USA Aviation System

*NOTE2: The function and the matters needing attention related to ACAS Resolution Advisory Report in ATM automation system, please refer to 7.4.1 e).

9.3 Use of Mode-S DAPs data for weather forecast

Meteorological Research Institute (MRI) and Electronic Navigation Research Institute (ENRI) conducted experiments for improving weather forecast accuracy utilizing Mode S DAPs data. In the experiments, horizontal wind and temperature were estimated from the data in registers BDS code 5,0 and BDS code 6,0 listed below.

Table 9-1 DAPs information for weather forecast

Register	Name	Data Item
BDS code 5,0	Track and turn report	True Track Angle
		Ground Speed

*Mode S Downlink Aircraft Parameters
Implementation and Operations Guidance Document*

		True Airspeed
BDS code 6,0	Heading and speed report	Magnetic Heading
		Mach Number

The temperature is the function of Mach number and true airspeed. To estimate horizontal wind speed and direction, calculating zonal wind speed and meridional wind speed from ground speed, true airspeed, true track angle and true heading angle. The true heading angle is obtained from magnetic heading angle and magnetic declination which is given by a quadratic equation of aircraft position. Then the wind and temperature as observation data were used to produce the initial fields of the numerical model, resulting in the improvements of weather forecast accuracy.

The results of the experiments indicate that Mode S DAPs data have the potential to improve forecasts of rainfalls and shear-lines. For details, please refer to the IP11 presented by Japan at the Mode S DAPs/3.

9.4 Use of Barometric Pressure Setting

When the aircraft is below the transition level the pilot is required to set barometric pressure setting in altimeter to local QNH/QFE. Wrong barometric pressure setting (especially QNH higher than actual) can lead to cleared flight level deviation or more serious controlled flight into terrain, as the pilot sees higher altitude on his altimeter and the flight management system determines the lower target altitude base on barometric pressure setting and selected altitude. Every millibar of barometric pressure setting error may add 30 feet of error to altimeter and target altitude.

Constantly checking if the barometric pressure setting in DAPs is consistent with the airport's QNH can alert the controller to avoid similar situations. In Feb 2021, an aircraft was cleared to descend to 7000 feet. The pilot set the right selected altitude, but forgot to set barometric pressure setting. At that time, the airport QNH was 1013, while the crew barometric pressure setting was 1118.5. An alarm system notified the controller of this situation. The error was corrected after the controller prompted the pilot preventing a dangerous situation.

9.5 Application of geometric height of ADS-B in analysis of Height-Keeping-Performance in RVSM

TVE, AAD and ASE are important indicators reflecting the height keeping performance of aircraft, which can be calculated based on ADS-B data, the definitions of TVE, AAD, ASE and FTE in Doc 9574 are as followed:

***Total vertical error (TVE).** The vertical geometric difference between the actual pressure altitude flown by an aircraft and its assigned pressure altitude (flight level).*

Assigned altitude deviation (AAD). The difference between the transponder Mode C altitude and the assigned altitude/flight level.

Altimetry system error (ASE). The difference between the altitude indicated by the altimeter display, assuming a correct altimeter barometric setting, and the pressure altitude corresponding to the undisturbed ambient pressure.

Flight technical error (FTE). The difference between the altitude indicated by the altimeter display used to control the aircraft and the assigned altitude/flight level.

The section 4.10 of Appendix A of Doc 9574 outlines the method for estimating ASE. The description is as followed:

An aircraft's actual ASE at any time is the difference between its actual TVE and contemporaneous actual FTE. Given a measure of TVE and a contemporaneous AAD for the aircraft, the difference between TVE and AAD provides an estimate of ASE.

Figure 9-1 shows the relationship between the vertical errors. As noted in Doc 9574, correspondence error can be negligible when estimating ASE, so RMAs only estimates TVE, AAD and AES usually.

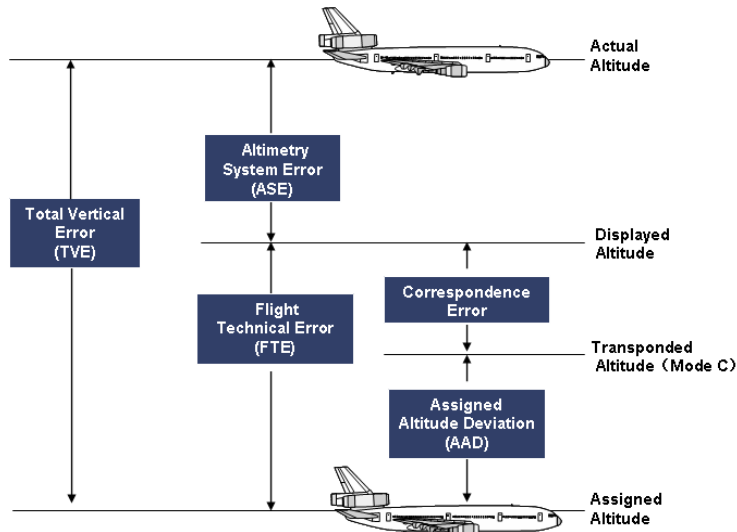

Figure 9-1: Relationship between the vertical errors

Figure 9-2 shows the calculation process of TVE, AAD and ASE based on ADS-B data. It should be known that the aircraft actual geometric altitude and Mode C pressure altitude are included in ADS-B data. For assigned pressure altitude, it can be inferred from Mode C pressure altitude. And for the corresponding geometric altitude, it can be calculated by combining the inferred assigned pressure altitude/FL and the MET data. The difference between aircraft actual geometric altitude and geometric altitude of the inferred assigned pressure altitude/FL is TVE, the difference between inferred assigned pressure altitude/FL and Mode C pressure altitude is AAD, and the difference between TVE and AAD is ASE.

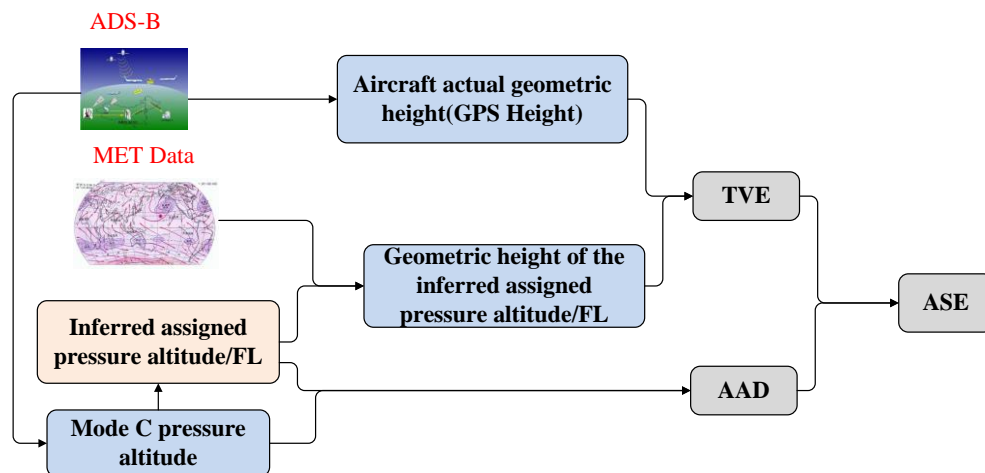

Figure 9-2: Calculation process of TVE, AAD and ASE based on ADS-B

In 9574, the error ranges of TVE, AAD and ASE are defined at the same time

- 1) $TVE \geq 90 \text{ m (300 ft)}$.
- 2) $ASE \geq 75 \text{ m (245 ft)}$; and
- 3) $AAD \geq 90 \text{ m (300 ft)}$.

APPENDIX 1: Mode S DAPs Analysis

a) Data Recording Configuration

Figure 1 represents an example of a configuration for data recording. The Mode S sensor sends interrogations to an individual aircraft using a unique ICAO 24-bit aircraft address. The Mode S transponder has 255 BDS Registers. Each register stores aircraft parameters data derived from FMS or other sensors. The messages can be readout on demand by a ground interrogator, in addition to/or being broadcasted.

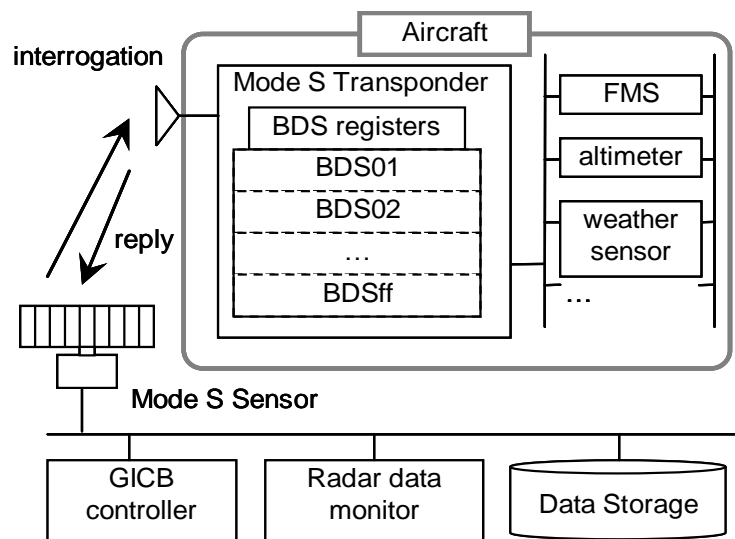

Figure1 - Example of Data Recording Configuration

b) Data Analysis

As described above section, erroneous DAPs data have been observed due to failure or improper setting/installation of Mode S avionics equipment. Bad data hinders the use of DAPs by the ATM service. To employ DAPs for ATM services, the reliability of DAPs is important. Therefore, it is necessary to analyze the recorded data to ensure reliability of the DAPs data.

If a controller finds some problem during the application of the Mode S DAPs, the ATS providers can analyze the recorded data to find the exact reason which caused the problem. If the ATS equipment has a fault which caused the problem, the ATS provider should implement a solution as soon as possible. If the ATS

*Mode S Downlink Aircraft Parameters
Implementation and Operations Guidance Document*

provider proves that the problem is caused by an avionics fault, then the problem should be reported to the appropriate party to solve the problem. The ATS providers need to devise mechanisms and procedures to address identified faults.

ATS providers should develop systems to analyze the routine recorded data. From the analyses, ATS providers can provide more information of the transponder’s performance such as SI capability, datalink capability etc. The information can be used to improve the capability of the operation of Mode S DAPs equipment. By analyzing the recorded data, advice on avionics anomalies and faults, which have been detected, can be passed onto the regulators and the aircraft operators.

c) DAPs Data Validation

To ensure that Mode S DAPs are operating in conformance with the ICAO requirements, validating DAPs data is highly recommended. It has been noted that there are some drawbacks in the traditional methodology of executing tests for aircraft on the ground as follows:

- 1) Avionics for DAPs consist of several devices and functional blocks. They are interconnected, and the configuration is complicated.
- 2) Avionics and configuration differ depending on each aircraft.
- 3) It is difficult to cover the possible test patterns completely.
- 4) Ground test methodology would not detect failures or anomalies that occur after the testing.

Responding to these drawbacks, MIT Lincoln Laboratory developed and proposed a DAPs validation methodology, which monitors DAPs data received from actual flying aircraft to detect erroneous data. The MIT validation methodology is mainly categorized by two groups, static value tests and dynamic value tests.

Static value tests are executed to detect erroneous values of the bits and fields in BDS registers which do not change during a flight. Those bits and fields represent the avionics system’s configuration, capability, and status information. These tests verify that those bits and fields are proper values in compliance with the ICAO regulations for DAPs applications. Table 1 shows an example of static value tests. As can be seen by the table, failed data were detected in each BDS register test. For BDS Register 20₁₆, failed data with wrong character coding were caused not due to equipment problem, but to faulty data input.

Table 1 Example of Static Value Tests

BDS Register	Test Item	Total Count		Aircraft	
		Executed	Failed	Executed	Failed

*Mode S Downlink Aircraft Parameters
Implementation and Operations Guidance Document*

BDS code 1,0	Aircraft identification capability flag = '1'	544,980	7,183	3,615	146
BDS code 2,0	Each character conforms to ICAO 6-bit character coding	737,993	1,516	3,596	144
BDS code 4,0	Unavailable data fields are set at zero	54,248,802	1,755	3,614	4

Dynamic value tests validate the values which dynamically change according to aircraft motion, such as aircraft speed and track angle. The tests compare the DAPs values with equivalent data like radar-measured positions. If the difference between DAPs values and radar-derived parameters exceeds the acceptability threshold, the DAPs value is accounted as an error. Figure 2 represents an example of dynamic value tests. This figure indicates that ground speed differences between DAPs data and radar-derived data fall inside the threshold range.

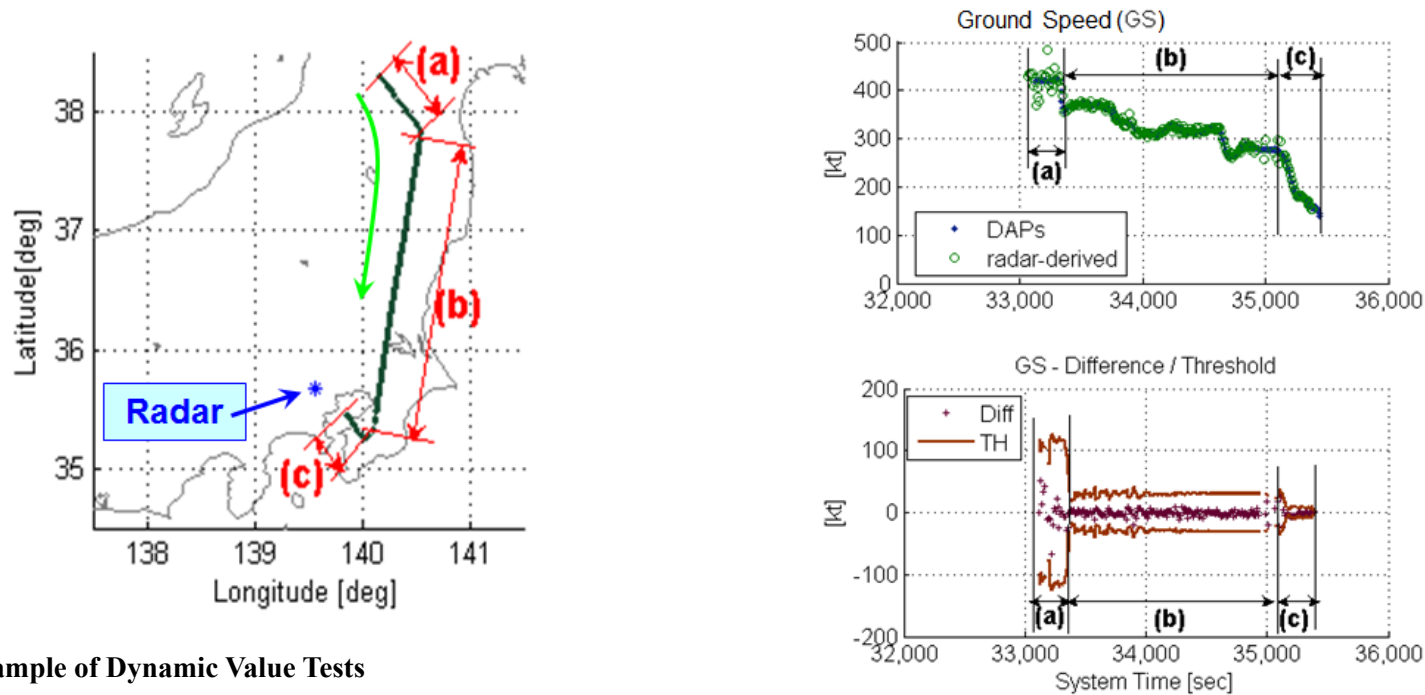

Figure 2 - Example of Dynamic Value Tests

APPENDIX 2: LIST OF IDENTIFIED ISSUES

Ref.	Issue	Cause	Safety Implications to ATC (Yes / No)	Recommendations
1.	Wrong ground bits in DAPs led to the track decoupling from the flight plan	Through joint investigation with the airlines, it found that parts of the aircraft A were exchanged with another aircraft B for test. The malfunction part was discovered when the wrong ground bits data was found coming from the aircraft B.	Yes The wrong ground bits in DAPs could make ATM automation system display track decoupled with flight plan	
2.	Wrong aircraft identification	Many cases of wrong aircraft identification were found at the beginning of mode S operation. All related data collected and sent to the relevant airlines by the management department. Through joint investigation with the airlines, it was found that the issue is normally due to pilot's error.	Yes Wrong aircraft identification could lead to wrong flight plan coupling.	Through the joint efforts of ATMB and the airlines, the aircraft identification data became more and more accurate.
3.	Wrong Barometric Pressure	Barometric Pressure, such as BARO or QNH, is available in Mode S BDS code 4,0. Initial testing found that data above the transition level for some aircraft types would not be useful due to a mismatch between what the crew set in the cockpit, and what the aircraft Downlinked.	Yes There will display a wrong Barometric Pressure with aircraft in ATM automation system.	EASA Safety Information Bulletin SIB-2016-05R2 ("Incorrect Downlink Barometric Pressure Settings") covers this issue.
4.	Different processing between Mode A/C and Mode S Altitude	Currently, the altitude accuracy of Mode A/C radar is 100ft, while that of Mode S radar is 25ft. The altitude tracking, and display mechanism of ATM automation systems could be received both precisions altitude data.	Yes In Mode S radar and Mode, A/C radar overlapped area, the ATM automation systems might display an altitude jumping.	The altitude tracking, and display mechanism of ATM automation systems need to be optimized to avoid altitude jumping.

*Mode S Downlink Aircraft Parameters
Implementation and Operations Guidance Document*

5.	<p>Mode S interrogators request the aircraft transponder registers too frequently in busy airspace</p>	<p>If Mode S interrogators request the aircraft transponder registers too frequently in busy airspace, it may appear that the transponder registers information cannot complete the whole transmission process. The BDS parameters requesting rule needs to be set by the Mode S interrogator reasonably.</p>	<p>Yes ATM automation system would display track delay or intermittent interruption of radar data.</p>	<p>The data transmission rate of Mode S radar to feed ATM automation system needs to be selected reasonably to meet the requirements of ATC operations in busy airspace to prevent track delay or intermittent interruption of radar data.</p>
6.	<p>Mode S DAPs data does not correspond to the content of the requested register</p>	<p>It has been noted that from time to time Mode S DAPs data does not correspond to the content of the requested register. For example, the content of BDS code 5,0 is received when extracting BDS code 4,0. This phenomenon is called “BDS swap”.</p> <p>Table 1 represents an example data of BDS swap. The table shows the data of BDS code 0,5/4,0/5,0 data downlink from an aircraft in three sequential scans. As can be seen by the table, BDS swap occurred at 08:05:45.</p>	<p>Yes Wrong information could display to controller.</p>	<p>Different options can be implemented to decrease the impact of such as:</p> <ol style="list-style-type: none"> 1. limit the number of radars extracting aircraft registers 2. implement specific filters in radar or in the surveillance data processing to discard the erroneous data (e.g. when two different registers are received with the same content they are both discarded)

*Mode S Downlink Aircraft Parameters
Implementation and Operations Guidance Document*

7.	Duplicated aircraft address	<p>One case was related to a local airline, wrong spare parts of the airplane were installed by mistake during maintenance. The airline replaced the spare parts after being informed. Another case was military aircraft.</p> <p>Another reason has been observed that in many cases the 24-bit aircraft address transmitted by the aircraft does not match its nationality (i.e. its State of Registry's block) or is otherwise incorrectly configured in the transponder. Care needs to be taken to ensure that the registration and the 24-bit address of every aircraft are processed and assigned simultaneously by the regulatory authority, and reporting mechanisms are in place to rectify incorrect configurations.</p>	<p>Yes</p> <p>The possible consequences are as follows:</p> <ol style="list-style-type: none"> 1. An aircraft may be locked out in error, if it is the same beam. This may result in a new aircraft not being detected when it enters Mode S radar coverage. 2. Possible track label swap for crossing aircraft, this may result in incorrect labeling of an aircraft on the Radar screen. 3. In the technical operation of Mode S Elementary surveillance, duplicated address may result in the possible loss of a track when the two aircraft are crossing due to the interrogation scheduling within the ground station. 	<p>According to Annex 10, the aviation authority of each State is responsible for assigning 24-bit addresses to all aircraft in its registry using the block allocated by ICAO to that State.</p> <p>The duplicate address should be detected and reported. Without duplicate address detection, if an aircraft enters the range of the Mode S SSR with the same ICAO 24-bit address as that of an existing target, the information of the new aircraft could be erroneously associated with the existing target.</p> <p>Once the Mode S DAPs System detect more than one aircraft is transmitting the same ICAO 24-address, it will initiate a duplicate address report and a duplicate address condition shall be declared, and when receive new information of this address, the system should associate the information by ID or position but not the address.</p>
8.	incorrect aircraft address in flight plan	<p>Although the overwhelming majority aircrafts are equipped with Mode S transponders, many flight plans are not filed with the correct aircraft address in item 18.</p>	<p>Yes</p> <p>This affects the function of aircraft address correlation in ATM automation system.</p>	

SURICG/7
Appendix A to WP/03

*Mode S Downlink Aircraft Parameters
Implementation and Operations Guidance Document*

9.	incorrect wind speed and direction	Aircrew round the system output figures from Spot Wind data was the main reason for variations by crew response. e.g. Recorded wind 283/42kts, crew response 280/40kts.	No	
10.	empty ACAS RA message	ASTERIX message “I048/260, ACAS Resolution Advisory Report” indicates that airplane is in ACAS RA condition. In some cases, all zero I048/260 reports are received in the ATM automation system through Mode S radar.	Yes ATM automation system may generate false ACAS alarm from Empty RA message.	ACAS message handling feature at ATM system must be checked on at its installation stage following the ACAS message flow
11.	erroneous SFL information	It is noticed ATM automation system could receive erroneous SFL information due to the BDS swap problem and other reasons.	Yes ATM automation system may generate false SFL mismatch alarm due to the erroneous SFL information.	ATM automation system could use multiple data sources to check the SFL data.
12.	Incorrect ACAS RA information	Many cases of incorrect ACAS RA information were found at the Mode S operation. After analysis the incorrect ACAS RA data, the reason is so called “BDS Swap” and only the old type of Mode S radar has the “BDS Swap” problem.	Yes Wrong information could display to controller.	Short term solution: Reject data (BDS content and/or reply) in case of difference between UF and DF. Reject BDS content (BDS 1,0; 2,0 and 3,0) in case of first byte error. Medium /long term solution: "Overlay" function is introduced in the fifth edition of Volume IV of ICAO document annex 10. the DP (data parity) field is designed to replace the AP field to check the BDS register number in the downlink DF20 / 21. It aims to solve BDS swap problem from the source.

*Mode S Downlink Aircraft Parameters
Implementation and Operations Guidance Document*

Table 1 Example Data of BDS Swap

BDS Register	Time of Scan		
	08:05:35	08:05:45 (BDS swap occurred)	08:05:55
BDS code 0,5	605f80c056966f	a3280030a40000	605f845303ce8d
BDS code 4,0	a3280030a40000	a3280030a40000	a3280030a40000
BDS code 5,0	fff8cf1f800489	a3280030a40000	ffb8cf1f80048a

APPENDIX 3: A Brief Introduction of Mode S SSR DAPs Data Source

1. Introduction

1.1 During the 2nd meeting of ICAO APAC Mode S DAPs WG, China presented an information paper regarding the Mode S DAPs data source, the meeting was of the view that the content of the paper will help in the understanding of the basic mechanism of avionics relevant to surveillance application and implementation of DAPs.

-Refer to Mode S DAPs WG/2 IP05 “Preliminary Study of DAPs Data Sources”

1.2 The Mode S DAPs provides useful information on aircraft that will enhance ATM operations. More attention should be paid when introducing Mode S DAPs and it’s important to clearly understand what these parameters are and where these parameters come from. This text provides give some brief information about the parameters.

2. Mode S SSR DAPs ELS and EHS

2.1 Mode S DAPs-based surveillance includes ELS (Elementary Surveillance) and EHS (Enhanced Surveillance).

2.2 Most of the ELS parameters are capability parameters of the aircraft, hence are static. They can be used for improved aircraft identification, and have less direct impact on ATC operations. The ELS parameters are shown in Table 2.1.

Table 2.1 ELS Parameters Information

Register	DAP Set	Bits	Units	Quantity	Range
ELS	24-Bit Aircraft Address (AA)	NA	NA	NA	NA
	Transponder Capability (CA)	NA	NA	NA	NA
	Flight Status (FS)	NA	NA	NA	NA
	Altitude Reporting in 25ft	NA	ft	25	[-1000, 50175]
	BDS 1,0 Datalink Capability Report	56	NA	NA	NA
	BDS 1,7 Common GICB Capability Report	56	NA	NA	NA
	BDS 2,0 Aircraft Identification Report	56	NA	NA	NA
BDS 3,0 ACAS Resolution Advisory Report	9-22	NA	NA	NA	NA

2.3 EHS parameters are more related to the aircraft’s intention and status, and most of them are dynamic. The implementation of EHS parameters has a larger impact on controllers. The EHS parameters are shown in Table 2.2.

Table 2.2 EHS Parameters Information

Register	DAP Set	Bits	Units	Quantity	Range
EHS	BDS 4,0 Selected Altitude (MCP/FCU)	2-13	ft	16	[0, 65520]
	Selected Altitude (FMS)	15-26	ft	16	[0, 65520]
	Barometric Pressure Setting	28-39	mb	0.1	[0, 410]

*Mode S Downlink Aircraft Parameters
Implementation and Operations Guidance Document*

BDS 5,0	Roll Angle	3-11	dg	45/256	[-90, +90]
	True Track Angle	14-23	dg	90/512	[-180, +180]
	Ground Speed	25-34	kt	2	[0, 2046]
	Track Angle Rate	37-45	dg/s	8/256	[-16, +16]
	True Airspeed	47-56	kt	2	[0, 2046]
BDS 6,0	Magnetic Heading	3-12	dg	90/512	[-180, +180]
	Indicated Airspeed	14-23	kt	1	[0, 1023]
	Mach No	25-34	NA	2,048/512	[0, 4.092]
	Barometric Altitude Rate	37-45	ft/min	32	[-16384, +16352]
	Inertial Vertical Velocity	48-56	ft/min	32	[-16384, +16352]

3. Mode S SSR DAPs Data System

3.1 The ELS and EHS parameters originate from various sensors and cockpit settings. After being organized by the avionics systems, the information is being sent to the transponder through standard aircraft data buses, and subsequently formatted by the transponder and stored inside the relevant Binary Data Storages (BDS). The ground-based surveillance system could downlink desired DAPs by specific Mode S GICB (Ground Initiated Comm-B) protocol.

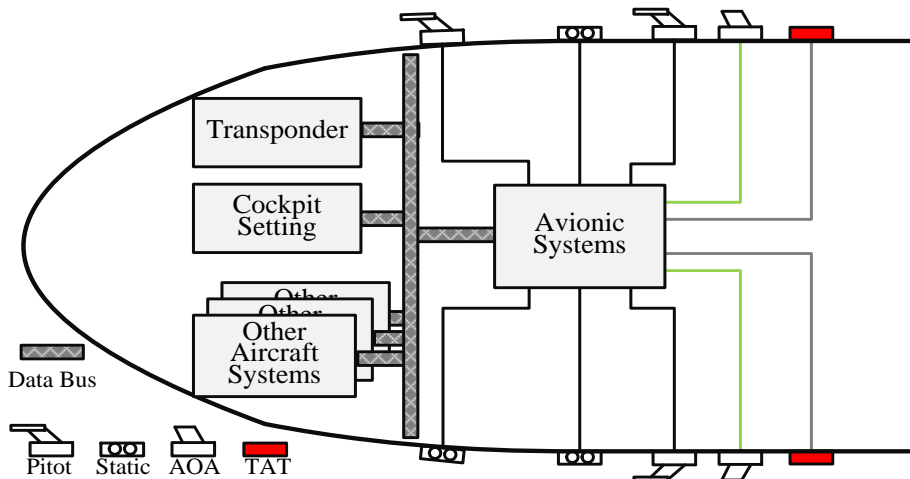

Figure 3.1 Typical DAPs Data Source Block Diagram

Transponder and TCAS Computer

3.2 The most common standard of the civil aircraft transponder, the Mark 4 Air Traffic Control Transponder, is based on the ARINC 718A standard. There are 3 main interface plugs defined on the rear panel, namely TP (Top Plug), MP (Middle Plug), and BP (Bottom Plug).

3.3 The airborne collision avoidance system, Traffic Computer TCAS and ADS-B Functionality, is based on the ARINC 735B standard. There are 6 main interface plugs defined on the rear panel, namely LTP (Left Top Plug), LMP (Left Middle Plug), LBP (Left Bottom Plug), RTP (Right Top Plug), RMP (Right Middle Plug) and RBP (Right Bottom Plug).

Mode S Downlink Aircraft Parameters
Implementation and Operations Guidance Document

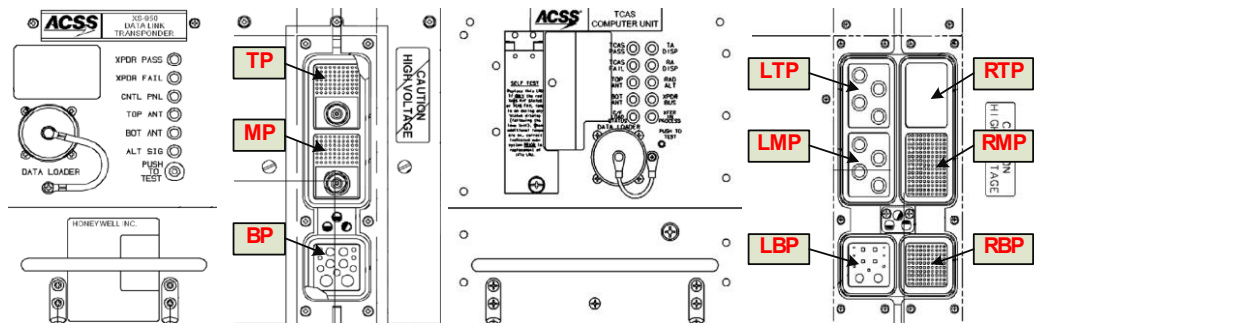

Figure 3.2 Transponder and TCAS Computer Examples from ACSS

Data Bus

3.4 The most common data bus, the Digital Information Transfer System, is based on the ARINC 429 standard. The standard defines the data transfer between most of the avionics systems. There are also other standards such as the ARINC 629 used on Boeing B777, Airbus A330 and A350, as well as the ARINC 664 (AFDX, Avionics Full Duplex Switched Ethernet) used on A380 and B787.

Avionics and DAPs Data

3.5 The Aircraft Address (AA) is a parameter programmed into the aircraft frame after the address is allocated by the State registration authority. Normally there are 2 ways to program this parameter, one is to program the pins of the MP (connected for “1”, open for “0”), and the other is to use Aircraft Personality Module (ARINC 607) to store the address, and then interface to the MP.

Note: For more detailed information about Aircraft Address, refer to ARINC 718A Attachment 2B. For APM implementation guidelines, refer to ARINC 718A Attachment 9.

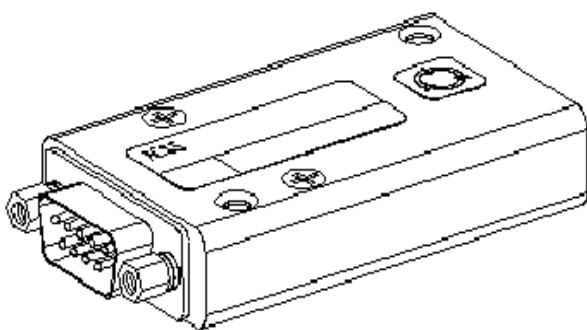

Figure 3.3 APM Example from ACSS

3.6 The Transponder Capability (CA) is a result of the combination of on-the-ground status and transponder capability level. Normally the on-the-ground status is automatically indicated by the weight sensor fitted on the aircraft, but some GA planes use manual means to indicate the status by switching the transponder knob to the GND option. The transponder receives on-the-ground status from the TP pins (5J and 5K), make validation of the status with Ground Speed, Radio Altitude or Airspeed, and then announce the status. The transponder capability level is a static value which is fixed after manufacturing.



Figure 3.4 TT31 Mode S Transponder from TRIG

3.7 The Flight Status (FS) is a result of combination of the on-the-ground status, SPI, and Alert. The on-the-ground is the same as in 3.6, the SPI is from pushing IDENT function button of the transponder by pilot, and the Alert is produced by changing Mode A code (If changed to 7500, 7600, 7700, that's permanent alert; and if changed to other codes, that's 18 seconds temporary alert).

3.8 The Common Usage GICB Capability Report is generated by the transponder itself by detecting the corresponding input data availability, and then set the corresponding bit related to that GICB register.

3.9 The main source of Aircraft Identification is from FMS, input by pilot through Flight ID (or Flight No) menu, and the related data transmitted to transponder by specific data bus (ARINC 429 Labels 233~237). If the Flight ID is empty, then the Aircraft Registration data may be provided within another data bus (ARINC 429 Labels 301-303).

3.10 According to TCAS standard (ARINC 735B Chapter 3.3.4.1), the Datalink Capability Report and the Resolution Advisories Report are sent to the Transponder from TCAS Computer by specific protocol (TGD-TCAS to Transponder data transfer protocol, and Transponder to TCAS data transfer protocol is named XGD. The data bus used is ARINC 429 Label 270). The data are sent from RMP of the TCAS Computer to TP of the Transponder, related pins refer to Figure 3.5.

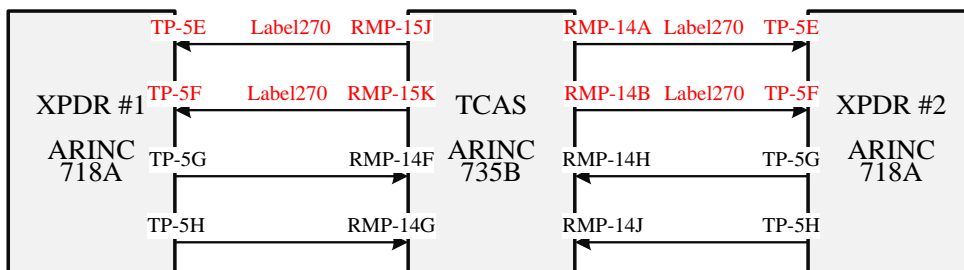

*Mode S Downlink Aircraft Parameters
Implementation and Operations Guidance Document*



Figure 3.6 MCP of Boeing B787 & FCU of Airbus A380

3.12 The Barometric Pressure Setting (BPS) is also located in the MCP/FCU, and set by the pilot rotating the knob to the pressure value comes from the aerodrome's ATIS (Automatic Terminal Information System).

3.13 The other parameters mainly come from the sensors onboard the aircraft, the sensors are organized in 3 groups, the air data sensors, the inertial sensors and the magnetic sensor.

3.14 The air data sensors are used to sense the medium through which the aircraft is flying, including pitot (static) probe, static port, temperature sensor, angle of attack sensor. Typical sensed parameters are total pressure (Pt), static pressure (Ps), pressure changing rate, air temperature (TAT), and angle of attack. Derived data includes Barometric Altitude (ALT), Indicated Airspeed (IAS), Vertical Speed (VS), Mach (M), Static Air Temperature (SAT), Total Air Temperature (TAT), True Airspeed (TAS) and Angle of Attack (AOA). The simplest system provides ALT and IAS.



Figure 3.7 Air Data Sensors and Integrated Sensor on Airbus A380

*Mode S Downlink Aircraft Parameters
Implementation and Operations Guidance Document*

3.15 The inertial sensors are used to detect the motion of the aircraft in a universal reference system, including position gyroscopes, rate gyroscopes and accelerometers. By detection of the 3D dynamic of the aircraft, derived data includes Ground Speed (GS), Wind Speed, Wind Direction, True Track Angle, Roll Angle, and Track Angle Rate and so on.

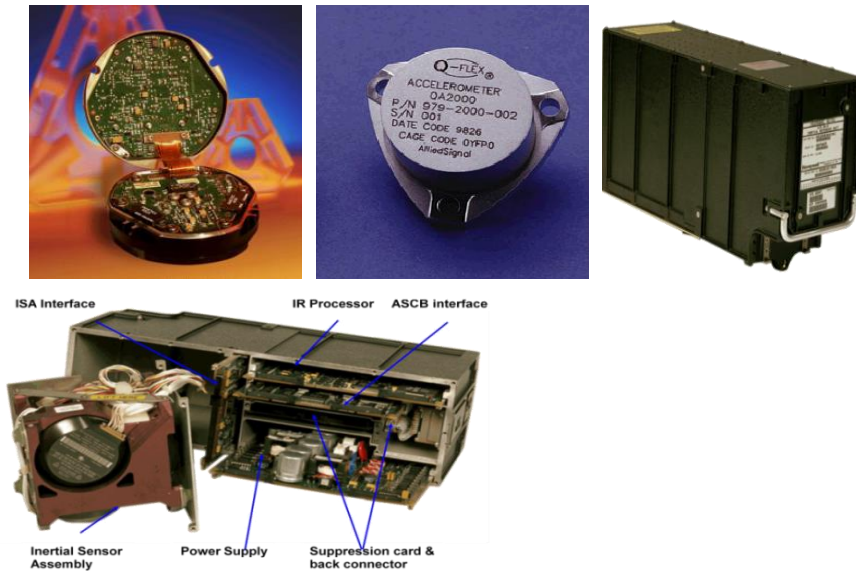

Figure 3.8 Gyro, Accelerometer and LASEREF IV IRU from Honeywell

3.16 The magnetic sensor is used to sense the direction and to find the magnetic north, and give out the main parameter of Magnetic Heading. The world magnetic model is show below:

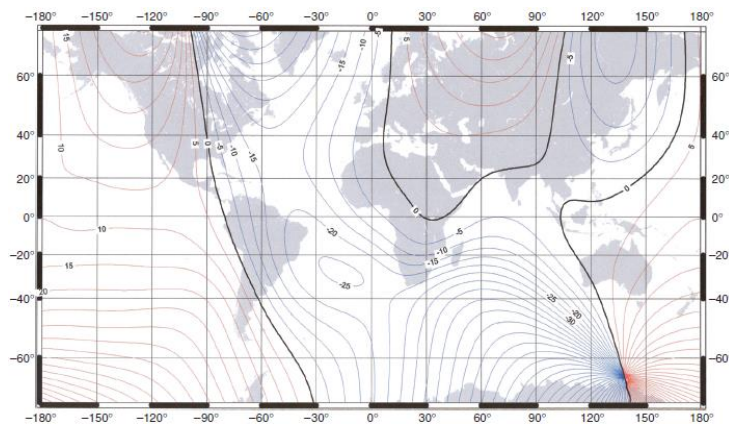

Figure 3.9 World Magnetic Model 2000

3.17 Some airplane platform uses an integrated solution to process these data, each air data sensor is connected with an Air Data Module (ADM) which converts the analog data to digital data and make the compensation of the instrumental and positional error. These data then feed to the input of Air Data Inertial Reference Systems (ADIRS) to calculate all the parameters mentioned before. And after that the parameters are sent to transponder and other avionics systems by the Data Bus.

Mode S Downlink Aircraft Parameters
Implementation and Operations Guidance Document

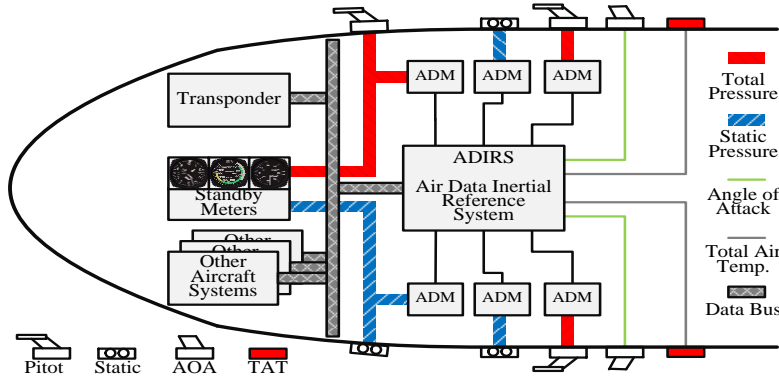

Figure 3.10 Typical ADIRS Architecture

3.18 The most commonly used data bus for parameters from ADIRS is ARINC 429 (and the newest evolution is AFDX invented by Airbus and implemented in various new aircrafts like A380 and B787), and the standard ARINC 429 Labels used by these parameters are as follows:

Table 3.1 ADIRS Parameters Used Labels of ARINC 429

No	DAP Item	Label
1	Mach No.	205
2	Indicated Air Speed	206
3	True Air Speed	210
4	Barometric Altitude Rate	212
5	Ground Speed	312
6	True Track Angle	313
7	Magnetic Heading	320
8	Roll Angle	325
9	Track Angle Rate	335*
10	Inertial Vertical Velocity	365

*Note: This label in GAMA configuration is not used for Track Angle Rate

3.19 By using these parameters, the aircraft dynamic is illustrated as in Figure 3.11.

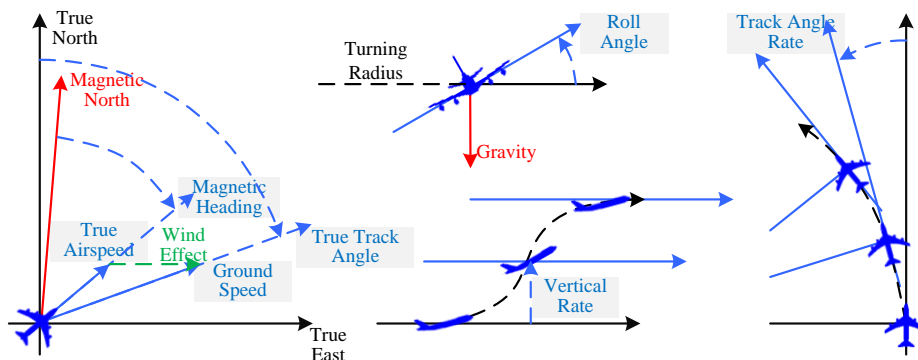
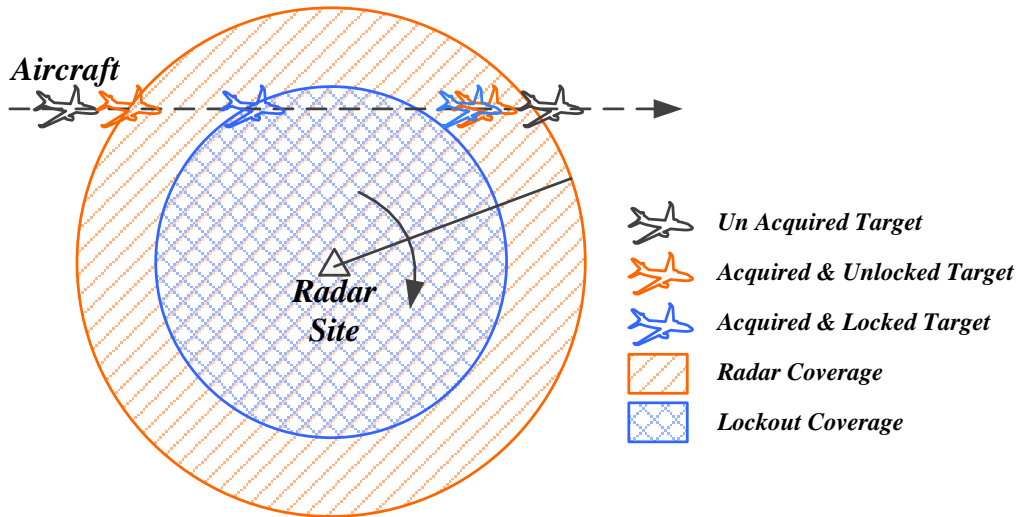

Figure 3.11 Illustration of Aircraft Dynamic

APPENDIX 4: Mode S Parameter Set

Radar Coverage R

1.1 The Mode S radar coverage is defined as the farthest target the radar will process. If the Mode S radar uses a lockout map, the difference of the two coverage ranges should be noticed.



1.2 The radar coverage will decide the minimal All-Call period, this is to say, the time of All-Call period should:

$$T \geq \frac{R * 2 * 1852}{3 * 10^8}$$

Antenna Period Ta

2.1 The antenna period is the time of a successful antenna rotation, this time actually has very important influence of the total time resource of the radar. Lower antenna rotation speed will provide rich antenna period, hence time resource of the radar. The most commonly used antenna period is 4000ms (15rpm) and 6000ms (10rpm) for terminal surveillance radar.

Antenna Beamwidth B

3.1 Most of the secondary surveillance radar uses the same LVA antenna, the beam is more or less the same, and the standard interrogation beam has a -3dB width of $2.45^\circ \pm 0.25^\circ$. In Mode S interrogation, the suppression requirement actually allow to use a wider beam width than -3dB width, most of the radar choose 3.8° or roughly the -10dB beam width.

Mode S Downlink Aircraft Parameters
Implementation and Operations Guidance Document

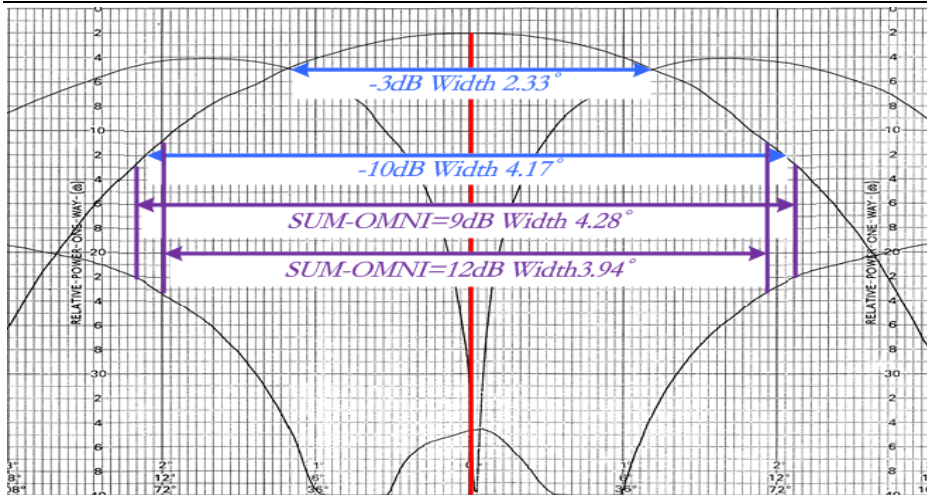

Time on Target T_t

4.1 The time on target is the total time amount the radar beam covers the target during one scan, it defines the time resource upper limit for one dedicated target, it is determined by both the antenna period and the beamwidth, and the relation is as follows:

$$T_t = \frac{T_a}{360} * B$$

4.2 It should be noticed that during a mix air operation (Conventional targets and Mode S targets flying in the same area in the same time), there is a need for the Necessary Transaction. That is during an antenna scan, there should be at least 4 transactions between the radar and the conventional target, in order not to miss conventional target.

All-Call Period T_{ac} and Roll-Call Period T_{rc}

5.1 The All-Call period and Roll-Call period setting are different radar by radar, but there should be some principles:

- 1) All-Call period should long enough to allow the coverage requirement.
- 2) During the time on target, the Necessary Transaction should be guaranteed.
- 3) Time resource should allocate to Roll-Call as much as possible; and
- 4) Algorithm should be used to optimize the scheduling in the Roll-Call period.

Mode Interlace Pattern MIP

6.1 Mode Interlace Pattern defines the radar operating mode setting. The setting is related to the specific radar environment, hence there is no standard MIP.

6.2 All the modes Mode S radar can use is listed in the following table:

*Mode S Downlink Aircraft Parameters
Implementation and Operations Guidance Document*



No.	Mode	Description	Pulse Used
1	A	Mode A interrogation	8μs between P1 and P3
2	C	Mode C interrogation	21μs between P1 and P3
3	A _S	Mode A Only All-Call	8μs between P1 and P3, and short P4
4	C _S	Mode C Only All-Call	21μs between P1 and P3, and short P4
5	S _L	Mode ACS All-Call	8μs, 21μs between P1 and P3, and Long P4
6	S _{PO}	Mode S Only All-Call P for PR, O for LO	2μs between P1 and P2, and P6 UF11 inside P6
7	R	Mode S Roll-Call	2μs between P1 and P2, and P6 UF0/4/5/16/20/21 inside P6

6.3 For a specific MIP, the describe phraseology defines as follows, and also one example is listed below:

Mode[Time]/ Mode[Time]/ Mode[Time]/.....

Note: The All-Call and Roll-Call periods are separated by “/”, the “Mode” is one of the Modes listed above, and the “[Time]” stands for the duration of the periods.

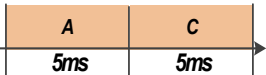
6.4 An example is show as follows:

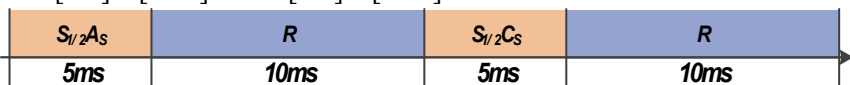
No.	Mode	MIP
1	Conventional	<p>A[5.0]/C[5.0]</p>  <p>Mode A and Mode C repeat, both durations are 5ms</p>
2	Mode S #1	<p>S_{1/2}A_S[5.0]/S_{1/2}C_S[5.0]/R[10.0]</p>  <p>2All-Call periods and 1 Roll-Call period repeat, All-Call duration is 5ms, Roll-Call duration is 10ms In the first All-Call, the PR=1/2, and use Mode A with short P4 In the second All-Call, the PR=1/2, and use Mode C with short P4</p>
3	Mode S #2	<p>S_{1/2}A_S[5.0]/R[10.0]/S_{1/2}C_S[5.0]/R[10.0]</p>  <p>1All-Call,1Roll-Call,1All-Call,1Roll-Call repeat, All-Call duration is 5ms, Roll-Call duration is 10ms In the first All-Call, the PR=1/2, and use Mode A with short P4 In the second All-Call, the PR=1/2, and use Mode C with short P4</p>

Interrogation Repetition Frequency IRF

*Mode S Downlink Aircraft Parameters
Implementation and Operations Guidance Document*

7.1 The Mode S introduced the Roll-Call period, which makes the interrogation repetition frequency a little bit different from the Conventional Mode. There is a need to define the interrogation repetition frequency by Mode IRF_{Mode}. Normally use IRF stands for the IRF_{AC} of Conventional mode and IRF_S of the Mode S All-Call. One example is listed below:

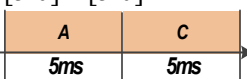
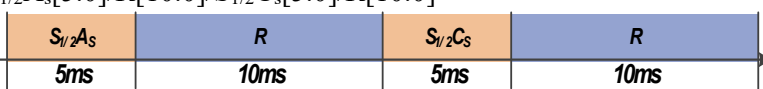
No.	MIP	IRF
1	A[5.0]/C[5.0] 	IRF _A =100Hz IRF _C =100Hz IRF _{AC} =200Hz
2	S _{1/2} A _s [5.0]/R[10.0]/S _{1/2} C _s [5.0]/R[10.0] 	IRF _A =33.3Hz IRF _C =33.3Hz IRF _{AC} =66.7Hz IRF _S =66.7Hz IRF _R =66.7Hz

DAPs Extraction Strategy

8.1 The DAPs extraction strategy normally includes the BDS number, extraction priority, extraction period, and re-extraction.

1) BDS number stands for the setting of the number of BDSs which radar is going to extract. It doesn't include the ELS registers, these registers should not be extracted periodically.

2) Extraction priority stands for the priority of each BDS when the radar is performing extraction, the priority should be in accordance to the user's needs;

3) Extraction period stands for the period of the dedicated BDS extraction, normally described by the antenna scan number.

4) Re-extraction stands for the function of re-extraction of the dedicated BDS in the same beam dwell when the extraction is failed, but it's not recommended to use re-extraction more than 2 times.

Mode S Parameter Set Example

9.1 The following is an example of the Mode S Parameter Set:

No.	Parameter	Unit	Value	Note
1	R Coverage Range	NM	200	Equivalent All-Call Time $\frac{200 * 2 * 1852}{3 * 10^8} * 10^3 \approx 2.47ms$
2	Ta Antenna Period	ms	3800	Antenna Rotation Period
3	B Work Beamwidth	°	3.8	Mode S Work Beamwidth Normally Greater Than -3dB width of 2.45°
4	Tt Time on Target	ms	40.1	The Time on Target In One Scan $\frac{3.8}{360} * 3800 \approx 40.1ms$

SURICG/7
Appendix A to WP/03

*Mode S Downlink Aircraft Parameters
Implementation and Operations Guidance Document*

5	Tac All-Call Period	ms	3.0	Equivalent Coverage Range $\frac{3 * 10^8 * 3.0 * 10^{-3}}{1852 * 2} \approx 243\text{NM}$
6	Trc Roll-Call Period	ms	7.0	This Period Related To The Extraction Efficiency
7	MIP	—	—	$S_{1/2}A_s[3.0]/R[7.0]/S_{1/2}C_s[3.0]/R[7.0]$
8	IRF _{AC}	Hz	100	Interrogation Repetition Frequency of Mode S All-Call
9	DAPs Extraction	—	—	No. of BDS: 3 (BDS 4,0 5,0 6,0) Extra. Priority: BDS 4,0 6,0 5,0 Extra. Period: 1 Scan Re-Extraction: Yes

APPENDIX 5: Radio Frequency (RF) Measurements and Analysis

The following is excerpted from ICAO Doc 9924 Aeronautical Surveillance Manual (Third Edition 2020), Appendix M: Interference Considerations.

1. Overview

1.1 The 1030 and 1090 MHz frequency bands form the worldwide RF network, which enables the cooperative surveillance of mobile vehicles involved in ATM including airborne vehicles (aircraft) and ground vehicles (e.g., specific vehicles operating on airport surface in critical areas). It is utilized to support civil and military (IFF) air-ground surveillance applications, air-air surveillance applications and collision avoidance applications.

1.2 In general, the 1030/1090 MHz network is robust in its ability to support the systems that utilize it but as more systems are added, performance of one or more of these systems may degrade to unacceptable levels. Since many systems are safety critical in nature, protecting the 1030/1090 MHz spectrum from reaching unacceptable utilization is paramount.

1.3 Capacity of the system is impacted by the number and types of users. Aircraft density and the number and type of interrogators directly influence the activity on these links. Information extraction from ground and aircraft to aircraft interrogators increases the activity of these RF links. High density airspace is a particular challenge as these locations tend to contain accompanying higher density of ground interrogators. The systems that utilize the 1030/1090 MHz bands have standards that limit their impact to protect the performance of all users and provide robust capacity to the system. However, available capacity can be limited in the highest density areas of the world.

1.4 Therefore, it is necessary to monitor the usage of the 1030/1090 RF network, as is required for any telecommunication network, in order to regulate its use. Such monitoring should support the determination of the remaining margin of the network. It should help identify the sources of the utilization and whether the limits are being reached by misuse of some systems operating in a non-conforming or inefficient manner to the detriment of the good operation of the other systems using the same network.

2. Radio frequency (RF) measurements

2.1 Measurements need to provide information to answer the following questions:

- a) what is the probability that a transponder correctly receives and decodes an interrogation sent on 1030 MHz (the utilization of the 1030 MHz frequency);
- b) what is the probability that a transponder is available to receive and decode interrogations and is able to reply (the availability of the transponder); and

- c) what is the probability that a 1090 MHz message is correctly received by a 1090 MHz receiver, which is impacted by overlaps of messages on 1090 MHz (the utilization of the 1090 MHz frequency).

2.2 Measurement methodologies

2.2.1 Data produced by RF measurement activities is recommended to include a minimum set of information that can adequately characterize the RF environment of the geographical area under assessment and support comparison to other measurements. Additionally, the data is intended to support comparison to other data collection measurements in other geographical areas which can provide insight to areas with high or unusual activity and help identify areas that warrant further investigation. To allow comparison between different measurements performed in different locations around the world, it is very important to define the types and the conditions of measurements. Measurements can be made from the ground and/or from the air. Each of them provides critical insight into the 1030/1090 MHz utilization.

2.2.2 Airborne measurements provide a larger area of measurement but are more difficult to conduct and result in higher cost. The airborne measurements provide both the ability to characterize ground sensor operations (1030 MHz) and transponder occupancy. Providing a 1030 MHz measurement enables the detection of all types of interrogations to which a transponder is receiving, i.e., interrogations to which a transponder does or does not transmit a reply. Therefore, it allows an estimation of transponder occupancy at the given points of measurement. It also allows the tracking of interrogations received but not generating replies (e.g., SLS interrogations, interrogations directed to other aircraft).

2.2.3 Ground measurements are more easily accomplished, less expensive but geographically limited. They allow the verification of transponder transmissions on 1090 MHz but are limited in their ability of providing a complete understanding of the environment that airborne aircraft are experiencing. Estimates of 1030 MHz activity can be somewhat estimated from measurement of 1090 MHz replies. However, there is no way to completely account for interrogations that do not result in a reply that impact transponder occupancy.

2.3 Metrics and measurement methods

2.3.1 Frequency occupancy

2.3.1.1 Method 1, In order to allow simple comparison of signal activity received on either 1030 MHz or 1090 MHz frequency, one method is to calculate a simple time occupancy that corresponds to the amount of time that there is a signal present above a given threshold without trying to extract or even decode the content of the messages. The process can be based on the following criteria:

- 1090 MHz frequency occupancy is defined by the proportion of time that there is a signal above the MTL (-84 dBm) for pulses greater than 0.3 microseconds in duration; and
- 1030 MHz frequency occupancy is defined by the proportion of time that there is a

*Mode S Downlink Aircraft Parameters
Implementation and Operations Guidance Document*

signal above the MTL (-74 dBm) for pulses greater than 0.3 microseconds in duration.

2.3.1.2 Method 2, which analyses the signal received on 1090 MHz, would be determined by decoding of, and counting the number of signals for, different types of messages. The 1090 MHz frequency band occupancy can also be estimated using a predefined occupancy time for each type of message. This message occupancy time is defined as the time there is a signal transmitted on the frequency, i.e., a pulse is transmitted. It signifies how long the transmission is occupying the frequency and therefore possibly interfering with another signal. The table below provides the values to be used to estimate the effective occupancy time and allow comparison between different measurements/estimations made by different authorities.

<i>Type of message</i>	<i>Time occupancy in μs</i>
Mode A/C reply	4.05 (9*0.45)
Short Mode S reply or squitter	30 (60*0.5)
Long Mode S reply or Extended Squitter	58 (116 *0.5)

2.3.1.3 Note that the occupancy of a Mode A/C reply depends on the number of pulses transmitted in each reply. For this calculation, an average value of 9 pulses (2 framing + 7 code pulses) has been used. This is sufficient to provide a first order estimation for comparison with the occupancy of other signal types.

2.3.1.4 The calculation of the number of replies of a given type multiplied by their corresponding time occupancy enables characterizing the impact of different message types on the frequency. Since this uses a fixed defined time occupancy for each type of message, the occupancy determined using this method, in general, will be lower than the occupancy computed using method 1 above, since it can be expected that interfering pulses that may occur during a detected message are not accounted for using method 2.

2.3.1.5 Method 3 is similar to the previous methods. An alternate occupancy calculation is based on the number of signals received on 1030 and 1090 MHz, which are decoded and from which signal rates are determined. However, the occupancy considers the entire signal length from the leading edge of the first pulse until the trailing edge of the last pulse as the time duration regardless of whether and how many intermediate pulses are transmitted. The rationale behind this method is that in RF high-density areas, multiple signal garbling is likely to occur and therefore pulse gaps are unpredictably filled. The determination of the band occupancy is based on the signal durations, as shown in table below.

<i>Type of message</i>	<i>1030 MHz signal duration</i>	<i>1090 MHz signal duration</i>
Mode 1	3.8 μ s	20.75 μ s
Mode 2	5.8 μ s	20.75 μ s
Mode 3/A	8.8 μ s	20.75 μ s

*Mode S Downlink Aircraft Parameters
Implementation and Operations Guidance Document*

Mode C	21.8 μ s	20.75 μ s
Mode C (Whisper/Shout)	23.8 μ s	20.75 μ s
Mode A only All Call	10.8 μ s	20.75 μ s
Mode C only All-Call	23.8 μ s	20.75 μ s
Mode A/Mode S All-Call	11.6 μ s	20.75 μ s or 64 μ s
Mode C/Mode S All-Call	24.6 μ s	20.75 μ s or 64 μ s
Mode C only All-Call (W/S)	25.8 μ s	20.75 μ s
Mode A only All-Call (W/S)	12.8 μ s	20.75 μ s
Short Mode S	19.75 μ s	64 μ s
Long Mode S	33.75 μ s	120 μ s

2.3.2 Determination of transponder reply and broadcast activity

2.3.2.1 By analyzing the transmissions made by a transponder, it is possible to verify if a transponder is transmitting above the minimum capabilities specified in Annex 10, Volume IV. The number of messages can be counted over 1 second and 100 msec sliding windows. The peak rates (i.e., the interval with the highest number of messages) detected over a given interval (e.g. 1 minute) can be compared to the values defined in Annex 10, Volume IV. Such information provides a good overall estimate of transponder activity caused by interrogators and makes possible the detection and further analysis of unexpected activity on the channel.

2.3.2.2 One method to estimate the number of messages transmitted by individual aircraft is by counting the number of messages received by a 1090 MHz receiver for aircraft in the vicinity of the receiver with a good link budget. However, achieving sufficient decoding performance is difficult but this method lends itself to a long-term ground-based monitoring system.

2.3.2.3 Another method is to conduct flight tests and detect and record the transmissions made by the operational transponder installed on the test aircraft. This is a good way to determine with high confidence the activity of an individual transponder in the environment. Decoding ownship replies is more accurate than attempting to analyse all the replies transmitted by all the other aircraft because the transmissions are received at high power, thereby reducing the problem of degarbling with other transmissions.

3. Additional data

3.1 Considering additional data such as aircraft environment and traffic density is desirable to assist in understanding the RF measurements that are obtained by the various methods previously identified. RF activity is a function of the number of systems operating, which includes the number and types of interrogators operating on the 1030 MHz frequency as well as the number and equipment of aircraft operating in the geographical area surrounding the measurement location.

*Mode S Downlink Aircraft Parameters
Implementation and Operations Guidance Document*

3.2 Data to describe the aircraft environment during a measurement activity is helpful to understand the relationship between the RF measurements and the aircraft traffic in the surrounding area. Traffic density and traffic patterns influence the RF activity in any given area or region. Determining the aircraft environment may require collecting and recording data from one or more ground SSRs. Data in time intervals of 10 to 15 minutes is suggested. To some extent, aircraft information can be determined by the RF measurement system itself. Mode S equipped aircraft can be detected by 1090 MHz reply via the 24-bit aircraft address and additionally the position of many aircraft can be determined by extended squitter data. ACAS equipage can be determined from 1030 MHz TCAS broadcast data, extended squitter as well as DF 0/16 reply content. These methods are limited to the receiver range of the measurement system but enable determining the nearby aircraft environment.

3.3 Information to describe the ground interrogator environment during a measurement activity is helpful to understand the relationship between the RF measurements and the number of interrogators in the surrounding area. Ground interrogators vary in characteristics that influence the impact to the RF environment. The expected RF contribution from ground interrogators can be predicted based on their characteristics such as PRF, scan rate, mode interlace pattern, beamwidth, power, etc. Although there is no way to associate measured 1030 MHz Mode A/C or Whisper-Shout interrogations to a given ground interrogator without detailed analysis of interrogation timing, particularly in the mainbeam, Mode S interrogator All-Call activity can be associated via the II/SI codes. There are many factors that influence overall RF activity with Mode S since ground interrogators may be extracting many GICB registers that increase the contribution of Mode S FRUIT caused by ground interrogators. It is possible to associate All-Call interrogations with UF 4, 5, 20 and 21 interrogations by examining mainbeam activity of detected Mode S ground interrogators.

3.4 Additional data that can be helpful in assessing the RF activity in a given region is the use of interrogation and reply data that is broadcast on extended squitter by so equipped aircraft. The capability to broadcast interrogation and reply data is incorporated into the future version of 1090 MHz extended squitter as a means of collecting useful 1030 and 1090 MHz activity data. The interrogation data is useful in conjunction with flight test measurements as it provides insight to the interrogation activity at different locations in addition to own aircraft. The reply data counts from the broadcasting aircraft enable comparison to the own aircraft rates as a function of time. For the purpose of ground monitoring of RF activity over time, decoding of the interrogation and reply monitoring extended squitter messages can be used for long term assessment of RF activity and enable capture of unusual or excessive RF activity events.

Terms of Reference of Mode S Radar and DAPs Working Group

Working Arrangement of the Mode S Radars and DAPS WG

Membership: The Mode S Radars and DAPS WG shall be composed of experts involved in technical and operation of surveillance services as well as operational experts. Member States of SURICG are encouraged to volunteer to form this Working Group. The working group shall normally invite representatives of International Organizations recognized by the ICAO Council and Industry Partners as required by the group which represent important civil aviation interests to participate in its work in a consultative capacity.

Meetings: The Mode S Radars and DAPS WG shall convene annually with at least one face-to-face meeting per year and supplemented with WebEx meetings as required. The outcome of the meetings shall be reported to the SURICG.

Schedule and delivery: Subject to the extent of prioritized applications considered by the Mode S Radars and DAPS WG, the schedule for delivery of the working group shall be 4 +2 years after initiation of the Mode S DAPS WG (28 March 2018). The delivery point(s) will be nominated by SURICG through discussion. The Mode S Radars and DAPS WG shall report to the APANPIRG via the SURICG.

Terms of Reference. See next section.

Term of Reference

The Objectives of Mode S Radars and DAPs Working Group are to:

- 1) Ensure harmonized implementation of Mode S radars and DAPs in the Asia and Pacific Regions according to Surveillance Strategy adopted by APANPIRG;
- 2) Facilitate the implementation of Mode S radars and DAPs application in the Asia and Pacific Regions using the project management principles where appropriate to maximize its benefit to region; and
- 3) Review, identify and address major issues in technical, operational and regulatory aspects to facilitate the Mode S radars and DAPs implementation in the Asia and Pacific Regions.

Deliverables to meet the Objectives:

- 1) Progress report to be submitted to SURICG addressing the Mode S Radars and DAPs Working Group deliverables (listed in 2 to 7 below);
- 2) To study and identify applicable Mode S radars and DAPs applications in the Asia and Pacific Regions considering:
 - Concept of use/operation;
 - Cost of system;
 - Requirement of surveillance systems (focusing on radar);
 - Matching functionality in ATC/ATM automation system;
 - Other currently available or emerging technologies;
 - ICAO Global Air Navigation Plan (GANP) and Aviation System Block Upgrades (ASBU); and
 - Evaluation method for Mode S radars and DAPs performance.

- 3) To identify and develop the regional requirements of Mode S radars and DAPs capability in the area of aircraft equipage, surveillance systems (focusing on radar) and ~~ATC-ATM~~ automation system, taking into account the relevant performance expectations of the Asia/Pacific Seamless ANS Plan;
- 4) To develop roadmap for Mode S radars and DAPs application in the Asia and Pacific Regions taking into account of:
 - Available equipment standards;
 - Readiness of airspace users and ATS providers; and
 - Development of standardized and systematic approach to Mode S radars and DAPs application.
- 5) To develop guidance materials to assist States and airspace users (where applicable) on the use of Mode S radars and DAPs in the Asia and Pacific Regions;
- 6) To encourage research and development, trials and demonstrations in the field of Mode S radars and DAPs application; and
- 7) Draft Conclusions and Decisions to be formulated relating to matters in the field of Mode S radars and DAPs that come within the scope of the SURICG work plan.

[Note: Mode S Radars and DAPS Working Group will report to SURICG and SURICG will coordinate with CNS Sub-group.]

Current Members: The working group is currently comprised of representatives from Australia, Cambodia, China, Hong Kong China, India, Indonesia, Japan, Republic of Korea, Malaysia, Nepal, New Zealand, Pakistan, Philippines, Singapore, Sri Lanka, Thailand and Viet Nam, and is led by China and Singapore.

Term of Reference

		Efforts thus far
The Objectives of Mode S Radars and DAPs Working Group are to:		
1	Ensure harmonized implementation of Mode S radars and DAPs in the Asia and Pacific Regions according to Surveillance Strategy adopted by APANPIRG;	a) Planning of II/SI code assignment in progress. b) Encouraged Mode S forward fit. c) Guidance material on the implementation of DAPs applications in ATM systems is created.
2	Facilitate the implementation of Mode S radars and DAPs application in the Asia and Pacific Regions using the project management principles where appropriate to maximize its benefit to region; and	High level principle is in the draft guidance material.
3	Review, identify and address major issues in technical, operational and regulatory aspects to facilitate the Mode S radars and DAPs implementation in the Asia and Pacific Regions.	a) Guidance material on measurement of frequency occupancy is created. b) Guidance material to address technical and operational issues is created. c) Guidance material to address regulatory issues is created.
Deliverables to meet the Objectives:		
1	Progress report to be submitted to SURICG addressing the Mode S Radars and DAPs Working Group deliverables (listed in 2 to 7 below);	
2	To study and identify applicable Mode S radar and DAPs applications in the Asia and Pacific Regions considering: - Concept of use/operation - Cost of system - Requirement of surveillance systems (focusing on radar) - Matching functionality in ATC automation system - Other currently available or emerging technologies; - ICAO Global Air Navigation Plan (GANP) and Aviation System Block Upgrades (ASBU); - Evaluation method for Mode S radars and DAPs performance.	a) Guidance material on the implementation of DAPs applications in ATM systems is created. b) Means to test and validate DAPs are in the guidance document.
3	To identify and develop the regional requirements of Mode S radars and DAPs capability in the area of aircraft equipage, surveillance systems (focusing on radar) and ATCATM automation system, taking into account the relevant performance expectations of the Asia/Pacific Seamless ATM Plan;	a) Planning of II/SI code assignment in progress. b) Encouraged Mode S forward fit. c) Guidance material on the implementation of DAPs applications in ATM systems is created.
4	To develop roadmap with a view to formulate mandates for Mode S radars and DAPs application in the Asia and Pacific Regions taking into account of: - Available equipment standards - Readiness of airspace users and ATS providers - Development of standardized and systematic approach to Mode S radars and DAPs application;	Road map created.

SURICG/7
Appendix B to WP/03

5	To develop guidance materials to educate States and airspace users (where applicable) on the use of Mode S radars and DAPs in the Asia and Pacific Regions:	Guidance material to educated States is created. No need for guidance material for airspace users identified yet.
6	To encourage research and development, trials and demonstrations in the field of Mode S radars and DAPs application; and	Research and development activities are being shared in the Working Group. These include: a) Deriving weather related information from DAPs; b) Detection of BDS swab.
7	Draft Conclusions and Decisions to be formulated relating to matters in the field of Mode S radars and DAPS that come within the scope of the SURICG work plan.	On going.

SURICG/7
Appendix C to WP/03

LIST OF ACTION ITEMS

No.	Subject	Forum Raised	Status / Target Date	Remarks / follow-up	Action Party
1.	II code coordination for ADS-B and MLAT	DAPs WG/2	On-going	New guidance material is under development by SP, DAPS WG will monitor the progress	China, Malaysia and Singapore
2.	Update DAPs Implementation Status table for APAC region	DAPs WG/2	On-going basis	To update the information in the table as necessary.	Member States
3.	Harmonization with air space users	SURICG/2	On-going basis	Invite avionics manufacturers and airlines to share experience, where possible.	Co-chairs and hosting States
4.	Align with APAC Seamless ANS Plan 3.0, GANP 2019 and A40, ANC/13 outcome	DAPs WG/3	DAPs WG/6	As the IGD2.0 and roadmap have been developed, it's necessary to further align the direction and timeline of regional implementation with global guideline by updating the action list, IGD and roadmap.	Co-chairs, ICAO
5.	Propose to Surveillance Panel on the addition of SI code allocation criteria in a mixed II and SI mode into Doc 9924	DAPs WG/4	DAPs WG/5 (Completed)	It was noted that Doc 9924 does not provide guidance for the allocation of IC in a mixed II and SI mode.	Co-chairs, ICAO, Robert Witzen
6.	Create an ad-hoc group to study the migration from II code to SI code schemes and strategies for APAC	DAPs WG/4	DAPs WG/6	Recognizing the challenges for APAC in migrating to mixed II and SI operation	Co-chairs, ICAO, States, Robert Witzen
7.	Study allocation of II code 14 and 15 for specific purposes in APAC	DAPs WG/4	DAPs WG/5 (Completed)	As II code 14 and 15 have been implemented in States. Undertaken by the same ad-hoc group created for Action Item 6.	Co-chairs, ICAO, States, Robert Witzen
8.	Conduct a survey with APAC states to request the information about the current use of EHS mode	DAPs WG/4	DAPs WG/5 (Completed)	Understanding the challenges and difficulties faced by states in implementing APANPIRG conclusion C 31/14	ICAO

LIST OF ACTION ITEMS

No.	Subject	Forum Raised	Status / Target Date	Remarks / follow-up	Action Party
9.	Take necessary action to update the accurate SAC allocation in APAC to EUROCONTROL website.	DAPs WG/4	DAPs WG/5 (Completed)	To update EUROCONTROL with the latest SAC allocation within Asia Pacific, and correct the SAC assignment of Afghanistan as it is now in APAC region	Co-chairs, ICAO
10.	Reservation of II codes 14 and 15 for Research, Test and Military Purposes	DAPs WG/5	On-going	To decide when significant number of radars migrated from II to Surveillance Identifier (SI) codes. ICAO APAC will make a conscious effort to avoid allocating II 14 and 15 (and the matching SI codes) to new radars unless due to capacity issue.	Co-chairs, ICAO

MODE S DAPs IMPLEMENTATION STATUS IN THE APAC REGION

No.	State/ Administration	Mode-S Surveillance Facilities and ATM System Readiness	Operational Status	Remark
1	CHINA	<p>78 Mode-S capable radars.</p> <p>Now ATM automation systems could process the DAPs including the position altitude and Mode 3/A Code.</p> <p>By 31 December 2021, ATM system ready to process almost all the DAPs.</p>	<p>Radars and DAPs application in ATM system for the first stage are operational</p>	
2	INDIA	<p>30 Mode-S capable Radars have already been installed.</p> <p>All ATM systems except Chennai are capable to process DAPs.</p>	<p>Out of 30 Mode-S capable Radars, 28 radars are presently operational.</p> <p>All DAPs capable ATM systems are operational.</p>	<p>Commissioning of remaining 02 Mode-S capable radars is under process.</p>
3	INDONESIA	<p>26 Mode-S capable Radars</p> <p>ATM system in some locations are capable to DAPs; and ATM systems in some other locations are in evaluation for DAPs.</p>	<p>Radars are in operational.</p> <p>ATM systems in some locations are in operational; and the rest are in evaluation process.</p>	
4	JAPAN	<p>4 Mode-S capable radars</p> <p>ATM system is in evaluation process for DAPs.</p>	<p>Radars are operational and DAPs application in ATM is in evaluation.</p>	

SURICG/7
Appendix D to WP/03

No.	State/ Administration	Mode-S Surveillance Facilities and ATM System Readiness	Operational Status	Remark
5	MALAYSIA	<p><u>Surveillance Facilities:</u></p> <p>Kuala Lumpur FIR</p> <p>Mode-S Radar 5 Mode-S capable SSR are operational</p> <p>ADS-B 3 ADS-B ground stations are operational</p> <p>In Progress 2 Mode-S capable SSR being Installed (will be operational in 2024)</p> <p>Kota Kinabalu FIR</p> <p>Mode-S Radar 5 Mode-S capable SSR are operational</p> <p>ADS-B 4 ADS-B ground stations are operational</p> <p>In Progress 1 Mode-S capable SSR being Installed (will be operational in 2024)</p> <p>ATM System Readiness: The ATM system in Kuala Lumpur and Kota Kinabalu FIR are capable to process DAPs</p>	Radars and DAPs application in ATM system are operational	<p><u>Note:</u> As of March 2019, CAA Malaysia is embarking Optimization Programme of CNS/ATM as part of CAA Malaysia Transformation.</p> <p>Under this programme, CAA Malaysia is to achieve 100% of Mode-S Coverage by year 2021 in Peninsular Malaysia, Sabah & Sarawak.</p> <p>*Currently, DAPs information is evaluated for safety case studies and data analytic.</p> <p>CAA Malaysia is in supports of the DAPs implementation in APAC Region. In view of this, the earliest for full implementation of DAPs in Malaysia will be in 2025 to make way for infrastructures, procedures and technical competency readiness; coordination and bilateral agreement with all stakeholders that will be affected and benefited from this implementation are in agreement.</p>

SURICG/7
Appendix D to WP/03

No.	State/ Administration	Mode-S Surveillance Facilities and ATM System Readiness	Operational Status	Remark
6	NEW ZEALAND	Current Operational Surveillance equipment: 5 MSSR, 1 combined MSSR/PSR and 2 PSR 1 MLAT for surface movements, 1 MLAT for WAM 27 ADSB sites (some dual, others single).	All current surveillance systems are operational. The ATM is processing all DAPS data from ADSB, MLAT and MSSR – MODE A/C/S Code, Flight ID, SFL, IAS, and MACH data is provided to controllers, other data is used by the ATM – e.g., for calculating the wind speed/direction.	Planned Install 3 New MSSR/PSR. Remove Old MSSR/PSR - 5 MSSR, 1 combined MSSR/PSR and 2 PSR Note, New Zealand does not have a MODE S Mandate.
7	PHILIPPINES	12 Mode-S capable radars ATM system Capable of DAPs.	All radar systems are Operational ATM systems are likewise operational with DAPs capability disabled	Temporarily turned off/disabled due to some issues as advised by the vendor (Thales).
8	SINGAPORE	3 Mode-S capable radars ATM system ready to process DAPs.	Radars and DAPs application in ATM system are operational	
9	SRI LANKA	2 Mode-S Radars Being Implemented ATM system for Approach Control Centre at BIA with DAPs Processing, Being Implemented ATM system for Area Control Centre with DAPs Processing, planned implementation	Targeted to be available by 2022 Targeted to be available by 2022 Targeted to be available by 2023	WAM System with the DAPs capability to be implemented in parallel to the implementation of DAPs Compatibility in ATM systems by 2022
10	THAILAND	12 Mode-S EHS RADARs The new ATM system, TMCS project, is capable to process DAPs. The TMCS made use of DAPs as information for ATC for determining.	The TMCS project has been fully operating since last quarter of year 2020.	

SURICG/7
Appendix D to WP/03

No.	State/ Administration	Mode-S Surveillance Facilities and ATM System Readiness	Operational Status	Remark
11	VIET NAM	- 2 Mode-S capable radars - 2 ATM system ready to process DAPs. - 13 ADS-B stations	- Radars and ATM are capable of handling Mode S DAPs but not yet officially operation. - ADS-B is on operation	Vietnam is deploying following projects in 2019 -2021: - New 5 SSR Mode Station (EHS), - 10 ADS-B stations; - 01 MLAT system, - New Ho Chi Minh ATCC and new Da Nang ATCC (with new modern ATM system).
