



ICAO

International Civil Aviation Organization

**THE FOURTH MEETING OF MODE S DOWNLINKED
AIRCRAFT PARAMETERS WORKING GROUP
(MODE S DAPs WG/4)**

Video Teleconference, 29 – 31 March 2021

Agenda Item 7: Review Guidance Material of implementation of Mode S DAPs

**UPDATES TO THE MODE S DAPs IMPLEMENTATION AND OPERATIONS
GUIDANCE DOCUMENT**

(Presented by China and Singapore)

SUMMARY

The revised draft (Edition 3.0) of the Mode S DAPs Implementation and Operations Guidance Document was developed based on the adopted edition 2.0. And it is prepared for consideration and endorsement by this meeting.

1. INTRODUCTION

1.1 Follow the conclusion CNS SG/24/14, the edition 2.0 of the Mode S DAPs IGD has been adopted to provide guidance material for the implementation and operational application of the Mode S DAPs in the Asia and Pacific Regions.

1.2 The revised draft (Edition 3.0) of the Mode S DAPs IGD was completed recently. The revised draft was circulated to members of the Working Group for comments on 15 March 2021. China received comments on Mode S transponder mandate and the use of ACAS RA from New Zealand. Follow these comments, China revised the document and present it to be endorsed.

1.3 The main amendments to this edition include:

- compile the preface of the guidance document, add the benefit of using the Mode S conspicuity code (A1000) in section 1.2.2,
- introduce the ASTERIX formats and update the link of the website where can download the specification documents in section 4.3,
- supply descriptions of fields in Mode S DAPs problem report form in section 6.4.2,
- propose advice to mandating Mode S transponder in section 7.2,
- supply descriptions of other protocols for DAPs extraction in section 7.3,
- revise the descriptions of the use of parameters in the ATM automation system in section 7.4,
- add two examples of Mode S DAPs application in section 9 ,
- and three identified issues in appendix 1,
- add information of Mode S radar parameter set in appendix 4.

Agenda Item 7

29-31/03/21

2. DISCUSSION

Compile the preface of the guidance document

2.1 In the preface, introduce the objective of developing the Mode S IGD, explain the progress of this guidance document development, and acknowledge the support from ICAO APAC Office and contributions from the volunteer State/Administration. Accordingly, delete the list of participants.

Propose advice to mandating Mode S transponder

2.2 As the conclusion APANPIRG/31/14 regarding the fitment of Mode S equipage was adopted, States/Administrations should according to the conclusion when publishing mandate or regulations.

Supply descriptions of other protocols for DAPs extraction

2.3 As only introduce the DAPs extraction by GICB (Ground-Initiated Comm-B) protocol in the IGD before, supply the DAPs extraction by AICB (Air-Initiated Comm-B) protocol and Comm-B broadcast which are used by register 10_{16} , 20_{16} and 30_{16} when its contents change.

Revise the descriptions of the use of parameters in the ATM automation system

2.4 Propose advice of the use of ACAS RA, describe the MTCDD (Medium Term Conflict Detection) and MSAW (Minimum Safe Altitude Warning) as two examples of improving the accuracy of safety nets through the selected altitude, and supply the use of Barometric Pressure Setting which replace the Barometric data. And revise related expressions in sections 4. 2 and 9.2 accordingly.

Add two examples of Mode S DAPs application and three identified issues

2.5 Add the use of Mode S DAPs data for weather forecast according to the IP11 was presented by Japan during the Mode S DAPs/3 and the use of barometric pressure setting based on experience in section 9. Add the empty ACAS RA message according to the IP10 was presented by Korea during the Mode S DAPs/3, erroneous SFL information and incorrect ACAS RA information base on experience in appendix 1.

Add information of Mode S radar parameter set

2.6 China presented IP/06 about Mode S radar parameter set during the Mode S DAPs/3, and add the related information in appendix 4.

2.7 For detailed information please refer to **Appendix A**, which is the Mode S DAPs IGD edition 3.0 modified base on the edition 2.0.

3. ACTION BY THE MEETING

3.1 The meeting is invited to

- a) Review and comment on the proposed changes.
- b) Discuss any relevant matters as appropriate.

**DAPs WG/4
Appendix A to WP/12**



**INTERNATIONAL CIVIL AVIATION ORGANIZATION
ASIA AND PACIFIC OFFICE**

**MODE S DOWNLINK AIRCRAFT PARAMETERS IMPLEMENTATION
AND OPERATIONS GUIDANCE DOCUMENT**

Edition 23.0 – ~~May~~ **March 2020-2021**

|

Intentionally left blank

PREFACE

This publication is one of the deliverables of the Mode S DAPs WG according to the Terms of Reference (TOR). It aims at providing guidance materials to States and airspace users on the use of Mode S DAPs in the Asia and Pacific Regions from both operational and technical perspectives. A working team was established to develop the contents, and China has volunteered to take lead on coordinating and consolidating inputs from members of the working team.

During Mode S DAPs WG/1 held in March 2018, the meeting considered that further development work is required before the initial draft (Edition 0.1) proposed by China and Hong Kong China becomes ready for approval. Then the working team began to develop the contents of the guidance document, China organized two internal conferences and ICAO APAC office organized a web conference for reviewing the contents. Based on numerous rounds of review and comments with joint efforts from the working team, China has revised the draft into five previous versions. Finally, Edition 1.0 was submitted for endorsement after Mode S DAPs WG/2, and published in the CNS SG/23. China revised the document and circulated it to the members of the Working Group for comments. Then Edition 2.0 was released in 2020, during CNS SG/24. The revised draft (Edition 3.0) is prepared and proposed to be endorsed by Mode S DAPs WG/4.

The support from ICAO APAC Office and contributions from the following volunteer State/Administration and industry partner in preparing the guidance material is acknowledged and highly appreciated:

- Air Traffic Management Bureau of CAAC, China
- The Second Research Institute of CAAC, China
- Civil Aviation Authority of Singapore
- Hong Kong Civil Aviation Department, China
- Japan Civil Aviation Bureau
- Electronic Navigation Research Institute, Japan
- Airways, New Zealand
- Airservices, Australia

TABLE OF CONTENTS

1. INTRODUCTION.....	7
1.1 PURPOSE	7
1.2 BACKGROUND	7
1.2.1 Mode S and DAPs.....	7
1.2.2 Benefit of Mode S and Use of DAPs	8
1.3 ARRANGEMENT OF DAPS IGD	8
1.4 DOCUMENT HISTORY AND MANAGEMENT	8
1.5 COPIES.....	9
1.6 CHANGES TO DAPS IGD.....	9
1.7 EDITING CONVENTIONS	9
1.8 DAPS IGD REQUEST FOR CHANGE FORM.....	10
1.9 AMENDMENT RECORD	11
2. ACRONYMS LIST	12
3. REFERENCE DOCUMENTS	14
4. DESCRIPTION OF MODE S DAPS DATA	16
4.1 MODE S ELS	16
4.2 MODE S EHS	17
4.3 DAPS DATA EXCHANGE PROTOCOL BETWEEN SURVEILLANCE AND ATM AUTOMATION SYSTEM	18
5. IMPLEMENTATION PRINCIPLES AND PHASES	20
5.1 IMPLEMENTATION PRINCIPLES.....	20
5.1.1 Stakeholders Coordination	20
5.1.2 System Compatibility	20
5.1.3 DAPs Data Integrity	21
5.1.4 System Integration	21
5.2 IMPLEMENTATION CHECKLIST	22
5.2.1 Activity Sequence.....	22
5.2.2 Concept Phase	22
5.2.3 Design Phase	23
5.2.4 Implementation Phase	24
6. SYSTEM INTEGRITY AND MONITORING	25
6.1 INTRODUCTION.....	25
6.2 PERSONNEL LICENSING AND TRAINING.....	25
6.3 ATS SYSTEM VALIDATION	25
6.3.1 Safety Assessment Guidelines	25
6.3.2 System Safety Assessment	25
6.3.3 Integration Test.....	26
6.3.4 ATS Operation Manuals	26
6.4 SYSTEM MONITORING	26
6.4.1 Consideration for System Monitoring.....	26

6.4.2	Mode S DAPs Problem Reports	27
6.4.3	Example of Mode S DAPs Problem	28
6.5	APPLICATION ANALYSIS	28
6.5.1	Data Recording.....	29
6.5.2	Local Data Collection.....	29
6.5.3	Avionics Problem Identification and Correction.....	29
6.6	IDENTIFIED ISSUES	29
7.	REGULATIONS AND PROCEDURES	30
7.1	MANDATING MODE S DAPs	30
7.2	AVIONICS	31
7.2.1	Mode S Transponder Capabilities	31
7.2.2	Mode S Transponder Mandate.....	32
7.2.3	Transition Guidelines.....	33
7.2.4	Interrogation of Transponders on Ground Mode S Transponder Working on the Ground	33
7.3	MODE S INTERROGATOR	34
7.3.1	Working Principles	34
7.3.2	Interrogator Codes	34
7.3.3	Interrogation Methods Mode Interlace Pattern.....	34
7.3.4	Interrogate Comm-B Data DAPs Extraction by GICB Protocol	35
7.3.5	DAPs Extraction by AICB Protocol.....	37
7.3.6	DAPs Extraction by Comm-B Broadcast.....	37
7.4	ATM AUTOMATION SYSTEM	37
7.4.1	Elementary Surveillance	37
7.4.2	Enhanced Surveillance	38
7.5	FLIGHT PLANNING	40
7.5.1	ICAO Flight Plan Item 7 - Aircraft Identification.....	40
7.5.2	Equipment (Surveillance Equipment /SSR Equipment).....	40
7.5.3	Inconsistency between Mode S Flight Planning and Surveillance Capability.....	41
7.5.4	Setting Flight ID in Cockpits	42
7.6	CONTINGENCY PLAN	42
8.	TRAINING AND COMPETENCE	43
8.1	INTRODUCTION	43
8.2	TRAINING OF AN AIR TRAFFIC CONTROLLER (ATC) IN DAPs	43
8.3	TRAINING OF AN ATSEP IN DAPs	43
8.4	COMPETENCY ASSESSMENT OF AN ATSEP IN DAPs	44
9.	SPECIFIC EXAMPLES ON MODE S DAPs APPLICATION	45
9.1	USE OF SELECTED ALTITUDE	45
9.2	USE OF ACAS RA	45
9.3	USE OF MODE-S DAPs DATA FOR WEATHER FORECAST	46
9.4	USE OF BAROMETRIC PRESSURE SETTING	46
APPENDIX 1:	MODE S DAPs ANALYSIS	49

APPENDIX 2: LIST OF IDENTIFIED ISSUES.....53
APPENDIX 43: A BRIEF INTRODUCTION OF MODE S DAPS DATA SOURCE.....61
APPENDIX 4: MODE S PARAMETER SET.....69

1. INTRODUCTION

1.1 Purpose

This Mode S Downlink Aircraft Parameters Implementation and Operations Guidance Document (DAPs IGD) provides guidance for the planning, implementation and operational application of Mode S DAPs technology in the Asia and Pacific Regions.

The procedures and requirements for Mode S DAPs operations are detailed in the relevant States' AIP. This IGD is intended to provide key information on Mode S DAPs performance, integration, principles, procedures and collaboration mechanisms.

The content is based upon the work to date of the Mode S DAPs Working Group and various ANC Panels for the operational use of Mode S DAPs.

1.2 Background

1.2.1 Mode S and DAPs

Mode S (Select) is an extension of conventional SSR which permits selective addressing of individual aircraft equipped with Mode S transponders. Additional data known as Downlink Aircraft Parameters (DAPs) may also be extracted from the aircraft, including aircraft identification which should correspond to the ACID entered in the flight plan.

Mode S operates on the same radio frequencies (1030 and 1090 MHz) as conventional SSR systems, allowing for interrogation of ~~older~~ Mode A/C **only** transponders and ~~well as more modern~~ Mode S transponders.

Each Mode S equipped aircraft is assigned a unique ICAO 24-bit aircraft address. Using the selective interrogation capability of the Mode S SSR, Mode S Sensors are able to first acquire and then selectively interrogate a specific aircraft via its unique ICAO 24-bit aircraft address. This significantly improves the radar's detection and tracking performance, and therefore improving the ability of ATC to monitor and control the aircraft, as well as the others around it.

The innovation of Mode S resides in the use of selective addressing of aircraft which offers technical advantages over conventional SSR, such as reducing "fruit" and "garbling", providing higher integrity radar tracks.

Mode S technology has the following characteristics:

- a) selective interrogation,
- b) individual aircraft address and
- c) datalink capability.

The Mode S application includes Mode S radar system, datalink Systems, MLAT Systems, etc.

Various avionics systems onboard an aircraft receive data from sensors to provide the DAPs output. The data mainly comes from several sets of sensors, such as air data sensors (including pitot probe, static port, temperature sensor, **and** angle of attack sensor), inertial sensors (including position gyroscopes, rate gyroscopes and accelerometers) and magnetic sensor(s). Part of the parameters produced by other avionics systems (such as MCP/FCU, FMS, TCAS, etc.) ~~are~~ **is** also defined as downlink aircraft

parameters. These parameters are then sent to the transponder through standard data buses, and stored inside the relevant transponder's 56-bit Binary Data Storages (BDS). Ground-based surveillance systems (such as MSSR or MLAT) can downlink the desired parameters using specific Mode S protocols.

For detailed information about DAPs data source, please refer to Appendix 43.

Mode S DAPs is an application of the Mode S Datalink System. The downlink standard length transaction interface shall deliver DAPs to the transponder which then makes data available to the ground surveillance systems. Each DAP shall be packed into the Comm-B format ('MB' field) and can be extracted using either the ground-initiated Comm-B (GICB) protocol, or using MSP downlink channel 3 via the ~~dataflash~~ **data flash** application.

1.2.2 Benefit of Mode S and Use of DAPs

The Mode S application reduces the weakness of Mode A/C, because of the selective interrogation reducing synchronous garble and asynchronous interference. The parity check technique improves the reliability and integrity of surveillance data. The availability of almost 17 million unique aircraft addresses, in conjunction with the automatic reporting of flight identity, alleviates Mode 3/A code shortages and enables unambiguous aircraft identification, if the correct aircraft address and/or Aircraft Identification are entered in both the flight plan and aircraft systems. The datalink technique assists the acquisition of downlink aircraft parameters, and the additional track label information improves the air situational awareness. The controller and pilot are presented with improved situation awareness, which reduces the R/T workload.

Another benefit is to maximize SSR Mode 3/A code savings. By introducing the Mode S Conspicuity Code, all aircraft identified by Mode S via DAPs (ACID) can use the same SSR Mode 3/A code. During the 6th meeting of ATM SG, the following Conclusion is adopted:

Conclusion ATM/SG/6-3: Proposed Air Navigation Plan Volume II Amendment

'A1000' was reserved for the Mode S Conspicuity Code for the ICAO APAC region.

1.3 Arrangement of DAPs IGD

The Mode S DAPs Implementation and Operations Guidance Document consists of the following parts:

Section 1	Introduction
Section 2	Acronym Lists
Section 3	Reference Documents
Section 4	Description of Mode S DAPs Data
Section 5	Implementation Principles and Phase
Section 6	System Integrity and Monitoring
Section 7	Regulations and Procedures
Section 8	Training and Competence
Section 9	Specific Examples on Mode S DAPs Applications

1.4 Document History and Management

The framework of this document was introduced in the first Working Group Meeting of Mode S Downlink Aircraft Parameters in March 2018. The Meeting agreed to further develop based on the proposed framework to a complete document for approval as a regional guidance document. A working team, consisting of volunteers from China, Hong Kong-China, Japan, Malaysia, Singapore, Thailand and

New Zealand was established by the Meeting to contribute to the content of the document. In July 2018, the completed draft of this document was ready for circulation among States for review and comment.

The aim of this document to supplement SARPs, PANS and relevant provisions contained in ICAO documentation and it will be regularly updated to reflect evolving provisions.

1.5 Copies

Paper copies of this DAPs IGD are not distributed. Controlled and endorsed copies can be found at the following ~~web site~~ **website**: <http://www.icao.int/APAC/Pages/edocs.aspx> and may be freely downloaded from the ~~web site~~ **website**, or by emailing APANPIRG through the ICAO Asia and Pacific Regional Office who will send a copy by return email.

1.6 Changes to DAPs IGD

Whenever a user identifies a need for a change to this document, a Request for Change (RFC) Form (see Section 1.8 below) should be completed and submitted to the ICAO Asia and Pacific Regional Office. The Regional Office will collate RFCs for consideration by the Surveillance Implementation Coordination Group.

When an amendment has been ~~agreed~~ **adopted** by ~~a~~ **the** meeting of the Surveillance Implementation Coordination Group, then a new version of the DAPs IGD will be prepared, with the changes marked by an “|” in the margin, and an endnote indicating the relevant RFC, so a reader can see the origin of the change. If the change is in a table cell, the outside edges of the table will be highlighted; e.g.:

--	--	--

Final approval for publication of an amendment to the DAPs IGD will be the responsibility of APANPIRG.

1.7 Editing Conventions

(Intentionally blank)

1.8 DAPs IGD Request for Change Form

RFC Nr:	
----------------	--

Please use this form when requesting a change to any part of this DAPs IGD. This form may be photocopied as required, emailed, faxed or e-mailed to ICAO Asia and Pacific Regional Office +66 (2) 537-8199 or APAC@icao.int

1. SUBJECT:			
2. REASON FOR CHANGE:			
3. DESCRIPTION OF PROPOSAL: [expand / attach additional pages if necessary]			
4. REFERENCE(S):			
5. PERSON INITIATING:		DATE:	
ORGANISATION:			
TEL/FAX/E-MAIL:			
6. CONSULTATION RESPONSE DUE BY DATE:			
	Organization	Name	Agree/Disagree
			Date
7. ACTION REQUIRED :		DATE REC'D :	
8. DAPs IGD EDITOR		DATE :	
9. FEEDBACK PASSED			

1.9 Amendment Record

Amendment Number	Date	Amended by	Comments
0.1	20 March 2018	China Hong Kong, China	Initial draft for consideration by Mode S DAPs WG/1
0.2	1 August 2018	China Hong Kong, China Japan Singapore Malaysia	First completed draft based on the agreed document framework in Mode S DAPs WG/1 for review and comment by States
0.3	23 August 2018	China	Based on Version 0.2 draft, China hold a meeting to discuss problems respecting the first completed draft. This is a revised document according to content of this meeting.
0.3.1	26 September 2018	China Hong Kong, China Singapore New Zealand	Based on Version 0.3 draft, States make a full comment on the content of IGD. This is a revised document according to those comments.
0.3.2	6 November 2018	China New Zealand Hong Kong, China Singapore Malaysia	Based on Version 0.3.1 draft, States discussed all comments of IGD in the Mode S DAPs WG 1st Web Conference. This is revised by the meeting decisions.
0.4	27 December 2018	China New Zealand Singapore Australia	Based on Version 0.3.2, States review and comment on the IGD. This is a revised document according to those comments.
1.0	14 March 2019	China Japan Singapore Malaysia	Consideration by Mode S DAPs WG/2
1.1	17 February 2020	China New Zealand Singapore	Modify based on Version 1.0, States review and comment on the IGD.
2.0	13 May 2020	China	Consideration by Mode S DAPs WG/3
3.0	March 2021	China	

2. ACRONYMS LIST

AA	Aircraft Address
AC	Altitude Code
ACID	Aircraft Identification
ADS-B	Automatic Dependent Surveillance-Broadcast
AICB	Air-Initiated Comm-B
AIP	Aeronautical Information Publication
ANC	Air Navigation Conference
ANSP	Air Navigation Service Provider
APAC	Asia Pacific
ATC	Air Traffic Control
ATM	Air Traffic Management
ATN	Aeronautical Telecommunications Network
ATS	Air Traffic Service
ATSEP	Air Traffic Safety Electronic Personnel
BDS	Comm-B Data Selector
CA	Capability
CDTI	Cockpit Display Traffic Information
CFL	Cleared Flight Level
CLAM	Cleared Level Adherence Monitoring
CNS	Communications, Navigation and Surveillance
DAPs	Downlink Aircraft Parameters
DF	Downlink Format
EASA	European Aviation Safety Agency
EHS	Mode S Enhanced Surveillance
ELM	Extended Length Message
ELS	Mode S Elementary Surveillance
ES	Extended Squitter
EUROCAE	European Organization for Civil Aviation Equipment
EUROCONTORL	European Organization for the Safety of Air Navigation
FIR	Flight Information Region
FLTID	Flight Identification (transmitted by aircraft)
FMS	Flight Management System
FS	Flight Status
FRUIT	False Relies Unsynchronized In Time
GICB	Ground-Initiated Comm-B
HMI	Human Machine Interface
IC	Interrogator Code
ICAO	International Civil Aviation Organization
ID	Identity
IFR	Instrument Flight Rules
II	Interrogator Identifier
IRF	Interrogation Repetition Frequency
MHz	Megahertz
MIP	Mode Interlace Patterns
MIT	Massachusetts Institute of Technology
MLAT	Multilateration
MSAW	Minimum Safe Altitude Warning
MSP	Mode S Specific Protocol
MTCD	Medium Term Conflict Detection
SARPs	(ICAO) Standards and Recommended Practices
SFL-	Selected Flight Level

SI	Surveillance Identifier
SSR	Secondary Surveillance Radar
STCA	Short-Term Conflict Alert
UTC	Universal Time Coordinated
WAM	Wide Area Multilateration
WG	Working Group

3. REFERENCE DOCUMENTS

Id	Name of the document	Edition	Date	Origin	Domain
1	Aeronautical Telecommunications, Annex 10 - Vol. III - Communication Systems	Edition 2	2007	ICAO	
2	Aeronautical Telecommunications, Annex 10 - Vol. IV - Surveillance Radar and Collision Avoidance Systems	Edition 5	2014	ICAO	
3	Doc 9871, Technical Provisions for Mode S Services and Extended Squitter.	Edition 2	2012	ICAO	
4	Doc 9688 Manual on Mode S specific service.	Edition 2	2004	ICAO	
5	ED-73E, Minimum Operational Performance Standards for Secondary Surveillance Radar Mode S Transponders.	Edition 1	May 2011	EUROCAE	
6	ADS-B Implementation and Operations Guidance Document	Edition 11	April 2018	ICAO APAC	
7	Concept of Operations Mode S in Europe (Mode S CONOPS)	Edition 2	November 2013	Eurocontrol	
8	Mode S Elementary Surveillance (ELS) Operations Manual	Edition 1	January 2011	Eurocontrol	
9	Asia/Pacific Seamless ATM Plan		May 2015	ICAO APAC	
10	Doc 9924 Aeronautical Surveillance Manual	Second Edition	2017	ICAO	
11	Preliminary System Safety Analysis for the Mode S Elementary Surveillance	Edition 1.8	April 2004	Eurocontrol	EATMP
12	Elementary Surveillance (ELS) and Enhanced Surveillance (EHS) validation via Mode S Secondary Radar		April 2008	MIT Lincoln Laboratory	ATC Project
13	Aircraft Derived Data Validation Algorithms		August 2012	MIT Lincoln Laboratory	ATC Project
14	Doc.4444 Procedures For Air Navigation Services Air Traffic Management	Sixteenth Edition	November 2016	ICAO	
15	Clarification Mode S Transponder in an Airport/A-SMGCS Environment	Edition 1.1	3 May 2005	Eurocontrol	

16	Minimum Operational Performance Standards for Air Traffic Control Radar Beacon System /Mode Select (ATCRBS / Mode S) Airborne Equipment	Edition E	17 March 2011	RTCA	
17	MARK 4 AIR TRAFFIC CONTROL TRANSPONDER (ATCRBS/MODE S)	Edition 4	15 November 2011	ARINC	

4. DESCRIPTION OF MODE S DAPs DATA

Inside the aircraft transponder, DAPs are stored in different BDS Registers for responding to DAPs interrogation requests by a Mode S ground system. Aircraft parameters are periodically delivered from aircraft sensors, flight management system, etc., to these registers via the downlink standard length transaction interface. BDS Registers, which have not been updated within the specified maximum update interval, are cleared or indicated as invalid and such aircraft parameters would be unavailable for ground interrogations. When a Mode S SSR sends an interrogation requesting the downlink of registers, DAPs are packed into Comm-B format (known as “MB” field) and are extracted using either the GICB protocol or Mode S specific protocols (MSPs) channel 3.

BDS Registers are identified by a two-digit hex number. For example, BDS Register for selected vertical intention, which is identified by hex number 40₁₆, is commonly written as BDS code 4, 0 in publications. Depending on the stage of Mode S implementation, i.e. Mode S ELS and Mode S EHS, the scope of Mode S DAPs data involved would be different as illustrated in the following subsections.

Detailed data format and maximum update interval of each BDS register are given in “ICAO Doc 9871 - Technical Provisions for Mode S Services and Extended Squitter”.

4.1 Mode S ELS

In Mode S ELS implementation, aircraft and ground Mode S system should be compliant ~~of~~ with providing the following functionalities over ~~traditional~~ conventional Mode A/C systems:

- a) Selective interrogation;
- b) Use of ICAO Aircraft Address;
- c) Automatic reporting of ACID;
- d) Report of transponder capability;
- e) Altitude reporting with a resolution of 25ft (subject to aircraft capability);
- f) Provision of flight status to indicate airborne or on-the-ground (subject to aircraft capability);
- g) Report of SI Code capability; and
- h) ACAS active resolution advisory report (when equipped with TCAS)

DAPs associated with Mode S ELS are stored in BDS code 1,0, BDS code 1,7, BDS code 2,0 and BDS code 3,0 registers of the aircraft’s transponder.

Table 4-1 DAPs in Mode S ELS

Register	Name	Usage
BDS code 1,0	Datalink Capability Report	To report the data link capability of the Mode S transponder/data link installation.
BDS code 1,7	Common Usage GICB Capability Report	To indicate common usage GICB services currently supported.
BDS code 2,0	Aircraft Identification	To report aircraft identification to the ground.
BDS code 3,0	ACAS Resolution Advisory Report	To report ACAS active resolution advisory

With the above functionalities properly configured, Mode S ELS could bring the following benefits to ATC operations:

- a) Provide unambiguous aircraft identification using the unique aircraft address and aircraft identification;
- b) Help to solving Mode 3/A code shortage in congested airspace, using the Mode S conspicuity code (A1000) instead of discrete Mode 3/A codes;
- c) Improve surveillance data integrity by;
 - 1) reducing synchronous garble*,
 - 2) lessening over-interrogations, and
 - 3) simplifying aircraft identification in case of false targets;
- d) Improve the accuracy of multi-surveillance tracking and safety nets with more accurate target detection from Mode S radars and high resolution in altitude reporting; and
- e) Able to process more aircraft tracks than conventional Mode A/C radars; and
- f) Able to provide ACAS active resolution advisory from suitably equipped aircraft.

*Note, while Mode S will help to reduce data garble it will not ~~totally~~ resolve the issue. Issues around multi-path and different transponder types in close proximity (e.g. Mode A/C near a Mode S transponder) mean that the return received by the radar may not be correct. In the case of a Mode A/C transponder close to a Mode S transponder, instances have been recorded where the Mode S address has been transposed into the reply from the Mode A transponder.

4.2 Mode S EHS

Mode S EHS implementation includes all the features of Mode S ELS with the addition of DAPs stored in BDS code 4,0, BDS code 5,0 and BDS code 6,0 registers of the aircraft's transponder. The following table summarizes the details of DAPs of these three registers:

Table 4-2 DAPs in Mode S EHS

Register	Name/Downlink Aircraft Parameters		Usage
BDS code 4,0	Selected Vertical Intention	MCP/FCU Selected Altitude	To provide information about the aircraft's current vertical intentions
		FMS Selected Altitude	
		Barometric Pressure Setting	
		MCP/FCU Mode	
		Target Altitude Source	
BDS code 5,0	Track and Turn Report	Roll Angle	To provide track and turn data to the ground systems.
		True Track Angle	
		Ground Speed	
		Track Angle Rate	
		True Air Speed	
BDS code 6,0	Heading and Speed Report	Magnetic Heading	To provide heading and speed data to ground systems.
		Indicated Air Speed	
		Mach Number	
		Barometric Altitude Rate	
		Inertial Vertical Velocity	

In addition to those improvements contributed by Mode S ELS in Section 4.1, Mode S EHS implementation provides the following benefits to ATC operation:

- a) Further improve multi-surveillance tracking accuracy and performance through the use of DAPs on track, turn, speed and heading of the aircraft in the track calculation;
- b) Further improve the accuracy of safety nets, e.g. Short-Term Conflict Alert (STCA), through the provision of more accurate aircraft tracks, and **Medium Term Conflict Detection (MTCD), Minimum Safe Altitude Warning (MSAW)**, through the provision of the earlier judgment of vertical movement;
- c) Allow the implementation of new safety nets in ATM automation system for cross-checking selected aircraft vertical intention (i.e. Selected Altitude) with ATC controllers' instruction as well as verifying the barometric pressure setting applied in the aircraft with QNH setting in ATM automation system; and
- d) Improve situational awareness of ATC controllers by enabling the direct access of aircraft parameters in ATM automation system, e.g. Indicated Air Speed, **Mach speed**, Selected Altitude, Barometric Pressure Setting, etc.;
- e) Progressive reduction of R/T workload per aircraft.

4.3 DAPs Data Exchange Protocol Between Surveillance and ATM Automation System

The decoding of DAPs data from downlink messages is handled by ground surveillance equipment such as radars, ADS-B, MLAT and WAM ground stations. The Surveillance Data Processor (SDP) within the ATM automation system can combine multiple downlink messages into a single target report for display to controllers. All Purpose Structured EUROCONTROL Surveillance Information Exchange (ASTERIX) formats are commonly used as the protocol for target report transmission from surveillance systems to the ATM automation system.

For detailed information about ASTERIX formats please refer to the following link of EUROCONTROL web site:

<https://www.eurocontrol.int/asterix>

ASTERIX formats are categorized based on the types of surveillance data involved. ASTERIX Category 20, ASTERIX Category 21 and ASTERIX Category 48 are responsible for the DAPs data transmission from MLAT systems, ADS-B systems and radars respectively. For each ASTERIX category, the protocol format is further divided into different editions with variations on the supported DAPs data. ANSP's should carry out appropriate studies on the available protocol editions during the design stage to ensure the chosen format can cater for the scope of DAPs proposed to be implemented and that the Surveillance and ATM automation systems can correctly process the protocol selected.

For details, previous and current versions of ASTERIX Category 20, Category 21 and Category 48 specification documents can be downloaded from the following link of EUROCONTROL web sites:

<https://www.eurocontrol.int/publications/cat020-multilateration-mlt-messages-part-14>

<https://www.eurocontrol.int/publications/cat021-automatic-dependent-surveillance-broadcast-ads-b-messages-part-12>

<https://www.eurocontrol.int/publications/cat048-monoradar-target-reports-part-4-next-version-cat-001>

<https://www.eurocontrol.int/publication/cat020-eurocontrol-specification-surveillance-data-exchange-ast-erix-part-14-category-20>

<https://www.eurocontrol.int/publication/cat021-eurocontrol-specification-surveillance-data-exchange-ast-erix-part-12-category-21>

<https://www.eurocontrol.int/publication/cat048-eurocontrol-specification-surveillance-data-exchange-ast-erix-part4>

5. IMPLEMENTATION PRINCIPLES AND PHASES

Implementation guidance is developed to progress the DAPs implementation from concept to operational use in **the** ICAO APAC region. In this chapter, section one addresses the implementation principles, which describes the issues of international coordination, system compatibility, data integrity and system integration, while section two addresses the implementation phase, to assist States with the management of DAPs implementation activities.

5.1 Implementation Principles

5.1.1 Stakeholders Coordination

DAPs provide useful information from aircraft which can benefit ANSP and airspace users. Improvements in efficiency and safety can be achieved, however the resultant changes in operational procedures to provide the improvements, will affect ANSPs, Regulators, Airlines, and other related airspace users. Before implementation by any States, a coordination team should be formed to study, coordinate, support and consult the implementation plans and related activities. The coordination team should include field experts on avionics, data link, surveillance infrastructures and end users.

Changes in the ATM operational procedures as the result of the use of DAPs requires coordination among ATS providers, Regulators, Airlines, and where applicable, coordination among neighboring States to maximize the benefits. All States are encouraged to share their operational experiences, and to report anomalies through Mode S DAPs WG and the Surveillance Implementation Coordination Group.

Not all Surveillance and ATM automation systems are capable of processing and using DAPs, therefore investment in all related fields needs to be considered by all States. The coordination team should be consulted for ~~the~~ future investment plans and related activities considering the technical and operational aspects. Consideration needs to be given to achieve a balance between investment and benefits.

5.1.2 System Compatibility

a) Technical:

DAPs can be obtained by different surveillance technologies such as Mode S Radar, ADS-B, MLAT and WAM, however not all the transponders can support DAPs. Different surveillance technologies in **the** ICAO APAC States mean that system compatibility should be considered.

Potential interference between different surveillance technologies should be fully considered before implementation, otherwise the efficiency and safety of the system cannot be ensured. Harmonization between different technologies should be considered and optimized to reduce the RF congestion on 1030MHz and 1090MHz.

Since not all aircraft are equipped with Mode S transponders, and not all the Mode S transponders **have** the ability to support DAPs, compatibility and efficiency should always be considered before implementation.

When DAPs are implemented, the data rate will increase compared to the conventional radar data, and the related BDS information extraction strategies should be considered. To reduce **the** load on the 1090MHz spectrum, only those registers intended for operational use should be interrogated/extracted.

b) Operational:

Different processing systems can support DAPs in different levels, hence the quality and information of **the** target may be different after the processed DAPs **have** been added. For example, some radar

tracking algorithms will consider DAPs as an input to the tracking, so the quality and information of the target will be a little bit different, therefore there should be compatibility considerations between different systems before use of the target data.

There are different air traffic management and operation strategies used by neighboring States. So, the operational procedures should always consider the operational compatibilities. For example, Mode A/C transponders and Mode S transponders may be working in the same area.

5.1.3 DAPs Data Integrity

DAPs data integrity should always be the first consideration when putting DAPs data into use. Since the data integrity from the source ~~are~~ **is** not delivered by any related BDS register now, States are encouraged to find a reliable methodology to ensure the data integrity ~~prior to~~ **before** the use of the data. Additionally, ongoing means of determining data integrity should be implemented, along with an ability to exclude invalid DAPs data from ATM automation systems.

States which already have experience on data integrity are encouraged to share this information with other States. The coordination team could support and harmonize this activity, and provide a standard method to evaluate the data integrity, and share the method **with** ~~to~~ all the States.

5.1.4 System Integration

By introducing DAPs, the target characteristic from the source to the end user may be different compared to pre-DAPs implementation. In different phases of the processing flow of target data, DAPs can be used by different systems to improve tracking performance. Some key points in the data flow are as follows:

a) Airborne Avionics Systems

As DAPs data comes from different kinds of sensors and avionics systems on the aircraft, the reliability of the data should be ensured before the data is used operationally. Research has shown that some BDS data is missing or not updated correctly. The reasons for this needs to be established, as it can mean that **the** use of some DAPs data is not suitable for implementation. Examples of issues include:

- 1) Older Flight Management Systems which do not provide all the DAPs data, and
- 2) Incorrect installation (e.g. onboard equipment wired to wrong registers)

b) Ground Sensor Systems

Ground sensors may use the DAPs to improve their target tracking performance, having an impact on the tracking function; the target data produced by this kind of sensors will show different characteristics to the pre-DAPs implemented tracking function, such as the turning rate, the kinematic movement and so on. Data users need to be aware of this performance improvement.

c) Ground Automation Systems

Ground automation systems can use DAPs information for a wide variety of uses, such as for tracking, safety net processing, situational awareness, en-route meteorological information sharing and so on. Ensuring DAPs information is processed and used in an appropriate way should be considered during implementation.

d) Other Surveillance Systems

Any DAPs data should be capable of being integrated with other surveillance systems data, and any potential difference and impact should be considered before use. Some of the information can be cross checked by different surveillance technologies.

- e) Other Related Systems

5.2 Implementation CHECKLIST

The purpose of this implementation checklist is to document the range of activities that needs to be completed to bring a DAPs application from an initial concept to operational use. Some activities of this checklist may be specific to individual stakeholders.

5.2.1 Activity Sequence

The activities are listed in an approximate sequential order. However, each activity does not have to be completed prior to starting the next activity. In many cases, a parallel and iterative process should be used to feed data and experience from one activity to another. It should be noted that not all activities will be required for all applications.

5.2.2 Concept Phase

- a) Construct operational concept:
 - 1) Purpose;
 - 2) Operational environment;
 - 3) ATM functions; and
 - 4) Infrastructure;
- b) Identify benefits:
 - 1) Safety enhancements;
 - 2) Efficiency;
 - 3) Capacity;
 - 4) Environmental;
 - 5) Cost reductions;
 - 6) Accessibility; and
 - 7) Other metrics (e.g. predictability, flexibility, usefulness);
- c) Identify constraints:
 - 1) Air-Ground interoperability;
 - 2) Compatibility with non-equipped aircraft;
 - 3) Need for exclusive airspace;
 - 4) Required ground infrastructure;
 - 5) RF spectrum;
 - 6) Integration with existing technology;
 - 7) Technology availability; and
 - 8) Actuality of existing infrastructure;

- d) Prepare business case:
 - 1) Cost benefit analysis; and
 - 2) Demand and justification.

5.2.3 Design Phase

- a) Identify operational requirements:
 - 1) Security; and
 - 2) Systems interoperability;
- b) Identify human factors issues:
 - 1) Human-machine interfaces;
 - 2) Training development and validation;
 - 3) Workload demands;
 - 4) Role of automation vs. role of human;
 - 5) Crew coordination/pilot decision-making interactions; and
 - 6) ATM collaborative decision-making.
- c) Identify technical requirements:
 - 1) Standards development;
 - 2) Prevailing avionics standards;
 - 3) Data required;
 - 4) Functional processing;
 - 5) Functional performance;
 - 6) Required certification levels; and
 - 7) Identify the infrastructure that needs upgrade.
- d) Equipment development, test, and evaluation:
 - 1) Prototype systems built to existing or draft standards/specifications;
 - 2) Upgrade and test scheme for the existing infrastructure;
 - 3) Developmental bench and flight tests;
 - 4) Acceptance test parameters; Acceptance test should be performed to ensure all the key indicators are met; and
 - 5) Select and procure technology.
- e) Develop procedures:
 - 1) Pilot and controller actions and responsibilities;
 - 2) Standardize the interaction and phraseologies;
 - 3) Controller's responsibility to maintain a monitoring function, if appropriate;
 - 4) System certification procedure should be made.
 - 5) Standard Operating Procedure should be made if the human machine interface of the system is changed.

- 6) Contingency procedures; For example duplicate Mode S address is detected;
 - 7) Emergency procedures, for example ACAS message is received;
 - 8) General procedures for unforeseen issues should be made; and
 - 9) Develop AIP and Information documentation.
- f) Prepare design phase safety case:
- 1) Safety rationale;
 - 2) Safety budget and allocation; and
 - 3) Functional hazard assessment.

5.2.4 Implementation Phase

- a) Prepare implementation phase safety case;
- b) Conduct operational test and evaluation:
 - 1) Flight deck and ATC validation simulations; and
 - 2) Flight tests and operational trials;
- c) Obtain systems certification:
 - 1) Aircraft equipment; and
 - 2) Ground systems;

- d) Obtain regulatory approvals:
 - 1) Air traffic certification of use;

- e) Impact Assessment

An impact assessment should be conducted to gauge the effect in terms of security, efficiency, operating regulations, human factors, infrastructure, environment, and so on.

- f) Implementation transition:

- 1) Promulgate procedures;

The regulatory authority shall promulgate general regulations to the participants. Each participant shall formulate corresponding detailed regulations.

- 2) Deliver training;

Training should be conducted to ensure the personnel are familiar with the standard, regulation, and technology of the Mode S DAPs implementation and operation. Licensing process could be executed if needed.

- 3) Continue data collection and analysis;
- 4) Resolve any unforeseen issues; and
- 5) Continue feedback into standards development processes;

- g) Performance monitoring to ensure that the agreed performance is maintained.

6. SYSTEM INTEGRITY AND MONITORING

6.1 Introduction

CNS and ATM environment is an integrated system including physical systems (hardware, software, and communication networks), human elements (pilots, controllers and engineers), and the operational procedures for its applications. The integration of Mode S DAPs with other surveillance technologies enables more information from an aircraft to be used to provide a safer service.

Because of the integrated nature of such system and the degree of interaction among its components, comprehensive system monitoring is recommended. The procedures described in this section aim to ensure system integrity by validation, identification, reporting and tracking of possible problems revealed during system monitoring with appropriate follow-up actions.

6.2 Personnel Licensing and Training

Prior to operating any element of the Mode S DAPs system, operational and technical personnel shall undertake appropriate training as determined by the ANSP or State Regulatory Authority, including compliance with the Convention on International Civil Aviation where applicable. ~~With these the~~ **Such training will ensure that** personnel ~~will be~~ **are** familiar with ~~the~~ regulation, standards and requirements of the Mode S DAPs implementation and operation.

6.3 ATS System Validation

6.3.1 Safety Assessment Guidelines

To meet system integrity requirements, ANSPs or States should conduct a validation process that confirms the integrity of their equipment and procedures. Such processes shall include:

- a) A system safety assessment for new implementations is the basis for definitions of system performance requirements. Where existing systems are being modified to utilize additional services, the assessment demonstrates that the ATS Provider's system will meet safety objectives.
- b) Integration test results confirming interoperability for operational use of airborne and ground systems; and
- c) Confirmation that the ATS operation procedure ~~are~~ **is** compatible with those of adjacent providers where the system is used across a common boundary.

6.3.2 System Safety Assessment

The objective of the system safety assessment is to ensure that ~~the~~ implementation and operation of Mode S DAPs ~~is~~ **are** safe. The safety assessment should be conducted for implementation as well as any future enhancements and should include:

- a) Identifying failure or error conditions;
- b) Assigning levels of criticality;
- c) Determining risks/probabilities for occurrence;
- d) Identifying mitigating measures;

- e) Categorizing the degree of acceptability of risks; and
- f) Operational hazard ID process.

Following the safety assessment, States should institute measures to offset any identified failure or error conditions that are not already categorized as acceptable. This should be done to reduce the probability of their occurrence to an acceptable level. This could be accomplished through the automation of procedures.

6.3.3 Integration Test

States should conduct trials with suitably equipped aircraft to ensure the DAPs data meets the operational and technical requirements to provide ATS. The introduction of the Mode S DAPs will give more information about the aircraft, and should not affect the performance of the existing system. States should be satisfied by test results and analysis carried out by the ANSP.

6.3.4 ATS Operation Manuals

States may coordinate with adjacent States to confirm that their ATS operation manuals contain standard operating procedures to ensure harmonization of procedures that impact across common boundaries.

6.4 System Monitoring

During the implementation and operation of the Mode S DAPs technology, routine collection of data is necessary ~~in order~~ to ensure that the system continues to meet or exceed its performance, safety and interoperability requirements, and that operational service delivery and procedures are working as intended.

6.4.1 Consideration for System Monitoring

Mode S transponders may have been installed a long time ago to support mandatory ACAS functionality. The Mode A/C function has been permanently used by ATC, but the Mode S functions may not have been used. Any failure impacting Mode A/C would have been detected by ATC during normal operation and corrective action would have been undertaken. Before implementing Mode S for surveillance, system checks are usually made to ensure the correct operation of the Mode S transponders (e.g. continue to correctly process Mode A/C and Mode S replies), but possibly no system checks were made to ensure that the DAPs data was correct, so ~~a number of~~ several undetected failures may have existed over the years of operation.

A number of Mode S transponder from different OEMs have been observed to be non-compliant with Annex 10 Volume IV requirements (e.g. no SI code capability, no reply to aircraft register extraction, incorrectly configured aircraft address, incorrect content of BDS registers), even though the transponder is certified to level 2. Although actions have been taken in some areas (mainly where Mode S has been implemented) to address these problems, some aircraft with Mode S which are not working correctly still operate (mostly in areas where Mode S has not yet been implemented).

During the initial deployment of European Mode S, it was discovered that avionics upgrade performed on some aircraft had resulted in erroneous transponder operations so that, in some cases, the aircraft could not even be detected by the ground radar. It is therefore recommended that before commencing Mode S surveillance operations in a given airspace, system monitoring be put in place for ~~the purpose of~~ timely detection and rectification of hidden transponder problems. This will enable the ANSP and aircraft operators to remedy identified issues prior to using Mode S operationally.

The communication lines for transferring surveillance information in a Mode S radar require much higher data throughput as there is more information per aircraft. For example, compared to a Mode A/C radar, Mode S DAPs require up to three times more data throughput.

Mode S DAPs bring safety benefits even when only a portion of the traffic is properly equipped. Some aircraft can be configured to provide additional data items, but their use should be considered with caution since some airborne installations may not have been certified, hence data may be erroneous. System monitoring to validate the transmitted information is considered desirable for DAPs operation.

6.4.2 Mode S DAPs Problem Reports

During the application of the Mode S DAPs, some problems may be found during the observation of one or more specific events. Faulty Mode S DAPs data should be recorded and analyzed. Problems may be found during the routine analysis of application data. Any problem should be documented and reported to the DAPs WG.

After a problem has been found, the finder can attempt to resolve it with the appropriate party and report the solution to the DAPs WG. The problem and solution will be distributed to the DAPs WG members. If the problem has not been resolved, the problem should be reported to the DAPs WG, and members will be encouraged to resolve the problem. In many cases, a Mode S DAPs problem will be systematic across a particular aircraft or avionics configuration. Engagement with, and correction by the manufacturer may be required.

The mode S DAPs problem should be reported with the form as shown in Table 6-1.

Table 6-1 Mode S DAPs Problem Report Form

PRS#			
Start Time/Date UTC		End Time/Date UTC	
Registration		Aircraft ID	
Flight ID		ICAO Aircraft Address	
Aircraft Type			
Flight Sector/ Location			
ATS Unit			
Description / additional information			
Originator		Originator Reference number	
Organization			

- PRS#:** A unique identification number assigned by the PRS Administrator to this problem report. Organizations writing problem reports are encouraged to maintain their ~~own~~ internal list of these problems for tracking purposes. Once the problems have been reported to the PRS and incorporated in the database, a number will be assigned by the PRS and used for tracking by the SURICG.
- Start Time/Date UTC:** UTC time/date when the event ~~occurred~~ **started**.
- End Time/Date UTC:** UTC time/date when the event ended.
- Registration:** Registration number (tail number) of the aircraft involved.
- Aircraft ID:** Coded equivalent of call sign as entered in FPL Item 7.
- Flight ID:** The Flight ID/Flight Number downlinked from the aircraft.
- ICAO Aircraft Address:** Unique aircraft address expressed in Hexadecimal form.

Aircraft Type:	The aircraft model involved. For the aircraft type designators please refer to ICAO Doc 8643.
Flight Sector/Location:	The departure airport and destination airport for the sector being flown by the aircraft involved in the event. These should be the ICAO Identifiers of those airports. For the airport indicators please refer to ICAO Doc 7910 or related AIP. Or if more descriptive, give the location of the aircraft during the event.
ATS Unit:	ICAO identifier of the ATC center or tower controlling the aircraft at the time of the event.
Originator:	Point of contact at the originating organization for this report (usually the author).
Organization:	The name of the organization (airline, ATS provider or communications service provider) that created the report.
Description:	<p>This should provide as complete a description of the situation leading up to the problem as is possible. Where the organization reporting the problem is not able to provide all the information (e.g. the controller may not know everything that happens on the aircraft), it would be helpful if they would coordinate with the other parties to obtain the necessary information. The description should include:</p> <ol style="list-style-type: none">A complete description of the problem that is being reportedThe route contained in the FMS and flight planAny flight deck indicationsAny indications provided to the controller when the problem occurredAny additional information that the originator of the problem report considers might be helpful but is not included on the list above <p>If necessary, to contain all the information, additional pages may be added. If the originator considers it might be helpful, diagrams and other additional information (such as printouts of message logs) may be appended to the report.</p>

6.4.3 Example of Mode S DAPs Problem

Through monitoring, it has been reported that erroneous DAPs data have been observed due to failure or improper setting/installation of Mode S equipment. A Working Paper of the ICAO Surveillance Panel Working Group (WP ASP12-20) has indicated that a lot of incorrect, outdated and even erroneous data and parameters are present for DAPs data. The errors and/or miss-matches can be frequent, including:

- The ACID is not always correct (erroneous)
- The Selected Altitude is not correct or is not updated (For example Selected Altitude data should be provided **by** the MCP/FCU ~~not by~~ **instead of** the FMS as the FMS data is usually incorrect).
- Mode S DAPs data does not correspond to the content of the requested register (**BDS swap**).

6.5 Application Analysis

During the Operation of Mode S DAPs **application**, the ~~application~~ analysis is necessary to ensure that the system continues to meet or exceed its performance, safety and interoperability requirements. To analyze the Mode S DAPs applications, routine data should be recorded.

6.5.1 Data Recording

It is recommended that ATS providers and communication service providers retain the records defined below for at least 30 days to allow for accident/incident investigation processes. These records should be made available on request to the relevant State safety authority. Where data is sought from an adjacent State, the usual State to State channels should be used.

Where possible these recordings shall be in a form that permits a replay of the situation and identification of the messages that were received by the ATS system. Data exchange across borders may not be possible due to different Radar or ATM message formats or to State regulatory issues.

Not only the data from ground equipment, but also the data from aircraft equipment should be recorded. By analyzing the recorded data, the exact reason ~~of~~ **for** the failures can be found.

6.5.2 Local Data Collection

ATS providers and communication service providers should identify and record Mode S DAPs system component failures that have the potential to negatively impact the safety of controlled flights or compromise service continuity.

6.5.3 Avionics Problem Identification and Correction

ATS providers should develop systems or procedures to:

- a) detect Mode S DAPs avionics anomalies and faults
- b) advise the regulators and where appropriate the aircraft operators on the detected Mode S DAPs avionics anomalies and faults
- c) devise mechanisms and procedures to address identified faults

Regulators should ensure that appropriate corrective actions are taken to address identified faults.

An example of Mode S DAPs analysis is taken in Appendix 1.

6.6 Identified Issues

Several identified issues had already been recognized during the implementation of the Mode S DAPs data application in **the** ATM automation system. Some of them even disrupted the operation of ATC services. Thus, it is necessary to ensure the reliability of DAPs for utilization for ATC operation. This section will present some issues for helping to figure them out.

Based on the experience gained from States, the common Mode S DAPs problems are summarized under different categories in Appendix 2. It is noted that many cases of **the** wrong DAPs found in Mode S implementation were because of the aircraft avionics capability. ~~There are also some issues that resulted of~~ **Some issues resulted form** human factors. Experiences showed that it was important to keep close coordination with airlines to promote the DAPs application. Airlines should be informed of the issues in time and to check their aircraft Mode S transponders ~~in a timely manner~~ **promptly**. At the same time, airlines need **to** improve their working procedures including ensuring they file flight plans correctly.

7. REGULATIONS AND PROCEDURES

Mode S DAPs involves the transmission of specific data from aircraft. These data messages can be interrogated by the ground equipment called Mode S interrogator. ATM uses the data to show the more precise and integrated situation of the surveillance aircraft. The following procedures relate to the use of Mode S DAPs data in ATS ground surveillance applications.

The implementation of the Mode S DAPs system will support the provision of high-performance surveillance, enhancing flight safety, improving the controller efficiency and reducing the workload of both the controller and pilot.

7.1 Mandating Mode S DAPs

- a) Depending on the type of operations that States are going to conduct, States will have to consider whether there is a need to publish mandates. Some operations will require all aircraft within an airspace to be suitably equipped while others can still work well on a ‘best equipped best served’ basis.
- b) Use of Multilateration on airport surface is an example of an operation where it is recommended for all aircraft to be equipped with Mode S transponders. Another example is the conspicuity code environment, where Flight Identification may be used as the prime means to couple flight plans, allowing ANSPs to overcome the shortage of Mode A codes. Equipage mandates would be necessary for such operations.
- c) With appropriate software, ATM automation systems can use Mode S DAPs to provide additional information to controllers, enabling a reduction in controller workload and the enhancement of Safety Net systems. Equipage mandates are not necessary, but consideration of the nature of the services required and/or a cost-benefit study, may warrant such mandates.
- d) As at of May 2018, examples of States which use Mode S DAPs without publishing mandates are Australia¹, New Zealand and Singapore. Examples of States with published mandates for Mode S DAPs are France, Germany and the United Kingdom.
- e) In publishing mandate/regulations, States should:
 - 1) Define the standards applicable to the State.
 - i. E.g. *Joint Aviation Authorities (JAA) Temporary Guidance Leaflets (TGL) 13 Revision 1* for Elementary Surveillance in version 0 and version 1 transponders; or
 - ii. E.g. *European Aviation Safety Agency (EASA) Acceptable Means of Compliance (AMC) 20-13* for Enhanced Surveillance in version 0 and version 1 transponders; or
 - iii. E.g. *Elementary Surveillance (ELS) requirements stated in European Aviation Safety Agency (EASA) CS-ACNS-Subpart D, Section 2 (i.e. CS ACNS.D.ELS)* for Elementary Surveillance in version 2 transponder; or
 - iv. E.g. *Enhanced Surveillance (EHS) requirements stated in European Aviation Safety Agency (EASA) CS-ACNS-Subpart D, Section 3 (i.e. CS ACNS.D.EHS)* for Enhanced Surveillance in Version 2 transponder
 - v. E.g. *Mode S level 2* if the requirement is simply for Airport Surface Multilateration.
 - 2) Define the airspace affected by the regulations

¹ Australia has a mandate for Mode S transponders at selected airports utilizing Multilateration for surface surveillance, but no widespread mandates for airborne DAPs usage

- i. E.g. *Within the [FIR Authority] Flight Information Region above Flight Level XXX*
- 3) Define the category of aircraft that the regulation applies to
 - i. E.g. *Aircraft with a maximum certified take-off mass exceeding 5,700 kg or having a maximum cruising true airspeed capability greater than 250 kt; or*
 - ii. E.g. *All IFR aircraft*
- 4) Define the timing of the regulations allowing sufficient time for operators to equip.
 - i. E.g. *With effect from 1 Jan 2020.*

7.2 Avionics

7.2.1 Mode S Transponder Capabilities

- a) The various levels of capabilities for Mode S Transponders are described in subsequent paragraphs. ~~State~~**The state** should select the capability as required by its operations.
- b) According to ICAO Annex 10, Vol. 4, Mode S transponders shall conform to one of five levels of capability as follows:
 - 1) Level 1 is the basic transponder. Level 1 permits surveillance based on Mode A/C as well as on Mode S. With a Mode S aircraft address, it comprises the minimum features for compatible operation with Mode S interrogators. It has no datalink capability and will not be used by international air traffic.
 - 2) Level 2 has the same capabilities as Level 1 and permits standard length datalink communication from ground to air and air to ground. It includes automatic aircraft identification reporting. This is the minimum level permitted for international flights. Data parity with overlay control (ICAO Annex 10, Vol. 4, 3.1.2.6.11.2.5) for equipment certified on or after 1 January 2020.
 - 3) Level 3 has the capabilities as level 2 and also those prescribed for ground-to-air ELM communications.
 - 4) Level 4 has the capabilities as level 3 and also those prescribed for air-to-ground ELM communications.
 - 5) Level 5 has the capabilities as level 4 and also those prescribed for enhanced Comm-B and ELM communications.
- c) Other than the various levels, transponders also can have the following features:
 - 1) Extended squitter - transponders that shall have the capabilities of level 2, 3, 4 or 5 and those prescribed for extended squitter operation.
 - 2) SI Capability - Transponders with the ability to process SI codes shall have the capabilities of level 2, 3, 4 or 5 and those prescribed for SI code operation.
 - 3) Data flash Application – transponders that implement the data flash mode.
 - 4) Hijack Mode Capability – transponders that support the Hijack Mode and have the capabilities of level 2, 3, 4 or 5.
 - 5) ACAS Compatibility –transponders compatible with ACAS.
 - 6) Antenna Diversity – in aircraft with transponder using two antennas, receivers and transmitting channels.
 - 7) According to ED-73E, Elementary Surveillance – elementary surveillance transponders will require at least a level 2 transponder and have the following capabilities:

- i. Flight status reporting;
 - ii. Barometric pressure altitude reporting
 - iii. Transponder capability (CA)
 - iv. II and SI code capable
 - v. Declaration of capability (BDS code 1,0)
 - vi. Common usage GICB capability report (BDS code 1,7)
 - vii. Mode S specific services capability (BDS code 1,8 to BDS code 1,C)
 - viii. Flight identification (BDS code 2,0)
 - ix. ACAS Active Resolution Advisory (BDS code 3,0) if equipped with ACAS II
 - x. Aircraft register (BDS code 2,1) – optional
- 8) According to ED-73E, Enhanced Surveillance – enhanced surveillance transponders have the capabilities of elementary surveillance transponders, plus the capability to provide the following DAPs:
- i. Magnetic Heading (BDS code 6,0)
 - ii. Indicated Airspeed and/or Mach No. (BDS code 6,0)
 - iii. Vertical Rate (climb/descend) (BDS code 6,0)
 - iv. True Airspeed (provided if Track Angle Rate is not available) (BDS code 6,0)
 - v. MCP/FCU Selected Altitude (BDS code 4,0)
 - vi. Ground Speed (BDS code 5,0)
 - vii. Roll Angle (BDS code 5,0)
 - viii. Track Angle Rate (if available) (BDS code 5,0)
 - ix. True Track Angle (BDS code 5,0)
 - x. Barometric Pressure Setting (BDS code 4,0)

7.2.2 Mode S Transponder Mandate

During the 31st APANPIRG meeting, the following Conclusion regarding the fitment of Mode S equipage was adopted, States/Administrations may consider the following conclusion when considering the publishing of Mode S transponder mandate.

Conclusion APANPIRG/31/14 (CNS SG/24/13 (SURICG/5/3(DAPS WG3/1))) - Mode S Forward Fit Equipage in APAC Region [A1]	
<p>What: Regarding fitment of Mode S equipage, That, States/Administrations in APAC Region be strongly encouraged to mandate that registered aircraft with a maximum certified take-off mass exceeding 5 700 kg or having a maximum cruising true airspeed capability greater than 250 knots, with a date of manufacture on or after 1 January 2022 be equipped with Mode S avionics compliant with Enhanced Surveillance (EHS).</p>	<p>Expected impact:</p> <ul style="list-style-type: none"> <input type="checkbox"/> Political / Global <input type="checkbox"/> Inter-regional <input checked="" type="checkbox"/> Economic <input type="checkbox"/> Environmental <input checked="" type="checkbox"/> Ops/Technical
<p>Why: Considering that a number of DAPs applications will require EHS and that it's easy for new aircraft to be equipped with EHS. Retrofitting existing airframes with EHS will need further deliberation under the challenging pandemic situation.</p>	<p>Follow-up: <input checked="" type="checkbox"/> Required from States</p>
<p>When: 16-Dec-20</p>	<p>Status: Adopted by PIRG</p>

Who: Sub groups APAC States ICAO APAC RO APANPIRG ICAO
 HQ Other: SURICG

7.2.3 Transition Guidelines

- a) Equipage of aircraft will be achieved over a period of time. Not all aircraft will be equipped with the necessary capability. A transition plan is required to accommodate varying degrees of aircraft equipment compliance.
- b) As part of the formulation for a transition plan, States should assess the impact of having aircraft that are not suitably equipped within the affected airspace, to enable the implementation of suitable mitigating measures. States should also collect statistics on the readiness of the aircraft within the affected airspace.
- c) For different operations, the mitigation measures in the transition plan could be different. For example, if the operation is just to use the Mode S DAPs to provide useful information to the controllers, the impact of having unequipped aircraft is minor. Mitigating measures could be as simple as making the controllers aware that not all aircraft are able to provide the information. On the other hand, where mode S is mandated for airport surface Multilateration, mitigating measures for having unequipped aircraft may include having special procedures for non-equipped aircraft or the deployment of a surface movement radar.

7.2.4 ~~Interrogation of Transponders on Ground~~ Mode S Transponder Working on the Ground

Table 7-1 summarizes the requirements to inhibit or not inhibit replies from aircraft on the ground.

Table 7-1 The Requirements of ~~Interrogation of Transponders on Ground~~

Type of interrogations	Transponder reply
Mode A/C	Should be inhibited
Mode A/C/S All Call	Shall always be inhibited
Mode S only All Call (UF =11)	Shall always be inhibited
Mode S (Roll call UF=0,4,5,16,20,21,24)	Shall not be inhibited
Acquisition Squitter (Short Squitter)	Shall be inhibited if surface type of extended squitter is transmitted
Extended Squitter (Long Squitter)	Shall not be inhibited

[Information obtained from Eurocontrol’s Clarification Mode S Transponder in an Airport/A-SMGCS Environment Ed 1.1 dated 3 May 2005]

- a) Replies to Mode A/C/S all call and Mode S only all call interrogations shall always be inhibited when the aircraft declares the on the ground state. It shall not be possible to inhibit replies to discretely addressed Mode S interrogations regardless of whether the aircraft is airborne or on the ground.
- b) Mode A/C replies should be inhibited (i.e. Mode A/C transponder set to standby) when the aircraft is on the ground to prevent interference when in close proximity to an interrogator or other aircraft. Mode S discretely addressed interrogations do not give rise to such interference. An exception on the recommendation to inhibit Mode A/C replies will be at airports having Multilateration systems working with Mode A/C.
- c) Mode S transponders shall be set to the correct mode according to its flight status (i.e. airborne

mode when it's in the air and ground mode when on the ground). When an aircraft is in ground mode, replies to all call are inhibited. It is recommended that aircraft provide means to determine the on-the-ground state automatically and provide that information to the transponder.

7.3 Mode S Interrogator

7.3.1 Working Principles

The Mode S interrogator transmits interrogation to elicit replies for detection of Mode S transponders and more information from the aircraft. The use of a unique ICAO 24-bit aircraft address and provision of all the required aircraft data in one reply will reduce interrogation rates.

Each aircraft can be interrogated selectively, needing only one or two 'hits' per aircraft per scan and minimizing interference problems associated with SSR Mode A/C.

The operation of a Mode S interrogator will not interfere with the SSR performance of any aircraft equipped with a Mode A/C transponder.

A Mode S interrogator is capable of performing the conventional surveillance function with Mode A/C transponders.

7.3.2 Interrogator Codes

The Mode S system requires each interrogator to have an IC, which can be carried within the uplink and downlink transmissions. The 4-bit IC uplink field in UF11 shall contain either 4-bit II code or the lower 4 bits of the 6-bit SI codes. It is recommended that whenever possible an interrogator should operate using a single interrogator code.

The II codes shall be assigned to interrogators in the range from 0 to 15. The II code value of 0 shall only be used for supplementary acquisition. The SI codes shall be assigned to interrogators in the range from 1 to 63. The SI code value of 0 shall not be used.

The assignment of interrogator II or SI codes, where necessary in areas of overlapping coverage, across international boundaries of flight information regions, shall be the subject of regional air navigation agreements. The ICAO Asia Pacific Regional Office maintains a register of II codes used where States have provided this information to the office. States are encouraged to provide this information to the Regional Office and update it when changes are made.

7.3.3 Interrogation Methods ~~Mode Interlace Pattern~~

The particular air traffic and environment of each interrogator will influence the selection of suitable interrogation periods, interrogation repeat frequency, MIP and Probability of Reply.

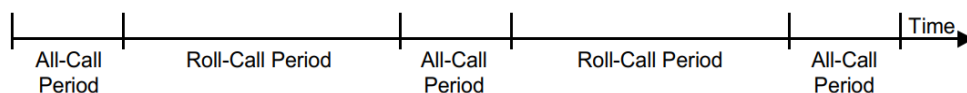

Figure.7-1 The Typical MIP

The repetition frequency and duration of the All-Call period is a local implementation issue (the stated ICAO maximum is 250Hz). The exact duration of either period will depend on the characteristics of the system such as the antenna revolution rate, the beam-width and the maximum range. There will normally

be several all-call periods (and hence roll-call periods as one will always follow the other) available to interrogate all targets in range during one revolution.

There is a careful balance between the reliable acquisition of all targets and the potential of flooding the RF environment with unwanted replies to acquisition interrogations. It is necessary to choose an appropriate Mode Interlace Pattern to manage the acquisition activities to ensure minimal interference. The default objective is to define a MIP which effectively detects and performs surveillance on classical SSR Mode A/C aircraft using Mode A/C interrogations which also detects and acquires Mode S aircraft using Mode S interrogations. The MIP is constructed in order to separate Mode A/C and Mode S all-calls from Mode S selective (roll-call) activity. MIP defines the sequences of all-call interrogation types that might be made during cycles of all-call periods. Every interrogator is likely to have different needs and hence different ways of operating.

China presented an IP about the Mode S Parameter Set during the 3rd meeting of DAPs WG. For detailed information please refer to Appendix 4.

7.3.4 ~~Interrogate Comm-B Data~~DAPs Extraction by GICB Protocol

The GICB procedure is initiated by a Mode S interrogator for eliciting the Mode S DAPs containing aircraft derived data from a Mode S aircraft installation.

The GICB protocol allows for the immediate transfer of data required by the ground and the extraction of information stored in the Mode S transponder. This information (if available) is contained in the reply to an interrogation specifying the address (BDS code) of the storage location containing that information.

The interrogation with specific BDS can elicit the corresponding Comm-B data where contained in Mode S transponder's registers. The Mode S DAPs can be implemented in two stages: ELS and EHS.

The first processing step for any Mode S data link application is to obtain the transponder CA value from the aircraft. The 3-bit CA field is found in the "Mode S All-Call Reply" (DF=11) and the "Extended Squitter" (DF=17) downlinks. If CA=0, then this transponder is surveillance-only and supports no data link functions at all. If CA \geq 4 indicates that the Mode S transponder is fully capable of at least 56-bit short uplink and downlink message transfer. These Mode S transponders may support the ELS, EHS requirements. The values of CA= 1, 2, 3 are reserved.

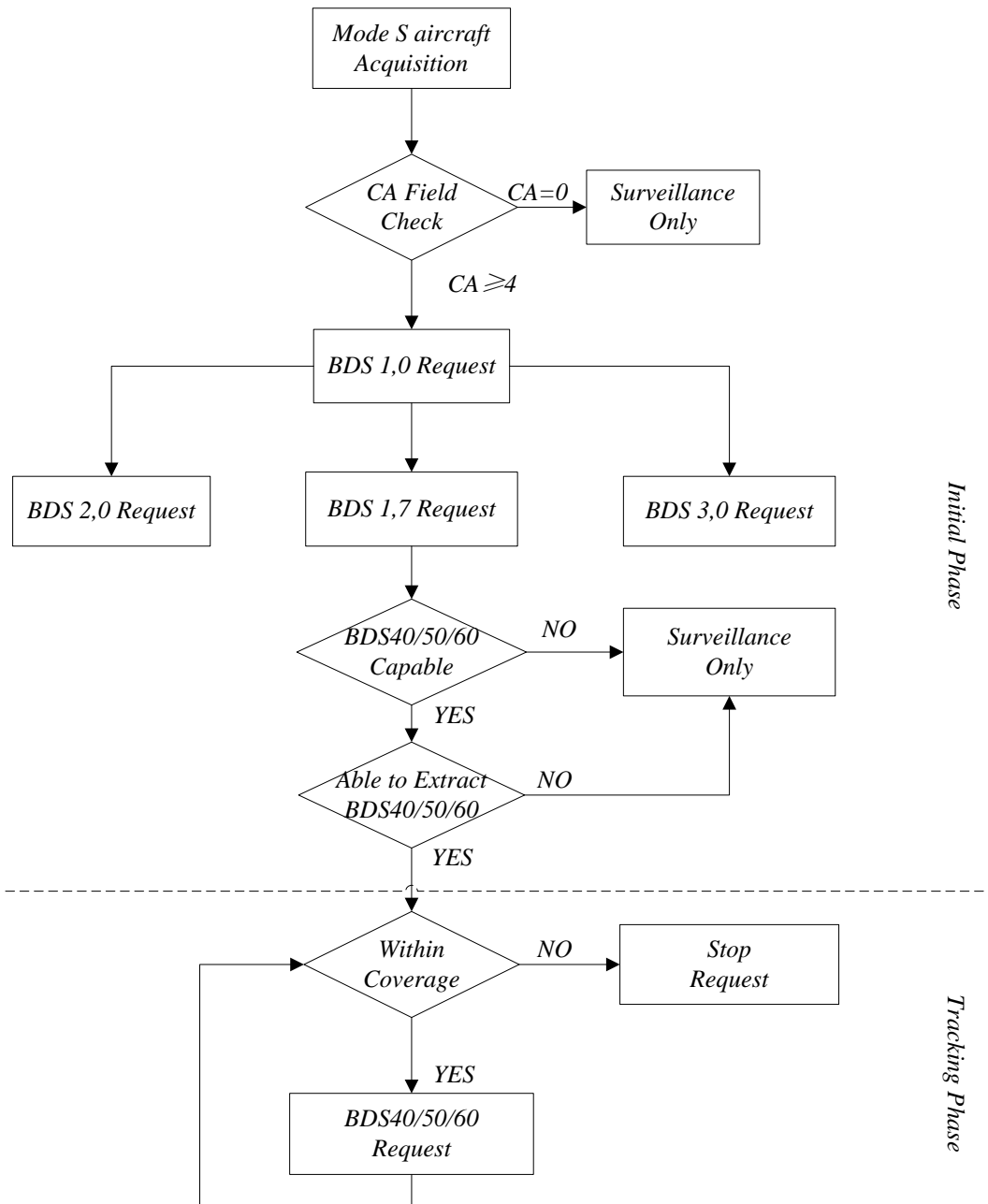

Figure.7-2 The Typical Procedure of DAPs Extraction

Given that the Mode S transponder's CA value is 4 or greater, the second processing step for any Mode S data link application is to extract the transponder's Mode S data link capability report register BDS code 1,0. Bits in this register indicate the support of such Mode S data link functions as aircraft identification (register BDS code 2,0), ACAS (register BDS code 3,0), common-usage capability (register BDS code 1,7) etc. The Mode S-Specific services capability bit in register BDS code 1,0 indicates whether the avionics installation supports further data link functions. If this bit is set, the Mode S data link application would next extract the common-usage capability register BDS code 1,7. All of the registers involved with the EHS application have bit flags assigned in this register BDS code 1,7. If the bit flag is set, it indicates that the corresponding register has been updated in a timely manner and contains valid data which can be extracted by the interrogator. The processing protocol is sufficient initialization for basic data link applications such as ELS, EHS since all their status and configuration information is available from register BDS code 1,0 and register BDS code 1,7.

So, the Mode S interrogator should transmit the selectively interrogation to elicit the Mode S transponder reply with the specific formats and Comm-B data contained in the corresponding registers.

Normally, the more Comm-B data requested by the Mode S interrogator, the more information can be extracted from the aircraft transponder registers. It will also help the ATC controller get the aircraft's flight status and flight intention. However, there should be some necessary limitations for the Comm-B data request to avoid the phenomenon of Comm-B data discontinuity because of the limited Roll-Call interrogation duration.

It is suggested that the number, periodicity and priority of BDS data extraction rule be reasonably and effectively implemented according to the requirements and the number of aircraft in the airspace. The scientific strategy can ensure the ATC controller gets Comm-B data timely and effectively.

7.3.5 DAPs Extraction by AICB Protocol

The AICB procedure is initiated by a Mode S transponder for transmitting a single Comm-B segment from the aircraft installation.

Any changes in the contents of ACAS (register BDS code 3,0) triggers a downlink message via the air-initiated Comm-B broadcast protocol including the updated register contents.

An AICB sequence shall start upon the acceptance of a message intended for delivery to the ground sensor. After receipt of this message, the transponder shall set a valid downlink request code of surveillance or Comm-B reply. On receipt of this message with a valid downlink request code, the interrogator could start to extract the message.

AICB messages are announced by the transponder and are transmitted in a subsequent reply only after authorization by the interrogator. AICB messages are announced to all interrogators and can be extracted by any interrogator. The Mode S data link application should update the aircraft's "state" values with the new ones. The changed state might result in discontinuance (or reinstatement) of certain Mode S data link functions. Mode S transponder AICB broadcast messages are held active in the transponder for 18 seconds after the triggering event. Any Mode S sensor can extract the broadcast information.

7.3.6 DAPs Extraction by Comm-B Broadcast

A Comm-B broadcast is a message directed to all active interrogators in view. Messages are available for 18 seconds unless a waiting AICB interrupts the cycle. Interrogators have no means to cancel the Comm-B broadcast.

Currently, only registers of datalink capability report (register BDS code 1,0) and aircraft identification (register BDS code 2,0) make use of the Comm-B Broadcast.

7.4 ATM Automation System

7.4.1 Elementary Surveillance

For the Elementary Surveillance, the following parameters of aircraft can be beneficial to the ATM automation system:

- a) ICAO 24-bit Aircraft Address/Aircraft Identification

- 1) The ATM automation system should collect the real aircraft address/aircraft identification from the received message, and the aircraft address/aircraft identification can be shown on the control HMI to identify the aircraft.
- 2) The ATM automation system can use the aircraft address/aircraft identification to correlate an aircraft's track with the flight plan, so the use of aircraft address/aircraft identity can alleviate the shortage of Mode 3/A code. Correlation between track and flight plans is normally based on either the 24-bit aircraft address, aircraft identification, or the Mode 3/A code. The correlation will depend on their weights and priority.
- 3) The ATM automation system can also utilize the aircraft address/aircraft identification to improve the tracking function.
- 4) The ATM automation system could provide DUPE warning between aircrafts which have the same ICAO 24-bit aircraft address, same aircraft identification or the same Mode 3/A code.

b) Transponder Capability Report

The ATM automation system can collect the datalink capability of the transponder from the received message and show the information to the controller. The controller can estimate whether the aircraft with this transponder meets the requirement in the airspace

c) Altitude reporting in 25ft interval

The ATM automation system can collect aircraft altitude reporting in 25ft increments and provides valuable improvements to the quality of safety nets. The improvements should reduce the number of nuisance alerts and enhance the integrity of separation assurance.

d) Flight status (airborne/on the ground)

The ATM automation system can collect the flight status of the aircraft. Whether the aircraft is airborne or on the ground can be shown in the system to improve the situational awareness of the controller. Also, the flight status can be used to filter the aircraft on the ground in the system if necessary.

e) ACAS Resolution Advisory Report

The ATM automation system can collect the ACAS Resolution Advisory Report and the information can be shown in the system to improve situational awareness of the controller. On receipt of ACAS Resolution Advisory notification, a prominent notification is displayed in a field that may be acknowledged. The indication is removed when the ACAS RA is resolved.

Note: The display of ACAS Resolution Advisory Report in ATM automation system can be turn on or turn off by user, and it is not recommended by IFATCA. The user is suggested to do the relevant safety evaluation before applying this function.

7.4.2 Enhanced Surveillance

For the Enhanced Surveillance, the following parameters of aircraft can be beneficial to the ATM automation system:

a) Selected Altitude

- 1) The ATM automation system can collect the selected altitude of the aircraft and show the information to the controller to improve the situational awareness of the controller.
- 2) The ATM automation system can generate an optimized CLAM alert ~~SFL Mismatch Alarm~~ when the SFL chosen by the crew does not match the cleared altitude given by the

controller (CFL), alerting the controller to take appropriate action to remedy the issue. A SFL Mismatch Alarm shall be presented to the responsible controller as an indication in the coupled surveillance track label and in the associated flight strip.

- 3) The ATM automation system can also utilize the SFL to improve the accuracy of the safety net.

In MTCD function, the ATM automation system can use the selected altitude as the target climbing/descending altitude in the flight look-ahead time, and calculate the possibility of conflict with the predicted flight trajectories of other flights in the airspace through trajectory prediction. Calculations involving SFL could be more accurate, and improve the performance of MTCD.

In the MSAW function, the ATM automation system generally provides MSAW warning by using track data (heading and rate of climb/descent and mode c). The ATMs use of CFL or SFL can enhance the MSAW algorithms use of vertical data to predict MSAW alerts and reduce the number of false alerts.

b) ~~Barometric data~~ Barometric Pressure Setting

The ATM automation system can collect the barometric data of the aircraft and show the information to the controller. The system can provide a warning when the barometric data transmitted by the aircraft does not match the parameter of the area where the aircraft is operating.

c) Roll Angle, Track Angle Rate, True Track Angle, Ground Speed, Magnetic Heading, True Airspeed

- 1) The ATM automation system can collect these parameters and may allow the display of some of the information to the controller to improve the situational awareness of the controller. This information can be displayed in various ways (e.g., a DAP Window) as offline defined, according to the requirement of the controllers. Display of some parameters, provides a clearer picture to the controllers generating a reduction in radio calls with the pilot, so the R/T usage between the controller and individual aircraft under service are reduced.
- 2) The system can make use of DAPs kinematics parameters for consistency checking, and perform a more precise tracking function.
- 3) The system can utilize the kinematics information of the aircraft to perform a more precise tracking function and improve the accuracy of safety net functions, (e.g., Short-Term Conflict Alert (STCA)), through the provision of more accurate aircraft tracks.
- 4) The system may use True track angle, Magnetic Heading, True Airspeed and Ground Speed to calculate a wind direction and speed of a specific area, which will enable the updating of forecast winds and improve trajectory modeling in the system. The system may also show the wind information to the controller to improve the situational awareness of the controller.

d) ~~Vertical Rate~~ Barometric Altitude Rate, Inertial Vertical Velocity

The ATM automation system can collect the vertical rate data of the aircraft to improve the precision of the compute altitude and the accuracy of the related alert. The system can make use of the data to realize an optimized CFL protection in STCA and MSAW analysis function.

e) Indicated Air Speed/Mach Number

The ATM automation system can acquire indicated air speed/airspeed/Mach number of the aircraft, allow ATC to monitor the aircrew compliance with the controller's instructions, and if required provide a warning to the controller when there is a mismatch.

7.5 Flight Planning

7.5.1 ICAO Flight Plan Item 7 - Aircraft Identification

ACID must be accurately recorded in item 7 of the ICAO Flight Plan form as per the following instructions:

Aircraft Identification, not exceeding 7 alphanumeric characters and without hyphens or symbols is to be entered both in item 7 of the flight plan and replicated exactly when set in the aircraft (for transmission as Flight ID) as follows:

Either,

- a) The ICAO designator for the aircraft operating agency followed by the flight identification (e.g. KLM511, NGA213, JTR25), when in radiotelephony the call sign to be used by the aircraft will consist of the ICAO telephony designator for the operating agency followed by the flight identification (e.g. KLM 511, NIGERIA213, JESTER25).

Or,

- b) The nationality or common mark registration marking of the aircraft (e.g. EIAKO, 4XBCD, N2567GA), when:
 - 1) in radiotelephony the call sign used by the aircraft will consist of this identification alone (e.g. CGAJS), or preceded by the ICAO telephony designator for the operating agency (e.g. BLIZZARD CGAJS),
 - 2) the aircraft is not equipped with a radio.

Note 1: No zeros, hyphens, dashes or spaces are to be added when the Aircraft Identification consists of less than 7 characters.

Note 2: Appendix 2 to ICAO DOC4444 (PANS-ATM 16th edition, 2016) refers.

Note 3: Standards for nationality, common and registration marks to be used are contained in Annex 7, section 3.

Note 4: Provisions for the use of radiotelephony call signs are contained in Annex 10, Volume II, Chapter 5. ICAO designators and telephony designators for aircraft operating agencies are contained in Doc 8585 — Designators for Aircraft Operating Agencies, Aeronautical Authorities and Services.

7.5.2 Equipment (Surveillance Equipment /SSR Equipment)

- a) ICAO Flight Plan Item 10 – Surveillance Equipment and Capabilities

When an aircraft is equipped with a Mode S Transponder, appropriate Mode S designators shall be entered in item 10 of the flight plan to indicate that the flight is capable of transmitting Mode S DAPs messages.

These are defined in ICAO DOC 4444 as follows:

‘N’ No surveillance equipment for the route to be flown is carried, or the equipment is unserviceable

SSR Mode A and C

‘A’ Mode A transponder

‘C’ Mode A and Mode C transponder

SSR Mode S

‘E’ Mode S transponder, including aircraft identification, pressure-altitude and extended squitter (ADS-B) capability

‘H’ Mode S transponder, including aircraft identification, pressure-altitude and enhanced surveillance capability

‘I’ Mode S transponder, including aircraft identification, but no pressure-altitude capability

‘L’ Mode S transponder, including aircraft identification, pressure-altitude, extended squitter (ADS-B) and enhanced surveillance capability

‘P’ Mode S transponder, including pressure-altitude, but no aircraft identification capability

‘S’ Mode S transponder, including both pressure altitude and aircraft identification capability

‘X’ Mode S transponder with neither aircraft identification nor pressure-altitude capability

Note: Enhanced surveillance capability is the ability of the aircraft to down-link aircraft derived data via a Mode S transponder.

b) ICAO Flight Plan Item 18 – Other Information

Where required by the appropriate authority the ICAO AA (24 Bit Code) may be recorded in Item 18 of the ICAO flight plan, in hexadecimal format as per the following example:

CODE/7C432B

Members or states should note that use of hexadecimal code may be prone to human error and is less flexible in regard to airframe changes for a notified flight.

7.5.3 Inconsistency between Mode S Flight Planning and Surveillance Capability

Inconsistency between flight planning of Mode S and surveillance capability of an aircraft can impact on ATC planning and situational awareness. States are encouraged to monitor for consistency between flight plan indicators and actual surveillance capability. Where discrepancies are identified aircraft operators should be contacted and instructed to correct flight plans, or general advice (as appropriate to the operational environment and type of flight planning problems) should be issued to aircraft operators.

Advice to Operators:

Concerning inconsistency between Mode S Flight Planning and Surveillance Capability:

- a) ICAO AA (24 Bit Code) not submitted, or submitted incorrectly.
- b) Mode S and surveillance capabilities indicators incorrectly.

The flight planning requirements **and relevant designators** for aircraft are described in local document reference or ICAO DOC 4444 Appendix 2. The capability of the aircraft transponder and ADS-B capability will typically be available in the transponder manual or ~~in~~ the aircraft flight manual for the aircraft. If in doubt, consult the transponder manual, aircraft flight manual or the Licensed Aircraft Maintenance Engineer.

7.5.4 Setting Flight ID in Cockpits

a) Flight ID Principles

The Flight ID is the equivalent of the aircraft callsign and is used in both Mode S SSR and ADS-B technology. Up to seven characters long, it is usually set in airline aircraft by the flight crew via a cockpit interface. It enables air traffic controllers to identify an aircraft on a display and to correlate a radar or ADS-B track with the filed flight plan ACID. Flight ID is critical, so it must be entered carefully. Punching in the wrong characters can lead to ATC confusing one aircraft with another.

~~It is important that the Flight ID entered in the transponder exactly matches~~ **The Flight ID entered in the transponder exactly must match the** ACID entered in the flight plan.

Intuitive correlation between an aircraft's flight identification and radio callsign enhances situational awareness and communication. Airlines typically use a three letter ICAO airline code in flight plans, NOT the two letter IATA codes.

b) Setting Flight ID

The callsign dictates the applicable option below for setting Mode S or ADS-B Flight ID:

- 1) The flight number using the ICAO three-letter designator for the aircraft operator if a flight number callsign is being used (e.g. QFA1 for Qantas 1, THA54 for Thai 54).
- 2) The nationality and registration mark (without hyphen) of the aircraft if the callsign is the full version of the registration (e.g. VHABC for international operations).
- 3) The registration mark alone of the aircraft if the callsign is the abbreviated version of the registration (e.g. ABC for domestic operations).
- 4) The designator corresponding to a particular callsign approved by the ANSP or regulator (e.g. SPTR13 for firespotter 13).
- 5) The designator corresponding to a particular callsign in accordance with the operations manual of the relevant recreational aircraft administrative organization (e.g. G123 for Gyroplane 123).

7.6 Contingency Plan

ANSPs should prepare appropriate contingency plans in the event of a system failure that prevents **the** use of Mode S DAPs.

8. TRAINING AND COMPETENCE

8.1 Introduction

Training and development play an important role in the effectiveness of organizations and to the experiences of people in work. Training on DAPs has implications in improving productivity, aviation safety and personal development. The primary goal of the training is to develop and maintain an appropriate level of trust in DAPs related module, i.e. to make ATC and ATSEP aware of the likely situations where DAPs will be effective and, more importantly, situations in which DAPs will not be so effective (e.g. sudden, unexpected maneuvers).

8.2 Training of an Air Traffic Controller (ATC) in DAPs

With the inclusion of DAPs into surveillance and ATM automation system, an ATC training plan should adopt a modular approach. This approach progressively introduces various features, functionality of the new system on one hand and allows for integration with the ATC operational procedures. Additional benefits include shorter, logical self-contained units, clear attainable goals, better evaluation of training effectiveness and simplified self-assessment.

The ANSP should develop familiarization and rating focused training to ATC prior to adoption of DAPs in Surveillance and ATM automation systems.

The ANSP should ensure that all ATC concerned are assessed as competent for the use of the relevant DAPs module.

8.3 Training of an ATSEP in DAPs

- a) The ANSP should develop an ATSEP training programme that is acceptable to the ANS Regulator prior to its implementation.
- b) As a minimum, the training programme should comprise three levels as described below:
 - 1) Level 1 (Basic training). This should comprise training on the basic Surveillance and ATM automation systems operating in the State and their impacts on the safety of aircraft operations. The ANSP should ensure every ATSEP undergoes the basic training.
 - 2) Level 2 (Qualification training). This should comprise training to develop knowledge and skills on Surveillance and ATM automation systems. The ANSP should ensure each ATSEP is trained in one or more domains depending on their job scope.
 - 3) Level 3 (Specialized training). This should comprise training on specific Surveillance and ATM automation systems installed in the State, followed by on-the-job training.
- c) The ANSP should conduct a yearly review of the training plan for each ATSEP at the beginning of the year to identify any gaps in competency or changes in training requirements and priorities the type of training required for the coming year in regards of DAPs development.
- d) The ANSP should keep records of individual ATSEP training, competency assessment and approval history, where applicable, and associated documents. The records should be kept at least until the Surveillance and ATM automation system of which the ATSEP was trained on is no longer in use with the ANSP.
- e) The individual training records for each of ATSEP should include a training plan detailing the courses completed as well as the time-frame for attending future courses as required under

his/her training plan.

8.4 Competency Assessment of an ATSEP in DAPs

- a) The ANSP should develop an assessment methodology to determine the competency of an ATSEP in accordance with the competency framework developed in PANS-Training and which should be adapted to suit the local context.
- b) The ANSP may select a person to be a competency assessor only if the person –
 - 1) is an ATSEP approved in accordance with paragraph 8.3 for the particular Surveillance and ATM automation system; and
 - 2) has received adequate training in the conduct of competency assessment, practical checks and oral questionings.
- c) A competency assessor should not conduct a competency assessment on an ATSEP who is under the direct supervision of the competency assessor, unless the assessment is done in the presence of a second independent assessor.
- d) The assessment methodology should include a process for on-going competency checking and refresher training to ensure retention of competence.

9. SPECIFIC EXAMPLES ON MODE S DAPs APPLICATION

9.1 Use of Selected Altitude

Since August 2013, Mode S data processing functions have been implemented in Chengdu ATM automation system. The system uses the select altitude data extracted from the Mode S DAPs to provide an optimized CLAM alert for controllers. The system will generate the alert when the SFL chosen by the crew does not match the cleared altitude recorded in the ATM automation system. And a time delay parameter is predefined for the response time of the flight after controllers input to the ATM automation system (typically at the time of instruction given to the pilot).

Thanks to this new kind of alert, controllers have a better awareness of the intention of the airplanes and may discover the crew's mis-operation much earlier than the traditional CLAM, and then take actions timely to avoid the potential conflict.

In April 2017, an A320 aircraft was maintaining level flight at 27600 feet with another flight flying nearby at 26600 feet. Suddenly, the crew set an error altitude 22600 feet. The ATM automation system triggered the alert immediately even before the aircraft began to descend. The controller quickly noticed the alert and informed the crew in time. The aircraft successfully stopped descend at 27400 feet.

9.2 Use of ACAS RA

With the advancement of the ASTERIX standards and DAPs application, an ATM system can handle the derived data from Aircraft, which is detected, received and transmitted through the Mode S Radar, ADS-B station, and WAM sensors . In the event that an Airborne Collision Avoidance System (ACAS) Resolution Advisory (RA), the ATM system is able to provide a visual and aural alarm warning and indicative pilot intention to the controller.

Resolution Advisory (RA) alerting function works as follows:

- A resolution advisory is present when, in the subfields I048/260, I020/260, I021/260, I021/260 or I062/380 subfield #12(ACS), the bits are set as follows:

- the first bit of the ARA field set to 1 and the RAT bit set to 0 or,
- the first bit of the ARA field set to 0, the MTE bit set to 1 and the RAT bit set to 0.

- A resolution advisory is removed when:

- the ACAS RA report subfield (I048/260, I020/260, I021/260 or I062/380 subfield #12(ACS)) contains the RAT bit set to 1, or
- An ACAS RA report is not received in the relevant Data Item of the ASTERIX report.

Besides, the Resolution Advisory Intention is populated base on the PILOT selection and according to the following table:

MTE (60)	ARA (41)	42	43	44	45	46	47	RA Selection	RA Intention
1	0	Any	0	Any	1	Any	Any	Descend	Positive descend (Descent)

									to avoid the threat)
1	0	Any	1	Any	0	Any	Any	Climb	Positive climb (Climb to avoid the threat)
1	0	Any	0	Any	0	Any	Any	Other	Other (reduce rate of climb or descent, etc.)

*NOTE1: ACAS Airborne Collision Avoidance System, applied in the EURO Aviation System, has the same meaning as TCAS abbreviated to Traffic Alert and Collision Avoidance System in the USA Aviation System

*NOTE2: The function and the matters needing attention related to ACAS Resolution Advisory Report in ATM automation system, please refer to 7.4.1 e).

9.3 Use of Mode-S DAPs data for weather forecast

Meteorological Research Institute (MRI) and Electronic Navigation Research Institute (ENRI) conducted experiments for improving weather forecast accuracy utilizing Mode S DAPs data. In this research, estimate horizontal wind and temperature from the data in registers BDS code 5,0 and BDS code 6,0 which list below.

Table 9- DAPs information for weather forecast

Register	Name	Data Item
BDS code 5,0	Track and turn report	True Track Angle
		Ground Speed
		True Airspeed
BDS code 6,0	Heading and speed report	Magnetic Heading
		Mach Number

The temperature is the function of Mach number and True Airspeed. To estimate horizontal wind speed and direction, calculating zonal wind speed and meridional wind speed from ground speed, true airspeed, true track angle and true heading angle. The true heading angle is obtained from magnetic heading angle and magnetic declination(D2010) which is given by a quadratic equation. Then the wind and temperature as observation data were used to analyze and adjust the value of the numerical model to improve weather forecast accuracy.

The results of the experiments indicate that Mode S DAPs data have the potential to improve forecasts of rainfalls and shear-lines. For details, please refer to the IP11 presented by Japan at the Mode S DAPs/3.

9.4 Use of Barometric Pressure Setting

When the aircraft is below the transition level the pilot is required to set barometric pressure setting in altimeter to local QNH/QFE. Wrong barometric pressure setting (especially QNH higher than actual) can lead to cleared flight level deviation or more serious controlled flight into terrain, as the pilot sees higher altitude on his altimeter and the flight management system determines the lower target altitude base on barometric pressure setting and selected altitude. Every millibar of barometric pressure setting error may add 30 feet of error to altimeter and target altitude.

Constantly checking if the barometric pressure setting in DAPs is consistent with the airport's QNH can alert the controller to avoid similar situations. In Feb 2021, an aircraft was cleared to descend to 7000 feet. The pilot set the right selected altitude, but forgot to set barometric pressure setting. At that time, the airport QNH was 1013, while the crew barometric pressure setting was 1118.5. An alarm system notified the controller of this situation. The error was corrected after the controller prompted the pilot preventing a dangerous situation.

Left to blank

APPENDIX 1: Mode S DAPs Analysis

a) Data Recording Configuration

Figure 1 represents an example of a configuration for data recording. The Mode S sensor sends interrogations to an individual aircraft using a unique ICAO 24-bit aircraft address. The Mode S transponder has 255 BDS Registers. Each register stores aircraft parameters data derived from FMS or other sensors. An interrogation uses GICB protocol to request a specific BDS Register data. In response to the interrogation, Mode S transponder sends a reply which contains the BDS register data.

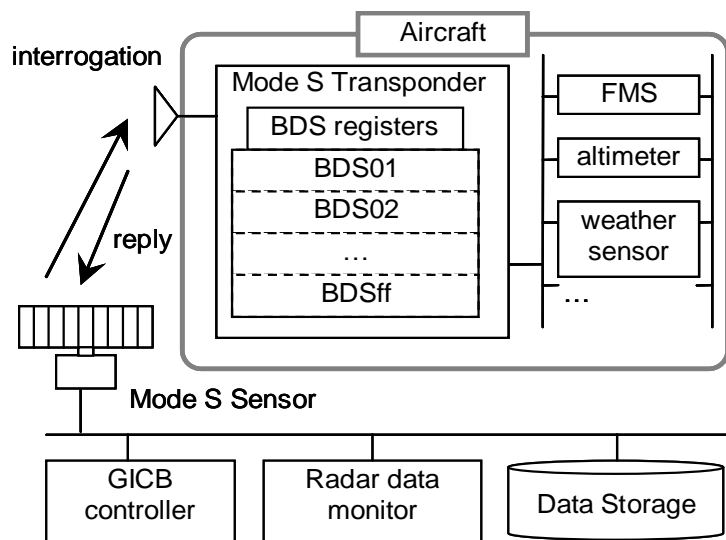

Figure1 - Example of Data Recording Configuration

b) Data Analysis

As described above section, erroneous DAPs data have been observed due to failure or improper setting/installation of Mode S avionics equipment. Bad data hinders the use of DAPs by the ATM service. To employ DAPs for ATM services, the reliability of DAPs is important. Therefore, it is necessary to analyze the recorded data to ensure reliability of the DAPs data.

If a controller finds some problem during the application of the Mode S DAPs, the ATS providers can analyze the recorded data to find the exact reason which caused the problem. If the ATS equipment has a fault which caused the problem, the ATS provider should implement a solution as soon as possible. If the ATS provider proves that the problem is caused by an avionics fault, then the problem should be reported to the appropriate party to solve the problem. The ATS providers need to devise mechanisms and procedures to address identified faults.

ATS providers should develop systems to analyze the routine recorded data. From the analyses, ATS providers can provide more information of the transponder's performance such as SI capability, datalink capability etc. The information can be used to improve the capability of the operation of Mode S DAPs equipment. By analyzing the recorded data, advice on avionics anomalies and faults, which have been detected, can be passed onto the regulators and the aircraft operators.

c) DAPs Data Validation

To ensure that Mode S DAPs are operating in conformance with the ICAO requirements, validating DAPs data is highly recommended. It has been noted that there are some drawbacks in the traditional methodology of executing tests for aircraft on the ground as follows:

- 1) Avionics for DAPs consist of several devices and functional blocks. They are interconnected, and the configuration is complicated.
- 2) Avionics and configuration differ depending on each aircraft.
- 3) It is difficult to cover the possible test patterns completely.
- 4) Ground test methodology would not detect failures or anomalies that occur after the testing.

Responding to these drawbacks, MIT Lincoln Laboratory developed and proposed a DAPs validation methodology, which monitors DAPs data received from actual flying aircraft to detect erroneous data. The MIT validation methodology is mainly categorized by two groups, static value tests and dynamic value tests.

Static value tests are executed to detect erroneous values of the bits and fields in BDS registers which do not change during a flight. Those bits and fields represent the avionics system's configuration, capability, and status information. These tests verify that those bits and fields are proper values in compliance with the ICAO regulations for DAPs applications. Table 1 shows an example of static value tests. As can be seen by the table, failed data were detected in each BDS register test. For BDS Register 20₁₆, failed data with wrong character coding were caused not due to equipment problem, but to faulty data input.

Table 1 Example of Static Value Tests

BDS Register	Test Item	Total Count		Aircraft	
		Executed	Failed	Executed	Failed
BDS code 1,0	Aircraft identification capability flag = '1'	544,980	7,183	3,615	146
BDS code 2,0	Each character conforms to ICAO 6-bit character coding	737,993	1,516	3,596	144
BDS code 4,0	Unavailable data fields are set at zero	54,248,802	1,755	3,614	4

Dynamic value tests validate the values which dynamically change according to aircraft motion, such as aircraft speed and track angle. The tests compare the DAPs values with equivalent data like radar-measured positions. If the difference between DAPs values and radar-derived parameters exceeds the acceptability threshold, the DAPs value is accounted as an error. Figure 2 represents an example of dynamic value tests. This figure indicates that ground speed differences between DAPs data and radar-derived data fall inside the threshold range.

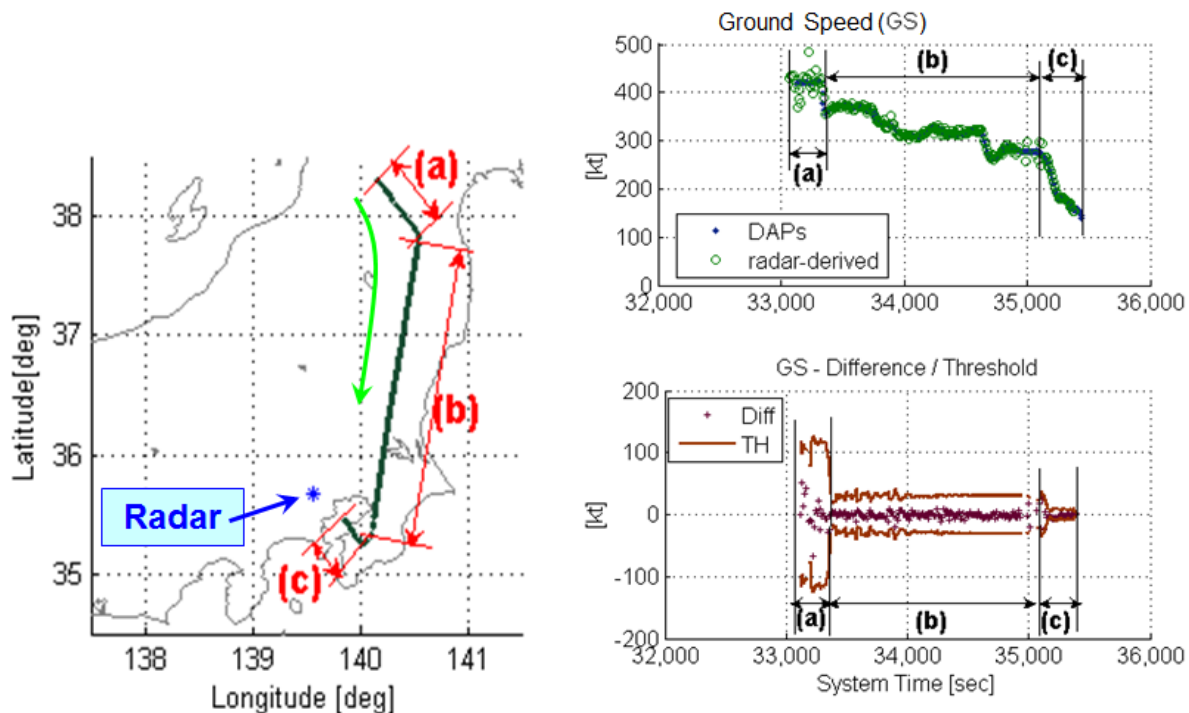

Figure 2 - Example of Dynamic Value Tests

left to blank

APPENDIX 2: LIST OF IDENTIFIED ISSUES

Ref.	Issue	Cause	Safety Implications to ATC (Yes / No)	Recommendations
1.	Wrong ground bits in DAPs led to the track decoupling from the flight plan	Through joint investigation with the airlines, it found that parts of the aircraft A were exchanged with another aircraft B for test. The malfunction part was discovered when the wrong ground bits data was found coming from the aircraft B.	Yes The wrong ground bits in DAPs could make ATM automation system display track decoupled with flight plan	
2.	Wrong aircraft identification	Many cases of wrong aircraft identification were found at the beginning of mode S operation. All related data collected and sent to the relevant airlines by the management department. Through joint investigation with the airlines, it was found that the issue is normally due to pilot's error.	Yes Wrong aircraft identification could lead to wrong flight plan coupling.	Through the joint efforts of ATMB and the airlines, the aircraft identification data became more and more accurate.
3.	Wrong Barometric Pressure	Barometric Pressure, such as BARO or QNH, is available in Mode S BDS code 4,0. Initial testing found that data above the transition level for some aircraft types would not be useful due to a mismatch between what the crew set in the cockpit, and what the aircraft Downlinked.	Yes There will display a wrong Barometric Pressure with aircraft in ATM automation system.	EASA Safety Information Bulletin SIB-2016-05R2 (“Incorrect Downlink Barometric Pressure Settings”) covers this issue.
4.	Different processing between Mode A/C and Mode S Altitude	Currently, the altitude accuracy of Mode A/C radar is 100ft, while that of Mode S radar is 25ft. The altitude tracking, and display mechanism of ATM automation systems could be received both precisions altitude data.	Yes In Mode S radar and Mode, A/C radar overlapped area, the ATM automation systems might display an altitude jumping.	The altitude tracking, and display mechanism of ATM automation systems need to be optimized to avoid altitude jumping.

5.	Mode S interrogators request the aircraft transponder registers too frequently in busy airspace	If Mode S interrogators request the aircraft transponder registers too frequently in busy airspace, it may appear that the transponder registers information cannot complete the whole transmission process. The BDS parameters requesting rule needs to be set by the Mode S interrogator reasonably.	Yes ATM automation system would display track delay or intermittent interruption of radar data.	The data transmission rate of Mode S radar to feed ATM automation system needs to be selected reasonably to meet the requirements of ATC operations in busy airspace to prevent track delay or intermittent interruption of radar data.
6.	Mode S DAPs data does not correspond to the content of the requested register	<p>It has been noted that from time to time Mode S DAPs data does not correspond to the content of the requested register. For example, the content of BDS code 5,0 is received when extracting BDS code 4,0. This phenomenon is called “BDS swap”.</p> <p>Table 1 represents an example data of BDS swap. The table shows the data of BDS code 0,5/4,0/5,0 data downlink from an aircraft in three sequential scans. As can be seen by the table, BDS swap occurred at 08:05:45.</p>	Yes Wrong information could display to controller.	<p>Different options can be implemented to decrease the impact of such as:</p> <ol style="list-style-type: none"> 1. limit the number of radars extracting aircraft registers 2. implement specific filters in radar or in the surveillance data processing to discard the erroneous data (e.g. when two different registers are received with the same content they are both discarded)

7.	Duplicated aircraft address	<p>One case was related to a local airline, wrong spare parts of the airplane were installed by mistake during maintenance. The airline replaced the spare parts after being informed. Another case was military aircraft.</p> <p>Another reason has been observed that in many cases the 24-bit aircraft address transmitted by the aircraft does not match its nationality (i.e. its State of Registry's block) or is otherwise incorrectly configured in the transponder. Care needs to be taken to ensure that the registration and the 24-bit address of every aircraft are processed and assigned simultaneously by the regulatory authority, and reporting mechanisms are in place to rectify incorrect configurations.</p>	<p>Yes</p> <p>The possible consequences are as follows:</p> <ol style="list-style-type: none"> 1. An aircraft may be locked out in error, if it is the same beam. This may result in a new aircraft not being detected when it enters Mode S radar coverage. 2. Possible track label swap for crossing aircraft, this may result in incorrect labeling of an aircraft on the Radar screen. 3. In the technical operation of Mode S Elementary surveillance, duplicated address may result in the possible loss of a track when the two aircraft are crossing due to the interrogation scheduling within the ground station. 	<p>According to Annex 10, the aviation authority of each State is responsible for assigning 24-bit addresses to all aircraft in its registry using the block allocated by ICAO to that State.</p> <p>The duplicate address should be detected and reported.</p> <p>Without duplicate address detection, if an aircraft enters the range of the Mode S SSR with the same ICAO 24-bit address as that of an existing target, the information of the new aircraft could be erroneously associated with the existing target.</p> <p>Once the Mode S DAPs System detect more than one aircraft is transmitting the same ICAO 24-address, it will initiate a duplicate address report and a duplicate address condition shall be declared, and when receive new information of this address, the system should associate the information by ID or position but not the address.</p>
8.	incorrect aircraft address in flight plan	<p>Although the overwhelming majority aircrafts are equipped with Mode S transponders, many flight plans are not filed with the correct aircraft address in</p>	<p>Yes</p> <p>This affects the function of aircraft address correlation in ATM automation system.</p>	

		item 18.		
9.	incorrect wind speed and direction	Aircrew round the system output figures from Spot Wind data was the main reason for variations by crew response. e.g. Recorded wind 283/42kts, crew response 280/40kts.	No	
10.	empty ACAS RA message	ASTERIX message “I048/260, ACAS Resolution Advisory Report” indicates that airplane is in ACAS RA condition. In some cases, all zero I048/260 reports are received in the ATM automation system through Mode S radar.	Yes ATM automation system may generate false ACAS alarm from Empty RA message.	ACAS message handling feature at ATM system must be checked on at its installation stage following the ACAS message flow
11.	erroneous SFL information	It is noticed ATM automation system could receive erroneous SFL information due to the BDS swap problem and other reasons.	Yes ATM automation system may generate false SFL mismatch alarm due to the erroneous SFL information.	ATM automation system could use multiple data sources to check the SFL data.
12.	Incorrect ACAS RA information	Many cases of incorrect ACAS RA information were found at the Mode S operation. After analysis the incorrect ACAS RA data, the reason is so called “BDS Swap” and only the old type of Mode S radar has the “BDS Swap” problem.	Yes Wrong information could display to controller.	Short term solution: Reject data (BDS content and/or reply) in case of difference between UF and DF. Reject BDS content (BDS 1,0; 2,0 and 3,0) in case of first byte error. Medium /long term solution: "Overlay" function is introduced in the fifth edition of Volume IV of ICAO document annex 10. the DP (data parity) field is designed to replace the AP field to check

				the BDS register number in the downlink DF20 / 21. It aims to solve BDS swap problem from the source.
--	--	--	--	---

Table 1 Example Data of BDS Swap

BDS Register	Time of Scan		
	08:05:35	08:05:45 (BDS swap occurred)	08:05:55
BDS code 0,5	605f80c056966f	a3280030a40000	605f845303ce8d
BDS code 4,0	a3280030a40000	a3280030a40000	a3280030a40000
BDS code 5,0	fff8cf1f800489	a3280030a40000	ffb8cf1f80048a

left to blank

APPENDIX 3: LIST OF PARTICIPANTS

Name	States/Administration	Name	States/Administration
Luo Yi	ICAO	Xie Yulan	China
Cao Susu	China	Guo Jianhua	China
Jin Lijie	China	Duan Bo	China
Zhang Kai	China	Wang Xiaowei	China
Chen Yang	China	Wang Yu	China
Zhou Shuiping	China	Tang Weisheng	China
Yao Yuan	China	Michael MH Chu	Hong Kong, China

Charles Leung Charn Wai	Hong Kong, China	Hiromi Miyazaki	Japan
Yasuhiro Otani	Japan	Ho Wee Sin	Singapore
Mei Chin NG	Singapore	Chin Lin KWEK	Singapore
Meng Soon KHOO	Singapore	Khairul Nazmi Bin Zainol Ariffin	Malaysia
Mohd Shahrul Azree Bin Remly	Malaysia	Shairyzal B. Mohammad C. Azizan	Malaysia
Alford Andy	New Zealand	Milns Alex	Australia

~~Left to blank~~

APPENDIX 43: A Brief Introduction of Mode S DAPs Data Source

1. Introduction

1.1 During the 2nd meeting of ICAO APAC Mode S DAPs WG, China presented an information paper regarding the Mode S DAPs data source, the meeting was of the view that the content of the paper will help in the understanding of the basic mechanism of avionics relevant to surveillance application and implementation of DAPs.

-Refer to Mode S DAPs WG/2 IP05 “Preliminary Study of DAPs Data Sources”

1.2 The Mode S DAPs provides useful information on aircraft that will enhance ATM operations. More attention should be paid when introducing Mode S DAPs and it's important to clearly understand what these parameters are and where these parameters come from. This text provides give some brief information about the parameters.

2. Mode S DAPs ELS and EHS

2.1 Mode S DAPs-based surveillance includes ELS (Elementary Surveillance) and EHS (Enhanced Surveillance).

2.2 Most of the ELS parameters are capability parameters of the aircraft, hence are static. They can be used for improved aircraft identification, and have less direct impact on ATC operations. The ELS parameters are shown in Table 2.1.

Table 2.1 ELS Parameters Information

Register	DAP Set	Bits	Units	Quantity	Range
ELS	24-Bit Aircraft Address (AA)	NA	NA	NA	NA
	Transponder Capability (CA)	NA	NA	NA	NA
	Flight Status (FS)	NA	NA	NA	NA
	Altitude Reporting in 25ft	NA	ft	25	[-1000, 50175]
	BDS 1,0 Datalink Capability Report	56	NA	NA	NA
	BDS 1,7 Common GICB Capability Report	56	NA	NA	NA
	BDS 2,0 Aircraft Identification Report	56	NA	NA	NA
BDS 3,0 ACAS Resolution Advisory Report	9-22	NA	NA	NA	NA

2.3 EHS parameters are more related to the aircraft's intention and status, and most of them are dynamic. The implementation of EHS parameters has a larger impact on controllers. The EHS parameters are shown in Table 2.2.

Table 2.2 EHS Parameters Information

Register	DAP Set	Bits	Units	Quantity	Range
EHS	Selected Altitude (MCP/FCU)	2-13	ft	16	[0, 65520]
	Selected Altitude (FMS)	15-26	ft	16	[0, 65520]
	Barometric Pressure Setting	28-39	mb	0.1	[0, 410]
	BDS 5,0 Roll Angle	3-11	dg	45/256	[-90, +90]

	True Track Angle	14-23	dg	90/512	[-180, +180]
	Ground Speed	25-34	kt	2	[0, 2046]
	Track Angle Rate	37-45	dg/s	8/256	[-16, +16]
	True Airspeed	47-56	kt	2	[0, 2046]
	Magnetic Heading	3-12	dg	90/512	[-180, +180]
	Indicated Airspeed	14-23	kt	1	[0, 1023]
BDS 6,0	Mach No	25-34	NA	2.048/512	[0, 4.092]
	Barometric Altitude Rate	37-45	ft/min	32	[-16384, +16352]
	Inertial Vertical Velocity	48-56	ft/min	32	[-16384, +16352]

3. Mode S DAPs Data System

3.1 The ELS and EHS parameters originate from various sensors and cockpit settings. After being organized by the avionics systems, the information is being sent to the transponder through standard aircraft data buses, and subsequently formatted by the transponder and stored inside the relevant Binary Data Storages (BDS). The ground-based surveillance system could downlink desired DAPs by specific Mode S GICB (Ground Initiated Comm-B) protocol.

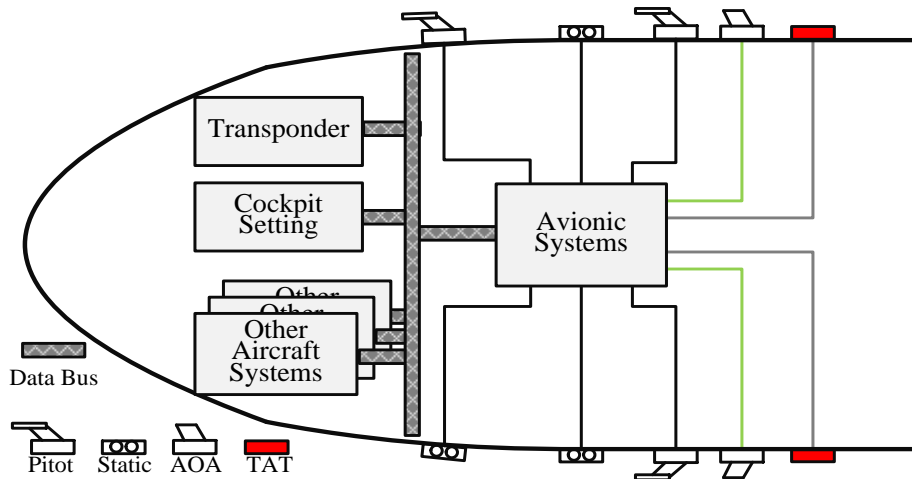

Figure 3.1 Typical DAPs Data Source Block Diagram

Transponder and TCAS Computer

3.2 The most common standard of the civil aircraft transponder, the Mark 4 Air Traffic Control Transponder, is based on the ARINC 718A standard. There are 3 main interface plugs defined on the rear panel, namely TP (Top Plug), MP (Middle Plug), and BP (Bottom Plug).

3.3 The airborne collision avoidance system, Traffic Computer TCAS and ADS-B Functionality, is based on the ARINC 735B standard. There are 6 main interface plugs defined on the rear panel, namely LTP (Left Top Plug), LMP (Left Middle Plug), LBP (Left Bottom Plug), RTP (Right Top Plug), RMP (Right Middle Plug) and RBP (Right Bottom Plug).



Figure 3.4 TT31 Mode S Transponder from TRIG

3.7 The Flight Status (FS) is a result of combination of the on-the-ground status, SPI, and Alert. The on-the-ground is the same as in 3.6, the SPI is from pushing IDENT function button of the transponder by pilot, and the Alert is produced by changing Mode A code (If changed to 7500, 7600, 7700, that's permanent alert; and if changed to other codes, that's 18 seconds temporary alert).

3.8 The Common Usage GICB Capability Report is generated by the transponder itself by detecting the corresponding input data availability, and then set the corresponding bit related to that GICB register.

3.9 The main source of Aircraft Identification is from FMS, input by pilot through Flight ID (or Flight No) menu, and the related data transmitted to transponder by specific data bus (ARINC 429 Labels 233~237). If the Flight ID is empty, then the Aircraft Registration data may be provided within another data bus (ARINC 429 Labels 301-303).

3.10 According to TCAS standard (ARINC 735B Chapter 3.3.4.1), the Datalink Capability Report and the Resolution Advisories Report are sent to the Transponder from TCAS Computer by specific protocol (TGD-TCAS to Transponder data transfer protocol, and Transponder to TCAS data transfer protocol is named XGD. The data bus used is ARINC 429 Label 270). The data are sent from RMP of the TCAS Computer to TP of the Transponder, related pins refer to Figure 3.5.

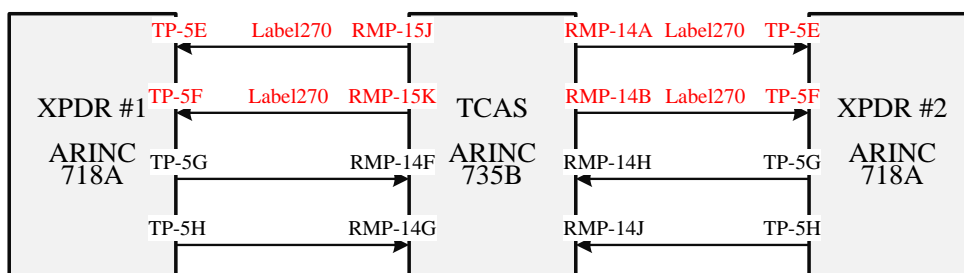

Figure 3.5 Illustrations of Datalink Capability and RA Report Transfer

3.11 There are 2 kinds of Selected Altitude, one is from MCP/FCU (Boeing's Mode Control Panel and Airbus's Flight Control Unit), and the other is from FMS (Flight Management System). The first one is set by the pilot in response to a controller's instruction during the flight, the second one is calculated by the FMS automatically to achieve the best cost-efficient.



Figure 3.6 MCP of Boeing B787 & FCU of Airbus A380

3.12 The Barometric Pressure Setting (BPS) is also located in the MCP/FCU, and set by the pilot rotating the knob to the pressure value comes from the aerodrome's ATIS (Automatic Terminal Information System).

3.13 The other parameters mainly come from the sensors onboard the aircraft, the sensors are organized in 3 groups, the air data sensors, the inertial sensors and the magnetic sensor.

3.14 The air data sensors are used to sense the medium through which the aircraft is flying, including pitot (static) probe, static port, temperature sensor, angle of attack sensor. Typical sensed parameters are total pressure (Pt), static pressure (Ps), pressure changing rate, air temperature (TAT), and angle of attack. Derived data includes Barometric Altitude (ALT), Indicated Airspeed (IAS), Vertical Speed (VS), Mach (M), Static Air Temperature (SAT), Total Air Temperature (TAT), True Airspeed (TAS) and Angle of Attack (AOA). The simplest system provides ALT and IAS.



Figure 3.7 Air Data Sensors and Integrated Sensor on Airbus A380

3.15 The inertial sensors are used to detect the motion of the aircraft in a universal reference system, including position gyroscopes, rate gyroscopes and accelerometers. By detection of the 3D dynamic of the aircraft, derived data includes Ground Speed (GS), Wind Speed, Wind Direction, True Track Angle, Roll Angle, and Track Angle Rate and so on.

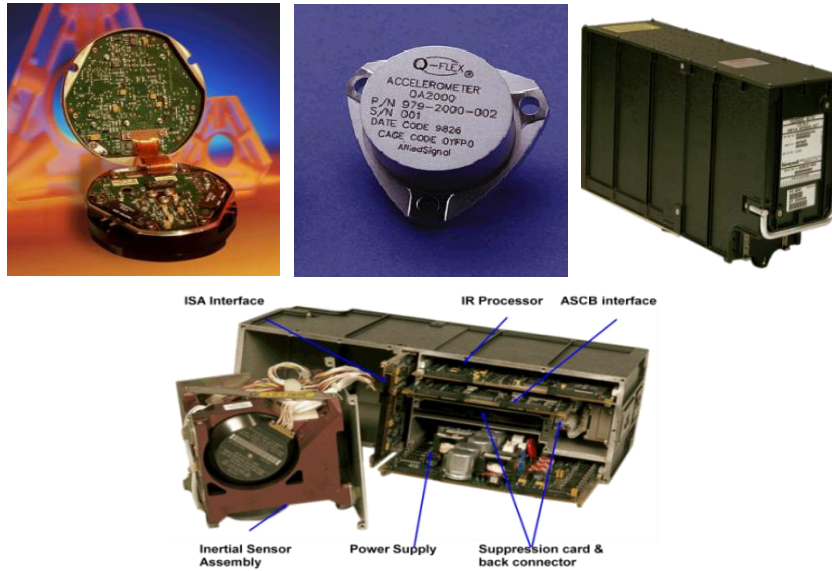

Figure 3.8 Gyro, Accelerometer and LASEREF IV IRU from Honeywell

3.16 The magnetic sensor is used to sense the direction and to find the magnetic north, and give out the main parameter of Magnetic Heading. The world magnetic model is show below:

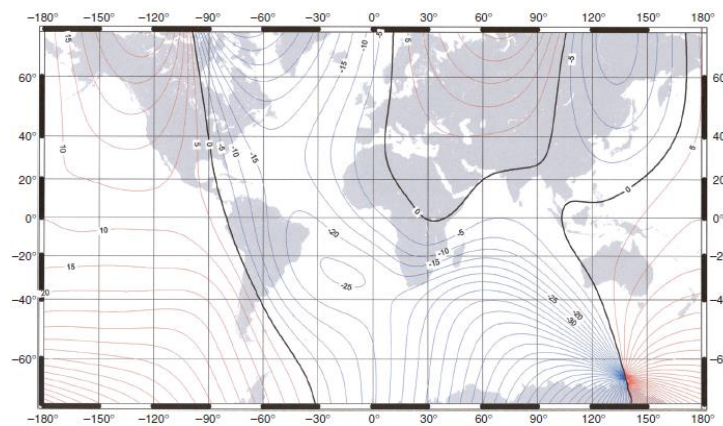

Figure 3.9 World Magnetic Model 2000

3.17 Some airplane platform uses an integrated solution to process these data, each air data sensor is connected with an Air Data Module (ADM) which converts the analog data to digital data and make the compensation of the instrumental and positional error. These data then feed to the input of Air Data Inertial Reference Systems (ADIRS) to calculate all the parameters mentioned before. And after that the parameters are sent to transponder and other avionics systems by the Data Bus.

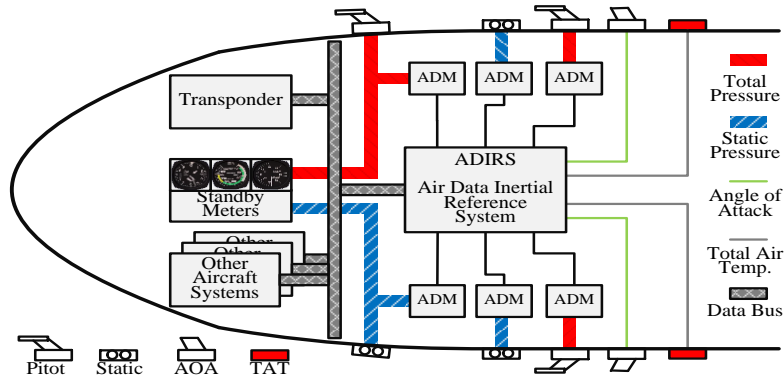

Figure 3.10 Typical ADIRS Architecture

3.18 The most commonly used data bus for parameters from ADIRS is ARINC 429 (and the newest evolution is AFDX invented by Airbus and implemented in various new aircrafts like A380 and B787), and the standard ARINC 429 Labels used by these parameters are as follows:

Table 3.1 ADIRS Parameters Used Labels of ARINC 429

No	DAP Item	Label
1	Mach No.	205
2	Indicated Air Speed	206
3	True Air Speed	210
4	Barometric Altitude Rate	212
5	Ground Speed	312
6	True Track Angle	313
7	Magnetic Heading	320
8	Roll Angle	325
9	Track Angle Rate	335*
10	Inertial Vertical Velocity	365

*Note: This label in GAMA configuration is not used for Track Angle Rate

3.19 By using these parameters, the aircraft dynamic is illustrated as in Figure 3.11.

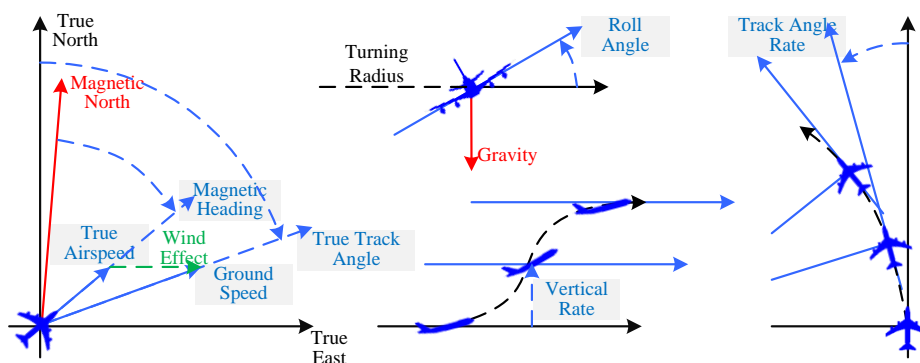

Figure 3.11 Illustration of Aircraft Dynamic

left to blank

APPENDIX 4: Mode S Parameter Set

Radar Coverage R

1.1 The Mode S radar coverage is defined as the farthest target the radar will process. If the Mode S radar uses a lockout map, the difference of the two coverage ranges should be noticed.

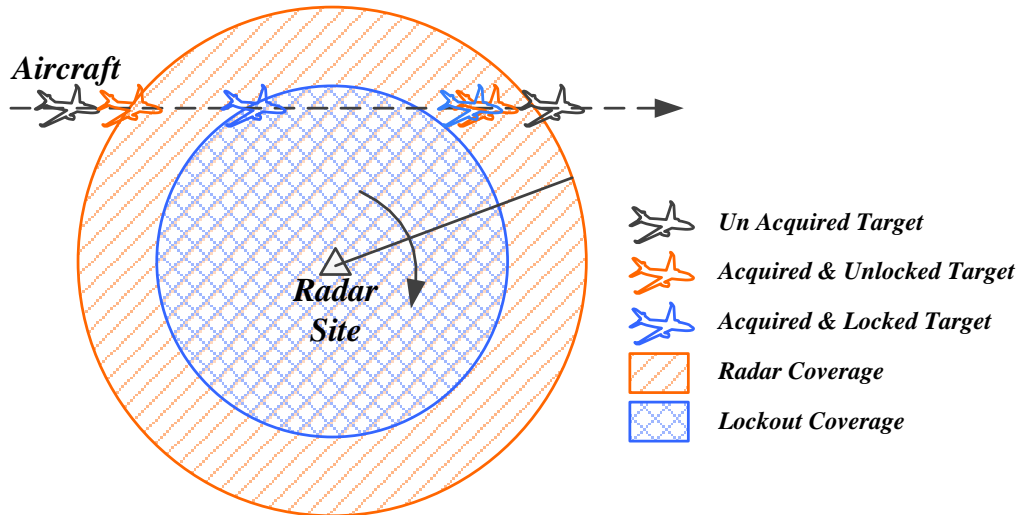

1.2 The radar coverage will decide the minimal All-Call period, this is to say, the time of All-Call period should:

$$T \geq \frac{R * 2 * 1852}{3 * 10^8}$$

Antenna Period Ta

2.1 The antenna period is the time of a successful antenna rotation, this time actually has very important influence of the total time resource of the radar. Lower antenna rotation speed will provide rich antenna period, hence time resource of the radar. The most commonly used antenna period is 4000ms (15rpm) and 6000ms (10rpm) for terminal surveillance radar.

Antenna Beamwidth B

3.1 Most of the secondary surveillance radar uses the same LVA antenna, the beam is more or less the same, and the standard interrogation beam has a -3dB width of $2.45^\circ \pm 0.25^\circ$. In Mode S interrogation, the suppression requirement actually allow to use a wider beam width than -3dB width, most of the radar choose 3.8° or roughly the -10dB beam width.

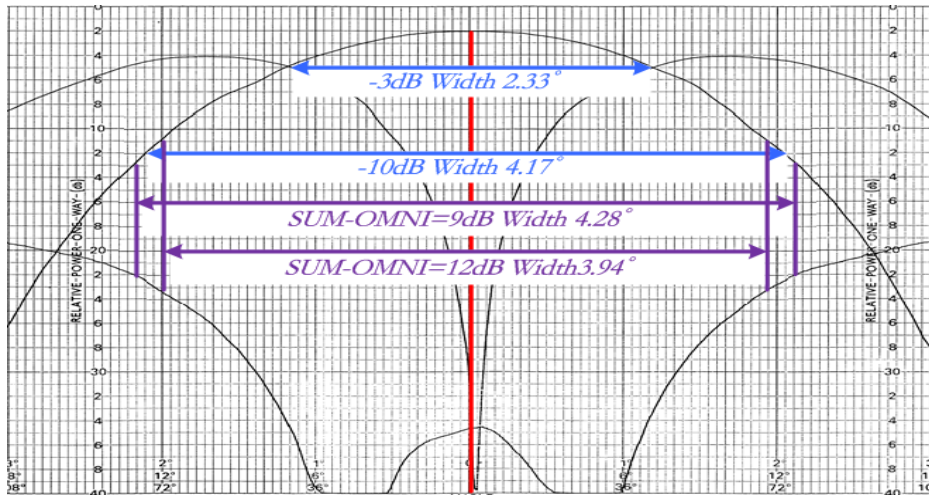

Time on Target T_t

4.1 The time on target is the total time amount the radar beam covers the target during one scan, it defines the time resource upper limit for one dedicated target, it is determined by both the antenna period and the beamwidth, and the relation is as follows:

$$T_t = \frac{T_a}{360} * B$$

4.2 It should be noticed that during a mix air operation (Conventional targets and Mode S targets flying in the same area in the same time), there is a need for the Necessary Transaction. That is during an antenna scan, there should be at least 4 transactions between the radar and the conventional target, in order not to miss conventional target.

All-Call Period T_{ac} and Roll-Call Period T_{rc}

5.1 The All-Call period and Roll-Call period setting are different radar by radar, but there should be some principles:

- 1) All-Call period should long enough to allow the coverage requirement;
- 2) During the time on target, the Necessary Transaction should be guaranteed;
- 3) Time resource should allocate to Roll-Call as much as possible; and
- 4) Algorithm should be used to optimize the scheduling in the Roll-Call period.

Mode Interlace Pattern MIP

6.1 Mode Interlace Pattern defines the radar operating mode setting. The setting is related to the specific radar environment, hence there is no standard MIP.

6.2 All the modes Mode S radar can use is listed in the following table:

No.	Mode	Description	Pulse Used
1	A	Mode A interrogation	8μs between P1 and P3
2	C	Mode C interrogation	21μs between P1 and P3
3	A _S	Mode A Only All-Call	8μs between P1 and P3, and short P4
4	C _S	Mode C Only All-Call	21μs between P1 and P3, and short P4
5	S _L	Mode ACS All-Call	8μs, 21μs between P1 and P3, and Long P4
6	S _{PO}	Mode S Only All-Call P for PR,O for LO	2μs between P1 and P2, and P6 UF11 inside P6
7	R	Mode S Roll-Call	2μs between P1 and P2, and P6 UF0/4/5/16/20/21 inside P6

6.3 For a specific MIP, the describe phraseology defines as follows, and also one example is listed below:

Mode[Time]/ Mode[Time]/ Mode[Time]/.....

Note: The All-Call and Roll-Call periods are separated by “/”, the “Mode” is one of the Modes listed above, and the “[Time]” stands for the duration of the periods.

6.4 An example is show as follows:

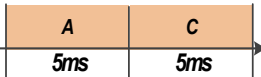
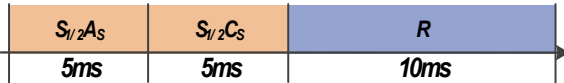
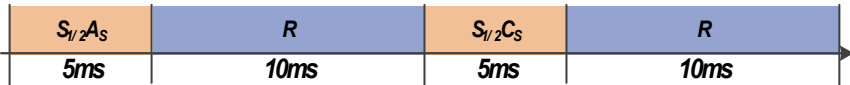
No.	Mode	MIP
1	Conventional	<p>A[5.0]/C[5.0]</p>  <p>Mode A and Mode C repeat, both duration are 5ms</p>
2	Mode S #1	<p>S_{1/2}A_S[5.0]/S_{1/2}C_S[5.0]/R[10.0]</p>  <p>2All-Call periods and 1 Roll-Call period repeat, All-Call duration is 5ms, Roll-Call duration is 10ms In the first All-Call, the PR=1/2, and use Mode A with short P4 In the second All-Call, the PR=1/2, and use Mode C with short P4</p>
3	Mode S #2	<p>S_{1/2}A_S[5.0]/R[10.0]/S_{1/2}C_S[5.0]/R[10.0]</p>  <p>1All-Call,1Roll-Call,1All-Call,1Roll-Call repeat, All-Call duration is 5ms, Roll-Call duration is 10ms In the first All-Call, the PR=1/2, and use Mode A with short P4 In the second All-Call, the PR=1/2, and use Mode C with short P4</p>

*Interrogation Repetition Frequency **IRF***

7.1 The Mode S introduced the Roll-Call period, which makes the interrogation repetition frequency a little bit different from the Conventional Mode. There is a need to define the interrogation repetition frequency by Mode IRF_{Mode}. Normally use IRF stands for the IRF_{AC} of Conventional mode and IRF_S of the Mode S All-Call. One example is listed below:

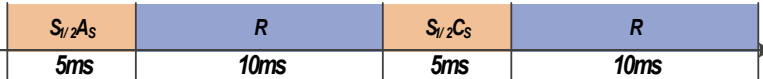
No.	MIP	IRF
1	A[5.0]/C[5.0] 	IRF _A =100Hz IRF _C =100Hz IRF _{AC} =200Hz
2	S _{1/2} A _s [5.0]/R[10.0]/S _{1/2} C _s [5.0]/R[10.0] 	IRF _A =38.5Hz IRF _C =38.5Hz IRF _{AC} =76.9Hz IRF _S =76.9Hz IRF _R =76.9Hz

DAPs Extraction Strategy

8.1 The DAPs extraction strategy normally includes the BDS number, extraction priority, extraction period, and re-extraction.

1) BDS number stands for the setting of the number of BDSs which radar is going to extract. It doesn't include the ELS registers, these registers should not be extract periodically;

2) Extraction priority stands for the priority of each BDS when the radar is performing extraction, the priority should be in accordance to the user's needs;

3) Extraction period stands for the period of the dedicated BDS extraction, normally described by the antenna scan number;

4) Re-extraction stands for the function of re-extraction of the dedicated BDS in the same beam dwell when the extraction is failed, but it's not recommend to re-extraction of more than 2 times.

Mode S Parameter Set Example

9.1 The following is an example of the Mode S Parameter Set:

No.	Parameter	Unit	Value	Note
1	R Coverage Range	NM	200	Equivalent All-Call Time $\frac{200 * 2 * 1852}{3 * 10^8} * 10^3 \approx 2.47ms$
2	Ta Antenna Period	ms	3800	Antenna Rotation Period
3	B Work Beamwidth	°	3.8	Mode S Work Beamwidth Normally Greater Than -3dB width of 2.45°
4	Tt Time on Target	ms	40.1	The Time on Target In One Scan $\frac{3.8}{360} * 3800 \approx 40.1ms$
5	Tac	ms	3.0	Equivalent Coverage Range

	All-Call Period			$\frac{3 * 10^8 * 3.0 * 10^{-3}}{1852 * 2} \approx 243\text{NM}$
6	Trc Roll-Call Period	ms	7.0	This Period Related To The Extraction Efficiency
7	MIP	—	—	$S_{1/2}A_s[3.0]/R[7.0]/S_{1/2}C_s[3.0]/R[7.0]$
8	IRF _{AC}	Hz	100	Interrogation Repetition Frequency of Mode S All-Call
9	DAPs Extraction	—	—	No. of BDS: 3 (BDS 4,0 5,0 6,0) Extra. Priority: BDS 4,0 6,0 5,0 Extra. Period: 1 Scan Re-Extraction: Yes