

CNS SG/22
Appendix K to the Report



**INTERNATIONAL CIVIL AVIATION ORGANIZATION
ASIA AND PACIFIC OFFICE**

**ADS-B IMPLEMENTATION AND
OPERATIONS GUIDANCE DOCUMENT**

Edition 11.0 - July 2018

Intentionally left blank

TABLE OF CONTENTS

1. INTRODUCTION 6

1.1 Arrangement of the AIGD 7

1.2 Document History and Management 7

1.3 Copies 7

1.4 Changes to the AIGD..... 7

1.5 Editing conventions 7

1.6 AIGD Request for Change Form 8

1.7 Amendment Record 9

2. ACRONYM LIST & GLOSSARY OF TERMS..... 11

2.1 Acronym List 11

2.2 Glossary of Terms..... 12

3. REFERENCE DOCUMENTS..... 13

4. ADS-B DATA 14

5. ADS-B IMPLEMENTATION 15

5.1 Introduction..... 15

5.1.1 Planning 15

5.1.2 Implementation team to ensure international coordination 15

5.1.3 System compatibility 15

5.1.4 Integration..... 16

5.1.5 Coverage Predictions 20

5.2 Implementation checklist..... 20

5.2.1 Introduction..... 20

5.2.2 Activity Sequence 20

5.2.3 Concept Phase..... 21

5.2.4 Design Phase..... 21

5.2.5 Implementation Phase..... 22

6. HARMONIZATION FRAMEWORK FOR ADS-B IMPLEMENTATION 24

6.1 Background 24

6.2 Template of Harmonization Framework for ADS-B Implementation..... 25

7. SYSTEM INTEGRITY AND MONITORING 28

7.1 Introduction..... 28

7.2 Personnel Licensing and Training 28

7.3 System Performance Criteria for an ATC separation service..... 28

7.4 ATC system validation 29

7.4.1	Safety Assessment Guidelines	29
7.4.2	System safety assessment	29
7.4.3	Integration test	30
7.4.4	ATS Operation Manuals	30
7.4.5	ATS System Integrity	30
7.5	System Monitoring	31
7.5.1	Problem Reporting System (PRS)	31
7.5.2	The monitoring process	31
7.5.3	Distribution of confidential information	32
7.5.4	ADS-B problem reports	32
7.5.5	ADS-B periodic status report.....	32
7.5.6	Processing of Reports	33
7.6	APANPIRG.....	33
7.7	Local Data Recording and Analysis	33
7.7.1	Data recording	33
7.7.2	Local data collection.....	34
7.7.3	Avionics problem identification and correction	34
7.8	ADS-B Problem Report	35
7.8.1	Report Form.....	35
7.8.2	Description of Fields	36
7.9	ADS-B Performance Report Form.....	37
8.	RELIABILITY & AVAILABILITY CONSIDERATIONS	38
8.1	Reliability	38
8.2	Availability	38
8.3	Recommendations for high reliability/availability ADS-B systems	39
A:	System design	39
B:	Logistics strategy	40
C:	Configuration Management	41
D:	Training & Competency plans.....	42
E:	Data collection & Review.....	42
9.	ADS-B REGULATIONS AND PROCEDURES.....	43
9.1	Introduction.....	43
9.2	ADS-B Regulations	43
9.3	Factors to be considered when using ADS-B	44
9.3.1	Use of ADS-B Level data.....	44
9.3.2	Position Reporting Performance	44
9.3.3	GNSS Integrity Prediction Service	45
9.3.4	Sharing of ADS-B Data.....	45
9.3.5	Synergy between GNSS and ADS-B	46

9.4	Reporting Rates	47
9.4.1	General	47
9.5	Separation	47
9.5.1	General	47
9.5.2	Identification Methods	47
9.5.3	ADS-B Separation.....	47
9.5.4	Vertical Separation.....	48
9.6	Air Traffic Control Clearance Monitoring	48
9.6.1	General	48
9.6.2	Deviation from ATC clearances	48
9.7	Alerting service.....	48
9.8	Position Reporting	48
9.8.1	Pilot position reporting requirements in ADS-B coverage	48
9.8.2	Meteorological reporting requirement in ADS-B airspace	48
9.9	Phraseology.....	49
9.9.1	Phraseology standard	49
9.9.2	Operations of Mode S Transponder and ADS-B.....	49
9.10	Flight Planning.....	51
9.10.1	ADS-B Flight Planning Requirement – Flight Identity	51
9.10.2	ADS-B Flight Planning Requirements	51
9.10.3	Setting Flight Identification (Flight ID) in Cockpits	53
9.11	Procedures to Handle Non-compliant ADS-B Aircraft or Mis-leading ADS-B Transmissions	53
9.12	Emergency Procedures	56
10.	Security Issues Associated with ADS-B.....	57
10.1	Introduction.....	57
10.2	Considerations	57

Appendix 1 – An Example of Commissioning Checklist

Appendix 2 – Guidance Materials on Monitoring and Analysis of ADS-B Avionics Performance

Appendix 3 – A Template for ADS-B Mandate/Regulations for Aircraft Avionics

Appendix 4 – An Example of Advice to Operators Concerning Inconsistency between ADS-B Flight Planning and Surveillance Capability

Appendix 5 – Checklist of Common Items or Parameters for the Monitoring of ADS-B System

Appendix 6 – Baseline ADS-B Service Performance Parameters

Appendix 7 – Guidance Material on Generation, Processing and Sharing of ASTERIX Category 21 ADS-B Messages

1. INTRODUCTION

The Eleventh ICAO Air Navigation Conference held in 2003 recommended that States recognize ADS-B as an enabler of the global ATM concept bringing substantial safety and capacity benefits; support the cost-effective early implementation of it; and ensuring it is harmonized, compatible and interoperable with operational procedures, data linking and ATM applications.

The Twelve ICAO Air Navigation Conference held in 2012 endorsed the Aviation System Block Upgrades (ASBU) to provide a framework for global harmonization and interoperability of seamless ATM systems. Among the Block Upgrades, the Block 0 module “Initial Capability for Ground Surveillance” recommends States to implement ADS-B which provides an economical alternative to acquire surveillance capabilities especially for areas where it is technically infeasible or commercially unviable to install radars.

This ADS-B Implementation and Operations Guidance Document (AIGD) provides guidance material for the planning, implementation and operational application of ADS-B technology in the Asia and Pacific Regions.

The procedures and requirements for ADS-B operations are detailed in the relevant States’ AIP. The AIGD is intended to provide key information on ADS-B performance, integration, principles, procedures and collaboration mechanisms.

The content is based upon the work to date of the APANPIRG ADS-B Study and Implementation Task Force (SITF), the Surveillance Implementation Coordination Group (SURICG) and various ANC Panels developing provisions for the operational use of ADS-B. Amendment to the guidance material will be required as new/revised SARPs and PANS are published.

1.1 ARRANGEMENT OF THE AIGD

The AIGD consists of the following Parts:

Section 1	Introduction
Section 2	Acronyms and Glossary of Terms
Section 3	Reference Documents
Section 4	ADS-B Data
Section 5	ADS-B Implementation
Section 6	Template of Harmonization Framework for ADS-B Implementation
Section 7	System Integrity and Monitoring
Section 8	Reliability and Availability Considerations
Section 9	ADS-B Regulations and Procedures
Section 10	Security Issues Associated with ADS-B

1.2 DOCUMENT HISTORY AND MANAGEMENT

This document is managed by the APANPIRG. It was introduced as draft to the first Working Group meeting of the ADS-B SITF in Singapore in October 2004, at which it was agreed to develop the draft to an approved working document that provides implementation guidance for States. The first edition was presented to APANPIRG for adoption in August 2005. It is intended to supplement SARPs, PANS and relevant provisions contained in ICAO documentation and it will be regularly updated to reflect evolving provisions.

1.3 COPIES

Paper copies of this AIGD are not distributed. Controlled and endorsed copies can be found at the following web site: <http://www.icao.int/APAC/Pages/edocs.aspx>

Copy may be freely downloaded from the web site, or by emailing APANPIRG through the ICAO Asia and Pacific Regional Office who will send a copy by return email.

1.4 CHANGES TO THE AIGD

Whenever a user identifies a need for a change to this document, a Request for Change (RFC) Form (see Section 1.6 below) should be completed and submitted to the ICAO Asia and Pacific Regional Office. The Regional Office will collate RFCs for consideration by the Surveillance Implementation Coordination Group.

When an amendment has been agreed by a meeting of the Surveillance Implementation Coordination Group then a new version of the AIGD will be prepared, with the changes marked by an “|” in the margin, and an endnote indicating the relevant RFC, so a reader can see the origin of the change. If the change is in a table cell, the outside edges of the table will be highlighted; e.g.:

--	--	--

Final approval for publication of an amendment to the AIGD will be the responsibility of APANPIRG.

1.5 EDITING CONVENTIONS

(Intentionally blank)

1.7 AMENDMENT RECORD

Amendment Number	Date	Amended by	Comments
0.1	24 December 2004	W. Blythe H. Anderson	Modified draft following contributions from ADS-B SITF Working Group members. Incorporated to TF/3 Working Paper #3.
0.2 (1.0)	24 March 2005	H. Anderson	Final draft prepared at ADS-B SITF WG/3
0.3 (1.1)	03 June 2005	Nick King	Amendments following SASP WG/WHL meeting of May 2005
0.4	15 July 2005	CNS/MET SG/9	Editorial changes made
1.0	26 August 2005	APANPIRG/16	Adopted as the first Edition
2.0	25 August 2006	Proposed by ADS-B SITF/5 and adopted by APANPIRG/17	Adopted as the second Edition
3.0	7 September 2007	Proposed by ADS-B SITF/6 and adopted by APANPIRG/18	Adopted as the second amendment (3 rd edition)
4.0	5 September 2011	Proposed by ADS-B SITF/10 and adopted by APANPIRG/22	Adopted amendment on consequential change to the Flight Plan and additional material on the reliability and availability for ADS-B ground system
5.0	14 September 2012	Proposed by ADS-B SITF/11 and adopted by APANPIRG/23	Included sample template on harmonization framework
6.0	June 2013	Proposed by ADS-B SITF/12 and adopted by APANPIRG/24	Revamped to include the latest ADS-B developments and references to guidance materials on ADS-B implementation
7.0	September 2014	Proposed by ADS-B SITF/13 and adopted by APANPIRG/25	(i) Included guidance materials on monitoring and analysis of ADS-B equipped aircraft (ii) Included guidance materials on synergy between GNSS and ADS-B (iii) Revised ATC Phraseology (iv) Included clarification on Flight Planning
8.0	September 2015	Proposed by ADS-B SITF/14 and adopted by APANPIRG/26	(i) Updated the guidance materials on monitoring and analysis of ADS-B equipped aircraft (ii) Updated the categories of reported ADS-B avionics problems (iii) Updated the guidance materials on ADS-B flight

			<p>plan</p> <ul style="list-style-type: none"> (iv) Updated the guidance materials on disabling ADS-B transmissions (v) Remove reference to operational approval for use of ADS-B Out by ATC
9.0	September 2016	Proposed by ADS-B SITF/15 and adopted by APANPIRG/27	<ul style="list-style-type: none"> (i) Included a list of additional functional requirements for ADS-B integration (ii) Addition of a checklist of common items or parameters for monitoring of ADS-B System (iii) Amendment to emphasize the issue on potential incorrect processing of DO-260B downlinks by ADS-B ground stations during upgrade (iv) Updated the list of known ADS-B avionics problems (v) Included a general recommendation of technical solution on acquisition of Mode 3/A code information via Mode S downlink for DO-260 aircraft in ADS-B implementation with Mode A/C SSR environment
10.0	June 2017	Proposed by SURICG/2	<ul style="list-style-type: none"> (i) Updated “B787 position error with good NUC” in the list of known ADS-B avionics problems. (ii) Included new problem type “Incorrect Ground Bit Setting in ADS-B Avionics Downlink Data” and “A350 ADS-B on-ground performance” in the list of known ADS-B avionics problems. (iii) Amendment to the template for ADS-B Mandate / Regulations for Aircraft Avionics. (iv) Included a general recommendation to use ADS-B in overcoming the limitations of Mode A/C radar technology. (v) Included a general recommendation on carrying

			<p>out ICAO Aircraft Address Monitoring</p> <p>(vi) Aligned to replace NACp for NAC throughout the document</p> <p>(vii) Aligned to use ICAO Aircraft Address throughout the document</p>
11.0	April 2018	Proposed by SURICG/3	<p>(i) Editorial Updates – including /replacing ADS-B SITF with SURICG (Sections 1, 1.4, 2.1, 7.5.1, 7.5.5, 7.5.6, 7.6, 7.8.2)</p> <p>(ii) Correction of HPL Definition (Section 2.2)</p> <p>(iii) Update of reference documents as in Attachment 2 of WP/02</p> <p>(iv) Include reference to APRD (Section 7.5.1)</p> <p>(v) Update of sample regulations (Section 9.2)</p> <p>(vi) Update in Position Reporting Performance (Section 9.3.2)</p> <p>(vii) Update in GNSS Integrity Prediction Service (Section 9.3.3)</p> <p>(viii) Update name of RASMAG in Sharing of ADS-B Data (Section 9.3.4)</p> <p>(ix) Clarification of reporting rate requirements (Section 9.4.1)</p> <p>(x) Use of Ident during ADS-B emergencies.(Section 9.12)</p> <p>(xi) Appendix 1 missing from Version 10 – reinstate.</p> <p>(xii) Appendix 2 – update for available APRD.</p> <p>(xiii) Update to B787 service bulletin status. (Attachment A in Appendix 2)</p> <p>(xiv) replace "Date UTC" to "Start Time/Date UTC", replace "Time UTC" to "End Time/Date UTC" and related contents in the Report Form (Section 7.8.1)</p> <p>(xv) replace description of "Date UTC" as "UTC Time/Date when the event occurred", replace description of "Time UTC" as "UTC Time/Date when the event ended" as</p>

			<p>sometimes the problem will lasts across mid-night. (Section 7.8.2)</p> <p>(xvi) In Remote Control & Monitoring (RCMS) part, suggest to replace "ASTERIX Output Load" to "ASTERIX Output Load and Link Status" (Appendix 5)</p> <p>(xvii) Update on DO260A EMG issue (Section 9.12)</p> <p>(xviii) Update the link to the Guidance Material on generation, processing and sharing of ASTERIX (Section 4)</p> <p>(xix) Reference to Space based ADS-B and ATC automation as in WP12 is added under 5.1.4.4.6</p> <p>(xx) Updated Section 4 Managing the Problem in Appendix 2 to incorporate the General mechanism and procedure for blacklisting aircraft</p> <p>(xxi) Updated the Attachment A to Appendix 2 – List of known ADS-B avionics problems</p> <p>(xxii) Added Appendix 6 – Baseline ADS-B Service Performance Parameters</p> <p>(xxiii) Added Appendix 7 – Guidance Material on Generation, Processing and Sharing of ASTERIX Category 21 ADS-B Messages</p>
--	--	--	--

2. ACRONYM LIST & GLOSSARY OF TERMS

2.1 ACRONYM LIST

ACID	Aircraft Identification
ADS-C	Automatic Dependent Surveillance - Contract
ADS-B	Automatic Dependent Surveillance - Broadcast
AIGD	ADS-B Implementation and Operations Guidance Document
AIP	Aeronautical Information Publication
AIT	ADS-B Implementation Team
AMSL	Above Mean Sea Level
APANPIRG	Asia/Pacific Air Navigation Planning and Implementation Regional Group
APRD	ADS-B Avionics Problem Reporting Database
ARINC	Aeronautical Radio Incorporate
ATC	Air Traffic Control (or Air Traffic Controller)
ATM	Air Traffic Management
ATS	Air Traffic Services
ATSP	ATS Provider
ATSU	ATS unit
CNS	Communications, Navigation, Surveillance
CRC	Cyclic Redundancy Check
CDTI	Cockpit Display Traffic Information
DAIW	Danger Area Infringement Warning
FIR	Flight Information Region
FLTID	Flight Identification
FMS	Flight Management System
FOM	Figure of Merit used in ASTERIX messaging
GPS	Global Positioning System (USA)
HPL	Horizontal Protection Level
ICAO	International Civil Aviation Organization
MSAW	Minimum Safe Altitude Warning
MTBF	Mean Time Between Failures
MTCA	Medium Term Conflict Alert
MTTR	Mean Time To Restore
NACp	Navigation Accuracy Category
NIC	Navigation Integrity Category
PRS	Problem Reporting System
RAI	Restricted Area Intrusion
RAM	Route Adherence Monitoring
RAIM	Receiver Autonomous Integrity Monitoring
RFC	Request for Change
RNP	Required Navigation Performance
SIL	Source Integrity Level
SITF	Study and Implementation Task Force
STCA	Short Term Conflict Alert
SURICG	Surveillance Implementation Coordination Group

2.2 GLOSSARY OF TERMS

ADS-B In	An ADS-B system feature that enables the display of real time ADS-B tracks on a situation display in the aircraft cockpit.
ADS-B Out	An ADS-B system feature that enables the frequent broadcast of accurate aircraft position and vector data together with other information.
Asterix 21	Eurocontrol standard format for data message exchange
FOM (Figure of Merit)	A numeric value that is used to determine the accuracy and integrity of associated position data.
HPL (Horizontal Position Limit)	The containment radius within which the true position of the aircraft will be found for 99.999% of the time, or the probability indicated by the reported SIL value (DO-260A/B).
NACp (Navigational Accuracy Category)	Subfield used to announce the 95% accuracy limits for the horizontal position data being broadcast.
NIC (Navigational Integrity Category)	Subfield used to specify the containment radius integrity associated with horizontal position data.
NUCp (Navigation Uncertainty Category)	A numeric value that announces the integrity of the associated horizontal position data being broadcast.
SIL (Source Integrity Level)	Subfield used to specify the probability of the true position lying outside the containment radius defined by NIC without being alerted.

3. REFERENCE DOCUMENTS

Id	Name of the document	Reference	Date	Origin	Domain
1	Annex 2: Rules of the Air	Tenth Edition Including Amendment 43 dated 10/11/16	July 2005	ICAO	
2	Annex 4: Aeronautical Chart	Eleventh Edition including Amendment 59 dated 10/11/16	July 2009	ICAO	
3	Annex 10: Aeronautical Telecommunications, Vol. IV – Surveillance Radar and Collision Avoidance Systems	Fifth Edition	July 2014	ICAO	
4	Annex 11: Air Traffic Services	Fourteenth Edition	July 2016	ICAO	
5	Annex 15: Aeronautical Information Services	Fifteenth Edition	July 2016	ICAO	
6	PAN-ATM (Doc 4444/ATM501)	Sixteenth Edition	November 2016	ICAO	
7	Air Traffic Services Planning Manual (Doc 9426/AN924)	First Edition including Amendment 4 30/12/92	1984	ICAO	
8	Manual on Airspace Planning Methodology for the Determination of Separation Minima (Doc 9689/AN953)	First Edition including Amendment 1 dated 30/8/02	1998	ICAO	
9	Doc 9859 Safety Management Manual (SMM)	Third Edition	2013	ICAO	
10	Technical Provisions for Mode S Services and Extended Squitter (Doc 9871/AN460)	Second Edition including Amendment 1 dated 09/01/17	2012	ICAO	
11	Aeronautical Surveillance Manual (Doc 9924)	Second Edition	2017	ICAO	
12	ICAO Circular 326 AN/188 “Assessment of ADS-B and Multilateration Surveillance to Support Air Traffic Services and Guidelines for Implementation”.	First Edition	2012	ICAO	
13	Regional Supplementary Procedures (Doc 7030)	Fifth Edition including Amendment 9 dated 25/04/14	2008	ICAO	
14	Minimum Operational Performance Standards (MOPS) for 1090 MHz Automatic Dependent Surveillance – Broadcast (ADS-B) – including Change 1	RTCA DO-260 September 13, 2000 Change 1 to	2000 2006	RTCA	

		RTCA DO-260 June 27, 2006			
15	Minimum Operational Performance Standards for 1090 MHz Extended Squitter Automatic Dependent Surveillance – Broadcast (ADS-B) and Traffic Information Services – Broadcast (TIS-B)	RTCA DO-260A April 10, 2003	2003	RTCA	
	Minimum Operational Performance Standards for 1090 MHz Extended Squitter Automatic Dependent Surveillance – Broadcast (ADS-B) and Traffic Information Services – Broadcast (TIS-B) – Change 1	RTCA DO-260A Change 1 June 27, 2006	2006		
	Minimum Operational Performance Standards for 1090 MHz Extended Squitter Automatic Dependent Surveillance – Broadcast (ADS-B) and Traffic Information Services – Broadcast (TIS-B) – Change 2	RTCA DO-260A Change 2 December 13, 2006	2006		
16	Minimum Operational Performance Standards for 1090 MHz Extended Squitter Automatic Dependent Surveillance – Broadcast (ADS-B) and Traffic Information Services (TIS-B)	RTCA DO-260B December 2, 2009	2009	RTCA	
	Minimum Operational Performance Standards for 1090 MHz Extended Squitter Automatic Dependent Surveillance – Broadcast (ADS-B) and Traffic Information Services – Broadcast (TIS-B) – Corrigendum 1	RTCA DO-260B December 13, 2011	2011		

4. ADS-B DATA

APANPIRG has decided to use 1090MHz Extended Squitter data link for ADS-B data exchange in the Asia and Pacific Regions. In the longer term an additional link type may be required.

To ensure interoperability of ADS-B ground stations in the Asia Pacific (ASIA/PAC) Regions, during the 16th APANPIRG Meeting held in August 2005, the ASTERIX Category 21 version 0.23 (V0.23) which had incorporated DO260 standard was adopted as the baselined ADS-B data format for deployment of ADS-B ground stations and sharing of ADS-B data in the ASIA/PAC Regions. At this time, DO260A and DO260B standards were not defined.

This baselined version provides adequate information so that useful ATC operational services, including aircraft separation, can be provided. V0.23 can be used with DO260, DO260A and DO260B ADS-B avionics/ground stations to provide basic ATC operational services. However, V0.23 cannot fully support the more advanced capabilities offered by DO260A and DO260B.

As the avionics standards changed through the different versions of DO260, the ADS-B ground station processing also needed to change, so that downlinks received from aircraft would be correctly interpreted in construction of the ASTERIX Category 21 messages. It is important that States with “older generation” ADS-B ground stations designed to support DO260 or DO260A, take action to upgrade to support the latest ADS-B avionics standard as well as the older standards. DO260B avionics will become more common in the Asia Pacific region as the FAA and European ADS-B mandates for 2020 require this version.

States intending to implement ADS-B surveillance and share ADS-B data with others might consider to adopt a more updated version of ASTERIX in order to make use of the advanced capabilities offered by DO260A and DO260B compliant avionics.

A guidance material on generation, processing and sharing of ASTERIX Cat. 21 ADS-B messages is provided at **Appendix 7** for reference by States.

In this guidance material, the ADS-B data contained inside ASTERIX Cat 21 are classified as Group 1 (mandatory), Group 2 (Desirable) and Group 3 (Optional). It is required to transmit all data that are operationally desirable (Group 2), when such data are received from the aircraft, in addition to the data that are mandatory (Group 1) in ASTERIX messages. Whether Group 3 optional data will need to be transmitted or not should be configurable on item-by-item basis within the ADS-B ground station depending on specific operational needs.

It is considered necessary that all data that are mandatory in ASTERIX messages (i.e. Group 1 data items) and operationally desirable (i.e. Group 2 data items) when such data are received from aircraft, should be included in data sharing. In the event that the data have to be filtered, the list of optional data items (i.e. Group 3 data items) needs to be shared will be subject to mutual agreement between the two data sharing parties concerned.

5. ADS-B IMPLEMENTATION

5.1 INTRODUCTION

5.1.1 Planning

There are a range of activities needed to progress ADS-B implementation from initial concept level to operational use. This section addresses the issues of collaborative decision making, system compatibility and integration, while the second section of this chapter provides a checklist to assist States with the management of ADS-B implementation activities.

5.1.2 Implementation team to ensure international coordination

5.1.2.1 Any decision to implement ADS-B by a State should include consultation with the wider ATM community. Moreover, where ADS-B procedures or requirements will affect traffic transiting between states, the implementation should also be coordinated between States and Regions, in order to achieve maximum benefits for airspace users and service providers.

5.1.2.2 An effective means of coordinating the various demands of the affected organizations is to establish an implementation team. Team composition may vary by State or Region, but the core group responsible for ADS-B implementation planning should include members with multidiscipline operational expertise from affected aviation disciplines, with access to other specialists where required.

5.1.2.3 Ideally, such a team should comprise representatives from the ATS providers, regulators and airspace users, as well as other stakeholders likely to be influenced by the introduction of ADS-B, such as manufacturers and military authorities. All identified stakeholders should participate as early as possible in this process so that their requirements can be identified prior to the making of schedules or contracts.

5.1.2.4 The role of the implementation team is to consult widely with stakeholders, identify operational needs, resolve conflicting demands and make recommendations to the various stakeholders managing the implementation. To this end, the implementation team should have appropriate access to the decision-makers.

5.1.3 System compatibility

5.1.3.1 ADS-B has potential use in almost all environments and operations and is likely to become a mainstay of the future ATM system. In addition to traditional radar-like services, it is likely that ADS-B will also be used for niche application where radar surveillance is not available or possible. The isolated use of ADS-B has the potential to foster a variety of standards and practices that, once expanded to a wider environment, may prove to be incompatible with neighbouring areas.

5.1.3.2 Given the international nature of aviation, special efforts should be taken to ensure harmonization through compliance with ICAO Standards and Recommended Practices (SARPs). The choice of systems to support ADS-B should consider not only the required performance of individual components, but also their compatibility with other CNS systems and prevailing avionics standards.

5.1.3.3 The future concept of ATM encompasses the advantages of interoperable and seamless transition across flight information region (FIR) boundaries and, where necessary, ADS-B implementation teams should conduct simulations, trials and cost/benefit analysis to support these objectives.

5.1.4 Integration

5.1.4.1 ADS-B implementation plans should include the development of both business and safety cases. The adoption of any new CNS system has major implications for service providers, regulators and airspace users and special planning should be considered for the integration of ADS-B into the existing and foreseen CNS/ATM system. The following briefly discusses each element.

5.1.4.2 Communication system

5.1.4.2.1 The communication system is an essential element within CNS. An air traffic controller can now monitor an aircraft position in real time using ADS-B where previously only voice position reports were available. However, a communication system that will support the new services that result from the improved surveillance may be necessary. Consequently, there is an impact of the ongoing ADS-B related work on the communication infrastructure developments.

5.1.4.3 Navigation system infrastructure

5.1.4.3.1 ADS-B is dependent upon the data obtained from a navigation system (typically GNSS), in order to enable its functions and performance. Therefore, the navigation infrastructure should fulfill the corresponding requirements of the ADS-B application, in terms of:

- a) Data items; and
- b) Performance (e.g. accuracy, integrity, availability etc.).

5.1.4.3.2 This has an obvious impact on the navigation system development, which evolves in parallel with the development of the surveillance system.

5.1.4.4 Other surveillance infrastructure

5.1.4.4.1 ADS-B may be used to supplement existing surveillance systems or as the principal source of surveillance data. Ideally, surveillance systems will incorporate data from ADS-B and other sources to provide a coherent picture that improves both the amount and utility of surveillance data to the user. The choice of the optimal mix of data sources will be defined on the basis of operational demands, available technology, safety and cost-benefit considerations.

5.1.4.4.2 ADS-B is one of the cost-effective means in complementing and overcoming limitations of Mode A/C radars, including false targets, aircraft positions temporarily not displayed and split tracks, which could cause aircraft display issues on radar screens for ATC irrespective of brands of Air Traffic Management System being used. Within busy airspace, aircraft

could be managed at close lateral distance while vertically separated. In such situation, Mode A/C radars sometimes provide garbled detection, in the form of false targets due to overlapping replies from two or more aircraft. In the case of ADS-B, ADS-B data are broadcast in an omnidirectional, random and periodic intervals without suffering from the same issue. In addition, automatic data validation is usually done at ADS-B receivers to ensure integrity of ADS-B information received from the aircraft.

- 5.1.4.4.3 A guidance material on issues to be considered in ATC multi-sensor fusion processing including integration of ADS-B data is provided on the ICAO website <http://www.icao.int/APAC/Pages/edocs.aspx> for reference by States.
- 5.1.4.4.4 Acquisition of Mode 3/A code for DO-260 aircraft through Mode S downlink

There is a potential problem for some of the air traffic management systems (ATMS) for fusion of ADS-B targets with Mode A/C SSR targets, because a common identifier to the aircraft, Mode 3/A code, is not available through ADS-B. Then ATMS can only rely on proximity analysis of aircraft position and Mode C altitude to determine whether detections from two distinct types of surveillance sources belong to the same aircraft. This matching technique might introduce ambiguity in associating ADS-B with Mode A/C SSR targets for fused display.

States may consider enhancing their ADS-B ground stations to listen to Downlink Format 5 and 21 (DF 5 and 21) of Mode S interrogation replies which carry the Mode 3/A code of the same aircraft. As a result, ADS-B target reports of the same DO-260 aircraft can be filled with Mode 3/A code acquired from Mode S downlink to facilitate matching with Mode A/C SSR targets before transmitting to the ATMS.

The transmission of DF 5 and DF 21 messages from a Mode S aircraft requires to be triggered by ground-based Mode S interrogators, either through active or passive interrogation. For active interrogation, Mode S interrogators can be installed alongside with ADS-B ground stations for actively triggering DF 5 and DF 21 messages transmission from the aircraft. The interrogators shall follow ICAO standard to perform periodic all-call and roll-call to the aircraft in range. For passive interrogation, the ADS-B ground stations will only passively listen to the DF messages from the aircraft for acquiring the Mode 3/A code. It is required to ensure that Mode S interrogations are performed by external systems, such as A-SMGCS, MLAT system or Mode S radar under their coverage.

The above provides an interim solution during transition from Mode A/C SSR to Mode S SSR. After upgrading to Mode S SSR, ATMS can have an alternative means to make use of Flight ID or ICAO Aircraft Address to perform association between ADS-B and Mode S radar targets without ambiguity.

5.1.4.4.5 A guidance material on processing and displaying of ADS-B data at air traffic controller positions is provided on the ICAO website "<http://www.icao.int/APAC/Pages/edocs.aspx>" for reference by States.

5.1.4.4.6 Most of the ATC automation systems that support terrestrial ADS-B will also support space-based ADS-B without modifications. For more guidance, reference can be made to WP/12 on "ATC Automation Requirement and Space-based ADS-B" delivered during 3rd meeting of the SURICG.

5.1.4.5 Additional Functional Requirements for ADS-B Integration

5.1.4.5.1 The following list of functions could be considered by each individual States to see whether they are suitable for their own operational needs or applicable to local environment from ADS-B integration point of view:

- The priority of ADS-B sensor position data vs radar data could be adaptable;
- For ADS-B aircraft, receipt of the Mode S conspicuity code could trigger use of the Flight ID / ICAO Aircraft Address for flight plan correlation;
- If, due to sensor or aircraft capability limitation, no SSR code is received for an aircraft, the system could use Flight ID/ ICAO Aircraft Address for track correlation;
- For correlation based on Flight ID, the received ID could exactly match the ACID of the flight plan;
- For correlation based on ICAO Aircraft Address, the received address could match the address entered in the flight plan item 18 CODE/ keyword;
- The system could generate an alert for a correlated flight for which the Flight ID from the track does not match the flight plan ACID and/or the ICAO Aircraft Address from the track does not match the code given in the flight plan Item 18 CODE/ keyword;
- The system could allow the setting of ADS-B above or below the radar sources within the Surveillance Data Processor Tile Set on a per-tile basis;
- Priority could only apply to data received at or above the adapted NUCp, NACp, NIC, and/or SIL thresholds;
- The system could be configurable to either discard ADS-B data or display the track with an indication of ADS-B degradation if the received NUCp, NACp, NIC, or SIL is below an adapted threshold;
- If the system is configured to display the degraded track, the degraded position and status could only be displayed if there are no other surveillance sources available;

- The system could allow the adaptation of ADS-B emergency codes to map to special Mnemonics;
- The system could include an adaptable Downlinked Aircraft Parameters (DAP) field that invokes a popup with the following information from Mode-S and ADS-B aircraft:
 - Magnetic Heading
 - True Track Angle
 - Indicated Airspeed/Mach Number
 - Groundspeed
 - Track Angle Rate
 - True Airspeed
 - Roll Angle
 - Selected Altitude
 - Vertical Rate
- The system could generate a conformance alert if the Selected Altitude and the Cleared Flight Level do not match.
- The system could monitor¹ the ICAO Aircraft Address of individual aircraft and generate alert for the following cases:
 - ICAO Aircraft Address does not match with that specified in flight plan
 - ICAO Aircraft Address is all 0 or F (expressed in hexadecimal)
 - ICAO Aircraft Address is not defined in ICAO's allocation
 - Duplicated ICAO Aircraft Addresses exist within surveillance coverage
 - ICAO Aircraft Address changes during the flight

5.1.5 Coverage Predictions

5.1.5.1 Reliable and robust analysis and planning of ADS-B coverage to support seamless ATM initiative requires accurate and reliable coverage modelling. States should ensure that surveillance engineering/technical teams are provided with modelling tools to provide accurate and reliable coverage predictions for ATM planning and analysis.

5.2 IMPLEMENTATION CHECKLIST

5.2.1 Introduction

The purpose of this implementation checklist is to document the range of activities that needs to be completed to bring an ADS-B application from an initial concept to operational use. This checklist may form the basis of the terms of reference for an ADS-B implementation team, although some activities may be specific to individual stakeholders. An example of the checklist used by AirServices Australia is given at Appendix 1.

5.2.2 Activity Sequence

¹ Monitoring could be done by ATM system or other systems of the States/Administration

The activities are listed in an approximate sequential order. However, each activity does not have to be completed prior to starting the next activity. In many cases, a parallel and iterative process should be used to feed data and experience from one activity to another. It should be noted that not all activities will be required for all applications.

5.2.3 Concept Phase

a) construct operational concept:

- 1) purpose;
- 2) operational environment;
- 3) ATM functions; and
- 4) infrastructure;

b) identify benefits:

- 1) safety enhancements;
- 2) efficiency;
- 3) capacity;
- 4) environmental;
- 5) cost reductions;
- 6) access; and
- 7) other metrics (e.g. predictability, flexibility, usefulness);

c) identify constraints:

- 1) pair-wise equipage;
- 2) compatibility with non-equipped aircraft;
- 3) need for exclusive airspace;
- 4) required ground infrastructure;
- 5) RF spectrum;
- 6) integration with existing technology; and
- 7) technology availability;

d) prepare business case:

- 1) cost benefit analysis; and
- 2) demand and justification.

5.2.4 Design Phase

a) identify operational requirements:

- 1) security; and
- 2) systems interoperability;

b) identify human factors issues:

- 1) human-machine interfaces;
- 2) training development and validation;
- 3) workload demands;
- 4) role of automation vs. role of human;

- 5) crew coordination/pilot decision-making interactions; and
- 6) ATM collaborative decision-making;

c) identify technical requirements:

- 1) standards development;
- 2) prevailing avionics standards;
- 3) data required;
- 4) functional processing;
- 5) functional performance; and
- 6) required certification levels;

d) equipment development, test, and evaluation:

- 1) prototype systems built to existing or draft standards/specifications;
- 2) developmental bench and flight tests; and
- 3) acceptance test parameters; and
- 4) select and procure technology;

e) develop procedures:

- 1) pilot and controller actions and responsibilities;
- 2) phraseologies;
- 3) separation/spacing criteria and requirements;
- 4) controller's responsibility to maintain a monitoring function, if appropriate;
- 5) contingency procedures;
- 6) emergency procedures; and
- 7) develop AIP and Information documentation

f) prepare design phase safety case:

- 1) safety rationale;
- 2) safety budget and allocation; and
- 3) functional hazard assessment.

5.2.5 Implementation phase

a) prepare implementation phase safety case;

b) conduct operational test and evaluation:

- 1) flight deck and ATC validation simulations; and
- 2) flight tests and operational trials;

c) obtain systems certification:

- 1) aircraft equipment; and
- 2) ground systems;

d) obtain regulatory approvals:

- 1) air traffic certification of use;

e) implementation transition:

- 1) Promulgate procedures and deliver training
- 2) continue data collection and analysis;
- 3) resolve any unforeseen issues; and
- 4) continue feedback into standards development processes;

f) performance monitoring to ensure that the agreed performance is maintained.

5.2.5.1 Once the implementation project is complete, ongoing maintenance and upgrading of both ADS-B operations and infrastructure should continue to be monitored, through the appropriate forums.

6. HARMONIZATION FRAMEWORK FOR ADS-B IMPLEMENTATION

6.1 BACKGROUND

6.1.1 It is obvious that full benefits of ADS-B will only be achieved by its harmonized implementation and seamless operations. During the 6th meeting of ADS-B SEA/WG in February 2011, Hong Kong, China initiated to strengthen collaboration among concerned States/Administrations for harmonized ADS-B implementation and seamless operations along two ATS routes L642 and M771 with major traffic flow (MTF). An ad-hoc workgroup comprising concerned CAAs/ANSPs from Hong Kong, China, Mainland China, Vietnam and Singapore was subsequently formed to elaborate and agree on a framework regarding implementation timelines, avionics standards, optimal flight levels, and ATC and engineering handling procedures. As a coherent effort, ADS-B implementation along ATS routes L642 and M771 has been harmonized while Hong Kong, China and Singapore have published respective Aeronautical Information Circulars and Airworthiness Notices on ADS-B mandates for these two routes with effect on 12 December 2013.

6.1.2 It is considered that the above implementation framework for ATS routes L642/M771 would serve as a useful template for extension to other high density routes to harmonize ADS-B implementation. Paragraph 6.2 shows the detailed framework.

6.2 TEMPLATE OF HARMONIZATION FRAMEWORK FOR ADS-B IMPLEMENTATION

Harmonization Framework for ADS-B Implementation along ATS Routes L642 and M771			
No.	What to harmonize	What was agreed	Issue / what needs to be further discussed
1	Mandate Effective	Singapore (SG), Hong Kong (HK), China (Sanya) : 12 Dec 2013 Vietnam (VN) : to be confirmed	
2	ATC Operating Procedures	No need to harmonize	Refer to SEACG for consideration of the impact of expanding ADS-B surveillance on ATC Operating Procedures including Large Scale Weather procedures.
3	Mandate Publish Date	No need to harmonize	To publish equipment requirements as early as possible.

4	Flight Level	<p>SG, HK, CN :</p> <ul style="list-style-type: none"> - At or Above FL290 (ADS-B airspace) - Below FL290 (Non-ADS-B airspace) <p>VN to be confirmed</p>	
5	Avionics Standard (CASA/AMC2024)	<p>SG - CASA or AMC2024 or FAA AC No. 20-165 HK - CASA or AMC2024 or FAA AC No. 20-165 VN - CASA or AMC2024 or FAA AC No. 20-165 CN - CASA or AMC2024 or FAA AC No. 20-165</p>	<p>ADS-B Task Force agreed that DO260B will be accepted as well.</p> <p>SG, HK, and CN agreed their ADS-B GS will accept DO260, DO260A and DO260B by 1 July 2014 (Note 1)</p>
6	Flight Planning	<p>Before 15 Nov 2012, as per AIGD On or after 15 Nov 2012, as per new flight plan format</p>	
7	Aircraft Equippage		
7a)	Procedures if Aircraft Not Equipped or Aircraft without a Serviceable ADS-B Transmitting Equipment before Flight	<p>SG, HK, CN : FL280 and Below VN to be confirmed</p>	

7b)	Aircraft Equipped but Transmitting Bad Data (Blacklisted Aircraft)	For known aircraft, treat as non ADS-B aircraft.	Share blacklisted aircraft among concerned States/Administration
8	Contingency Plan		
8a)	Systemic Failure such as Ground System / GPS Failure	Revert back to current procedure.	
8b)	Avionics Failure or Equipped Aircraft Transmitting Bad Data in Flight	Provide other form of separation, subject to bilateral agreement. From radar/ADS-B environment to ADS-B only environment, ATC coordination may be able to provide early notification of ADS-B failure.	Address the procedure for aircraft transiting from radar to ADS-B airspace and from ADS-B to ADS-B airspace.
9	Commonly Agreed Route Spacing	SEACG	Need for commonly agreed minimal in-trail spacing throughout.

Note 1: Also included two ADS-B GS supplied by Indonesia at Matak and Natuna

7. SYSTEM INTEGRITY AND MONITORING

7.1 INTRODUCTION

The Communications, Navigation, Surveillance and Air Traffic Management (CNS/ATM) environment is an integrated system including physical systems (hardware, software, and communication networks), human elements (pilots, controllers and engineers), and the operational procedures for its applications. ADS-B is a surveillance system that may be integrated with other surveillance technologies or may also operate as an independent source for surveillance monitoring within the CNS/ATM system.

Because of the integrated nature of such system and the degree of interaction among its components, comprehensive system monitoring is recommended. The procedures described in this section aim to ensure system integrity by validation, identification, reporting and tracking of possible problems revealed during system monitoring with appropriate follow-up actions.

These procedures do not replace the ATS incident reporting procedures and requirements, as specified in PANS-ATM (Doc 4444), Appendix 4; ICAO's Air Traffic Services Planning Manual (Doc 9426), Chapter 3; or applicable State regulations, affecting the reporting responsibilities of parties directly involved in a potential ATS incident.

7.2 PERSONNEL LICENSING AND TRAINING

Prior to operating any element of the ADS-B system, operational and technical personnel shall undertake appropriate training as determined by the States, including compliance with the Convention on International Civil Aviation where applicable.

Notwithstanding the above requirement and for the purposes of undertaking limited trials of the ADS-B system, special arrangements may be agreed between the operator and an Air Traffic Services Unit (ATSU).

7.3 SYSTEM PERFORMANCE CRITERIA FOR AN ATC SEPARATION SERVICE

A number of States have introduced ADS-B for the provision of Air Traffic Services, including for surveillance separation. The ICAO Separation and Airspace Safety Panel (SASP) has completed assessment on the suitability of ADS-B for various applications including provision of aircraft separation based on comparison of technical characteristics between ADS-B and monopulse secondary surveillance radar. It is concluded that that ADS-B surveillance is better or at least no worse than the referenced radar, and can be used to provide separation minima as described in PANS-ATM (Doc 4444) whether ADS-B is used as a sole means of ATC surveillance or used together with radar, subject to certain conditions to be met. The assessment result is detailed in the ICAO Circular 326 AN/188 "Assessment of ADS-B and Multilateration Surveillance to Support Air Traffic Services and Guidelines for Implementation".

Regarding the use of ADS-B in complex airspace (as discussed in ICAO Circular 326), complex airspace may be considered to be airspace with the following characteristics:

- Higher aircraft density
- Higher route crossing point density
- A higher mixture of different aircraft performance levels
- A higher rate of aircraft manoeuvring (as distinct from straight and level flight).

The following recommendations need to be considered:

1. Whether complex or not, States are urged to consider whether the current or required surveillance system performance is better, equivalent or worse than the SASP reference.
2. If the current or required surveillance system used by a State is lower or equivalent in performance than the reference MSSR used in Circular 326 Appendix A, then that State may use the Appendix C performance criteria.
3. If the current or required surveillance system used by a State is higher performance than the reference MSSR used in Circular 326 Appendix A, then the State must ensure that the ADS-B system achieves the more demanding performance.
4. State should undertake, in all cases, a safety assessment that ensures that any additional risks and safety requirements already identified for the airspace where ADSB or MLAT is to be implemented, or any newly identified risks, are effectively controlled and risk is reduced to an acceptable level.

States intending to introduce ADS-B separation minima shall comply with provisions of PANS-ATM, Regional Supplementary Procedures (Doc 7030) and Annex 11 paragraph 3.4.1. States should adopt the guidelines contained in this document unless conformance with PANS-ATM specifications requires change.

7.4 ATC SYSTEM VALIDATION

7.4.1 Safety Assessment Guidelines

To meet system integrity requirements, States should conduct a validation process that confirms the integrity of their equipment and procedures. Such processes shall include:

- a) A system safety assessment for new implementations is the basis for definitions of system performance requirements. Where existing systems are being modified to utilize additional services, the assessment demonstrates that the ATS Provider's system will meet safety objectives;
- b) Integration test results confirming interoperability for operational use of airborne and ground systems; and
- c) Confirmation that the ATS Operation Manuals are compatible with those of adjacent providers where the system is used across a common boundary.

7.4.2 System safety assessment

The objective of the system safety assessment is to ensure the State that introduction and operation of ADS-B is safe. This can be achieved through application of the provisions of Annex 11 paragraph 2.27 and PANS-ATM Chapter 2. The safety assessment should be conducted for initial implementation as well as any future enhancements and should include:

- a) Identifying failure conditions;
- b) Assigning levels of criticality;
- c) Determining risks/ probabilities for occurrence;

- d) Identifying mitigating measures and fallback arrangements;
- e) Categorising the degree of acceptability of risks; and
- f) Operational hazard ID process.

Following the safety assessment, States should institute measures to offset any identified failure conditions that are not already categorized as acceptable. This should be done to reduce the probability of their occurrence to a level as low as reasonably practicable. This could be accomplished through system automation or manual procedures.

Guidance material on building a safety case for delivery of an ADS-B separation service is provided on the ICAO APAC website “<http://www.icao.int/APAC/Pages/edocs.aspx>” for reference by States.

7.4.3 Integration test

States should conduct trials with suitably equipped aircraft to ensure they meet the operational and technical requirements to provide an ATS. Alternatively, they may be satisfied by test results and analysis conducted by another State or organization deemed competent to provide such service. Where this process is followed, the tests conducted by another State or organization should be comparable (i.e. using similar equipment under similar conditions). Refer also to the *Manual on Airspace Planning Methodology for the Determination of Separation Minima* (Doc9689).

7.4.4 ATS Operation Manuals

States should coordinate with adjacent States to confirm that their ATS Operation Manuals contain standard operating procedures to ensure harmonization of procedures that impact across common boundaries.

7.4.5 ATS System Integrity

With automated ATM systems, data changes, software upgrades, and system failures can affect adjacent units. States shall ensure that:

- a) A conservative approach is taken to manage any changes to the system;
- b) Aircrew, aircraft operating companies and adjacent ATSU(s) are notified of any planned system changes in advance, where that system is used across a common boundary;
- c) ATSUs have verification procedures in place to ensure that following any system changes, displayed data is both correct and accurate;
- d) In cases of system failures or where upgrades (or downgrades) or other changes may impact surrounding ATS units, ATSUs should have a procedure in place for timely notification to adjacent units. Such notification procedures will normally be detailed in Letters of Agreement between adjacent units; and
- e) ADS-B surveillance data is provided with equal to or better level of protection and security than existing surveillance radar data.

7.5 SYSTEM MONITORING

During the initial period of implementation of ADS-B technology, routine collection of data is necessary in order to ensure that the system continues to meet or exceed its performance, safety and interoperability requirements, and that operational service delivery and procedures are working as intended. The monitoring program is a two-fold process. Firstly, summarised statistical data should be produced periodically showing the performance of the system. This is accomplished through ADS-B Periodic Status Reports. Secondly, as problems or abnormalities arise, they should be identified, tracked, analyzed and corrected and information disseminated as required, utilizing the ADS-B Problem Report.

Guidance materials on monitoring and analysis of ADS-B Avionics Performance are given at Appendix 2. Checklist of common items or parameters that could be considered for monitoring is summarized at Appendix 5 for reference.

7.5.1 Problem Reporting System (PRS)

The Problem Reporting System is tasked with the collection, storage and regular dissemination of data based on reports received from SURICG members. The PRS tracks problem reports and publish information from those reports to SURICG members. Problem resolution is the responsibility of the appropriate SURICG members.

The PRS Administrator shall:

- a) prepare consolidated problem report summaries for each SURICG meeting;
- b) collect and consolidate ADS-B Problem Reports; and
- c) maintain a functional website (with controlled access) to manage the problem reporting function.

The PRS is managed through the Asia Pacific ADS-B Avionics Problem Reporting Database (APRD) which is accessible to authorized users via <https://applications.icao.int/ADSB-APRD/login.aspx>.

7.5.2 The monitoring process

When problems or abnormalities are discovered, the initial analysis should be performed by the organization(s) identifying the problem. In addition, a copy of the problem report should be entered in to the PRS which will assign a tracking number. As some problems or abnormalities may involve more than one organization, the originator should be responsible for follow-up action to rectify the problem and forward the information to the PRS. It is essential that all information relating to the problem is documented and recorded and resolved in a timely manner.

The following groups should be involved in the monitoring process and problem tracking to ensure a comprehensive review and analysis of the collected data:

- a) ATS Providers;

- b) Organizations responsible for ATS system maintenance (where different from the ATS provider);
- c) Relevant State regulatory authorities;
- d) Communication Service Providers being used;
- e) Aircraft operators; and
- f) Aircraft and avionics manufacturers.

7.5.3 Distribution of confidential information

It is important that information that may have an operational impact on other parties be distributed by the authorised investigator to all authorised groups that are likely to be affected, as soon as possible. In this way, each party is made aware of problems already encountered by others, and may be able to contribute further information to aid in the solution of these problems. The default position is that all states agree to provide the data which will be de-identified for reporting and record keeping purposes.

7.5.4 ADS-B problem reports

Problem reports may originate from many sources, but most will fall within two categories; reports based on observation of one or more specific events, or reports generated from the routine analysis of data. The user would document the problem, resolve it with the appropriate party and forward a copy of the report to the PRS for tracking and distribution. While one occurrence may appear to be an isolated case, the receipt of numerous similar reports by the PRS could indicate that an area needs more detailed analysis.

To effectively resolve problems and track progress, the problem reports should be sent to the nominated point of contact at the appropriate organization and the PRS. The resolution of the identified problems may require:

- a) Re-training of system operators, or revision of training procedures to ensure compliance with existing procedures;
- b) Change to operating procedures;
- c) Change to system requirements, including performance and interoperability; or
- d) Change to system design.

7.5.5 ADS-B periodic status report

The ATS Providers should complete the ADS-B Periodic Status Report annually and deliver the report to the regional meeting of the SURICG. The Periodic Status Report should give an indication of system performance and identify any trend in system deficiencies, the resultant operational implications, and the proposed resolution, if applicable.

Communications Service Providers, if used, are also expected to submit Periodic Status Reports on the performance of the networks carrying ADS-B data at the annual regional meeting of the SURICG. These reports could also contain the details of planned or current upgrades to the network.

7.5.6 Processing of Reports

Each group in the monitoring process should nominate a single point of contact for receipt of problem reports and coordination with the other parties. This list will be distributed by the PRS Administrator to all parties to the monitoring process.

Each State should establish mechanisms within its ATS Provider and regulatory authority to:

- a) Assess problem reports and refer them to the appropriate technical or operational expertise for investigation and resolution;
- b) Coordinate with aircraft operators;
- c) Develop interim operational procedures to mitigate the effects of problems until such time as the problem is resolved;
- d) Monitor the progress of problem resolution;
- e) Prepare a report on problems encountered and their operational implications and forward these to the PRS;
- f) Prepare the ADS-B periodic status report at pre-determined times and forward these to the Secretary of the annual meeting of the SURICG; and
- g) Coordinate with any Communication Service Providers used.

7.6 APANPIRG

APANPIRG, with the assistance of its contributory bodies, shall oversee the monitoring process to ensure the ADS-B system continues to meet its performance and safety requirements, and that operational procedures are working as intended. The APANPIRG'S objectives are to:

- a) review Periodic Status Reports and any significant Problem Reports;
- b) highlight successful problem resolutions to SURICG members;
- c) monitor the progress of outstanding problem resolutions;
- d) prepare summaries of problems encountered and their operational implications; and
- e) assess system performance based on information in the PRS and Periodic Status Reports.

7.7 LOCAL DATA RECORDING AND ANALYSIS

7.7.1 Data recording

It is recommended that ATS Providers and Communication Service Providers retain the records defined below for at least 30 days to allow for accident/incident investigation processes. These records should be made available on request to the relevant State safety authority. Where data is sought from an adjacent State, the usual State to State channels should be used.

These recordings shall be in a form that permits a replay of the situation and identification of the messages that were received by the ATS system.

7.7.2 Local data collection

ATS providers and communications service providers should identify and record ADS-B system component failures that have the potential to negatively impact the safety of controlled flights or compromise service continuity.

7.7.3 Avionics problem identification and correction

ATS providers need to develop systems to :

- a) detect ADS-B avionics anomalies and faults
- b) advise the regulators and where appropriate the aircraft operators on the detected ADS-B avionics anomalies and faults
- c) devise mechanisms and procedures to address identified faults

Regulators need to develop and maintain systems to ensure that appropriate corrective actions are taken to address identified faults.

7.8 ADS-B PROBLEM REPORT

7.8.1 Report Form			PRS #
Start Time/Date UTC		End Time/Date UTC	
Registration		Aircraft ID	
Flight ID		ICAO Aircraft Address	
Aircraft Type			
Flight Sector/ Location			
ATS Unit			
Description / additional information			
Originator		Originator Reference number	
Organization			

7.8.2 Description of Fields

Field	Meaning
Number	A unique identification number assigned by the PRS Administrator to this problem report. Organizations writing problem reports are encouraged to maintain their own internal list of these problems for tracking purposes. Once the problems have been reported to the PRS and incorporated in the database, a number will be assigned by the PRS and used for tracking by the SURICG.
Start Time/Date UTC	UTC time/date when the event occurred.
End Time/Date UTC	UTC time/date when the event ended.
Registration	Registration number (tail number) of the aircraft involved.
Aircraft ID (ACID)	Coded equivalent of voice call sign as entered in FPL Item 7.
ICAO Aircraft Address	Unique ICAO Aircraft Address expressed in Hexadecimal form (e.g. 7432DB)
Flight ID (FLTID)	The identification transmitted by ADS-B for display on a controller situation display or a CDTI.
Flight Sector/Location	The departure airport and destination airport for the sector being flown by the aircraft involved in the event. These should be the ICAO identifiers of those airports. Or if more descriptive, the location of the aircraft during the event.
Originator	Point of contact at the originating organization for this report (usually the author).
Aircraft Type	The aircraft model involved.
Organization	The name of the organization (airline, ATS provider or communications service provider) that created the report.
ATS Unit	ICAO identifier of the ATC Center or Tower controlling the aircraft at the time of the event.
Description	<p>This should provide as complete a description of the situation leading up to the problem as is possible. Where the organization reporting the problem is not able to provide all the information (e.g. the controller may not know everything that happens on the aircraft), it would be helpful if they would coordinate with the other parties to obtain the necessary information. The description should include:</p> <ul style="list-style-type: none"> • A complete description of the problem that is being reported • The route contained in the FMS and flight plan • Any flight deck indications • Any indications provided to the controller when the problem occurred • Any additional information that the originator of the problem report considers might be helpful but is not included on the list above <p>If necessary to contain all the information, additional pages may be added. If the originator considers it might be helpful, diagrams and other additional information (such as printouts of message logs) may be appended to the report.</p>

7.9 ADS-B PERFORMANCE REPORT FORM			
Originating Organization			
Date of submission		Originator	
Report Period			
TECHNICAL ISSUES			
OPERATIONAL ISSUES			
GENERAL COMMENTS			

8. RELIABILITY & AVAILABILITY CONSIDERATIONS

Reliability and Availability of ADS-B systems should normally be equivalent or better than the reliability and availability of radar systems.

Guidance material on Reliability and Availability standards for ADS-B systems and supporting voice communications systems are included in the document “Baseline ADS-B Service Performance Parameters” at **Appendix 6**.

The “Baseline ADS-B Performance Parameters” document contains three Tiers of service performance parameters with different reliability and availability standards for each Tier. The appropriate Tier should be selected for the type of ADS-B service intended:

- (a) Tier 1 standards are for a high performance traffic separation service;
- (b) Tier 2 standards are for a traffic situational awareness service with procedural separation; and
- (c) Tier 3 standards are for a traffic advisory service (flight information service)

To achieve high operational availability of ADS-B systems to support aircraft separation services, it is necessary to operate with duplicated/redundant systems. If one system fails, the service continues using an unduplicated system. This is acceptable for a short period, whilst the faulty system is being repaired, because the probability of a second failure during the short time window of repairing is low.

However, it is necessary to ensure that the repair does not take too long. A long repair time increases the risk of an unexpected failure (loss of service continuity); which in turn, introduces potential loss of service (low availability) and loss of aircraft operational efficiency and/or safety impacts.

Checklist of common items or parameters that could be considered for monitoring is summarized at Appendix 5 for reference.

8.1 Reliability

8.1.1 Reliability is a measure of how often a system fails and is usually measured as Mean Time Between Failure (MTBF) expressed in hours. Continuity is a measure equivalent to reliability, but expressed as the probability of system failure over a defined period. In the context of this document, failure means inability to deliver ADS-B data to the ATC centre. I.e: Failure of the ADS-B system rather than an equipment or component failure.

8.1.2 Poor system MTBF has a safety impact because typically it causes unexpected transition from one operating mode to another. For example, aircraft within surveillance coverage that are safely separated by a surveillance standard distance (say, 5 NM) are unexpectedly no longer separated by a procedural standard distance (say 15 mins), due to an unplanned surveillance outage.

8.1.3 In general, reliability is determined by design (see para 8.3 B below)

8.2 Availability

8.2.1 Availability is a measure of how often the system is available for operational use. It is usually expressed as a percentage of the time that the system is available.

8.2.2 Poor availability usually results in loss of economic benefit because efficiencies are not available when the ATC system is operating in a degraded mode (eg using procedural control instead of say 5 NM separation).

8.2.3 Planned outages are often included as outages because the efficiencies provided to the Industry are lost, no matter what the cause of the outage. However, some organisations do not include planned outages because it is assumed that planned outages only occur when the facility is not required.

8.2.4 Availability is calculated as

$$\text{Availability (Ao)} = \text{MTBF}/(\text{MTBF}+\text{MDT})$$

where *MTBF* = Mean Time Between SYSTEM Failure

MDT = Mean Down Time for the SYSTEM

The MDT includes Mean Time To Repair (MTTR), Turn Around Time (TAT) for spares, and Mean Logistic Delay Time (MLDT)

NB: This relates to the failure of the system to provide a service, rather than the time between individual equipment failures. Some organisations use Mean Time Between Outage (MTBO) rather than MTBF.

8.2.5 Availability is directly a function of how quickly the SYSTEM can be repaired. Ie: directly a function of MDT. Thus availability is highly dependent on the ability & speed of the support organisation to get the system back on-line.

8.3 Recommendations for high reliability/availability ADS-B systems

A : System design can keep system failure rate low with long MTBF. Typical techniques are :

- to duplicate each element and minimise single points of failure. Automatic changeover or parallel operation of both channels keeps system failure rates low. Ie: the system keeps operating despite individual failures. Examples are :
 - Separate communication channels between ADS-B ground station and ATC centre preferably using different technologies or service providers eg one terrestrial and one satellite
- Consideration of Human factors in design can reduce the number of system failures due to human error. E.g. inadvertent switch off, incorrect software load, incorrect maintenance operation.
- Take great care with earthing, cable runs and lightning protection to minimise the risks of system damage
- Take great care to protect against water ingress to cables and systems
- Establish a system baseline that documents the achieved performance of the site that can be later be used as a reference. This can shorten troubleshooting in future.
- System design can also improve the MDT by quickly identifying problems and alerting maintenance staff. Eg Built in equipment test (BITE) can significantly contribute to lowering MDT.

B: Logistics strategy aims to keep MDT very low. Low MDT depends on logistic support providing short repair times. To achieve short repair times, ANSPs usually provide a range of logistics, including the following, to ensure that the outage is less than a few days :

- ensure the procured system is designed to allow for quick replacement of faulty modules to restore operations
- provide remote monitoring to allow maintainers to identify the faulty modules for transport to site
- provide support tools to allow technicians to repair faulty modules or to configure/setup replacement modules
- provide technicians training to identify & repair the faulty modules
- provide local maintenance depots to reduce the time it takes to access to the site
- provide documentation and procedures to “standardise” the process
- use an in-country spares pool to ensure that replacement modules are available within reasonable times
- use a maintenance contract to repair faulty modules within a specified turnaround time. I.e.: to replenish the spares pool quickly.

Whilst technical training and remote monitoring are usually considered by ANSPs, sometimes there is less focus on spares support.

Difficulties can be experienced if States :

- a) Fail to establish a spares pool – because procurement of spares at the time of failure can bring extensive delays due to :
- b) obtaining funds
- c) obtaining approval to purchase overseas
- d) obtaining approval to purchase from a “sole source”
- e) difficulties and delays in obtaining a quotation
- f) delays in delivery because the purchase was unexpected by the supplier
- g) Fail to establish a module repair contract resulting in :
 - long repair times
 - unplanned expenditure
 - inability for a supplier to repair modules because the supplier did not have adequate certainty of funding of the work

Spares pool

ANSPs can establish, preferably as part of their acquisition purchase, adequate spares buffer stock to support the required repair times. The prime objective is to reduce the time period that the system operates un-duplicated. It allows decoupling of the restoration time from the module repair time.

Module repair contract

ANSPs can also enter into a maintenance repair contract, preferably as part of their acquisition purchase, to require the supplier to repair or replace and deliver failed modules within a specified time – preferably with contractual incentives/penalties for compliance. Such support contracts are best negotiated as part of the acquisition contract when competition between vendors is at play to keep costs down. Sometimes it is appropriate to demand that the support contractor also keep a certain level of buffer stock of spares “in country”.

It is strongly recommended that maintenance support is purchased under the same contract as the acquisition contract.

The advantages of a module repair contract are :

- The price can be determined whilst in the competitive phase of acquisition – hence avoids excessive costs
- The contract can include the supplier bearing all shipping costs
- Can be funded by a define amount per year, which support the budget processes. If the costs are fixed, the supplier is encouraged to develop a reliable system minimising module repairs.
- It avoids delays and funding issues at the time of the module failure

Other typical strategies are:

- Establish availability and reliability objectives that are agreed organization wide. In particular agree System response times (SRT) for faults and system failure to ensure that MDT is achieved. An agreed SRT can help organizations to decide on the required logistics strategy including number, location and skills of staff to support the system.
- Establish baseline preventative maintenance regimes including procedures and performance inspections in conjunction with manufacturer recommendations for all subsystems
- Use remote control & monitoring systems to identify faulty modules before travel to site. This can avoid multiple trips to site and reduce the repair time
- Have handbooks, procedures, tools available at the site or a nearby depot so that travel time does not adversely affect down time
- Have adequate spares and test equipment ready at a maintenance depot near the site or at the site itself. Vendors can be required to perform analysis of the number of spares required to achieve low probability of spare “stock out”
- Have appropriate plans to cope with system and component obsolescence. It is possible to contractually require suppliers to regularly report on the ability to support the system and supply components.
- Have ongoing training programs and competency testing to ensure that staff are able to perform the required role

The detailed set of operational and technical arrangements in place and actions required to maintain a system through the lifecycle are often documented in a Integrated Logistics Support Plan.

C: Configuration Management aims to ensure that the configuration of the ground stations is maintained with integrity. Erroneous configuration can cause unnecessary outages. Normally configuration management is achieved by :

- Having clear organizational & individual responsibilities and accountabilities for system configuration.
- Having clear procedures in place which define who has authority to change configuration and records of the changes made including, inter alia

- The nature of the change including the reason
 - Impact of the change & safety assessment
 - An appropriate transition or cutover plan
 - Who approved the change
 - When the change was authorized and when the change was implemented
- Having appropriate test and analysis capabilities to confirm that new configurations are acceptable before operational deployment.
 - Having appropriate methods to deploy the approved configuration (Logistics of configuration distribution). Suggested methods;
 - Approved configuration published on intranet web pages
 - Approved configuration distributed on approved media

D: Training & Competency plans aim to ensure that staff has the skills to safety repairs Normally this is achieved by:

- Conduct of appropriate Training Needs Analysis (TNA) to identify the gap between trainee skill/knowledge and the required skill/knowledge.
- Development and delivery of appropriate training to maintainers
- Competency based testing of trainees
- Ongoing refresher training to ensure that skills are maintained even when fault rates are low

E: Data collection & Review :

Regular and scheduled review should be undertaken to determine whether reliability/availability objectives are being met. These reviews need to consider :

- Reports of actual achieved availability & reliability
- Data regarding system failures including “down time” needs to be captured and analysed so the ANSP actually knows what is being (or not being) achieved.
- Any failure trends that need to be assessed. This requires data capture of the root cause of failures
- Any environmental impacts on system performance, such coverage obstructions such as trees, planned building developments, corrosion, RFI etc. Changes in infrastructure may also be relevant including air conditioning (temperature/humidity etc) and power system changes.
- System problem reports especially those that relate to software deficiencies (design)
- System and component obsolescence
- Staff skills and need for refresher training

9. ADS-B REGULATIONS AND PROCEDURES

9.1 INTRODUCTION

ADS-B involves the transmission of specific data messages from aircraft and vehicle systems. These data messages are broadcast at approximately 0.5 second intervals and received at compatible ground stations that relay these messages to ATSU(s) for presentation on ATS situation displays. The following procedures relate to the use of ADS-B data in ATS ground surveillance applications.

The implementation of the ADS-B system will support the provision of high performance surveillance, enhancing flight safety, facilitating the reduction of separation minima and supporting user demands such as user-preferred trajectories.

9.2 ADS-B REGULATIONS

As agreed at APANPRIG 22/8, States intending to implement ADS-B based surveillance services may designate portions of airspace within their area of responsibility by:

- (a) mandating the carriage and use of ADS-B equipment; or
- (b) providing priority for access to such airspace for aircraft with operative ADS-B equipment over those aircraft not operating ADS-B equipment.

In publishing ADS-B mandate/regulations, States should consider to :

- define the ADS-B standards applicable to the State. For interoperability and harmonization, such regulations need to define both the standards applicable for the aircraft ADS-B position source and the ADS-B transmitter.
- define the airspace affected by the regulations and the category of aircraft that the regulation applies to.
- define the timing of the regulations allowing sufficient time for operators to equip. Experience in Asia Pacific Regions is that major international carriers are having high equipage rates of ADS-B avionics. However the equipage rates of ADS-B avionics for some regional fleets, business jets and general aviation are currently low and more time will be required to achieve high equipage rates.
- establish the technical and operational standards for the ground stations and air traffic management procedures used for ADS-B separation services, including the associated voice communications services.

States may refer to Appendix 3 on the template for ADS-B mandate/regulations for aircraft avionics. Some States listed below have published their ADS-B mandate/regulations on their web sites that could also be used for reference.

(a) Civil Aviation Safety Authority (CASA) of Australia
Civil Aviation Order 20.18 Compilation No. 4) 2014, Civil Aviation Order 82.1 (Compilation No. 13) ,
Civil Aviation Order 82.3 (No. 18), Civil Aviation Order 82.5 (No. 19)
<https://www.legislation.gov.au/Details/F2017C01115/Download>”

(b) Civil Aviation Department (CAD) of Hong Kong, China
Aeronautical Information Publication Supplement No. A01/16 dated 1 February 2016

[“https://www.ais.gov.hk/HK_AIP/supp/A01-16.pdf”](https://www.ais.gov.hk/HK_AIP/supp/A01-16.pdf)

(c) Civil Aviation Authority of Singapore (CAAS)
Aeronautical Information Publication (eAIP) Part 2 ENR 1.8 – Regional Supplementary Procedures – Section 7 – Automatic Dependent Surveillance Broadcast (ADS-B) Out exclusive airspace within parts of the Singapore FIR

[“https://fpl-1.caasaim.gov.sg/aip/2018-03-14/final/2018-03-14/html/index-en-GB.html”](https://fpl-1.caasaim.gov.sg/aip/2018-03-14/final/2018-03-14/html/index-en-GB.html)

(d) Federal Aviation Administration (FAA)
ADS-B Out Performance Requirements To Support Air Traffic Control (ATC) Service, Final Rule
<http://www.gpo.gov/fdsys/pkg/FR-2010-05-28/pdf/2010-12645.pdf>

States are encouraged to mandate forward fit for newly manufactured aircraft on and after 1 January 2020, having a maximum certified takeoff weight of 5700kg or greater, or having a maximum cruising true airspeed capability of greater than 250 knots, with ADS-B avionics compliant to Version 2 ES (equivalent to RTCA DO-260B) or later version².

9.3 FACTORS TO BE CONSIDERED WHEN USING ADS-B

9.3.1 Use of ADS-B Level data

The accuracy and integrity of pressure altitude derived level information provided by ADS-B are equivalent to Mode C level data provided through an SSR sensor and subject to the same operational procedures as those used in an SSR environment. Where the ATM system converts ADS-B level data to display barometric equivalent level data, the displayed data should not be used to determine vertical separation until the data is verified by comparison with a pilot reported barometric level.

9.3.2 Position Reporting Performance

The ADS-B data from the aircraft will include a NUCp/NIC/SIL/NACp categorization of the integrity and accuracy of the horizontal position data. This figure is determined from NIC/ NACp/ SIL values for DO260A/B compliant avionics and NUC values for DO260/ED102 compliant avionics.

In general, for 5NM separation, if the HPL value used to generate ADS-B quality indicators (NUC or NIC) is greater than 2 nautical miles the data is unlikely to be of comparable quality to that provided by a single monopulse SSR. ADS-B data should not be used for separation unless a suitable means of determining data integrity is used.

The key minimum performance requirements for an ADS-B system to enable the use of a 3 NM or 5 NM separation minimum in the provision of air traffic control is provided in the ICAO Circular 326 (especially Appendix C).

ADS-B reports with low integrity may be presented on situation displays, provided the controller is alerted (e.g. by a change in symbology and/or visual alert) to the change and the implications for the provision of separation. An ANS Provider may elect not to display ADS-B tracks that fail to meet a given position reporting performance criterion.

² Subject to endorsement by CNS/SG/22 in July 2018

9.3.3 GNSS Integrity Prediction Service

ADS-B uses GNSS for position determination. As such, availability of GNSS data has a direct influence on the provision of a surveillance service.

ATS Providers may elect to use a GNSS integrity prediction service to assist in determining the future availability of useable ADS-B data. The integrity prediction service alerts users to potential future loss or degradation of the ADS-B service in defined areas. When these alerts are displayed, the system is indicating to its users that at some time in the future the ADS-B positional data may be inadequate to support the application of ADS-B separation. It is recommended that the prediction service is made available to each ATSU that is employing ADS-B to provide a separation service, to ensure that air traffic controllers are alerted in advance of any predicted degradation of the GNSS service and the associated reduction in their ability to provide ADS-B separation to flights that are within the affected area. This is similar to having advance warning of a planned radar outage for maintenance.

ADS-B should not be used to provide separation between aircraft that will be affected by an expected period of inadequate position reporting integrity.

If an unpredicted loss of integrity occurs (including a RAIM warning report from aircrew) then;

- (a) ADS-B separation should not be applied by ATC to the particular aircraft reporting until the integrity has been assured; and
- (b) The controller should check with other aircraft in the vicinity of the aircraft reporting the RAIM warning, to determine if they have also been affected and establish alternative forms of separation if necessary.

9.3.4 Sharing of ADS-B Data

ADS-B Data-sharing for ATC Operations

Member States should consider the benefits of sharing ADS-B data received from aircraft operating in the proximity of their international airspace boundaries with adjacent States that have compatible technology in an effort to maximize the service benefits and promote operational safety.

Data sharing may involve the use of the data to provide separation services if all the requirements for delivery of separation services are satisfied. In some cases, States may choose to use a lower standard that supports surveillance safety nets and situational awareness whilst operations are conducted using procedural separation standards.

Any agreement on the sharing of surveillance data should be incorporated in Letters of Agreement between the States concerned. Such agreements may also include the sharing of VHF communication facilities.

A template for ADS-B data-sharing agreement is provided on the ICAO APAC website "<http://www.icao.int/APAC/Pages/edocs.aspx>" for reference by States.

ADS-B Data-sharing for Safety Monitoring

With endorsement of the methodology by both the ICAO Separation and Airspace Safety Panel (SASP) and the Regional Airspace Safety Monitoring Advisory Group (RASMAG), ADS-B

data can be used for calculating the altimetry system error (ASE) which is a measure of the height-keeping performance of an aircraft. It is an ICAO requirement that aircraft operating in RVSM airspace must undergo periodic monitoring on height-keeping performance. The existing methods to estimate aircraft ASE include use of a portable device, the Enhanced GPS Monitoring Unit, and ground-based systems called Height Monitoring Unit/Aircraft Geometric Height Measurement Element. The use of ADS-B data for height-keeping performance monitoring, on top of providing enhanced and alternative means of surveillance, will provide a cost-effective option for aircraft operators. States are encouraged to share ADS-B data to support the height-keeping performance monitoring of airframe.

Civil/Military ADS-B Data-sharing

Civil/military data sharing arrangements, including aircraft surveillance, were a key part of civil/military cooperation in terms of tactical operational responses and increasing trust between civil and military units.

Aircraft operating ADS-B technology transmit their position, altitude and identity to all listeners, conveying information from co-operative aircraft that have chosen to equip and publicly broadcast ADS-B messages. Thus there should be no defence or national security issues with the use and sharing of such data.

Some military transponders may support ADS-B using encrypted DF19 messages, but these data are normally not decoded or used at all by civil systems. In most cases today, tactical military aircraft are not ADS-B equipped or could choose to disable transmissions. In future, increasing numbers of military aircraft will be ADS-B capable, with the ability to disable these transmissions. ADS-B data sharing should not influence the decision by military authorities to equip or not equip with ADS-B. Moreover, it is possible for States to install ADS-B filters that prevent data from sensitive flights being shared. These filters can be based on a number of criteria and typically use geographical parameters to only provide ADS-B data to an external party if aircraft are near the boundary.

A guidance material on advice to military authorities regarding ADS-B data sharing is provided on the ICAO APAC website "<http://www.icao.int/APAC/Pages/edocs.aspx>" for reference by States.

9.3.5 Synergy of ADS-B and GNSS

States intending to implement GNSS/PBN or ADS-B should consider the efficiency of implementing the other technology at the same time due to the inherent efficiencies in doing so. GNSS systems provide navigation solutions to IFR aircraft for the conduct of enroute, terminal and non-precision approaches. The use of GNSS/PBN can provide higher performance and higher safety. Transition to GNSS can avoid significant ground infrastructure costs.

ADS-B systems provide surveillance based upon GNSS position source. ADS-B provides high performance and high update surveillance for both air-air and ATC surveillance. Transition to ADS-B can avoid the costs associated with ground based radar infrastructure. ADS-B system installations rely on acceptable GNSS equipment being installed in the aircraft to provide the position source and integrity.

If the fleet is equipped with ADS-B, they will already have most of the requirements to use GNSS for navigation satisfied. Similarly, if aircraft have suitable GNSS on board, they will have a position source to support ADS-B. It is noted however, that some care is needed to ensure that the requirements of GNSS/PBN and surveillance are both satisfied.

There is significantly less cost for these systems to be installed in an aircraft at the same time. A single installation of GNSS & ADS-B will involve :

- a single design activity instead of two
- a single downtime instead of two
- installation of the connection between GPS and ADS-B transponder
- a single test, certification and aircraft flight test

For the affected aviation community (ANSP, regulator and operator), the lessons learnt and issues faced in both GNSS and ADS-B have significant commonality. This can lead to efficiencies in Industry education and training.

9.4 Reporting Rates

9.4.1 General

The ADS-B system shall maintain a reporting rate that ensures at least an equivalent degree of accuracy, integrity and availability as specified by the performance requirements of a radar system that is used to provide a similar ATC service. The standard reporting rate is approximately 0.5 second from the aircraft, but the rate of update provided to the ATM system (for the situation display) may be less frequent (e.g. 5 seconds), provided performance requirements for the service are achieved. Reporting rate requirements are included in the document “Baseline ADS-B Service Performance Parameters” which is available at Appendix 6.

9.5 SEPARATION

9.5.1 General

ADS-B data may be used in combination with data obtained by other means of surveillance (such as radar, flight plan track, ADS-C) for the application of separation provided appropriate minima as determined by the State are applied. It should be noted that the quality of communications will have a bearing on the determination of appropriate minima.

All safety net features (MSAW, STCA, MTCA, RAM and DAIW/ RAI etc) should possess the same responsiveness as equivalent radar safety net features.

9.5.2 Identification Methods

Some of the methods approved by ICAO for establishing identification with radar, may be employed with ADS-B (see PANS-ATM chapter 8). One or more of the following identification procedures are suggested:

- a) direct recognition of the aircraft identification in an ADS-B label on a situation display;
- b) transfer of ADS-B identification;
- c) observation of compliance with an instruction to TRANSMIT ADS-B IDENT.

Note: In automated systems, the “IDENT” feature may be presented in different ways, e.g. as a flashing of all or part of the position indication and associated label.

9.5.3 ADS-B Separation

ADS-B Separation minima has been incorporated by ICAO in PANS-ATM (Doc 4444), and in Regional Supplementary Procedures (Doc 7030).

In a mixed surveillance environment, States should use the larger separation standard applicable between aircraft in the conflict pair being considered.

9.5.4 Vertical separation

9.5.4.1 Introduction

The ADS-B level data presented on the controllers situation display shall normally be derived from barometric pressure altitude. In the event that barometric altitude is absent, geometric altitude shall not be displayed on displays used for provision of air traffic services. Geometric altitude may be used in ATM systems for other purposes.

9.5.4.2 Vertical tolerance standard

The vertical tolerances for ADS-B level information should be consistent with those applied to Mode C level information.

9.5.4.3 Verification of ADS-B level information

The verification procedures for ADS-B level information shall be the same as those employed for the verification of Mode C level data in a radar environment.

9.6 AIR TRAFFIC CONTROL CLEARANCE MONITORING

9.6.1 General

ADS-B track data can be used to monitor flight path conformance with air traffic control clearances.

9.6.2 Deviations from ATC clearances

The ATC requirements relating to monitoring of ADS-B traffic on the situation display should be similar to those contained in PANS-ATM Ch.8.

9.7 ALERTING SERVICE

For ADS-B equipped aircraft, the provision of an alerting service should be based on the same criteria as applied within a radar environment.

9.8 POSITION REPORTING

9.8.1 Pilot position reporting requirements in ADS-B coverage

States should establish voice and/or CPDLC position reporting procedures consistent with those applicable with radar for aircraft that have been identified by ATC.

9.8.2 Meteorological reporting requirements in ADS-B airspace

ATSUs may promulgate in the AIP meteorological reporting requirements that apply within the nominated FIR. The meteorological reporting data required and the transmission methods to be used by aircrew shall be specified in AIP.

9.9 PHRASEOLOGY

9.9.1 Phraseology Standard

States should use common phraseology for both ADS-B and radar where possible, and should note the requirement for ADS-B specific phraseology in some instances. States shall refer to PANS ATM Chapter 12 for ADS-B phraseology:

ADS-B EQUIPMENT DEGRADATION

ADS-B OUT OF SERVICE (appropriate information as necessary).

TO REQUEST THE CAPABILITY OF THE ADS-B EQUIPMENT

- a) ADVISE ADS-B CAPABILITY;
 - *b) ADS-B TRANSMITTER (data link);
 - *c) ADS-B RECEIVER (data link);
 - *d) NEGATIVE ADS-B.
- * Denotes pilot transmission.

Note: For (b) and (c) – the options are not available for aircraft that are not equipped.

TO REQUEST RESELECTION OF AIRCRAFT IDENTIFICATION
REENTER FLIGHT IDENTIFICATION.

Note: For some aircraft, this option is not available in-flight

TERMINATION OF RADAR AND/OR ADS-B SERVICE
IDENTIFICATION LOST [reasons] (instructions).

TO REQUEST THE OPERATION OF THE MODE S OR ADS-B IDENT FEATURE
SQUAWK IDENT.

Note: For some standalone ADS-B equipage affecting General Aviation, the option of “TRANSMIT ADS-B IDENT” may be available

TO REQUEST AIRCRAFT SWITCHING TO OTHER TRANSPONDER OR TERMINATION
OF ADS-B TRANSMITTER OPERATION

- a) SWITCH TO OTHER TRANSPONDER
- b) STOP ADS-B TRANSMISSION. SQUAWK (code) ONLY.

Note:

a) In many cases the ADS-B transmitter cannot be operated independently of the SSR transponder and switching off the ADS-B transmission would also switch off the SSR transponder operation

b) “STOP ADS-B TRANSMISSION” applies only to aircraft that have the facility to switch off the ADS-B transmission, while maintaining SSR operation.

9.9.2 Operations of Mode S Transponder and ADS-B

It should be noted that independent operations of Mode S transponder and ADS-B will not be possible in many aircraft (e.g. where ADS-B is solely provided by 1090 MHz extended squitter emitted from the transponder). Additionally, some desirable but optional features of ADS-B transmitters may not be fitted in some aircraft. Controller training on this issue, as it relates to the following examples of radio telephony and/or CPDLC phraseology is recommended.

9.9.2.1 STOP ADSB TRANSMISSION or STOP SQUAWK

Issue: In most commercial aircraft, a common “transponder control head” is used for SSR transponder, ACAS and ADS-B functionality. In this case, a pilot who complies with the instruction to stop operation of one system will also need to stop operation of the other systems – resulting in a loss of surveillance not intended or expected by the controller.

ATC need to be aware that an instruction to “Stop ADS-B Transmission” may require the pilot to switch off their transponder that will then stop all other functions associated with the transponder operations (such as ACARs etc). Pilots need to be aware of their aircraft’s equipment limitations, the consequences of complying with this ATC instruction, and be aware of their company policy in regard to this. As with any ATC instruction issued, the pilot should advise ATC if they are unable to comply.

Recommendation: It is recommended that the concatenated phrases STOP ADSB TRANSMISSION, SQUAWK (code) ONLY or STOP SQUAWK, TRANSMIT ADSB ONLY are used. It is recommended that controller training highlights the possible consequences of **issuing** these instructions and that pilot training highlights the consequences of **complying** with this instruction. It is also recommended that aircraft operators have a clearly stated policy on procedures for this situation. Should a pilot respond with UNABLE then the controller should consider alternative solutions to the problem that do not remove the safety defences of the other surveillance technologies. This might include manual changes to flight data, coordination with other controllers and/or change of assigned codes or call signs.

Very few aircraft provide the capability to turn off ADS-B without turning off TCAS. It is not recommended to switch off ATC transponders (& remove TCAS protection). The only action for most pilots of aircraft transmitting misleading ADS-B data in response to ATC requests is to recycle the transponder, or switch to the alternate transponder as appropriate. Besides, aircraft that do not support ADS-B OFF should have the details included in the flight manual including the undesirability of disabling TCAS.

9.9.2.2 STOP ADSB ALTITUDE TRANSMISSION [WRONG INDICATION or reason] and TRANSMIT ADSB ALTITUDE

Issue: Most aircraft will not have separate control of ADSB altitude transmission. In such cases compliance with the instruction may require the pilot to stop transmission of all ADSB data and/or Mode C altitude – resulting in a loss of surveillance not intended or expected by the controller.

Recommendation: It is recommended that, should the pilot respond with UNABLE, the controller should consider alternative solutions to the problem that do not remove the safety defences of other surveillance data. This might include a procedure that continues the display of incorrect level information but uses pilot reported levels with manual changes to flight data and coordination with other controllers.

9.9.2.3 TRANSMIT ADS-B IDENT

Issue: Some aircraft may not be capable or the ADSB SPI IDENT control may be shared with the SSR SPI IDENT function.

Recommendation: It is recommended that controllers are made aware that some pilots are unable to comply with this instruction. An alternative means of identification that does not rely on the ADSB SPI IDENT function should be used.

9.10 FLIGHT PLANNING

9.10.1 ADS-B Flight Planning Requirement – Flight Identity

The aircraft identification (ACID) must be accurately recorded in section 7 of the ICAO Flight Plan form as per the following instructions:

Aircraft Identification, not exceeding 7 characters is to be entered both in item 7 of the flight plan and replicated exactly when set in the aircraft (for transmission as Flight ID) as follows:
Either,

- a) The ICAO three-letter designator for the aircraft operating agency followed by the flight identification (e.g. KLM511, BAW213, JTR25), when:

in radiotelephony the callsign used consists of the ICAO telephony designator for the operating agency followed by the flight identification (e.g. KLM 511, SPEEDBIRD 213, HERBIE 25).

Or,

- b) The registration marking of the aircraft (e.g. EIAKO, 4XBCE, OOTEK), when:
- 1) in radiotelephony the callsign used consists of the registration marking alone (e.g. EIAKO), or preceded by the ICAO telephony designator for the operating agency (e.g. SVENAIR EIAKO),
 - 2) the aircraft is not equipped with radio.

Note 1: No zeros, hyphens, dashes or spaces are to be added when the Aircraft Identification consists of less than 7 characters.

Note 2: Appendix 2 to PANS-ATM refers. ICAO designators and telephony designators for aircraft operating agencies are contained in ICAO Doc 8585.

9.10.2 ADS-B Flight Planning Requirements

9.10.2.1 ICAO Flight Plan Item 10 – Surveillance Equipment and Capabilities

An appropriate ADS-B designator shall be entered in item 10 of the flight plan to indicate that the flight is capable of transmitting ADS-B messages.

These are defined in ICAO DOC 4444 as follows:

B1 ADS-B with dedicated 1090 MHz ADS-B “out” capability

- B2 ADS-B with dedicated 1090 MHz ADS-B “out” and “in” capability
- U1 ADS-B “out” capability using UAT
- U2 ADS-B “out” and “in” capability using UAT
- V1 ADS-B “out” capability using VDL Mode 4
- V2 ADS-B “out” and “in” capability using VDL Mode 4

During the ADS-B SITF/13 meeting held in April 2014, clarification of the B1 and B2 descriptors was recommended as follows. This will be progressed for change to ICAO DOC 4444, but may take some time for formal adoption:

- B1 ADS-B “out” capability using 1090 MHz extended squitter
- B2 ADS-B “out” and “in” capability using 1090 MHz extended squitter

States should consider use of the revised descriptors in AIP.

9.10.2.2 ICAO Flight Plan Item 18 – Other Information

Where required by the appropriate authority the ICAO Aircraft Address (24 Bit Code) may be recorded in Item 18 of the ICAO flight plan, in hexadecimal format as per the following example:

CODE/7C432B

States should note that use of hexadecimal code may be prone to human error and is less flexible in regard to airframe changes for a notified flight.

9.10.2.3 Transponder Capabilities

When an aircraft is equipped with a mode S transponder, that transmits ADS-B messages, according to ICAO Doc 4444, an appropriate Mode S designator should also be entered in item 10; i.e.: either s

- E Transponder — Mode S, including aircraft identification, pressure-altitude and extended squitter (ADS-B) capability, or
- L Transponder — Mode S, including aircraft identification, pressure-altitude, extended squitter (ADS-B) and enhanced surveillance capability.

During the ADS-B SITF/13 meeting held in April 2014, clarification of the E and L descriptors was recommended as follows. This will be progressed for change to ICAO DOC 4444, but may take some time for formal adoption:

- E Transponder — Mode S, including aircraft identification, pressure-altitude and ADS-B capability, or
- L Transponder — Mode S, including aircraft identification, pressure-altitude, ADS-B and enhanced surveillance capability.

States should consider use of the revised descriptors in AIP.

9.10.2.4 Inconsistency between ADS-B Flight Planning and Surveillance Capability

Inconsistency between flight planning of ADS-B and surveillance capability of an aircraft can impact on ATC planning and situational awareness. States are encouraged to monitor for consistency between flight plan indicators and actual surveillance capability. Where discrepancies are identified, aircraft operators should be contacted and instructed to correct flight plans, or

general advice (as appropriate to the operational environment and type of flight planning problems) should be issued to aircraft operators. An example of such advice is provided at Appendix 4.

9.10.3 Setting Aircraft Identification (Flight ID) in Cockpits

(a) Flight ID Principles

The aircraft identification (sometimes called the flight identification or FLTID) is the equivalent of the aircraft callsign and is used in both ADS-B and Mode S SSR technology. Up to seven characters long, it is usually set in airline aircraft by the flight crew via a cockpit interface. It enables air traffic controllers to identify and aircraft on a display and to correlate a radar or ADS-B track with the flight plan data. Aircraft identification is critical, so it must be entered carefully. Punching in the wrong characters can lead to ATC confusing one aircraft with another.

It is important that the identification exactly matches the aircraft identification (ACID) entered in the flight notification.

Intuitive correlation between an aircraft's identification and radio callsign enhances situational awareness and communication. Airline aircraft typically use a three letter ICAO airline code used in flight plans, NOT the two letter IATA codes.

(b) Setting Flight ID

The callsign dictates the applicable option below for setting ADS-B or Mode S Flight ID:

- (i) the flight number using the ICAO three-letter designator for the aircraft operator if a flight number callsign is being used (e.g. QFA1 for Qantas 1, THA54 for Thai 54).
- (ii) the nationality and registration mark (without hyphen) of the aircraft if the callsign is the full version of the registration (e.g. VHABC for international operations).
- (iii) The registration mark alone of the aircraft if the callsign is the abbreviated version of the registration (eg ABC for domestic operations).
- (iv) The designator corresponding to a particular callsign approved by the ANSP or regulator (e.g. SPTR13 for firepotter 3).
- (v) The designator corresponding to a particular callsign in accordance with the operations manual of the relevant recreational aircraft administrative organization (e.g. G123 for Gyroplane 123).

9.11 PROCEDURES TO HANDLE NON-COMPLANT ADS-B AIRCRAFT OR MIS-LEADING ADS-B TRANSMISSIONS

ADS-B technology is increasingly being adopted by States in the Asia/Pacific Region. Asia/Pacific Region adopted 1090 extended squitter technology. Reliance on ADS-B transmissions can be expected to increase over the coming years.

Currently a number of aircraft are transmitting ADS-B data which is misleading or non-compliant with the ICAO standards specified in Annex 10. Examples include:

- a) aircraft broadcasting incorrect message formats;

- b) aircraft broadcasting inertial positional data and occasionally indicating in the messages that the data has high integrity when it does not;
- c) using GPS sources that do not generate correct integrity data, whilst indicating in the messages that the data has high integrity;
- d) transmitting ADS-B data with changing (and incorrect) flight identity; and
- e) transmitting ADS-B data with incorrect flight identity continuously.

If the benefits of ADS-B are to flow to the aviation industry, misleading and non-compliant ADS-B transmissions need to be curtailed to the extent possible.

The transmission of a value of zero for the NUCp or the NIC or the NACp or the SIL by an aircraft indicates a navigational uncertainty related to the position of the aircraft or a navigation integrity issue that is too significant to be used by air traffic controllers.

As such, the following procedure currently stipulated in the Regional Supplementary Procedures Doc 7030³, shall be applicable in the concerned FIRs on commencement of ADS-B based surveillance services notified by AIP or NOTAM:

If an aircraft operates within an FIR where ADS-B-based ATS surveillance service is provided, and

- a) carries 1090 extended squitter ADS-B transmitting equipment which does not comply with one of the following:
 - 1) EASA AMC 20-24; or
 - 2) the equipment configuration standards in Appendix XI of Civil Aviation Order 20.18 of the Civil Aviation Safety Authority of Australia; or
 - 3) installation in accordance with the FAA AC No. 20-165 – Airworthiness Approval of ADS-B; or
- b) the aircraft ADS-B transmitting equipment becomes unserviceable resulting in the aircraft transmitting misleading information;

then:

- a) except when specifically authorized by the appropriate ATS authority, the aircraft shall not fly unless the equipment is:
 - 1) deactivated; or
 - 2) transmits only a value of zero for the NUCp or NIC or NACp or SIL

States may elect to implement a scheme to blacklist those non-compliant aircraft or aircraft consistently transmitting mis-leading ADS-B information, so as to refrain the aircraft from being displayed to ATC. Please refer Appendix 2 for guidance in implementing the blacklist scheme.

A sample template is given below for reference by States to publish the procedures to handle non-compliant ADS-B aircraft or misleading ADS-B transmissions in their ADS-B mandate/regulations:

³ SURICG/2 recommended States/Administrations to update their ADS-B Avionics Equipage Requirements to align with the template in Appendix 3

After <insert earliest date that ADS-B may be used for any relevant operational purpose> if an aircraft carries ADS-B transmitting equipment which does not comply with :

- (a) European Aviation Safety Agency - Certification Considerations for the Enhanced ATS in Non-Radar Areas using ADS-B Surveillance (ADS-B-NRA) Application via 1090 MHz Extended Squitter (AMC 20-24), or
- (b) European Aviation Safety Agency - Certification Specifications and Acceptable Means of Compliance for Airborne Communications, Navigation and Surveillance Subpart D — Surveillance (SUR) (CS-ACNS.D.ADS-B), or
- (c) Federal Aviation Administration – Advisory Circular No: 20-165A (or later versions) Airworthiness Approval of Automatic Dependent Surveillance – Broadcast (ADS-B) Out Systems, or
- (d) the equipment configuration standards in Appendix XI of Civil Aviation Order 20.18 of the Civil Aviation Safety Authority of Australia.

or the aircraft ADS-B transmitting equipment becomes unserviceable resulting in the aircraft transmitting misleading information;

the aircraft must not fly unless equipment is:

- (a) deactivated; or
- (b) set to transmit only a value of zero for the NUCp or NIC or NACp or SIL.

Note:

1. It is considered equivalent to deactivation if NUCp or NIC or NACp or SIL is set to continually transmit only a value of zero.
2. Regulators should take appropriate action to ensure that such regulations are complied with.
3. ATC systems should discard ADS-B data when NUC or NIC or NACp or SIL =0.

9.12 EMERGENCY PROCEDURES

ATC surveillance systems should provide for the display of safety-related alerts and warnings, including conflict alert, minimum safe altitude warning, conflict prediction and unintentionally duplicated SSR codes and aircraft identifications.

The ADS-B avionics may transmit emergency status messages to any ADS-B ground station within coverage. The controller receiving these messages should determine the nature of the emergency, acknowledge receipt if appropriate, and initiate any assistance required. An aircraft equipped with ADS-B might operate the emergency and/or urgency mode as follows:

- a) emergency;
- b) no communications;
- c) unlawful interference;
- d) minimum fuel; and/or
- e) medical.

Selection of an emergency transponder code (e.g. 7600) automatically generates an emergency indication in the ADS-B message. However, some ADS-B transponders may only generate a generic emergency indication. That means, the specific type of emergency, e.g., communication failure, is not always conveyed to the controller in an ADS-B environment. The controller may only receive a generic emergency indication irrespective of the emergency codes being selected by the pilot.

In some early ADS-B avionics configurations, when a generic emergency indication is being transmitted, a request to “Transmit ADS-B Ident” or “Squawk Ident” may not result in the Ident indication being displayed in the ATC System. This is because the emergency and ident flags share the same data elements in the ADS-B downlink message.

Due to limitations of some ADS-B transponders, procedures should be developed for ATC to confirm the types of emergency with pilots based on operational needs of States.

In contrast to DO260 avionics, for DO-260A avionics, the transmission of an Emergency/Priority status message in the ADS-B message set will also include the original MODE A code allocated by ATC. When the aircraft resets the MODE A code to the original allocated code the ground station can retain the Emergency/Priority status in the Asterix message, for up to 100 seconds, even though the aircraft is no longer squawking an emergency code. This situation can generate confusion as to the actual status of the aircraft.

Executive control responsibility

The responsibility for control of the flight rests with the ATSU within whose airspace the aircraft is operating. However, if the pilot takes action contrary to a clearance that has already been coordinated with another sector or ATSU and further coordination is not possible in the time available, the responsibility for this action would rest with the pilot in command, and performed under the pilot's emergency authority.

Emergency procedures

The various circumstances surrounding each emergency situation preclude the establishment of exact detailed procedures to be followed. The procedures outlined in PANS-ATM Chapter 15 provide a general guide to air traffic services personnel and where necessary, should be adapted for the use of ADS-B.

10. SECURITY ISSUES ASSOCIATED WITH ADS-B

10.1 INTRODUCTION

ADS-B technologies are currently “open systems” and the openness is an essential component of successful use of ADS-B. It was also noted that ADS-B transmission from commercial aircraft is a “fact of life” today. Many commercial aircraft are already equipped with ADS-B and have been transmitting data for some time.

It was noted that there has been considerable alarmist publicity regarding ADS-B security. To a large extent, this publicity has not considered the nature and complexity of ATC. Careful assessment of security policies in use today for ADS-B and other technologies can provide a more balanced view.

10.2 CONSIDERATIONS

A list of ADS-B vulnerabilities categorised into threats to Confidentiality, Integrity and Availability has been reviewed and documented into the guidance material on security issues associated with ADS-B provided on the ICAO APAC website “<http://www.icao.int/APAC/Pages/edocs.aspx>” under “Restricted Site” for reference by States. States could contact ICAO Regional Office to get access to the guidance material. The following recommendations are made to States :

- (a) While ADS-B is recognized as a key enabling technology for aviation with potential safety benefits, it is recommended that States made aware of possible ADS-B security specific issues;
- (b) It is recommended that States note that much of the discussion of ADS-B issues in the Press has not considered the complete picture regarding the ATC use of surveillance data;
- (c) For current ADS-B technology implementation, security risk assessment studies should be made in coordination with appropriate national organisations and ANSPs to address appropriate mitigation applicable in each operational environment, in accordance with ATM interoperability requirements; and
- (d) Future development of ADS-B technology, as planned in the SESAR master plan for example, should address security issues. Studies should be made to identify potential encryption and authentication techniques, taking into consideration the operational need of air to ground and air to air surveillance applications. Distribution of encryption keys to a large number of ADS-B receivers is likely to be problematic and solutions in the near and medium term are not considered likely to be deployed worldwide. Internet based encryption strategies are not deployable when ground stations are pass receivers.

Commissioning Readiness		
The requirement for this form is specified in the System Management Manual (Section 11.2 of V4), C-MAN0107		
Project/Task Name	SAP Project/Task ID:	Sites or Locations affected:
Documentation prepared by:	Date:	Commissioning Date:
Affected System(s)	System Criticality	Change Consequence Level
Brief Description of Change:		

Commissioning Readiness Endorsement		
The endorsement of this form by the appropriate authorities as specified in the System Management Manual certifies that the requirements detailed in this form (with the exception of the non-critical deficiencies ¹ listed herein) have been completed prior to the commissioning of the system change or new system.		
Chief Engineer or Technical or Maintenance Authority		
Name:	Signature:	Date:
Designation:		
Chief Operating/User Authority or Operating/User Authority		
Name:	Signature:	Date:
Designation:		

Records Management Instructions
Place the completed Commissioning Readiness Form, together with any support documents on the Project file
Provide a copy of the completed Commissioning Readiness Form to P&E, Asset Lifecycle Manager, Planning and Integration

Note 1: Non-critical deficiencies (NCD) are those outstanding technical and operational issues that do not prevent the safe and effective use or maintenance of the facility, but will be addressed in a specified and agreed time. NCDs shall be listed on the Commissioning Certificate (C-FORMS0300) and recorded in the relevant system (ASID / HEAT / SAIR). It is preferable for each NCD to be recorded as a separate Issue.

**SYSTEM MANAGEMENT MANUAL
CHANGE CONTROL
C-FORMS0348**

Item No:	Requirement:	Requirement Reference: (Procedure/Instruction used to specified required input)	Completed or N/A	Evidence of Compliance (If a requirement is N/A, a reason why it is N/A is required to be entered)
1 OPERATIONAL SAFETY				
1.1	Provide a link to the completed SCARD SCARD Template (AA-TEMP-SAF-0042) Note: For unregulated systems the SCARD shall be used to assess the impact of the change and perform a preliminary hazard analysis	Safety Change Management Requirements AA-NOS-SAF-0104	Completed <input type="checkbox"/> N/A <input type="checkbox"/>	Link to SCARD
1.2	The outcome of the SCARD will be the requirement for one of the following for commissioning: Safety Statement – included in SCARD or standalone Safety Statement which must provide Airservices Australia management with sufficient information to demonstrate that safety has been considered and the change presents minimal or no safety issues. Safety Plan & Safety Assessment Report, or Safety Plan & Safety Case	Safety Change Management Requirements AA-NOS-SAF-0104 Document Search Database	Completed <input type="checkbox"/> N/A <input type="checkbox"/>	Link to Safety statement or Link to Safety Plan & Safety Assessment Report or Link to Safety Plan & Safety Case
1.3	Safety Plans, Safety Assessment Reports and Safety Cases are required to be available in the Document Search Database Safety risk management process completed and includes <ul style="list-style-type: none"> • any new hazards / impact to existing hazards identified? • controls identified and in place? and • residual risk justified and accepted. 	Safety Risk Management Procedures AA-PROC-SAF-0105	Completed <input type="checkbox"/> N/A <input type="checkbox"/>	
1.4	Impacts on the <u>Operational Risk Assessments</u> from residual risks have been assessed and implemented using Operational Risk Assessment Change Request and Acceptance Record – AA-FORM-SAF-0032	Operational Risk Assessment AA-NOS-SAF-0006 Safety Risk Management Procedures AA-PROC-SAF-0105	Completed <input type="checkbox"/> N/A <input type="checkbox"/>	Link to Operational Risk Assessment Change Request and Acceptance Record:
1.5	Arrangements for monitoring and review of risks are in place including arrangements for safety performance monitoring following the transition.	Safety Risk Management Procedures AA-PROC-SAF-0105	Completed <input type="checkbox"/> N/A <input type="checkbox"/>	
1.6	CASA have approved / accepted or been advised of the change, as applicable	Safety Change Management Requirements AA-NOS-SAF-0104	Completed <input type="checkbox"/> N/A <input type="checkbox"/>	

C-FORMS0348

Version 3: Effective 21 August 2012

Form approved by: Branch Manager, Operational Integrity & Compliance

Page 2 of 17

Commercial in Confidence

SYSTEM MANAGEMENT MANUAL
CHANGE CONTROL
C-FORMS0348

Item No:	Requirement:	Requirement Reference: (Procedure/Instruction used to specified required input)	Completed or N/A	Evidence of Compliance (If a requirement is N/A, a reason why it is N/A is required to be entered)
2 WORKPLACE HEALTH & SAFETY				
2.1	Initial WHS Hazard Identification must be completed as per the template AA-TEMP-SAF-0020	Safety Risk Management Procedures AA-PROC-SAF-0105 Initial WHS Hazard Identification AA-TEMP-SAF-0020 Workplace Health and Safety Risk Management Summary AA-TEMP-SAF-0016	Completed <input type="checkbox"/> N/A <input type="checkbox"/>	Link to completed Workplace Health and Safety Management Summary AA-TEMP-SAF-0016
2.2	Ensure employees and stakeholders are consulted when significant changes to work arrangements are being considered.	Working Together Workplace Consultation AA-PROC-SAF-0009	Completed <input type="checkbox"/> N/A <input type="checkbox"/>	
2.3	Tower Access / Classification assessed? Working at Heights Safety Checklist & Daily Toolbox Meeting (F098). Fall arrest facility / equipment available	Working at Heights PROC-157 Working at Heights Safety Checklist & Daily Toolbox Meeting F098	Completed <input type="checkbox"/> N/A <input type="checkbox"/>	
2.4	WHS hazard controls are in place - Safe Work Method Statement completed - Plant risks managed - Radhaz survey completed, published on the Avnet and general public & occupational exposure boundaries identified	Safe Work Method Statement AA-TEMP-SAF-0017 Managing WHS Risk for Contractors and Projects AA-PROC-SAF-0012 Plant Risk Management PROC-134 RF Radiation, Surveys & Health & Safety Mgmt PROC-121	Completed <input type="checkbox"/> N/A <input type="checkbox"/>	Link to completed Safe Work Method Statement AA-TEMP-SAF-0017 Link to completed F131 Plant Risk Management Checklist
2.5	At the completion of works ensure WHS Inspections are completed and hazard controls are in place. Building condition; clean, undamaged, all work completed.	Conducting Workplace Safety Inspections AA-PROC-SAF-0008	Completed <input type="checkbox"/> N/A <input type="checkbox"/>	

SYSTEM MANAGEMENT MANUAL
CHANGE CONTROL
C-FORMS0348

Item No:	Requirement:	Requirement Reference: (Procedure/Instruction used to specified required input)	Completed or N/A	Evidence of Compliance (If a requirement is N/A, a reason why it is N/A is required to be entered)
3 ENVIRONMENT				
3.1	Environmental Impact must be assessed using the Environmental Impact Screening & Assessment Criteria for Changes to On-ground Activities Assistance in assessing the Environmental Impact can be obtained from Environment and Climate Change Unit in Environment Group.	Environmental Screening & Assessment Criteria for Changes to On-ground Activities AA-REF-ENV-0010 Environmental Assessment of Changes to On-ground Activities. AA-NOS-ENV-2.200	Completed <input type="checkbox"/> N/A <input type="checkbox"/>	Link to completed Environmental Impact Screening and Assessment Form If a stage 2 assessment is required provide ARMS reference and links to any Permits, Master Development Plans and relevant correspondence as required.
3.2	Environmental Clearance obtained for ATM changes as per AA-NOS-ENV-2.100 Assistance in assessing the Environmental Impact can be obtained from Environment and Climate Change Unit in Environment Group.	Environment Assessment Process for ATM Changes AA-NOS-ENV-2.100	Completed <input type="checkbox"/> N/A <input type="checkbox"/>	Provide ARMS reference and NRFC reference if ATM change required
4 PEOPLE- SUPPORT				
ATC TRAINING				
4.1	ATC Training Needs Analysis completed and Training Plan developed?		Completed <input type="checkbox"/> N/A <input type="checkbox"/>	Link to Training Needs Analysis and Training Plan
4.2	Sufficient number of trained, rated and endorsed ATC staff available.		Completed <input type="checkbox"/> N/A <input type="checkbox"/>	Number Trained:
4.3	ATC staff individual training records in SAP database have been updated		Completed <input type="checkbox"/> N/A <input type="checkbox"/>	
4.4	Plans are in place to complete any outstanding training, rating, and endorsement of remaining ATC staff (Normally an identified hazard)		Completed <input type="checkbox"/> N/A <input type="checkbox"/>	HAZLOG Register No:

SYSTEM MANAGEMENT MANUAL
CHANGE CONTROL
C-FORMS0348

Item No:	Requirement:	Requirement Reference: (Procedure/Instruction used to specified required input)	Completed or N/A	Evidence of Compliance (If a requirement is N/A, a reason why it is N/A is required to be entered)
TECHNICAL TRAINING				
4.5	Training Needs Analysis completed and Training Plan developed for system support staff and field maintenance staff?		Completed <input type="checkbox"/> N/A <input type="checkbox"/>	Link to Training Needs Analysis and Training Plan
4.6	TechCert codes have been created, assessment criteria developed or existing assessment criteria has been amended	TechCert codes TechCert Guides and Forms	Completed <input type="checkbox"/> N/A <input type="checkbox"/>	Link to TechCert Guides and Forms
4.7	Sufficient system support staff and field maintenance staff appropriately trained?		Completed <input type="checkbox"/> N/A <input type="checkbox"/>	
4.8	Are plans in place to complete any outstanding training and certification of system support staff and remaining field maintenance staff?		Completed <input type="checkbox"/> N/A <input type="checkbox"/>	
4.9	Field maintenance staff hold the relevant TechCert to perform duties.	Technical Certification PROC-141	Completed <input type="checkbox"/> N/A <input type="checkbox"/>	
4.10	Statutory / special licensing obtained by field maintenance staff including high risk work competencies and licensing requirements?		Completed <input type="checkbox"/> N/A <input type="checkbox"/>	
4.11	ABS and FMS staff training details sent to Technical Training Coordinator and training records updated as required?	Training PROC-119	Completed <input type="checkbox"/> N/A <input type="checkbox"/>	
4.12	TechCert details sent to FMS System Support to update the Qualifications (TechCert) Database	Technical Certification PROC-141	Completed <input type="checkbox"/> N/A <input type="checkbox"/>	
LOGISTICAL SUPPORT				
4.13	CMRD have been consulted regarding special test equipment, test beds, etc		Completed <input type="checkbox"/> N/A <input type="checkbox"/>	

SYSTEM MANAGEMENT MANUAL
CHANGE CONTROL
C-FORMS0348

Item No:	Requirement:	Requirement Reference: (Procedure/instruction used to specified required input)	Completed or N/A	Evidence of Compliance (If a requirement is N/A, a reason why it is N/A is required to be entered)
4.14	CMRD / NDC have been consulted regarding spares holdings and repair of LRUs from this equipment or in-house support of Depot Level Support Contract / repair contract		Completed <input type="checkbox"/> N/A <input type="checkbox"/>	
4.15	TEMACC advised of any specialised test equipment requirements.	Test Equipment Management PROC-150	Completed <input type="checkbox"/> N/A <input type="checkbox"/>	
4.16	Maintenance support contracts in place (external and/or internal)? – Appropriate vendor and/or internal support? – Appropriate Level 3 maintenance arrangements		Completed <input type="checkbox"/> N/A <input type="checkbox"/>	
4.17	Test equipment provided to maintenance base. Note: Test equipment purchasing and calibration requirements detailed in Engineering Execution Readiness form.		Completed <input type="checkbox"/> N/A <input type="checkbox"/>	
4.18	Specialised hardware or software system support and field maintenance tools, test / patch leads, adaptors, isolators, electronic discharge protection (mats, straps), etc supplied?		Completed <input type="checkbox"/> N/A <input type="checkbox"/>	
4.19	System Business Continuity/ Disaster Recovery provisions supplied/updated?		Completed <input type="checkbox"/> N/A <input type="checkbox"/>	
4.20	Spares – Supplied, storage correct, transport cases supplied?	Management of Goods & Supplies PROC-118	Completed <input type="checkbox"/> N/A <input type="checkbox"/>	
4.21	Spares – Software / firmware loaded, tested & configured?		Completed <input type="checkbox"/> N/A <input type="checkbox"/>	
4.22	Service Restoration Times (SRT) established?	Airways Service Data PROC-207	Completed <input type="checkbox"/> N/A <input type="checkbox"/>	

SYSTEM MANAGEMENT MANUAL
CHANGE CONTROL
C-FORMS0348

Item No:	Requirement:	Requirement Reference: (Procedure/Instruction used to specified required input)	Completed or N/A	Evidence of Compliance (If a requirement is N/A, a reason why it is N/A is required to be entered)
4.23	Conduct Hardware physical configuration audit and ensure SAP Plant Maintenance has updated information of all installed and/or demolished equipment (including monitoring circuits) and sent to System Operations SAP PM DATA CHANGES .	Equipment Installed/Demolished Advice SAP Data Input Form F104	Completed <input type="checkbox"/> N/A <input type="checkbox"/>	Link to Email from SAP PM Support confirming updates
5 PROCEDURES				
ATC DOCUMENTATION				
5.1	System Requirements documentation including Operating Concept or Business Process Rules - produced/updated and approved?		Completed <input type="checkbox"/> N/A <input type="checkbox"/>	Link to documentation
5.2	Manual of Air Traffic Services (MATS) reviewed / updated. Aeronautical information publications (AIP Book, AIP SUPP, AIC, DAP, ERSA, Charts, etc) reviewed / updated. Amendment times are determined by the AIS Distribution Schedule	AA Publications AIS Distribution Schedule	Completed <input type="checkbox"/> N/A <input type="checkbox"/>	NRFC No.
5.3	National ATC Procedures Manual (NAPM) and any other relevant ATC procedures reviewed / updated.		Completed <input type="checkbox"/> N/A <input type="checkbox"/>	NRFC No.
5.4	ATC contingency / continuity plans reviewed / updated.	ATS Contingency Plans Business Continuity Plans C-BCP	Completed <input type="checkbox"/> N/A <input type="checkbox"/>	ATS-CP No: C-BCP No:
5.5	NOTAM and/or AIP SUP issued / amended / cancelled	Works Planning PROC-213 Refer also LOA3024	Completed <input type="checkbox"/> N/A <input type="checkbox"/>	NOTAM No:
5.6	ATC Temporary Local Instruction (TLI) issued notifying Operational staff of change?	Temporary Local Instructions & Database	Completed <input type="checkbox"/> N/A <input type="checkbox"/>	NRFC No.

**SYSTEM MANAGEMENT MANUAL
CHANGE CONTROL
C-FORMS0348**

Item No:	Requirement:	Requirement Reference: <small>(Procedure/Instruction used to specified required input)</small>	Completed or N/A	Evidence of Compliance <small>(If a requirement is N/A, a reason why it is N/A is required to be entered)</small>
USER DOCUMENTATION				
5.7	User/operator manuals updated		Completed <input type="checkbox"/> N/A <input type="checkbox"/>	
5.8	User/operator procedures provided/updated as applicable		Completed <input type="checkbox"/> N/A <input type="checkbox"/>	
5.9	On-line user/operator documentation completed and published		Completed <input type="checkbox"/> N/A <input type="checkbox"/>	
5.10	ARFF instructions updated		Completed <input type="checkbox"/> N/A <input type="checkbox"/>	
5.11	Other Business Groups instructions updated?		Completed <input type="checkbox"/> N/A <input type="checkbox"/>	
TECHNICAL DOCUMENTATION				
5.12	Software design documents updated, adequate and supplied to system support?		Completed <input type="checkbox"/> N/A <input type="checkbox"/>	
5.13	Software and/or dataset Version or Release Description Documentation supplied and adequate?		Completed <input type="checkbox"/> N/A <input type="checkbox"/>	Link to Version Description Document or Release Description Document
5.14	Software installation procedure and instructions supplied/updated and adequate?		Completed <input type="checkbox"/> N/A <input type="checkbox"/>	Link to Installation Procedure

SYSTEM MANAGEMENT MANUAL
CHANGE CONTROL
C-FORMS0348

Item No:	Requirement:	Requirement Reference: (Procedure/Instruction used to specified required input)	Completed or N/A	Evidence of Compliance (If a requirement is N/A, a reason why it is N/A is required to be entered)
5.15	SMP: System Management Plan created / updated and adequate?	SMP Template	Completed <input type="checkbox"/> N/A <input type="checkbox"/>	SMP No:
5.16	SCP: System Contingency / continuity plans supplied/updated and adequate?	SCP Template	Completed <input type="checkbox"/> N/A <input type="checkbox"/>	SCP No:
5.17	Technical drawings updated and listed in Data Viewer and list supplied to system supporters and field maintenance staff.	Technical Drawing Management PROC-178	Completed <input type="checkbox"/> N/A <input type="checkbox"/>	
5.18	Technical handbooks/manuals supplied to ABS or FMS Engineering/IT support and field maintenance staff (base and site copy).	Document Management PROC-103	Completed <input type="checkbox"/> N/A <input type="checkbox"/>	
5.19	On-line system support and field maintenance documentation completed and published		Completed <input type="checkbox"/> N/A <input type="checkbox"/>	
5.20	Technical documentation registered and placed under documentation control	Document Management PROC-103	Completed <input type="checkbox"/> N/A <input type="checkbox"/>	
5.21	Appropriate engineering performance requirements specified and issued for ongoing use? System Specification documentation supplied/updated and adequate?	System Performance Requirements & Reporting Specification ASYS-106	Completed <input type="checkbox"/> N/A <input type="checkbox"/>	
5.22	Configuration & Modification AEI: Equipment and System Modifications and Configuration (for hardware and software), and Software Release Authorisations are documented in a Part 2 AEI (or other approved documentation)	Development of Maintenance Instructions for Equipment PROC-151	Completed <input type="checkbox"/> N/A <input type="checkbox"/>	AEI No/s: Link to documentation detailing configuration and modification
5.23	Maintenance AEI: Maintenance requirements, including Performance Inspection tolerances, have been defined and documented in AEIs (or other approved documentation). (AEI Part 3.4.7)	Development of Maintenance Instructions for Equipment PROC-151	Completed <input type="checkbox"/> N/A <input type="checkbox"/>	AEI No/s:

SYSTEM MANAGEMENT MANUAL
CHANGE CONTROL
C-FORMS0348

Item No:	Requirement:	Requirement Reference: <small>(Procedure/Instruction used to specified required input)</small>	Completed or N/A	Evidence of Compliance <small>(If a requirement is N/A, a reason why it is N/A is required to be entered)</small>
5.24	AEI: New maintenance AEIs trialled by maintenance staff	Development of Maintenance Instructions for Equipment PROC-151	Completed <input type="checkbox"/> N/A <input type="checkbox"/>	
5.25	TTD: Temporary Technical Dispensation raised and published on the Document Search database.	Temporary Technical Dispensations PROC-153	Completed <input type="checkbox"/> N/A <input type="checkbox"/>	TTD No:
5.26	Site Manifest updated	Site Manifests FMS-304	Completed <input type="checkbox"/> N/A <input type="checkbox"/>	
6 SYSTEM				
DESIGN REQUIREMENTS				
6.1	System Requirements documentation including Operating Concept or Business Process Rules - supplied/updated and approved?	Design Control PROC-146	Completed <input type="checkbox"/> N/A <input type="checkbox"/>	Links to documentation
6.2	Standards – Installation and equipment comply with all relevant Australian Standards? Building Codes - Structures comply with the relevant Building Codes? The relevant Australian Standards and Building Codes are to be determined by the Chief Engineer, Technical Authority or Maintenance Authority	Australian Standards Design Control PROC-146	Completed <input type="checkbox"/> N/A <input type="checkbox"/>	
6.3	Other applicable Federal and/or State licensing requirements met? The relevant licensing requirements are to be determined by the Chief Engineer, Technical Authority or Maintenance Authority	Design Control PROC-146	Completed <input type="checkbox"/> N/A <input type="checkbox"/>	

**SYSTEM MANAGEMENT MANUAL
CHANGE CONTROL
C-FORMS0348**

Item No:	Requirement:	Requirement Reference: <small>(Procedure/Instruction used to specified required input)</small>	Completed or N/A	Evidence of Compliance <small>(If a requirement is N/A, a reason why it is N/A is required to be entered)</small>
6.4	Electrical Mechanical, Structure and Building impacts have been assessed as adequate or modifications organised and completed through consultation with Engineering Branch, P&E? (Power supply capability / airconditioning capacity / mast loadings)	Design Control PROC-146	Completed <input type="checkbox"/> N/A <input type="checkbox"/>	
6.5	Earthing and Lightning Protection meets Airservices requirements?	Earthing and Lightning Protection Systems for Operational Facilities AEI 3.1504 Site Earthing and Lightning Protection Systems for Existing Installations AEI 2.3011	Completed <input type="checkbox"/> N/A <input type="checkbox"/>	
6.6	Battery Procurement as per Airservices requirements?	Lead Acid Batteries (Stationary) Procurement and Acceptance Testing AEI-3.7050 Panel Contract Arrangement C-PROC0140	Completed <input type="checkbox"/> N/A <input type="checkbox"/>	
6.7	Assessing the impact of information systems against corporate objectives (7 Ticks process).	Information Technology Application Certification – 7 Ticks MI-0804 and PROC-190	Completed <input type="checkbox"/> N/A <input type="checkbox"/>	Link to completed 7 Ticks Interim Certificate or Final Certificate
6.8	IT Security measures appropriate and in place (ie. to ensure effective security and control practices to minimise the risks of unauthorised access, inappropriate use, modification, destruction or disclosure of electronically held data).	IT Security Roles and Responsibilities Statement MS-0013 Information Security MI-0808 ICT Resources – Conditions of Use MI-0829	Completed <input type="checkbox"/> N/A <input type="checkbox"/>	

Item No:	Requirement:	Requirement Reference: <small>(Procedure/Instruction used to specified required input)</small>	Completed or N/A	Evidence of Compliance <small>(If a requirement is N/A, a reason why it is N/A is required to be entered)</small>
6.9	Information Security	Information Security C-PROC0184	Completed <input type="checkbox"/> N/A <input type="checkbox"/>	Link to completed security risk management plan
INSTALLATION REQUIREMENTS				
6.10	Has met the regulation and safety requirements for Telecommunications Installations. Cable Markers installed (external)? Equipment complies with ACMA statutory requirement Telecommunication Labelling (Customer Equipment and Customer Cabling) Notice 2001 as amended (i.e. 'A' ticked on the equipment compliance plate)	Implementing Regulation and Safety Requirements for Telecommunications Installations PROC-138 Installation of Optical Fibre Cable - Underground AEI 4.5001 Underground Cable Marking AEI 4.3001	Completed <input type="checkbox"/> N/A <input type="checkbox"/>	Link to Telecommunications Cabling Advice
6.11	MDF/IDF Records created / updated? Labelling/Colour Coding – Rack, Cable, Chassis, etc.?	Colour Coding of RJ45 Patch Leads for Voice and Data Installations AEI 7.3241	Completed <input type="checkbox"/> N/A <input type="checkbox"/>	
6.12	Transmitters licence label affixed	Radio Communication Transmitter Labelling AEI 7.4238	Completed <input type="checkbox"/> N/A <input type="checkbox"/>	
6.13	Electrical Certificate of Testing and Safety or Testing and Compliance on connection to a source of electricity (i.e. installation conforms to AS3000) are required to be supplied as soon as possible after connection or testing of any electrical installation or change. Labelling – Switch Boards, etc Meets Airservices Electrical Cable Colour Coding requirements?	Electrical Safety Regulation 2002 Sections 15 and 159 AS 3000 – Aust Standard Electrical Cable Colour Coding AEI 3.1502	Completed <input type="checkbox"/> N/A <input type="checkbox"/>	Links to Electrical Certificates

**SYSTEM MANAGEMENT MANUAL
CHANGE CONTROL
C-FORMS0348**

Item No:	Requirement:	Requirement Reference: <small>(Procedure/Instruction used to specified required input)</small>	Completed or N/A	Evidence of Compliance <small>(If a requirement is N/A, a reason why it is N/A is required to be entered)</small>
6.14	All modifications complete and scratch plate labels affixed to equipments	Identification of Airways Systems Equipment Hardware Modifications PROC-154	Completed <input type="checkbox"/> N/A <input type="checkbox"/>	
6.15	Integration with National Technical Monitoring has been organised and completed through Engineering Branch, P&E?		Completed <input type="checkbox"/> N/A <input type="checkbox"/>	
6.16	Alarm monitoring installed and tested at TOC for local and remote site?		Completed <input type="checkbox"/> N/A <input type="checkbox"/>	
6.17	Source media – supplied/backed up, stored, registered with system support?	Software Media Archival and Storage PROC-147	Completed <input type="checkbox"/> N/A <input type="checkbox"/>	
6.18	Site installable media – supplied/backed up, appropriately stored and registered by field maintainers?	Software Media Archival and Storage PROC-147	Completed <input type="checkbox"/> N/A <input type="checkbox"/>	
6.19	Software licences provided, registered and appropriately stored? <small>(Including details of any third party licensing)</small>		Completed <input type="checkbox"/> N/A <input type="checkbox"/>	
6.20	Update HEAT and/or ASID database to incorporate new system/version number and assign issue management roles?		Completed <input type="checkbox"/> N/A <input type="checkbox"/>	

SYSTEM MANAGEMENT MANUAL
CHANGE CONTROL
C-FORMS0348

Item No:	Requirement:	Requirement Reference: (Procedure/Instruction used to specified required input)	Completed or N/A	Evidence of Compliance (If a requirement is N/A, a reason why it is N/A is required to be entered)
DESIGN CONFIRMATION				
6.21	<p>Airservices Physical Security requirements met.</p> <p>The minimum security requirements are specified in C-GUIDE0157. Physical Security advise can be obtained from the relevant Security Advisor in Security and Crisis Planning, Safety & Environment</p> <p>Physical Access requirements are determined and established</p> <p>Siting and accommodation impact has been assessed as being satisfactory or modifications organised through National Property?</p>	<p>Physical Security – Critical Operational Facilities C-GUIDE0157</p> <p>Site Management PROC-170</p>	<p>Completed <input type="checkbox"/></p> <p>N/A <input type="checkbox"/></p>	
6.22	<p>Network data load impact has been assessed as being satisfactory or modifications organised and completed through Engineering Branch, P&E?</p>		<p>Completed <input type="checkbox"/></p> <p>N/A <input type="checkbox"/></p>	
6.23	<p>Spectrum licences (either cancelled if no longer required or for new licenses including if antenna moves by more than 10 metres)</p>	<p>Frequency Management: Obtaining a Frequency Assignment and Licence AEI-7.4202</p>	<p>Completed <input type="checkbox"/></p> <p>N/A <input type="checkbox"/></p>	
6.24	<p>New system or system change acceptance tests (software and/or hardware) satisfactorily completed against the approved system requirements?</p> <ul style="list-style-type: none"> - Test Plans provided? - FAT, SAT, UAT test results complete, passed to the required level and provided? - Test identified defect listings and re-test information provided? 	<p>System Management Manual SMMI</p> <p>Design Control PROC-146</p>	<p>Completed <input type="checkbox"/></p> <p>N/A <input type="checkbox"/></p>	
6.25	<p>Battery Acceptance Tests as per Airservices requirements?</p>	<p>Lead Acid Batteries (Stationary) Procurement and Acceptance Testing AEI-3.7050</p>	<p>Completed <input type="checkbox"/></p> <p>N/A <input type="checkbox"/></p>	<p>Link to Battery Acceptance Test Results</p>

**SYSTEM MANAGEMENT MANUAL
CHANGE CONTROL
C-FORMS0348**

Item No:	Requirement:	Requirement Reference: (Procedure/Instruction used to specified required input)	Completed or N/A	Evidence of Compliance (If a requirement is N/A, a reason why it is N/A is required to be entered)
6.26	Standard Operating Conditions (SOCs) / Site Configuration Data (SCD) established / approved	Standard Operating Conditions & Site Configuration Data Management PROC-143	Completed <input type="checkbox"/> N/A <input type="checkbox"/>	
6.27	Flight Test results supplied and satisfactory	Certification of Radio Navigation Aid Facilities AEI 7.4003	Completed <input type="checkbox"/> N/A <input type="checkbox"/>	
6.28	Equipment operation is as per AEI specifications and any additionally specified requirements? Relevant requirements and performance specifications to be determined by the Chief Engineer, Technical Authority or Maintenance Authority		Completed <input type="checkbox"/> N/A <input type="checkbox"/>	
7 TRANSITION				
PLANNING				
7.1	Does the system meet all critical user and technical requirements?		Completed <input type="checkbox"/> N/A <input type="checkbox"/>	
7.2	If non-critical deficiencies are proposed to be accepted into operation, are they managed and tracked via ASID, HEAT or SAIR, including responsibilities and timings and attached to the Commissioning Certificate?		Completed <input type="checkbox"/> N/A <input type="checkbox"/>	
7.3	Cutover Plan prepared and authorised by: – Appropriate level of engineering authority? – Appropriate level of User Authority?	Cutover Plan C-TEMP0045	Completed <input type="checkbox"/> N/A <input type="checkbox"/>	Link to Cutover Plan
7.4	Works plan created at least 7 days before deployment	Works Planning PROC-213	Completed <input type="checkbox"/> N/A <input type="checkbox"/>	Works Plan No.

SYSTEM MANAGEMENT MANUAL
CHANGE CONTROL
C-FORMS0348

Item No:	Requirement:	Requirement Reference: (Procedure/Instruction used to specified required input)	Completed or N/A	Evidence of Compliance (If a requirement is N/A, a reason why it is N/A is required to be entered)
NOTIFICATION				
7.5	Industry education / notification been completed?		Completed <input type="checkbox"/> N/A <input type="checkbox"/>	
7.6	Relevant Business Managers advised of impending change?		Completed <input type="checkbox"/> N/A <input type="checkbox"/>	
7.7	Change requester and/or sponsor notified?		Completed <input type="checkbox"/> N/A <input type="checkbox"/>	
7.8	System Operations' TOC and Service Desk notified and accepted operating responsibility for the change.		Completed <input type="checkbox"/> N/A <input type="checkbox"/>	
7.9	ABS/FMS Manager has accepted maintenance responsibility		Completed <input type="checkbox"/> N/A <input type="checkbox"/>	
7.10	Notify the following (as appropriate) that the system is at "OPERATIONAL READINESS" and provide details of commissioning and any system changes: ATC System Supervisor, Melbourne (ATC) System Supervisor, Brisbane (ATC) National ATC Systems Manager Operating Authority (relevant)	Sys to Svc List	Completed <input type="checkbox"/> N/A <input type="checkbox"/>	

SYSTEM MANAGEMENT MANUAL
CHANGE CONTROL
C-FORMS0348

Item No:	Requirement:	Requirement Reference: (Procedure/Instruction used to specified required input)	Completed or N/A	Evidence of Compliance (If a requirement is N/A, a reason why it is N/A is required to be entered)
7.11	Notify the following (as appropriate) that the system is at "ENGINEERING READINESS" and provide details of commissioning and any system changes: P&E Technical Authority (relevant) Technical Operations Centre – Director Service Desk –Airways SAP PM Support	Sys to Svc List	Completed <input type="checkbox"/> N/A <input type="checkbox"/>	



COMMISSIONING CERTIFICATE		
The requirement for this form is specified in the System Management Manual (Section 11.2 of V4), C-MAN0107		
Project/Task Name	SAP Project/Task ID:	Sites or Locations affected:
Documentation prepared by:	Date:	Commissioning Date:
Affected System(s)	System Criticality	Change Consequence Level
Brief Description of Change:		

Commissioning Approval		
<p>The approval of this document by the appropriate authorities as specified in the System Management Manual certifies that the new system or system change is satisfactory to meet the specified service and performance requirements; that system operating and support requirements are in place; that required user and technical training is adequately provisioned; as detailed in the Commissioning Readiness Form and consequently the new system or system change is declared fit-for-purpose and can be deployed and operated until formally decommissioned or otherwise revoked.</p> <p>This approval is provided subject to the non-critical deficiencies¹ listed herein.</p>		
Chief Engineer, Technical or Maintenance Authority		
Name	Signature:	Date
Designation:		
Chief Operating/User Authority or Operating/User Authority		
Name:	Signature:	Date:
Designation:		

Records Management Instructions
Place the completed Commissioning Certificate, together with the completed Commissioning Readiness form on the Project file
Provide a copy of the completed Commissioning Certificate, and the completed Commissioning Readiness Form to P&E, Asset Lifecycle Manager, Planning and Integration

Note 1: Non-critical deficiencies are those outstanding technical and operational issues that do not prevent the safe and effective use of the facility by users or prevent effective technical maintenance, but will be addressed in a specified and agreed time.



**SYSTEM MANAGEMENT MANUAL
CHANGE CONTROL
C-FORMS0300**

LIST OF NON-CRITICAL DEFICIENCIES WAIVED AT TIME OF COMMISSIONING Either list non-critical deficiencies here or attach a list if space insufficient				
Issue	Issue Tracking Reference Number	Allocated to	Proposed Completion Date	Comments

**Guidance Materials on Monitoring and Analysis
of ADS-B Avionics Performance**

1 Introduction

- 1.1 The APANPIRG has endorsed the following Conclusion during its 24th Meeting to encourage States/Administration to exchange their ADS-B performance monitoring results and experience gained from the process :

Conclusion 24/45 - Exchange ADS-B Performance Monitoring Result

“That, States be encouraged to exchange findings/result of their ADS-B performance monitoring including experience gained in conducting the required performance monitoring.”

- 1.2 Since the ADS-B mandate for some airspace in the Region became effective in December 2013, monitoring and analysis on avionics performance of ADS-B equipped aircraft has become an increasingly important task for concerned States. The fully functional ADS-B Avionics Problem Reporting Database (APRD) was launched on the 21 July 2017. The database is placed at ICAO APAC website in the restricted area with name: APAC ADS-B Avionics Problem Reporting Database accessible via <https://applications.icao.int/ADSB-APRD/login.aspx>. States are encouraged to make full use of the APRD for reporting ADS-B avionics problems and sharing experience as well as follow-up actions through the APRD web-page.
- 1.3 This document serves to provide guidance materials on monitoring and analysis of avionics performance of ADS-B equipped aircraft, which is based on the experience gained by States.

2 Problem Reporting and Feedback

- 2.1 For ADS-B avionics problems, it is critical that an appropriate reporting and feedback mechanism be established. It is highly desirable that those discovering the problems should report them to the appropriate parties to take action, such as study and analyse the problems, identify the root causes, and rectify them. Those action parties include :-
- (a) Air Navigation Service Providers (ANSPs) – upon detection of any unacceptable ADS-B reports from an aircraft, report the observed problem to the performance monitoring agent(s), if any, and the Aircraft Operators for investigation. In addition, ANSPs should take all actions to avoid using the ADS-B reports from the aircraft

- until the problem is rectified (e.g. black listing the aircraft), if usage of such reports could compromise safety.
- (b) Regulators – to initiate any appropriate regulatory action or enforcement.
 - (c) Aircraft Operators – to allow avionics specialists to examine the causes and as customers of the avionics manufacturers ensure that corrective action will take place.
 - (d) Avionics Manufacturers and Aircraft Manufacturers – to provide technical evidence and knowledge about the problem and problem rectification
- 2.2 Incentives should be received by those parties acting on the problems including :-
- (a) Regulations that require deficiencies to be rectified
 - (b) Regulatory enforcement
 - (c) Consequences if conduct of operations with problematic equipment (e.g. no access to the airspace requiring healthy equipment)
- 2.3 When an ADS-B avionics problem is reported, it should come along with adequate details about the problem nature to the action parties. In addition, the problem should be properly categorised, so that appropriate parties could diagnose and rectify them systematically.

3 Problem Categorisation

- 3.1 Regarding ADS-B avionics, their problems are quite diversified in the Region but can be categorized to ensure they will be examined and tackled systematically.
- 3.2 Based on the experience gained from States, the common ADS-B avionics problems in the Region are summarized under different categories in Attachment A. It is noted that only a relatively minor portion of the aircraft population exhibits these problems. It must be emphasized that aircraft transmitting incorrect positional data with NUC = 0 or NIC = 0 should not be considered a safety problem. The data transmitted have no integrity and shall not be used by ATC. This situation exists for many aircraft when their GNSS receivers are not connected to the transponders.

4 Managing the Problem

- 4.1 There are two major approaches to manage the problems :-
- (a) Regulatory approach
Regulations which require non-approved avionics to disable ADS-B transmission (or transmit “no integrity”), and the concerned operators to file flight plans to indicate no ADS-B equipage. APANPIRG has endorsed this approach which is reflected in the Regional Supplementary Procedures (Doc 7030).

(b) Blacklist approach

Filtering out (“black listing”) any airframes that do not comply with the regulations or transmitting bad data, and advising the regulator of the non-compliance. This approach is temporary which allows the ANSP to protect the system whilst regulatory action is underway.

While deciding on whether an aircraft transmitting erroneous ADS-B data should be added into the blacklist, the following factors will be critically assessed:

- i. Impact and risk to ATC operational safety
Use of erroneous ADS-B data to maintain separation may potentially contribute to loss of separation or ATC coordination error.
- ii. Frequency of erroneous position
Whether it is occasional or frequently broadcast of erroneous position.
- iii. Amount of deviation
This can be a track jumping problem which is of significant safety impact to ATC or just an occasional small position jump which is not detectable in ATC with insignificant impact.
- iv. Others
Such as the ICAO aircraft address received from ADS-B being inconsistent with the aircraft registration, Flight ID entered via cockpit interface mismatched with aircraft callsign in the Flight Plan, etc.

After deciding to put an aircraft into the blacklist list, the following procedures will be carried out:

- i. Informing the concerned aircraft operator/regulatory authority
The concerned aircraft operator/regulatory authority will be notified of the decision and the rationale before putting the aircraft into the exclusion list.
- ii. Pre-processing of flight plan concerned
As the blacklist mechanism involves filtering out the ADS-B data of the subject aircraft, from operational perspective, air traffic controllers need to be aware in advance that the concerned aircraft plans to operate in their FIR. A flight plan pre-processing system may locate the flight plan by checking against the 24-bit address or aircraft registration in the blacklist, and issue an alert to the air traffic controllers if appropriate, such as automatically insert a remark in the Item 18 of the concerned flight plan before feeding the flight plan into the ATC Automation System, and the ATC Automation System may issue an alert to the air traffic controllers with a specific label annotated in the corresponding electronic flight strips.
- iii. Coordinate with adjacent Area Control Centre (ACC)

Upon posting of pending inbound flights with corresponding electronic flight strips indicating non-ADS-B equipage or in the blacklist, the air traffic controllers shall inform the upstream ACC that transfer of that particular flight will not be accepted at the ADS-B exclusive airspace. It is important to carry out this coordination action as early as possible as the upstream sector may have difficulty to adjust the flight route at the transfer stage.

- iv. Handling of an aircraft for removal from the blacklist once rectification action had taken place

Once notification from the aircraft operators/regulatory authorities is received that the problem has been rectified, performance of the aircraft will be closely monitored when it flies to the concerned FIR. If the aircraft shows the observed problem has been resolved, the aircraft will be removed from the blacklist. The aircraft operator/regulatory authority will also be notified accordingly.

5 Systematic Monitoring and Analysis of the Problem

States using ADS-B should have in place systematic ways to identify and manage ADS-B deficiencies similar to that described below :-

5.1 Reporting Deficiencies

States using ADS-B should have in place systematic ways to identify ADS-B deficiencies including :-

- (a) Systematic capture of ATC reported events and engineering detected events into a database; and
- (b) Manual or automatic detection of anomalous avionics behavior independent from controller reports

5.1.1 ATC Reported Deficiencies

ATC procedures should exist that allow services to continue to be provided safety, as well as to capture relevant information for later analysis. This should include :-

- (a) ATC request for the pilot to select the alternate transponder; and
- (b) ATC to adequately record the circumstances including Flight ID, ICAO Aircraft Address (if readily available) accurate time, Flight plan, and pilot provided information.

5.1.2 Non ATC reported deficiencies

5.1.2.1 Where capability is available, States should also identify non ATC reported deficiencies.

5.1.2.2 Without overlapping radar coverage: ADS-B data may be examined for the following :-

- (a) NUCp of each ADS-B reported position is smaller than required for service delivery for more than 5% of total number of ADS-B updates;
- (b) NIC, NACp, SIL are smaller than required for service delivery for more than 5% of total number of ADS-B updates;
- (c) ICAO Aircraft Address (i.e. I021/080) is inconsistent with the flight planned registration (REG) based on each state's ICAO Aircraft Address allocation methodology;
- (d) Flight ID entered via cockpit interface and downlinked in ADS-B data (i.e. I021/170 in Asterix CAT 21) is a mismatch¹ with aircraft callsign in the ATS Flight Plan;
- (e) Inconsistent vertical rate compared to flight level change; and
- (f) Inconsistency of position reports and presence of "jumps."

5.1.2.3 Overlapping radar coverage: For States that have overlapping radar coverage, a systematic means to monitor and analyze ADS-B could be considered in addition to relying on ATC to report the problem, or utilising the evaluation criteria in 5.1.2.2 above. This can be achieved by comparing radar information with ADS-B reported position, velocity, flight level and vertical rate change data as well as examining the ADS-B quality indicators and Flight Identification (FLTID) contained in the ADS-B reports.

For each ADS-B flight, its ADS-B data could be compared with its corresponding radar information. For example, this would allow analysis to determine if the following pre-defined criteria are met :-

- (a) Deviation between ADS-B reported position and independent referenced radar position is greater than 1NM², with the indication of good positional quality in the quality indicators for more than 5% of total number ADS-B updates. A sample screen

¹ A missing Flight ID, or a Flight ID with only "spaces" should not be considered a mismatch.

² For example, the deviation between ADS-B and radar tracks could be set to 1NM in accordance with ICAO Circular 326 defining position integrity ($0.5\text{NM} < \text{HPL} < 1\text{NM}$) for 3NM aircraft separation use, on assumption that radar targets are close to actual aircraft position. The values of ADS-B quality indicators (NUCp, NACp, SIL, NIC) could be chosen based on the definition in ICAO Circular 326 on Position Accuracy and Position Integrity for 3NM aircraft separation minimum. A threshold of 5% is initially set to exclude aircraft only exhibiting occasional problems during their flight journey. The above criteria should be made configurable to allow fine-tuning in future. Evaluation of ADS-B vs radar may alternatively expose radar calibration issues requiring further investigation.

shot of a system performing the analysis automatically is given at Attachment B for reference.

5.2 Managing and Processing Deficiencies

Whether detected by ATC or not, all deficiencies should trigger:

- (a) Systematic recording of the details of each occurrence such as date/time of occurrence, ICAO aircraft address and flight plan information should be obtained. Graphical representations such as screen capture of radar and ADS-B history tracks, graphs of NUCp/NIC value changes versus time and deviation between radar and ADS-B tracks along the flight journey would be desirable. Examples of typical graphical representations are shown below :-

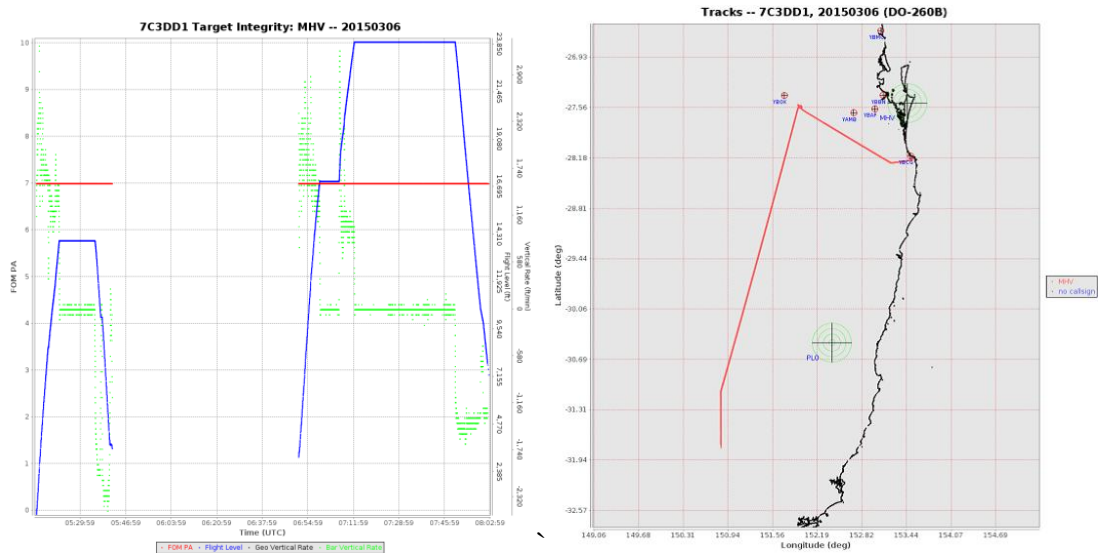

- (b) Systematic technical analysis of each detected issue using ADS-B recorded data, to ensure that all detected issues are examined and addressed. Typically this will need:
 - systems to record ADS-B data, replay ADS-B data and analyze ADS-B data
 - staff and procedures to analyze each report
 - A database system to manage the status of each event and to store the results of each analysis
- (c) Procedures to support engagement with operators (domestic & foreign), regulators, other ANSPs, Airframe OEMs and avionics vendors to ensure that each issue is

investigated adequately and maximize the probability that the root cause of the event is determined. The procedures could include :-

- Data collection procedures;
- Telephone & email contact details; and
- Mechanisms for reporting, as appropriate, to the Asia Pacific ADS-B Avionics Problem Reporting Database (APRD)

* * * * *

Attachment A – List of known ADS-B avionics problems

Ref.	Problem	Cause	Safety Implications to ATC (Yes / No)	Recommendations
1.	Track Jumping problem with Rockwell Collins TPR901 (See Figure1)	<p>Software issue with TPR901 transponder initially only affecting Boeing aircraft. Does not occur in all aircraft with this transponder.</p> <p>Subsequent investigation by Rockwell Collins has found that the particular transponder, common to all of the aircraft where the position jumps had been observed, had an issue when crossing ± 180 degrees longitude.</p> <p>On some crossings (10% probability), errors are introduced into the position longitude before encoding. These errors are not self-correcting and can only be removed by a power reset of the transponder. The problem, once triggered can last days, since many transponders are not routinely powered down.</p>	<p>Yes.</p> <p>Will present as a few wild/large positional jumps. Nearly all reports are tagged as low quality (NUC=0) and are discarded, however, some occasional non zero reports get through.</p> <p>Problem is very “obvious”. Could result in incorrect longitudinal position of Flight Data Record track. Can trigger RAM alerts.</p>	<p>Rockwell Collins has successfully introduced a Service Bulletin that solves the problem in Boeing aircraft.</p> <p>The problem is known to exist on Airbus aircraft. Rockwell has advised that a solution is available in their DO260B upgrade.</p> <p>Rockwell Collins may not have a fix for some time. Workaround solutions are being examined by Airbus, Operators and Airservices Australia.</p> <p>The only workaround identified at this time is to power down the transponders before flight to states using ADS-B – after crossing longitude 180. It can be noted that in Airbus aircraft it is not possible to safely power down the transponder in flight.</p> <p>Airbus have prepared a procedure to support power down before flight. Airservices Australia have negotiated with 2 airlines to enact this procedure prior to flights to</p>

Ref.	Problem	Cause	Safety Implications to ATC (Yes / No)	Recommendations
				<p>Australia.</p> <p>An additional partial workaround is : to ensure that procedures exist for ATC to ask the pilot to changeover transponders if the problem is observed. Since there is a 10% chance of the problem occurring on each crossing of ± 180 degrees longitude, the chance that both transponders being affected is 1%.</p> <p>There is no complete workaround available for flights that operate across 180 degrees longitude directly to destination without replacing the transponder. Airbus advised that a new TPR901 transponder compliant with DO260B is available from December 2015. This new transponder does not have such problem.</p>
2.	<p>Rockwell Collins TDR94 Old version.</p> <p>The pattern of erroneous positional data is very distinctive of the problem. (See Figure 2)</p>	<p>Old software typically before version -108. The design was completed before the ADS-B standards were established and the message definitions are different to the current DO260.</p> <p>Rockwell has recommended</p>	<p>Yes.</p> <p>Will present as a few wild positional jumps. Nearly all reports are tagged as low quality (NUC=0) and are discarded, however, some occasional non zero reports get through. Also causes incorrect altitude reports.</p>	<p>Problem well known. Particularly affects Gulfstream aircraft which unfortunately leave the factory with ADS-B enabled from this transponder model.</p> <p>Rockwell has issued a service bulletin recommending that ADS-B be disabled for aircraft with this</p>

Ref.	Problem	Cause	Safety Implications to ATC (Yes / No)	Recommendations
		that ADS-B be disabled on these models.	Problem is very “obvious”.	transponder software. See Service Information Letter 1-05 July 19, 2005. It is easy to disable the transmission. If a new case is discovered, an entry needs to be made to the black list until rectification has been effected.
3.	Litton GPS with proper RAIM processing	Litton GNSSU (GPS) Mark 1 design problem. (Does not apply to Litton Mark II). GPS does not output correct messages to transponder.	No. Perceived GPS integrity changes seemingly randomly. With the GPS satellite constellation working properly, the position data is good. However the reported integrity is inconsistent and hence the data is sometimes/often discarded by the ATC system. The effected is perceived extremely poor “coverage”. The data is not properly “protected” against erroneous satellite ranging signals – although this cannot be “seen” by ATC unless there is a rare satellite problem.	This GPS is installed in some older, typically Airbus, fleets. Data appears “Correct” but integrity value can vary. Performance under “bad” satellite conditions is a problem. Correction involves replacing the GNSSU (GPS) which is expensive. If a new case is discovered, an entry needs to be made to the black list until rectification has been effected.
4.	SIL programming error for DO260A avionics	Installers of ADS-B avionics using the newer DO260A standard mis program “SIL”. a) This problem appears for	No. First report of detection appears good (and is good), all subsequent reports not displayed because the	Would NOT be included in a “black list”. Aircraft with “Dynom avionics” exhibit this behavior. They do not

Ref.	Problem	Cause	Safety Implications to ATC (Yes / No)	Recommendations
		<p>DO260A transponders, with SIL incorrectly set to 0 or 1 (instead of 2 or 3)</p> <p>b) As the aircraft enters coverage, the ADS-B ground station correctly assumes DO260 until it receives the version number.</p> <p>c) The transmitted NIC (DO260A) is interpreted as a good NUC (DO260) value, because no SIL message has yet been received. The data is presented to ATC.</p>	<p>data quality is perceived as “bad” by the ATC system. Operational effect is effectively no ADS-B data. Hence no risk.</p>	<p>have a certified GPS and hence always set SIL = 0. This is actually correct but hence they do not get treated as ADS-B equipped.</p>
5.	Garmin “N” Flight ID problem (See Figure 3)	Installers of Garmin transponder incorrectly set “Callsign”/Flight ID. This is caused by poor human factors and design that assumes that GA aircraft are US registered.	Yes. Flight ID appears as “N”. Inhibits proper coupling.	Can be corrected by installer manipulation of front panel. Does not warrant “black list” activity.
6.	Flight ID corruption issue 1 – trailing “U” Flight ID’s received : GT615, T615U ,NEB033, NEB033U, QF7550, QF7550U, QF7583, QF7583U, QF7585,	TPR901 software problem interfacing with Flight ID source. Results in constantly changing Flight ID with some reports having an extra “U” character.	Yes. Flight ID changes during flight inhibits proper coupling or causes decoupling.	Affects mainly B747 aircraft. Boeing SB is available for Rockwell transponders and B744 aircraft. Rockwell Collins have SB 503 which upgrades faulty -003 transponder to -005 standard.

Ref.	Problem	Cause	Safety Implications to ATC (Yes / No)	Recommendations
	QF7585, QF7585U, QF7594, QFA7521, QFA7531, QFA7531, QFA7531U, QFA7532, QFA7532U, QFA7532W, QFA7550, QFA7552, QFA7581			If a new case is discovered, an entry needs to be made to the black list until rectification has been effected.
7.	Flight ID corruption issue 2	ACSS software problem results in constantly changing Flight ID. Applies to ACSS XS950 transponder Pn 7517800-110006 and Honeywell FMC (pn 4052508 952). ACSS fix was available in Sept 2007.	Yes. Flight ID changes during flight inhibits proper coupling or causes decoupling.	Software upgrade available. If a new case is discovered, an entry needs to be made to the black list until rectification has been effected.
8.	No Flight ID transmitted	Various causes	No. Flight ID not available. Inhibits proper coupling.	Aircraft could “fail to couple with Flight Data Record”. Not strictly misleading – but could cause controller distraction.
9.	ACSS Transponder 10005/6 without Mod A reports NUC based on HFOM.		Yes. Appears good in all respects until there is a satellite constellation problem (not normally detectable by ground systems).	Not approved and hence not compliant with CASA regulations. If known could be added to black list. Configuration is not permitted by regulation.
10.	Occasional small position jump backwards (See Figure 4)	For some older Airbus aircraft, an occasional report may exhibit a small “jump	No. Not detectable in ATC due to	ATC ground system processing can eliminate these.

Ref.	Problem	Cause	Safety Implications to ATC (Yes / No)	Recommendations
		back” of less than 0.1 nm Root cause not known	extrapolation, use of latest data and screen ranges used.	
11.	Older ACSS transponders report integrity too conservatively	Design error reports integrity one value worse than reality	No. In poor GPS geometry cases the ATC system could discard the data when the data is in fact useable. Will be perceived as loss of ADS-B data.	Can be treated in the same manner as a loss of transponder capability.
12.	Intermittent wiring GPS transponder	ADS-B transmissions switch intermittently between INS position and GPS position.	Yes. Normally the integrity data goes to zero when INS is broadcast, but sometimes during transition between INS and GPS, an INS position or two can be broadcast with “good” NUC value. Disturbing small positional jump.	If a new case is discovered, an entry needs to be made to the black list until rectification has been effected.
13.	Wrong ICAO Aircraft Address	Installation error	No. No direct ATC impact unless a rare duplicate is detected.	This is not a direct ADS-B problem, but relates to a Mode S transponder issue that can put TCAS at risk. Cannot be fixed by black list entry. Needs to be passed to regulator for resolution.

Ref.	Problem	Cause	Safety Implications to ATC (Yes / No)	Recommendations
14.	Toggling between high and low NUC (See Figure 5)	Faulty GPS receiver/ADS-B transponder	No. ATC will see tracks appear and disappear discretely. No safety implications to ATC.	While it is normal for NUC value to switch between a high and low figure based on the geometry of GPS satellites available, it is of the view that more should be done to examine this phenomenon. It is observed that such switching between high and low NUC occurs on certain airframe and not on others. The issue was raised to the airlines so as to get a better understanding. On one occasion, the airline replied that a module on their GPS receiver was faulty. On another occasion, the airline replied that one of the ADS-B transponder was faulty. Good NUC was transmitted when the working transponder was in use and poor NUC was transmitted when the faulty ADS-B transponder was in use.
15.	Consistent Low NUC (See Figure 6)	GNSS receivers are not connected to the ADS-B transponders.	No. Data shall be filtered out by the system and not detectable in ATC	Not considered a safety problem but a common phenomenon in the Region – the concerned aircraft will be treated equivalent to “aircraft not equipped with ADS-B”. While it is normal for aircraft to transmit low NUC, it is of the view that “consistent low NUC” could be due to the avionics problem (e.g. GNSS receiver is not connected to

Ref.	Problem	Cause	Safety Implications to ATC (Yes / No)	Recommendations
				<p>the ADS-B transponder).</p> <p>It is recognised that operators may not be aware that their aircraft are transmitting unexpected low NUC / NIC values, due to equipment malfunction. Hence, it is desirable for States to inform the operators when unexpected low NUC values are transmitted, where practicable.</p> <p>Concerned airline operators are required to take early remedial actions. Otherwise, their aircraft will be treated as if non-ADS-B equipped which will be requested to fly outside the ADS-B airspace after the ADS-B mandate becomes effective.</p>
16.	ADS-B position report with good integrity (i.e. NUC >= "4") but ADS-B position data are actually bad as compared with radar (met criteria 5.2(a))	Faulty ADS-B avionics	<p>Yes.</p> <p>As the ground system could not "automatically" discard ADS-B data with good integrity (i.e. NUC value >=4), there could be safety implications to ATC.</p>	<p>The problem should be immediately reported to the concerned CAA/operators for problem diagnosis including digging out the root causes, avionics/GPS types etc., and ensure problem rectification before the ADS-B data could be used by ATC.</p> <p>Consider to "blacklist" the aircraft before the problem is rectified.</p>

Ref.	Problem	Cause	Safety Implications to ATC (Yes / No)	Recommendations
17.	FLTID transmitted by ADS-B aircraft does not match with callsign in flight plan (see Figures 7a – 7d)	Human errors	Yes. Could lead to screen clutter - two target labels with different IDs (one for radar and another for ADS-B) being displayed, causing potential confusion and safety implications to ATC.	Issue regulations/letters to concerned operators urging them to set FLTID exactly match with callsign in flight plan.
18	B787 position error with good NIC	<p><u>Issue 1:</u> Software issue - surveillance system inappropriately “coasts” the position when data received by the transponder is split across multiple messages.</p> <p>System seems to self correct after some time. Can be corrected by surveillance system power off.</p> <p><u>Issue 2:</u> Data packets were not being distributed to the transponder when the internal timing between different elements of the Integrated Surveillance System became synchronized.</p>	Yes. Misleading position presentation which is typically detected by ATC observing aircraft “off track” when in fact it is “on-track”.	<p>Boeing performed a change to the B787 Type Certificate for incorporation of the upgraded ISS software in March of 2017. All B787 aircraft delivered after Line number 541 have the upgraded ISS software which corrects this issue.</p> <p>Boeing released Service Bulletin B787-81205-SB340036-00 on 30 June 2017. Note that this Service Bulletin is available at no cost to the operator, and includes the concurrent requirement to implement Boeing Service Bulletin B787-81205-SB340005-00.</p> <p>On 9 February 2018, FAA released a proposed Airworthiness Directive (AD) for the B787, which will require the application of Boeing</p>

Ref.	Problem	Cause	Safety Implications to ATC (Yes / No)	Recommendations
				Service Bulletin B787-81205-SB340036-00. Comments on this proposed AD were due on 26 March 2018, and a Final AD is expected to be issued by May 2018, requiring compliance within one year of issuance. Operators are encouraged to implement the service bulletin as early as possible.
19	A number of airlines have reported or experienced ADS-B outages for complete flight sectors in A330 aircraft. Appears as low reliability ADS-B and has afflicted both A & B side at same time.	Being actively investigated. One airline has implemented on-board recording which confirms that the MMRs are not providing HIL/HPL to the transponder whilst continuing to provide HFOM, GPS alt etc	No. Equivalent to a failed transponder.	Aircraft must be managed procedurally if outside radar coverage.
20	A380 flight ID lost after landing	For the A380 fleet, it has been confirmed that for some seconds after landing, the flight ID is set as invalid by FMS to AESS. Consequently, the current AESS design uses, as per design, the Aircraft Registration Number as a back-up source for A/C flight identification field in ADS-B broadcast messages.	No.	The correction to this logic is planned for next AESS standard release; planned for 2017.” Only a problem for arriving aircraft on surface surveillance systems.
21	A350 ADS-B On-ground	On departure, A350 aircraft	Yes. where ADS-B is used for	Airbus is in discussion with FAA

Ref.	Problem	Cause	Safety Implications to ATC (Yes / No)	Recommendations
	Performance	will initially use INS derived position for ADS-B reports when taxiing and only use GNSS when entering the runway. INS positions can drift leading to inaccurate position reports.	surface movement display	and EUROCONTROL about this issue.
22	Incorrect Ground Bit Setting (GBS) in both Mode S Interrogation Reply and ADS-B Downlink	Occasionally, some airborne aircraft will incorrectly set ground bit as “1” meaning they are on ground, while some landed aircraft incorrectly set ground bit as “0” meaning they are airborne. This could confuse the ATC system, by not showing the airborne targets as the system thought they are on ground, or forming tracks for landed targets triggering alarms against other taking-off aircraft.	Yes. Misleading information shown on ATC system. Aircraft not visible to TCAS and will not reply to all-call interrogations.	States/Administrations contact the concerned airline operators for remedial actions.
23	Rockwell TSS-4100 track extrapolation issue.	The TSS-4100 shares software with the Rockwell Collins ISS transponder in the B787, and the software defect in the B787 ISS reported at SURICG/2 also exists in the TSS-4100.	Yes. Misleading position presentation which is typically shown on ATC system.	FAA Airworthiness Directive (AD) 2017-22-14 was issued on 20 Dec 2017. The compliance date for this AD is 20 Dec 2018 (or 750 hours in service, whichever occurs first). The aircraft’s avionics were subject to the

Ref.	Problem	Cause	Safety Implications to ATC (Yes / No)	Recommendations
				AD and FAA determined that the actions required by the AD had not yet been performed. After communicating with the operator, the FAA placed this aircraft on the No Services Aircraft List (NSAL) until the actions required under the AD were completed. Once these actions were completed, then this aircraft was removed from the NSAL
24	Embraer 170 track jumping issue	Unknown as being a random, occasional issue with no clear fault diagnosis available from Honeywell. FAA has decided that when the next E170 aircraft is detected with this issue, it will be immediately placed on the FAA's No Services Aircraft List (NSAL). Simultaneously, FAA will notify Embraer and Honeywell of the affected aircraft and request that appropriate engineering personnel be sent to inspect and test the affected aircraft.	Yes. Misleading position presentation which is typically shown on ATC system.	In all of the cases of this issue to date, removing and replacing the transponders cleared whatever the issue was. This issue has never recurred on the same aircraft. Bench testing by Honeywell avionics engineering of the removed transponders has revealed no faults or anomalies. As such, States/Administrations to consider removing and replacing the transponders concerned if issue observed.
25	Airbus Single Aisle production wiring issue	FAA has observed 17 Airbus Single Aisle aircraft from two airlines with missing Length-Width Codes (LWC	No.	Airbus plans to release a Service Bulletin to correct this issue. FAA is unaware if other Airbus Single Aisle production aircraft were

Ref.	Problem	Cause	Safety Implications to ATC (Yes / No)	Recommendations
		is a message element in DO-260B/ED-102A that is required by both the US and European mandates). FAA believes that this was a production line wiring issue.		affected by this issue
26	Boeing 777-300ER production wiring issue	FAA has observed at least 10 Boeing B777-300ER aircraft with missing or improper NACv/SDA/eCat/LWC message elements (these are message elements in DO-260B/ED-102A that are required by both the US and European mandates (eCat is FAA shorthand for Emitter Category). After notification, Boeing reported to FAA that this was a production line parity pin wiring issue.	No.	On 7 July 2017, Boeing released Service Bulletin SB 777-34-0281 to correct this issue. Boeing has informed FAA that all affected B777 operators have been notified.



Figure 1 - Track Jumping problem with TPR901



Figure 3 - Garmin “N” Flight ID problem

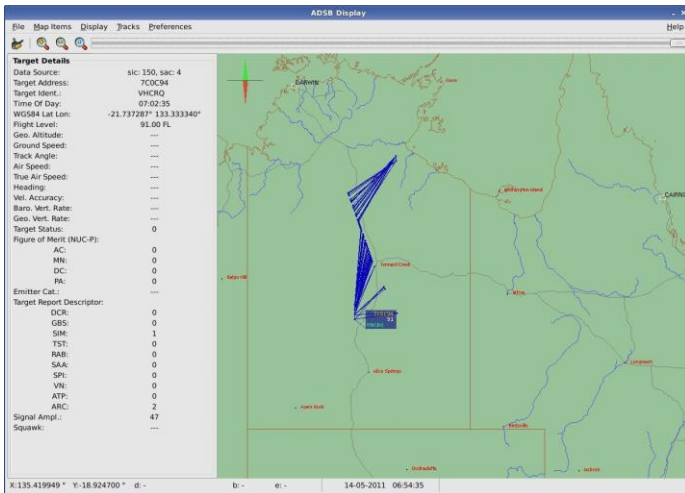

Figure 2 - Rockwell Collins TDR94 Old version. The pattern of

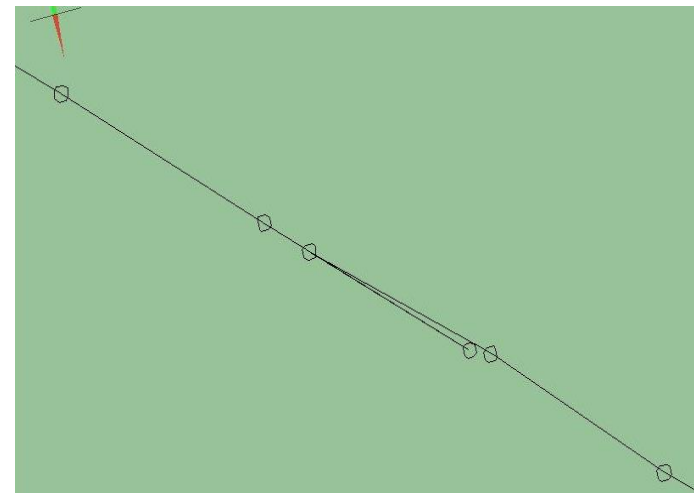

Figure 4 - Occasional small position jump backwards

erroneous positional data is very distinctive of the problem

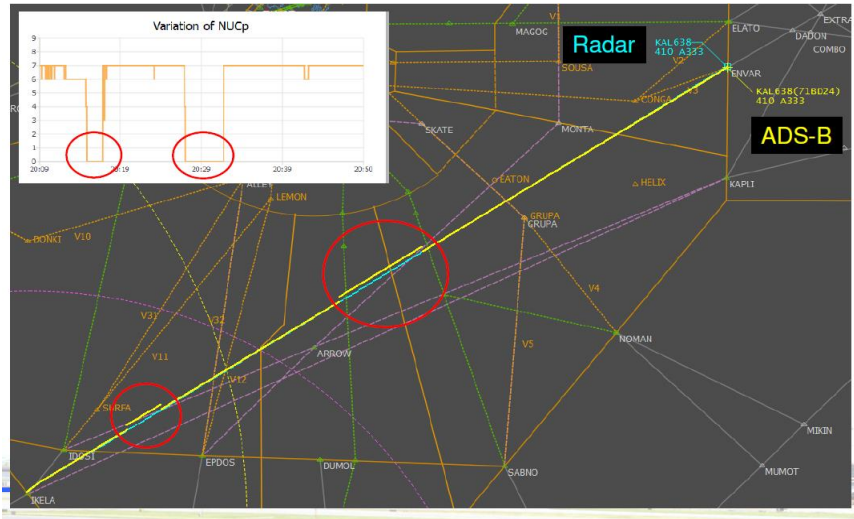

Figure 5 - NUC value toggling

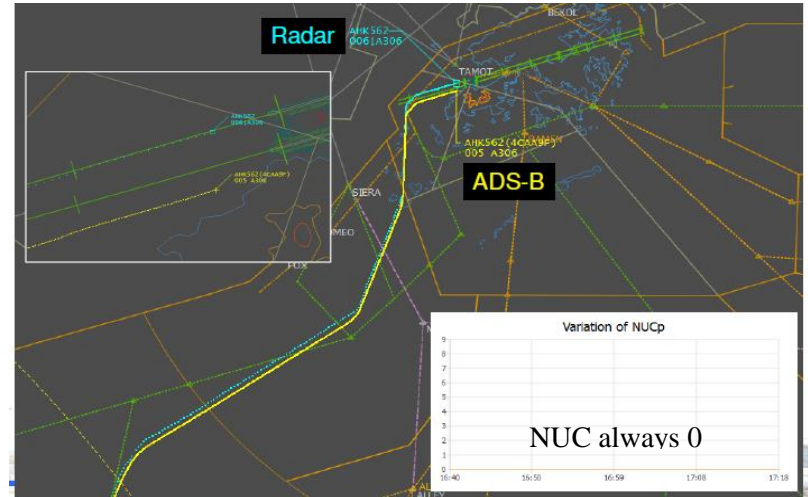

Figure 6 – Consistent low NUC

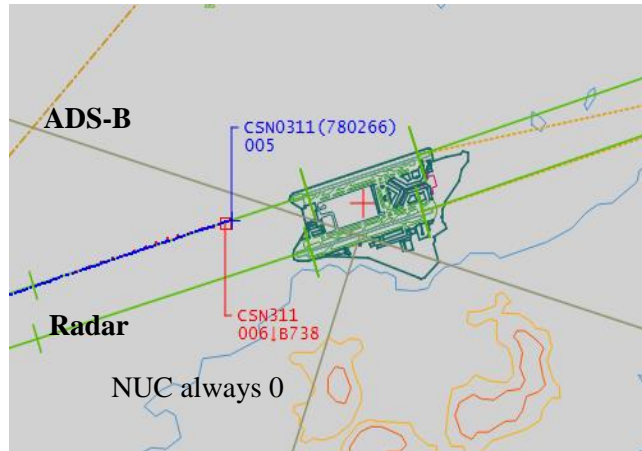

Figure 7a - Additional zero inserted

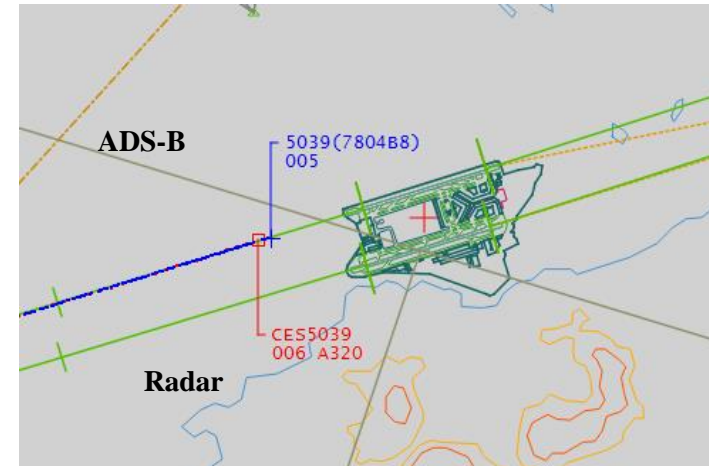

Figure 7b - ICAO Airline Designator Code dropped

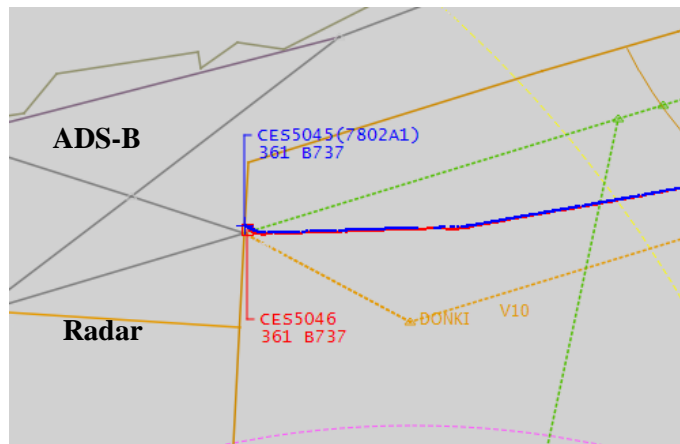

Figure 7c - Wrong numerical codes entered

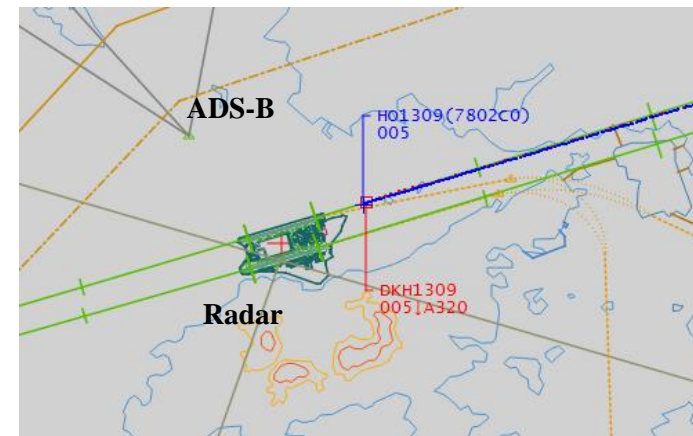
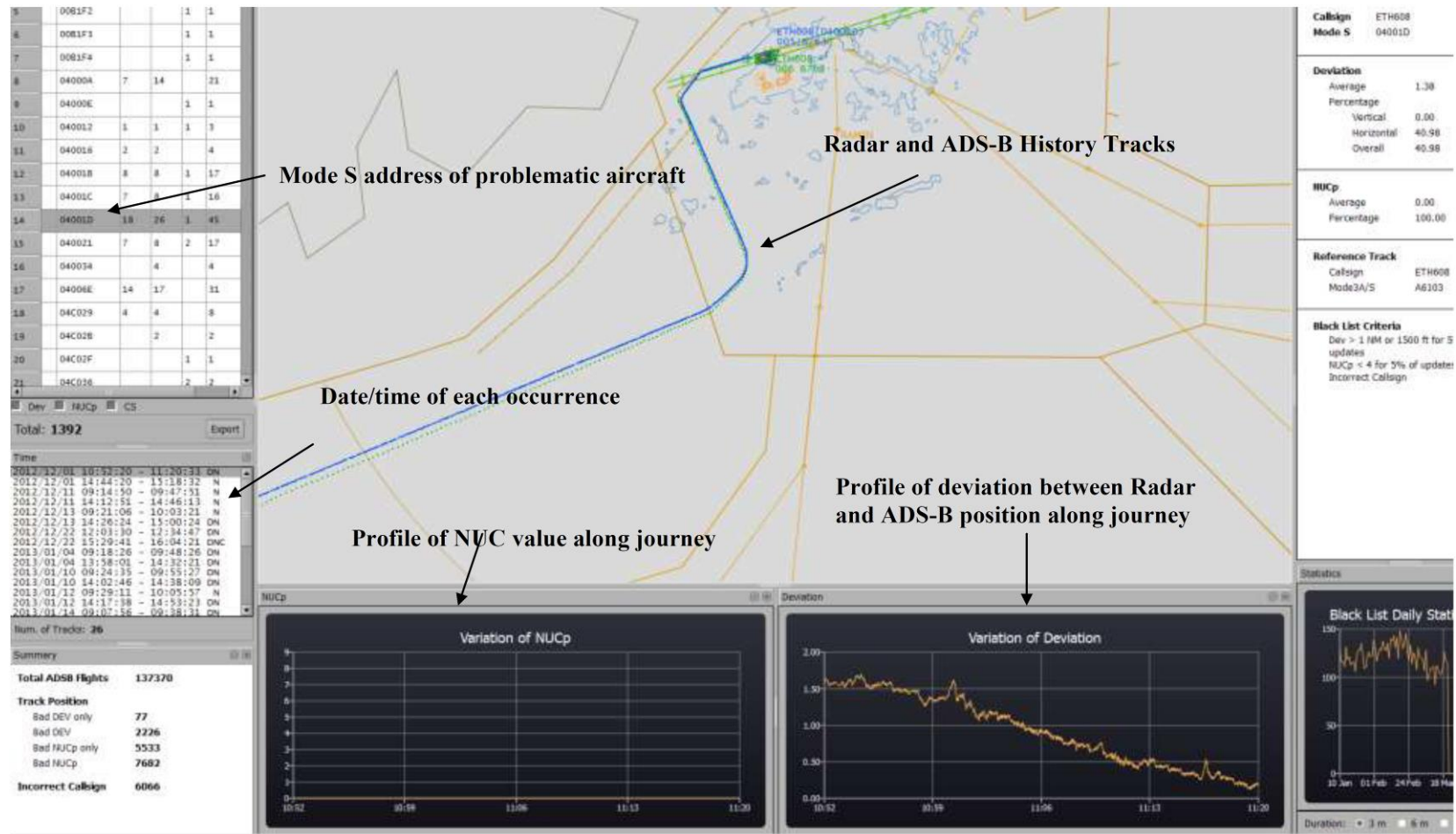

Figure 7d - IATA Airline Designator Code used

Attachment B - Sample screen shot of a system to monitor and analyse performance of ADS-B avionics



A Template for ADS-B Mandate/Regulations for Aircraft Avionics

- (1) On and after dd/mm/yyyy, if an aircraft carries 1090MHz extended squitter (1090ES) ADS-B transmitting equipment for operational use in xxxxxxxx territory, the equipment must have been certificated as meeting :¹
 - (a) European Aviation Safety Agency - Certification Considerations for the Enhanced ATS in Non-Radar Areas using ADS-B Surveillance (ADS-B-NRA) Application via 1090 MHz Extended Squitter (AMC 20-24), or
 - (b) European Aviation Safety Agency - Certification Specifications and Acceptable Means of Compliance for Airborne Communications, Navigation and Surveillance Subpart D — Surveillance (SUR) (CS-ACNS.D.ADS-B), or
 - (c) Federal Aviation Administration – Advisory Circular No: 20-165A (or later versions) Airworthiness Approval of Automatic Dependent Surveillance – Broadcast (ADS-B) Out Systems, or
 - (d) the equipment configuration standards in Appendix XI of Civil Aviation Order 20.18 of the Civil Aviation Safety Authority of Australia.

- (2) On and after dd/mm/yyyy, if an aircraft operates on airways (insert routes).....at or above FLXXX.....(or in defined airspace boundaries at or above FLXXX):²

The aircraft must carry serviceable 1090MHz extended squitter (1090ES) ADS-B transmitting equipment that has been certificated as meeting :-

- (a) European Aviation Safety Agency - Certification Considerations for the Enhanced ATS in Non-Radar Areas using ADS-B Surveillance (ADS-B-NRA) Application via 1090 MHz Extended Squitter (AMC 20-24), or
 - (b) European Aviation Safety Agency - Certification Specifications and Acceptable Means of Compliance for Airborne Communications, Navigation and Surveillance Subpart D — Surveillance (SUR) (CS-ACNS.D.ADS-B), or
 - (c) Federal Aviation Administration – Advisory Circular No: 20-165A (or later versions) Airworthiness Approval of Automatic Dependent Surveillance – Broadcast (ADS-B) Out Systems, or
 - (d) the equipment configuration standards in Appendix XI of Civil Aviation Order 20.18 of the Civil Aviation Safety Authority of Australia.
-
- (3) An aircraft carrying 1 090 MHz extended squitter (1090ES) ADS-B equipment shall disable ADS-B transmission unless:
 - (a) the aircraft emits position information of an accuracy and integrity consistent with the transmitted value of the position quality indicator; or
 - (b) the aircraft always transmits a value of 0 (zero) for one or more of the position quality indicators (NUCp, NIC, NACp or SIL); or
 - (c) the operator has received an exemption granted by the appropriate ATS authority.

Note: States are urged to include at least the standards stated in the template. States may include other standards allowed by the State’s regulations.

¹ This paragraph ensures all aircraft operating in the airspace, if equipped with ADS-B, are compliant to standards.

² This paragraph provides mandate requirements within certain parts of the airspace

An Example of Advice to Operators Concerning Inconsistency Between ADS-B Flight Planning and Surveillance Capability

1 Background

Newer technologies for aircraft surveillance are now available – such as Mode S and ADS-B – which in many aircraft are installed as replacements for older Mode A/C transponders.

Air Traffic Control makes use of these new capabilities, and uses the Flight Plan information as a decision support tool – to allow the Air Traffic Controller to predict the surveillance capability of a particular aircraft before it enters radar or ADS-B coverage.

Requirements for ADS-B and Mode S (**insert local reference document if applicable**) may mean that if flight planning does not accurately reflect the aircraft capability, services may be withheld (for example if ADS-B is mandatory, but not indicated on the flight plan – **this section to be modified for local requirements**).

2 Flight Planning Requirements for Transponder and ADS-B

The flight planning requirements for aircraft are described in (**local document reference or ICAO DOC 4444 Appendix 2**) and repeated below.

Surveillance Equipment

N if no surveillance equipment for the route to be flown is carried, or the equipment is unserviceable

OR

INSERT one or more of the following descriptors, to a maximum of 20 characters, to describe the serviceable surveillance equipment and/or capabilities on board:

SSR Modes A and C

A Transponder — Mode A (4 digits — 4 096 codes)

C Transponder — Mode A (4 digits — 4 096 codes) and Mode C

SSR Mode S

E Transponder — Mode S, including aircraft identification, pressure-altitude and extended squitter (ADS-B) capability

H Transponder — Mode S, including aircraft identification, pressure-altitude and enhanced surveillance capability

I Transponder — Mode S, including aircraft identification, but no pressure-altitude capability

L Transponder — Mode S, including aircraft identification, pressure-altitude, extended squitter (ADS-B) and enhanced surveillance capability

P Transponder — Mode S, including pressure-altitude, but no aircraft identification capability

S Transponder — Mode S, including both pressure altitude and aircraft identification capability

X Transponder — Mode S with neither aircraft identification nor pressure-altitude capability

Note : Enhanced surveillance capability is the ability of the aircraft to down-link aircraft derived data via a Mode S transponder.

ADS-B

B1 ADS-B with dedicated 1 090 MHz ADS-B “out” capability¹

B2 ADS-B with dedicated 1 090 MHz ADS-B “out” and “in” capability¹

U1 ADS-B “out” capability using UAT

U2 ADS-B “out” and “in” capability using UAT

V1 ADS-B “out” capability using VDL Mode 4

V2 ADS-B “out” and “in” capability using VDL Mode 4

3 Additional information

The capability of your aircraft transponder, and ADS-B capability, will typically be available in the transponder manual, or in the aircraft flight manual for the aircraft. For General Aviation aircraft, the most common configurations for filing in the flight plan item10b will be (listed in order of capability).

EB1 – An ADS-B equipped aircraft would typically file this to indicate the Mode S transponder capability with ADS-B out.

S – The majority of Mode S transponders (without ADS-B) will support pressure altitude information and Flight ID transmission.

C – For aircraft with an older Mode A/C transponder – most of which provide pressure altitude capability.

Less common configurations in General Aviation will include:

H, LB1 or LB2 – Enhanced surveillance capability is more usually associated with higher end aircraft. ADS-B IN (B2) is relatively rare at this time, but may be available for some aircraft.

I, P or X – Most Mode S transponders will support Flight ID and pressure altitude, so these configurations are not common.

A – some low end GA aircraft may not provide pressure altitude information.

U1 or U2 – these ADS-B technologies are only authorized in a limited number of countries in the Asia Pacific Region.

Planning designations not to be used in Asia Pacific:

V1 or V2 – these ADS-B technologies are not authorised for use in Asia Pacific Region.

Remember:

Always flight plan the correct surveillance capability for your aircraft. If in doubt, consult the transponder manual, aircraft flight manual, or your Licenced Aircraft Maintenance Engineer.

¹ Based on current version of ICAO Doc 4444

Checklist of Common Items or Parameters for the Monitoring of ADS-B System

1 ADS-B Ground Station

Site Monitoring

- Receiver Sensitivity
- Antenna Cable
- GPS Health
- Coverage Check
- Probability of Detection
- Station Service Availability
- Receiver Status

Remote Control & Monitoring (RCMS)

- CPU Process Operation
- Temperature
- ASTERIX Output Load and Link Status
- Time Synchronization
- GPS Status
- Power Status
- Site Monitor Status
- Memory Usage
- Software Version (Operating System and RCMS Application)

Logistic Support Monitoring

- Record all failures, service outage and repair/return to service times

2 ADS-B Equipage Monitoring

- Update and maintain list of ADS-B equipped airframe details database
- Identify aircraft non-compliant to regional mandate

3 ADS-B Avionics Monitoring

- Track Consistency
- Valid Flight ID
- Presence of NACp/NIC/NUC Values
- Presence of Geometric Altitude
- Correctness of ICAO Aircraft Address
- Avionics Configuration and Connections
- Update and maintain list of aircraft with faulty avionics

4 ADS-B Performance Monitoring

- Percentage of aircraft with good integrity reports
- Accuracy of ADS-B Horizontal Position (Based on a reference sensor)
- Deviation between Geometric and Barometric Height
- Monitor the number of position jumps
- Message interval rate

5 ADS-B Display on ATC Display

- Split Track – ADS-B reported position might be off
- Coupling Failure – Wrong aircraft ID
- Duplicated ICAO Aircraft Address
- Display of data block

BASELINE ADS-B SERVICE PERFORMANCE PARAMETERS

The following table provides guidelines for various performance requirements of ADS-B Category (Tier) 1, 2 or 3 services that States may consider when acquisition of an ADS-B managed service agreement with a service provider:

Service Parameter	Guidance	Category 1 (Tier 1) 5Nm separation capable commensurate with Radars (separation/vectoring/high performance with reliability, integrity & latency)	Category 2 (Tier 2) Situational awareness similar to ADS-C (safety-net alerts, SAR, supports procedural separation without voice, not 5nm separation)	Category 3 (Tier 3) Position Reporting with Enhanced Flight Operation
Aircraft Updates	Recommended	0.5 second < Interval < 5 seconds as Operationally required	0.5 second < Interval < 20 seconds as Operationally required	0.5 second < Interval < 60 seconds as Operationally required
	Maximum	0.5 second < Interval < 10 seconds as Operationally required		
Network Latency	Recommended	95%: < 2 seconds of receiver-station output	95%: < 15 seconds of receiver-station output	95%: < 60 seconds of receiver-station output
Reliability 1	Recommended	2 autonomous receiver-stations including antenna, each providing data, no common point of failure	1 unduplicated receiver-station including antenna	1 unduplicated receiver-station including antenna
Reliability 2 - MTBF	Recommended	Each receiver-station including antenna to have MTBF >10,000 hrs	Each receiver-station including antenna to have MTBF >10,000 hrs	Each receiver-station including antenna to have MTBF >10,000 hrs
Reliability – Communications Infrastructure	Recommended	Completely duplicated, no common point of failure	Unduplicated, MTBF > 400 hrs	Unduplicated, MTBF> 200 hrs
Reliability – Total ADS-B Service	Recommended	Total Service MTBF >50,000 hrs	Total Service MTBF > 400hrs	Total Service MTBF> 200 hrs

Service Parameter	Guidance	Category 1 (Tier 1) 5Nm separation capable commensurate with Radars (separation/vectoring/high performance with reliability, integrity & latency)	Category 2 (Tier 2) Situational awareness similar to ADS-C (safety-net alerts, SAR, supports procedural separation without voice, not 5nm separation)	Category 3 (Tier 3) Position Reporting with Enhanced Flight Operation
Availability – Total ADS-B Service	Recommended	Total Service Availability > .999	Total Service Availability >.95	Total Service Availability >.90
Integrity – Ground Station	Recommended	Site monitor System Monitoring	Site monitor System Monitoring	System Monitoring
	Minimum	System Monitoring	Not required	Not required
Integrity – Data Communications & Processing	Recommended	All systems up to ATM system, errors < 1 x 10E-6	All systems up to ATM system, errors < 1 x 10E-6	All systems up to ATM system, errors < 1 x 10E-6

The choice of category (tier) could be based upon a number of factors including the following,

- a) The desired service
- b) The available budget
- c) The available ATC automation system & its capabilities and/or interim display systems
- d) ATC training and ratings
- e) Availability of appropriately tailored ATC procedures

States could initially choose one level and transition to another at a later time. For example, Category (Tier) 2 could be used to add additional safety nets/situational awareness and gain operational experience during the initial stage, moving later to a full separation service using Category (Tier) 1.

Note: The Performance Based Surveillance Sub Group of the ICAO Surveillance Panel is reviewing performance standards for surveillance systems generally. A future update to the requirements in the above table may be based on the outcomes of that panel.

**GUIDANCE MATERIAL ON
GENERATION, PROCESSING & SHARING of ASTERIX
CATEGORY 21 ADS-B MESSAGES
(Including Attachments A, B, C & D)**

1. INTRODUCTION

1.1 The “All Purpose Structured Eurocontrol Surveillance Information Exchange” (ASTERIX) Category 21 is a data format standard globally accepted by the Air Traffic Management (ATM) system manufacturing industry for sharing of ADS-B data with ATM automation system.⁸ Asterix Category 21 data is used to convey ADS-B data from ADS-B receiver stations to ATC processing and display system. This guidance material discusses various aspects of this process. Since the ASTERIX Category 21 edition 0.23 was issued in November 2003, it has undergone continuous revisions with some 19 subsequent editions. The focus of this guidance material is to concentrate on 1090ES ADS-B data using:

- a) RTCA DO-260 (Version 0);
- b) RTCA DO-260A (Version 1); and
- c) RTCA DO-260B (Version 2)

1.2 The ASTERIX Category 21 edition 1.0 issued in August 2008 fully incorporated the DO260A standard while edition 2.1 issued in May 2011 fully incorporated the latest DO260B standard. The latest edition (as at April 2018) is edition 2.4.

2. ASTERIX CAT 21 IN ASIA AND PACIFIC REGIONS

2.1 To ensure interoperability of ADS-B receiver stations in the Asia Pacific (ASIA/PAC) Regions, during the 16th APANPIRG Meeting held in August 2005, the ASTERIX Category 21 edition 0.23 which had incorporated DO260 standard was adopted as the baselined ADS-B data format for deployment of ADS-B receiver stations and sharing of ADS-B data in the ASIA/PAC Regions. At that time DO260A and DO260B standards were not defined.

3. CHOICE OF ASTERIX VERSION NUMBER

3.1 The Asterix standard has been developed over many years. Stability in the standard is desirable so that ADS-B receiver station designers and ATM automation designers and manufacturers can build interoperable systems with confidence. Because ADS-B technology has been evolving over the years, and will continue to do so, it is not surprising that the Asterix standard has also developed along with the ADS-B link technology standards to grasp the best benefits of its intended design.

⁸ FAA utilise Asterix Cat 33 for ADS-B message distribution.

3.2 During 2005, Asia Pacific decided to use Ed0.23 as the edition for sharing ADS-B data between states. This version provides adequate information so that useful ATC operational services can be provided including ATC 3 nautical mile and 5 nautical mile separation services. Ed0.23 can be used with DO260, DO260A and DO260B ADS-B avionics/receiver stations to provide basic ATC operational services. However, Ed0.23 cannot fully support all the capabilities offered by DO260A and DO260B.

3.3 Nearly all Ed0.23 data items can be “re-constructed” from a received Ed2.1 data stream. However, most of the special DO260A/B data items cannot be “re-constructed” from an Ed0.23 data stream. In terms of domestic use and data sharing with other ANSPs concerning ADS-B data, several options exist for ANSPs as follows:

Option	Domestic use	Data sharing
1	Ed0.23	Ed0.23. This is the default and basic standard.
2	Ed2.1	Ed0.23. This will require some conversions to occur, probably through an ADS-B format conversion and filter system (see Paragraph 11), between a domestic system and a foreign system. Difficulties may exist if the domestic ATM system requires special DO260A/B data items, since they cannot all be re-constructed from the external foreign Ed0.23 data stream.
3	Ed2.1	Ed2.1. Must negotiate bilaterally with data sharing partner regarding exact version to be used to achieve the intended functions.

Note: In this table, Ed2.1, a later DO260B compliant Asterix Cat 21 edition, is chosen as a representation of an Asterix Cat 21 edition after Ed0.23. There exists other Asterix CAT 21 editions (e.g. 0.26, 1.3, 2.4 etc.) after Ed0.23 that could be used by ANSPs for domestic and data sharing use.

4. SPECIFICATION OF ASTERIX MESSAGE PROCESSING

4.1 Care is needed to understand the difference in specifications :

4.2 **Asterix Cat 21:** Defines the characteristics of the data ON the interface including fields that are mandatory on the interface.

4.3 **ADS-B receiver station specifications:** To define the Asterix standard, the ANSP must also define which optional Asterix data items are required to be delivered on the Asterix interface, when the appropriate data is received from the aircraft. It is desirable that suppliers be required to:

a) indicate how the receiver station processes and outputs every received DO260, DO260A and DO260B data element into an Asterix data element/field; and

b) indicate which and how each Asterix data element and field presented at the output are populated.

4.4 **ATM automation system specifications:** Defines which received Asterix data element and fields are processed and how they are processed. Also defines which Asterix optional data fields are required by the ATM automation systems (if any). ANSPs that specify ADS-B receiver stations and ATM automation systems need to consider carefully and clearly about what they desire to achieve. Specifications which simply require compliance with a particular Asterix edition will be inadequate in most circumstances. In particular ANSPs, together with their suppliers should :

- a) Specify the Asterix standard edition to be used. This defines the message formats that are placed on the link between ADS-B receiver station and downstream systems like ATM automation, recording & analysis systems, bypass ATC systems and foreign ANSPs. The edition will define which messages elements are mandatory in each message (very few fields) and a large number of optional fields. The optional fields can only be filled if relevant data is received from the aircraft. The optional fields will only be filled if the receiver station specification requires them to be filled.
- b) Specify the ADS-B receiver station behaviour so that when data is received from the aircraft, the receiver station is required to fill appropriate optional Asterix data fields.
- c) Specify the ATM automation system behaviour including appropriate semantic and syntax checks applied to the Asterix data, including any triggers for the system to discard data. The processing applied to each received Asterix data field should be specified. The ATC system should discard any messages with unexpected Asterix categories without discarding messages with known and defined Asterix categories.

5. MANDATORY FIELDS : ASTERIX AND 1090ES ADS-B

5.1 Asterix Cat 21 has been designed to support multiple datalinks. It has been defined to support data fields which are not available in the 1090ES standards. Therefore some data items and fields are not relevant when 1090ES is used.

5.2 The standard itself defines various items as optional or mandatory. This is defining what is ON the interface. It does NOT specify the behaviour of the transmitting receiver station nor the behaviour of the receiving ATM automation system.

5.3 When a single link technology has been chosen it may be sensible to diverge from the formal Ed0.23 standard to reduce the required Asterix datalink bandwidth. E.g.: in an environment with only 1090ES, it is unnecessary to transmit “Link Technology Indicator”. Asterix Cat 21 Ed 2.1 allows this selection.

Data Items	Description	Mandatory (M) or Optional (O) items as per ASTERIX Category 21	
		Version 0.23 Specification	Version 2.1 Specification
I021/010	Data Source Identification	M	M
I021/030	Time of Day	M	N/A
I021/071 or I021/073	Time of Applicability of Position or Time of Message reception for position	N/A	One of these is must be transmitted
I021/040	Target Report Descriptor	M	M
I021/080	Target Address	M	M
I021/210	Link Technology Indicator/MOPS version	M	O

6. GENERATION OF ASTERIX AT AN ADS-B RECEIVER STATION

6.1 The following general principles should be adopted:

6.2 Commensurate with link bandwidth availability, transmit all mandatory Asterix data items and also transmit those Asterix data items that are operationally desirable. That is, when the appropriate aircraft transmission is received by the ADS-B receiver station, the data should be transmitted to the ATC system for operational use or for technical recording and analysis use. If no aircraft transmission data is received to fill an Asterix data item during any update cycle, the data item should not be included in the Asterix data stream to reduce bandwidth requirements.

6.3 **Group 1 (Mandatory Data Items):** An Asterix Cat21 message should not be transmitted unless the mandatory data items defined in Appendix A are all present.

6.4 **Group 2 (Desirable Data Items) :** The data items defined in Appendix B are operationally desirable which should always be transmitted in the Asterix Cat 21 messages whenever the data are received by the 1090ES receiver station from aircraft (if allowed by the relevant Asterix standard chosen).

6.5 **Group 3 (Optional Data Items) :** The data items defined in Appendix C are considered optional and may or may not need to be transmitted depending on availability of such data from aircraft and/or other specific operational needs.

6.6 **Group 4 (Future Data Items):** The following data are defined in the DO260A and DO260B standards but are not yet defined in the Asterix standard. This group is provided for information only. It illustrates the need for system designers to provide for future adaptability when possible and when cost effective to do so. Not only will the Asterix standard continue to evolve, but changes to DO260 can also be anticipated within the decade.

- a) Target heading: Information from DO260A/B Target state and status messages (On condition messages). These could be used for detection of pilot errors in selection of heading/altitude; and
- b) GPS Offset: Could be used to more accurately display aircraft position on an airport surface, or better detect that an aircraft has passed an airport hold point.

6.7 When developing a specification for an ADS-B receiver station, it is considered necessary that the specification requires the transmission of all data items that are operationally desirable (Group 2), when such data are received from the aircraft, in addition to the data items that are mandatory (Group 1) in Asterix messages. Whether Group 3 optional data items will need to be transmitted or not should be configurable on item-by-item basis within the ADS-B receiver station depending on specific operational needs.

7. PROCESSING OF ASTERIX ADS-B DATA AT THE ATC SYSTEM

7.1 An Asterix Cat21 message should not be accepted by the ATC system for processing unless it includes at least all the Group 1 data items.

7.2 The ATC system should process all received Asterix Cat21 message data items that bring operational benefits (i.e. Group 2 data items). An ATM automation specification should require that the system appropriately process those Group 2 data items depending on specific operational need. Whether the ATC system will process Group 3 optional data items will depend on specific operational needs.

8. DATA SHARING OF ASTERIX ADS-B DATA

8.1 In principle, all data receiving from the shared ADS-B receiver station should be delivered to the receiving party as far as practicable without filtering, unless owing to technical reasons such as the need to convert the data from one ASTERIX format to another, or it is requested by the receiving party of the data.

8.2 It is considered necessary that all data items that are mandatory in Asterix messages (i.e. Group 1 data items) and operationally desirable (i.e. Group 2 data items) when such data are received from aircraft, should be included in data sharing. In the event that the data have to be filtered, the list of optional data items (i.e. Group 3 data items) needs to be shared will be subject to mutual agreement between the two data sharing parties concerned.

9. ISSUE RELATED TO DO260A

9.1 Support of DO260A using Asterix Cat 21 Ed0.23

- a) DO260A was developed after Ed0.23 of Asterix was defined. Therefore, Ed0.23 does not directly support DO260A. However, receiver station software can generate

useful Ed0.23 Asterix data from DO260A reports through use of the following techniques;

- b) A useful I021/090 Figure of Merit can be generated from DO260A messages. Some implementations have a table, which defines the FOM/PA to be generated for each combination of SIL, NIC and NAC. The contents of the table can be offline defined to generate the appropriate FOM/PA values. The downstream ATC system can then process DO260A reports as if they were DO260 reports; and
- c) If there is a particular need for the ATC system to have access to the NIC/NAC or SIL or other data item that exist in DO260A (but not in DO260), then users may need to consider a more recent version of Cat 21.

9.2 Support of DO260A using Asterix Cat 21 Ed 1.0 or Ed2.1 (or later versions)

- a) When DO260A is used, then the ANSP could decide to use Asterix Cat 21 Ed1.0 (or later versions) or Ed2.1 (or later versions); and
- b) Readers are invited to carefully examine the DO260A fields (see Appendix D) to determine if the benefits of additional DO260A fields are large enough to warrant adoption of Asterix Cat 21 Ed1.0 (or later versions) or Ed2.1 (or later versions).

10. ISSUE RELATED TO DO260B

10.1 Support of DO260B using Asterix Cat 21 Ed0.23

- a) DO260B was developed some years after DO260A. Therefore, Asterix Cat 21, Ed0.23 does not directly support DO260B;
- b) The same techniques used for processing DO260A can be used for processing DO260B, however, the table used must account for NIC supplement B & NIC supplement C, and may also wish to account for SDA; and
- c) If there is a particular need for the ATC system to have access to the new data items offered by DO260B, then users may need to consider a more recent version of Cat 21 (e.g. Ed2.1 or later versions).

10.2 Support of DO260B using Asterix Cat 21 Ed2.1 or later versions

- a) If DO260B is used, then the ANSP could decide to use Asterix Cat 21 Ed2.1 or later; and
- b) Readers are invited to carefully examine the DO260B data items (see Appendix D)

to determine if the benefits of additional DO260B data items are large enough to warrant adoption of Asterix Cat 21 Version 2.1 or later.

11. ADS-B FORMAT CONVERSION AND FILTER SYSTEM

11.1 It is clear that the evolution of 1090ES ADS-B transmission will continue. Avionics software will be upgraded to provide additional or changed functionality. As a result Asterix standards will also continue to evolve, and ATC systems will need to be adaptable to be able to cope with new functionality requirements and new message standards.

11.2 The use of an ADS-B format conversion & filter (ADS-B FC&F) system between domestic ADS-B systems and data shared with other states is a cost-effective way to provide the necessary protection and flexibility in this evolution. Such a system provides ADS-B format conversion between domestic and foreign ADS-B systems. While decoupling one ADS-B Asterix environment from another, the system allows information that meets specific sharing criteria to be passed through for data sharing. By doing so, loading on the ATM automation systems to process ADS-B data and bandwidth requires to transmit the ADS-B data could then be reduced. The system also allows independent domestic format changes without disruption to the foreign environment. A typical structure could be as shown below:

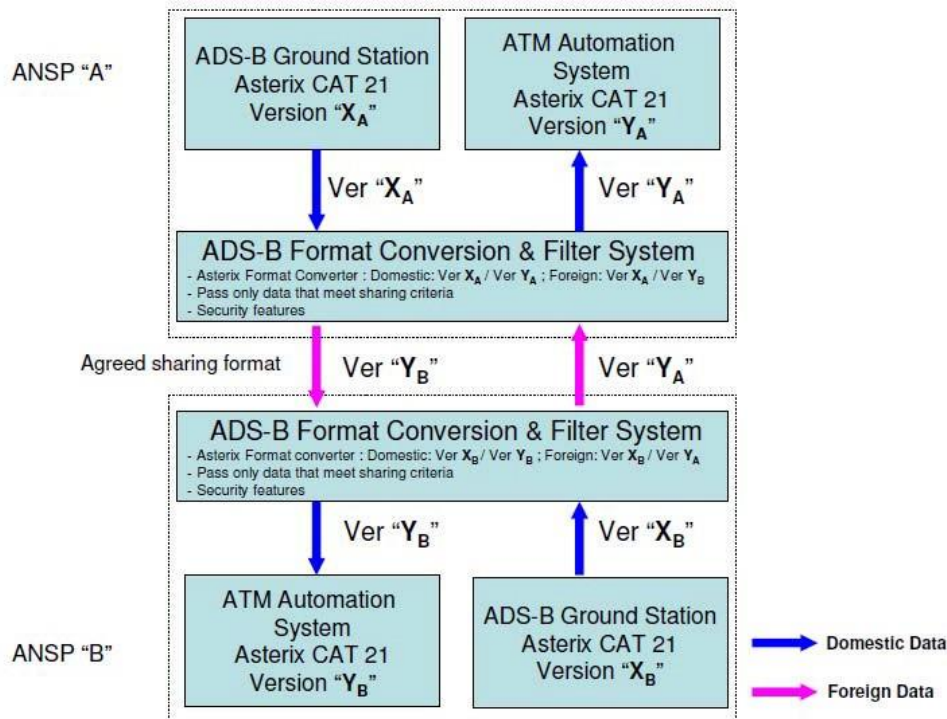

7 Attachment A - Group 1 (Mandatory Data Items)

Data Items	Description	Ed 0.23	Ed 2.1	Remarks
I021/010	Data Source Identification	X	X	Identifies source of data. Important if validity checks are performed as an anti spoofing capability. Validation that the data is received from an approved ADS-B receiver station. Data received from a receiver station should not be processed if the position of the reported aircraft is an unreasonable distance away from the known location of the ADS-B receiver station. Where space based ADS-B is used and a nominal station location is defined, such range processing limits will need to account for the coverage supplied.
I021/030	Time of Day	X		Necessary to extrapolate the ADS-B data to time of display. Data received with a Time of Day too far in the past should be discarded. This data is too old.
I021/071 or I021/073	Time of Applicability of Position or Time of Message reception for position		X	Necessary to extrapolate the ADS-B data to time of display. Data received with a Time of Day too far in the past should be discarded. This data is too old.
I021/040	Target Report Descriptor	X	X	Indicates if report is a duplicate, on the receiver, is a simulated target, is a test target. This needs to be checked by ATC system prior to processing. If the data indicates that the report is a test target or a simulated target, it is normally processed differently to “real” targets.
I021/080	Target Address	X	X	Included in all 1090ES downlink messages, so always available. Used for report/report linkage in ATC tracking.
I021/090	Figure of Merit/Quality Indicators	X	X	Position cannot be used without quality indicator. If the quality of the positional data does not meet the requirements the data should be discarded.
I021/130	Position in WGS-84 co-ordinates	X	X	Report cannot be used without position

Attachment B - Group 2 (Desirable Data Items)

Data Items	Description	Ed 0.23	Ed 2.1	Remarks
I021/008	Aircraft operational status		X	TCAS capability, Target state reporting capability, CDTI capability, Single/dual aircraft antenna. It is desirable to have immediate knowledge of RA event.
I021/020	Emitter Category	X	X	Aircraft or vehicle type
I021/140	Geometric Altitude/Height	X	X	Useful for RVSM monitoring. Not normally used for ATC application. Could perhaps be used as an indicator of correct QNH setting in aircraft.
I021/145	Flight Level	X	X	Flight level is an important information to ATC
I021/155	Barometric Vertical Rate	X	X	Used for predictive tools and safety nets. Either Barometric vertical rate or Geometric vertical rate is provided by the aircraft – not both. However, the ATC system can calculate vertical rate from multiple flight level reports if these data items are not available.
I021/157	Geometric Vertical Rate	X	X	
I021/160	Ground Vector	X	X	Provides excellent vector to support extrapolation of positional data to time of display. However, the ATC system can calculate the velocity vector (ground vector) from multiple position reports. I021/160 however, is normally far superior that ATC system calculation.
I021/170	Target Identification	X	X	This is the callsign/Flight ID is extremely useful for ATC and matching to the flight plan (if any). Target identification is only sent once per 5 seconds. Some receiver stations designs attach the target identification (if known from previous recent downlinks) even if not received in the last 5 seconds. The field can be missing at the edge of ADS-B coverage – for flights inbound to coverage.
I021/200	Target Status	X	X	This is the emergency type and is highly desirable.

Attachment C - Group 3 (Optional Data Items)

Data Items	Description	Ed 0.23	Ed 2.1	Remarks
I021/077	Time of report transmission		X	Time of applicability is relevant for ATC system processing. Time of transmission is less relevant.
I021/032	Time of Day Accuracy	X		Maximum error in Time of day. Normally the maximum value is known by the ANSP because of station design.
I021/095	Velocity Accuracy	X		If using GPS, velocity accuracy will be adequate if the Position quality is accurate.
I021/072	Time of applicability of velocity		X	Can be managed by a velocity data time out in receiver station.
I021/075	Time of message reception of velocity		X	Normally velocity is in the same Asterix message as position. Velocity data time out in receiver station.
I021/161	Track number		X	Tracking can be performed by ATC system. Also the 24 bit code (aircraft address) could be used as a pseudo track number.
I021/110	Trajectory Intent	X	X	Defined in DO260 but not transmitted by any known product. Not defined in DO260A or DO260B
I021/146	(Intermediate) Selected Altitude	X	X	Target altitude :
I021/148	Final State Selected Altitude	X	X	Information from DO260A/B Target state and status messages (On condition messages). These could be used for detection of pilot errors in selection of heading/altitude.
I021/015	Service identification		X	Type of Service (VDL4, Ext Squitter, UAT, TIS-B VDL4, TIS-B Ext Squitter, TIS-B UAT, FIS-B VDL4, GRAS VDL4, MLT). Not useful to most ATC systems.
I021/016	Service management		X	Update rate or whether data driven output from GS. Normally known by receiver.

Data Items	Description	Ed 0.23	Ed 2.1	Remarks
I021/074	Time of message reception of position – high resolution		X	High resolution is designed to support MLAT system processing by receiver. Not required for pure ADS-B.
I021/076	Time of message reception of velocity – high resolution		X	High resolution is designed to support MLAT system processing by receiver. Not required for pure ADS-B.
I021/210	MOPS version/ Link Technology Indicator	X	X	Maybe useful for statistics about equipage. Not operationally relevant
I021/070	Mode 3/A code		X	Could be used for legacy ATC system that do not use Flight ID
I021/165	Rate of Turn/Track Angle rate	X	X	Not transmitted in DO260, DO260A or DO260B messages
I021/271	Surface capabilities and characteristics		X	
I021/132	Message amplitude		X	Useful for technical analysis. Not operationally relevant
I021/250	Mode S MB data		X	
I021/260	ACAS resolution advisory report		X	
I021/400	Receiver ID		X	
I021/295	Data ages		X	
I021/150	Air Speed	X	X	Defined in standards but only sent in absence
I021/151	True Air Speed	X	X	Ground vector information. Can't be used for extrapolation unless wind speed known.
I021/152	Magnetic Heading	X	X	Defined in standards but only sent in absence Ground vector information.
I021/220	Met Report	X	X	Not transmitted in DO260, DO260A or DO260B messages
I021/230	Roll Angle	X	X	Not transmitted in DO260, DO260A or DO260B messages
I021/131	Position in WGS-84 coordinates, high resolution		X	

Attachment D - Differences among DO260, DO260A, DO260B

	DO-260	DO-260A	DO-260B	Availability of data in Asterix CAT 21	Potential uses of additional information
Introduction of Navigation Integrity Category (NIC) to replace Navigation Uncertainty Category (NUC _P)	NUC _P is used.	NIC is used to replace NUC _P .	More levels of NIC available. Vertical component removed.	NIC is shown in Ed1.0 and above. More levels of NIC (shown as PIC) are available in v2.1.	The additional quantum levels of NIC would allow the ANSP more flexibility in deciding whether the NIC is considered as ‘good’ (if required) However, for 3 NM & 5 NM separation with HPL 1Nm and 2 Nm respectively, this additional quantum is not useful.
Quality Indicator for Velocity (NUC _R and NAC _V)	NUC _R is used.	Replaced with NAC _V . Definition remains the same.	Vertical component removed.	Available in Ed0.23 and above.	Vertical component is not available for DO260B.
Surveillance Integrity Level and Source Integrity Level (SIL)	Not available.	Surveillance Integrity Level is used.	Renamed as Source Integrity Level. Definition is changed to exclude avionics fault.	Available in Ed1.0 and above.	The SIL will allow the user to further assess the integrity of the reported position (if required). NB: An implied SIL exists for DO260 aircraft if they always use GPS. However DO260 aircraft do not provide SIL.
System Design Assurance (SDA)	Not available.	Not available.	To address probability of avionics fault.	Available in Ed2.1.	The SDA will indicate the robustness of the system. ANSPs may decide on a minimum SDA for ADS-B services. If this action is taken then DO260 and DO260A aircraft will be unable to meet the criteria.

ADS-B Implementation and Operations Guidance Document

	DO-260	DO-260A	DO-260B	Availability of data in Asterix CAT 21	Potential uses of additional information
Navigation Accuracy Category (NAC _P)	Not available.	Derived from HFOM and VFOM.	Relies only on HFOM.	Available in Ed1.0 and above.	A reported accuracy is not provided by DO260. However, an estimated accuracy can be derived from NUC – assuming that NUC is HPL based.
Geometric Vertical Accuracy (GVA)	Not available.	Not available.	Derived from VFOM.	Available in Ed2.1.	Geometric altitude accuracy is not normally required for operational purposes.
Barometric Altitude Integrity Code (NIC _{BARO})	Not available.	To indicate integrity of barometric altitude.	Same as DO-260A	Available in Ed1.0 and above.	The NIC _{BARO} indicates the integrity of the barometric height. ANSPs could indicate to the controller that Barometric data has not been verified, however, aircraft without dual barometric systems/air data computers may be unable to provide a non zero NIC _{BARO} as data could be unnecessarily discarded.
Length / Width of Aircraft	Not available.	Provide an indication of aircraft size.	Same as DO-260A	Available in Ed1.0 and above.	The width / length indicate the size of the aircraft. This information may be used as an input for generating alerts on airport surface movement control.

ADS-B Implementation and Operations Guidance Document

	DO-260	DO-260A	DO-260B	Availability of data in Asterix CAT 21	Potential uses of additional information
Indication of capabilities	Only show status of TCAS and CDTI.	More information available including capability to send Air Reference Velocity, Target State and Trajectory Change reports. Status of Identity Switch.	Additional information on type of ADS-B in (i.e. 1090ES in or UAT in).	Available in Ed1.0 and above, except availability of 1090ES/UAT in and information on GPS antenna offset.	Indication on the availability of 1090ES in / UAT in may allow the controller to anticipate a potential request for in-trail procedure clearance. NB: ITP requires decision support aids which are more complex than ADS-B IN alone.
Status of Resolution Advisory	Not available.	Information on whether Resolution Advisory is active.	Same as DO-260A	Available in Ed1.0 and above,	Indication of the resolution advisory status allows the controller to know whether the pilots were alerted about the potential conflict.
GPS offset	Not available.	Indication on whether GPS offset is applied.	Information on GPS antenna offset is provided.	GPS offset status is available in Ed1.0 and above. Information on GPS offset is not available in ASTERIX	Indication on GPS offset may be one of the inputs for generating alerts on airport surface movement control.
Intention	Not available.	Able to indicate intended altitude and heading.	Same as DO-260A	Intended altitude is available in Ed0.23. Intended heading is not available in ASTERIX.	The intended heading and flight level can be used as an input to the trajectory prediction algorithm in the Short-Term Conflict Alert.

ADS-B Implementation and Operations Guidance Document

	DO-260	DO-260A	DO-260B	Availability of data in Asterix CAT 21	Potential uses of additional information
Target Status	Not available.	Not available.	Indication of Autopilot mode, Vertical Navigation mode, Altitude Hold mode, Approach Mode and LNAV Mode.	Vertical Navigation mode, Altitude Hold mode and Approach Mode are available in Ed 0.23 and above LNAV Mode is available in Ed2.1	The target status allows the controller to know the mode that the aircraft is in. i.e.: It could be presented to ATC.
Resolution Advisory	Not available.	Not available.	Availability of Active Resolution Advisories; Resolution Advisory complement record, Resolution Terminated; Multiple Threat encounter; Threat Type indicator; and Threat Identity data.	Available in Ed1.0 and above.	The Resolution Advisory will help the controller know the advisories that are provided to the pilots by the ACAS. This helps prevent the controller from giving instructions that are in conflict with the ACAS.

	DO-260	DO-260A	DO-260B	Availability of data in Asterix CAT 21	Potential uses of additional information
Mode A	DO260 change 1, allows this using test message in USA only. This was not implemented in actual products.	Broadcasted using test message in USA only.	Broadcasted worldwide as a regular message.	Available in Ed0.26 and above.	The Mode A allows flight plans to be coupled with the ADS-B tracks (supports legacy ATM automation system).
