



Global Operational Data Link Document (GOLD)

This edition has been issued by the GOLD ad hoc Working Group for the Asia/Pacific Air Navigation Planning and Implementation Regional Group (APANPIRG), the North Atlantic Systems Planning Group (NAT SPG), the European Air Navigation Planning Group (EANPG), the South American Region Implementation Group (SAM/IG) and the African-Indian Ocean Planning and Implementation Regional Group (APIRG).

Second Edition — 26 April 2013

International Civil Aviation Organization

This document is available by accessing any of the following ICAO regional websites.

Asia and Pacific (APAC) Office	http://www.icao.int/apac
Eastern and Southern African (ESAF) Office	www.icao.int/esaf
European and North Atlantic (EUR/NAT) Office	http://www.paris.icao.int
Middle East (MID) Office	www.icao.int/mid
North American, Central American and Caribbean (NACC) Office	http://www.mexico.icao.int
South American (SAM) Office	http://www.lima.icao.int
Western and Central African (WACAF) Office	http://www.icao.int/wacaf

For more information, contact the ICAO regional office.



Global Operational Data Link Document (GOLD)

This edition has been issued by the GOLD ad hoc Working Group for the Asia/Pacific Air Navigation Planning and Implementation Regional Group (APANPIRG), the North Atlantic Systems Planning Group (NAT SPG), the European Air Navigation Planning Group (EANPG), the South American Region Implementation Group (SAM/IG) and the African-Indian Ocean Planning and Implementation Regional Group (APIRG).

Second Edition — 26 April 2013

International Civil Aviation Organization

Table of Contents

	<i>Page</i>
FOREWORD	xv
Chapter 1. Definitions	1-1
1.1 Terms and definitions	1-1
1.2 Acronyms.....	1-13
Chapter 2. Overview of data link operations	2-1
2.1 Data link operational capabilities	2-1
2.1.1 Data link benefits.....	2-1
2.1.2 Data link systems – interoperability standards	2-2
2.1.3 Data link services – safety and performance specifications	2-7
2.1.3.1 Oceanic SPR Standard (RTCA DO-306/EUROCAE ED-122)	2-7
2.1.3.2 Continental SPR Standard (RTCA DO-290/EUROCAE ED-120).....	2-9
2.1.3.3 Performance-based communication and surveillance (PBCS).....	2-9
2.1.4 Airspace types and their data link operational capabilities.....	2-10
2.1.4.1 Airspace where procedural separation is being applied.....	2-10
2.1.4.2 Airspace where ATS surveillance services are provided.....	2-11
2.1.4.3 Global overview of data link operational capabilities.....	2-11
2.2 Data link systems and services	2-13
2.2.1 Network descriptions and message acknowledgements	2-13
2.2.1.1 ACARS network and message acknowledgement.....	2-13
2.2.1.2 ATN network and message acknowledgement.....	2-14
2.2.2 Data link messages	2-15
2.2.3 Data link initiation capability (DLIC)	2-19
2.2.3.1 Purpose of the logon (flight plan correlation).....	2-19
2.2.3.2 Initial logon request	2-21
2.2.3.3 Logon response	2-22
2.2.3.4 Logon request triggered by contact request	2-22
2.2.4 CPDLC connection management	2-24
2.2.4.1 Purpose of a CPDLC connection	2-24
2.2.4.2 Active and inactive CPDLC connections.....	2-24
2.2.4.3 Establishing a CPDLC connection.....	2-24
2.2.4.4 Terminating a CPDLC connection (termination request message).....	2-26
2.2.4.5 Transferring CPDLC connections.....	2-27
2.2.4.6 The CPDLC connection sequence	2-29
2.2.4.7 Determining an active CPDLC connection.....	2-33
2.2.4.8 Non-standard events associated with CPDLC transfers.....	2-34
2.2.5 Controller-pilot data link communications (CPDLC)	2-39
2.2.5.1 CPDLC - general.....	2-39
2.2.5.2 CPDLC message set.....	2-39
2.2.5.3 CPDLC messages.....	2-40
2.2.5.4 Responses to CPDLC messages.....	2-41
2.2.5.5 Open and closed CPDLC messages	2-42

2.2.5.6	CPDLC dialogues	2-43
2.2.5.7	Message identification numbers (MIN)	2-44
2.2.5.8	Message reference numbers (MRN)	2-44
2.2.6	Automatic dependent surveillance – contract (ADS-C)	2-46
2.2.6.1	ADS-C – general	2-46
2.2.6.3	ADS contract	2-46
2.2.6.4	ADS-C report	2-55
2.2.6.5	Contents of ADS-C groups	2-59
2.2.6.6	Using ADS-C reports	2-59
2.2.7	FMC WPR data link system	2-64
2.2.7.1	FMC WPR - general	2-64
2.2.7.2	Description	2-65
2.2.7.3	Position report - description	2-65
Chapter 3. Administrative provisions related to data link operations.....		3-1
3.1	ANSP service provision.....	3-1
3.1.1	ANSP system validation	3-1
3.1.2	ATC automated data link functions	3-3
3.1.2.1	Logon request	3-3
3.1.2.2	Transfers between FANS 1/A and ATN B1 adjacent ATSU's	3-3
3.1.2.3	CPDLC and ADS-C connection management	3-6
3.1.2.4	Emergency message element handling	3-6
3.1.2.5	Automated responses	3-6
3.1.2.6	Message latency monitor	3-7
3.1.2.7	Abnormal cases with ADS-C	3-8
3.1.2.8	Satcom channel numbers in CPDLC messages	3-8
3.1.3	Contractual considerations for CSP	3-8
3.1.4	Aeronautical information, notifications, and interfacility agreements	3-9
3.1.5	Monitoring and data recording	3-11
3.2	Operator eligibility.....	3-11
3.2.1	Operational authorization to use data link	3-11
3.2.2	Regional/State monitoring agencies	3-13
3.3	Flight planning.....	3-13
3.3.1	General.....	3-13
3.3.2	CPDLC and ADS-C.....	3-14
3.3.3	FMC WPR	3-15
3.4	FMC WPR – additional guidance.....	3-15
Chapter 4. Controller and radio operator procedures.....		4-1
4.1	Overview	4-1
4.1.1	General.....	4-1
4.1.2	When to use voice and when to use CPDLC	4-1
4.2	CPDLC connection management and voice communication transfers.....	4-2
4.2.1	General.....	4-2
4.2.2	Establish CPDLC connection	4-2
4.2.3	Transfer voice communications with CPDLC connection transfer	4-3
4.2.4	Termination of the CPDLC connection	4-5
4.2.5	CPDLC connection with aircraft transiting small data link area	4-5

4.3	CPDLC – Uplink messages	4-8
4.3.1	General.....	4-8
4.3.2	Use of free text	4-9
4.3.3	“EXPECT” uplink messages	4-9
4.3.4	Vertical clearances.....	4-11
4.3.5	Report/confirmation requests.....	4-13
4.3.6	Creating multi-element uplink messages.....	4-14
4.3.7	Weather deviations	4-15
4.4	CPDLC – Downlinks.....	4-16
4.4.1	General.....	4-16
4.4.2	Clarifying a downlink message	4-16
4.4.3	Responses/acknowledgements.....	4-16
4.4.4	Responding to multi-element requests.....	4-18
4.4.5	Offering alternative clearances to requests.....	4-19
4.5	ADS-C	4-20
4.5.1	General.....	4-20
4.5.2	ADS contracts.....	4-21
4.5.3	ADS-C connection management	4-22
4.5.4	ADS contract - periodic.....	4-24
4.5.5	ADS contract - waypoint change event	4-25
4.5.6	ADS contract - vertical range change and lateral deviation events	4-25
4.6	Separation	4-25
4.6.1	General – ADS-C.....	4-25
4.6.2	Vertical separation –ADS-C	4-26
4.6.3	Lateral separation – ADS-C.....	4-26
4.6.4	Longitudinal separation – ADS-C	4-27
4.6.5	Using FMC WPR for position reporting	4-28
4.7	Alerting service.....	4-28
4.8	Emergency procedures.....	4-28
4.8.1	General.....	4-28
4.8.2	CPDLC and ADS-C emergency	4-28
4.8.3	ADS-C emergency report without a CPDLC emergency message	4-29
4.9	Non-routine procedures	4-30
4.9.1	General.....	4-30
4.9.2	Voice communications related to data link	4-30
4.9.3	Data link initiation failure.....	4-32
4.9.4	Data link service failures	4-32
4.9.4.1	CPDLC connection failure.....	4-32
4.9.4.2	Transferring the CPDLC connection – abnormal conditions.....	4-33
4.9.4.3	Data link service failure	4-33
4.9.4.4	Planned data link shutdown	4-33
4.9.4.5	CPDLC or ADS-C service failure.....	4-34
4.9.4.6	Resuming data link operations.....	4-34
4.9.4.7	Inaccurate time estimates	4-35
4.9.4.8	SATCOM failure	4-35
4.9.5	Using CPDLC to relay messages.....	4-35
Chapter 5.	Flight crew procedures	5-1
5.1	Overview	5-1

5.1.1	General.....	5-1
5.1.2	Operational differences between voice communications and CPDLC.....	5-1
5.1.3	When to use voice and when to use CPDLC.....	5-2
5.2	Logon.....	5-3
5.2.1	General.....	5-3
5.2.2	When to log on initially for data link services.....	5-7
5.2.3	Automatic transfer of CPDLC and ADS-C services between ATSUs.....	5-7
5.2.4	Transfer voice communications with the CPDLC connection transfer.....	5-7
5.2.5	Exiting CPDLC and ADS-C service areas.....	5-8
5.3	CPDLC – ATS uplink messages.....	5-8
5.3.1	General.....	5-8
5.3.2	Flight crew response times for CPDLC uplink messages.....	5-10
5.3.3	Conditional clearances.....	5-11
5.3.4	“EXPECT” uplink messages.....	5-12
5.3.5	Uplinks containing FMS-loadable data.....	5-13
5.4	CPDLC – ATS downlink messages.....	5-14
5.4.1	General.....	5-14
5.4.2	Free text.....	5-15
5.4.3	Unsupported messages.....	5-15
5.4.4	CPDLC reports and confirmation requests.....	5-15
5.5	Automatic dependant surveillance – contract (ADS-C).....	5-16
5.5.1	General.....	5-16
5.6	Position reporting.....	5-16
5.6.1	General.....	5-16
5.6.2	Position reporting in a non-ADS-C environment.....	5-17
5.6.3	Position reporting in an ADS-C environment.....	5-17
5.6.4	Position reporting using FMC WPR.....	5-18
5.7	Weather deviations and offsets.....	5-19
5.7.1	General.....	5-19
5.7.2	Weather deviation requests and offsets.....	5-19
5.7.3	Deviations either side of route.....	5-22
5.7.4	Reporting back on route.....	5-23
5.8	Emergency procedures.....	5-23
5.8.1	General.....	5-23
5.8.2	CPDLC and ADS-C emergency.....	5-23
5.9	Non-routine procedures.....	5-24
5.9.1	General.....	5-24
5.9.2	Voice communications related to data link.....	5-24
5.9.3	Data link initiation failure.....	5-25
5.9.4	Data link system failures.....	5-26
5.9.5	Using CPDLC to relay messages.....	5-27
Chapter 6. Advanced air traffic services supported by data link.....		6-1
6.1	Re-route procedures.....	6-1
6.1.1	General.....	6-1
6.1.2	Re-route procedures – AOC initiated (DARP).....	6-1
6.1.3	Re-route procedures – ATC initiated.....	6-4
6.2	Tailored arrival (TA).....	6-11
6.2.1	General.....	6-11

6.2.2	Provisions for the TA service	6-12
6.2.3	Clearance delivery and execution	6-12
6.3	Automatic dependent surveillance – broadcast in-trail procedure (ADS-B ITP)	6-16
6.3.1	General.....	6-16
6.3.2	Provisions for the ADS-B ITP service and operator eligibility	6-17
6.3.3	Clearance delivery and execution	6-17
Chapter 7.	State aircraft data link operations.....	7-1
7.1	General.....	7-1
7.2	Military assumes responsibility for separation of aircraft (MARSA)	7-1
7.3	Air-to-air refueling (AAR)	7-2
7.4	Formation flight data link procedures.....	7-7
7.5	ADS-C reports	7-9

List of Figures

Figure 2-1.	Overview of a data link system	2-2
Figure 2-2.	Different ATSU/aircraft interoperable connectivity.....	2-3
Figure 2-3.	Uplink and message assurance	2-13
Figure 2-4.	Downlink and network acknowledgement	2-14
Figure 2-5.	Uplink and logical acknowledgement	2-15
Figure 2-6.	Downlink and logical acknowledgement	2-15
Figure 2-7.	Initial logon exchanges.....	2-22
Figure 2-8.	Air-ground address forwarding message sequence (Transfer between areas where data link is provided).....	2-23
Figure 2-9.	Ground-ground address forwarding using logon forwarding message.....	2-24
Figure 2-10.	CPDLC connection sequence.....	2-25
Figure 2-11.	Successful attempt to establish a CPDLC connection (inactive).....	2-26
Figure 2-12.	Termination of the CPDLC connection.....	2-27
Figure 2-13.	Next data authority notification.....	2-28
Figure 2-14.	Connection forwarding.....	2-29
Figure 2-15.	Life cycle of the CPDLC connection process	2-30
Figure 2-16.	Nominal sequence for initial CPDLC connection establishment and transfer of CPDLC connection using air-ground address forwarding.....	2-31
Figure 2-17.	Nominal sequence for initial CPDLC connection establishment and transfer of CPDLC connection using ground-ground address forwarding (no use of Next Authority Notified).....	2-32
Figure 2-18.	Nominal sequence for initial CPDLC connection establishment and transfer of CPDLC connection using ground-ground address forwarding (use of Next Authority Notified).....	2-33
Figure 2-19.	Rejection of CPDLC uplinks from the NDA.....	2-34
Figure 2-20.	Depiction of the change in route of an aircraft.....	2-35
Figure 2-21.	Sending a new NDA following a re-route	2-36
Figure 2-22.	Non-receipt of the NDA message.....	2-37
Figure 2-23.	Connection request from an ATSU not designated as the NDA	2-37
Figure 2-24.	Successful CPDLC connection following a re-send of the NDA message	2-38
Figure 2-25.	Disconnection of both active and inactive connections.....	2-39

Figure 2-26.	Message/dialogue status for CPDLC request and clearance exchange	2-43
Figure 2-27.	Message/dialogue status for CPDLC confirmation request and report exchange	2-44
Figure 2-28.	ADS-C periodic contract sequence.....	2-47
Figure 2-29.	ADS-C emergency and non-emergency report sequence.....	2-49
Figure 2-30.	ADS-C event contract sequence.....	2-50
Figure 2-31.	ADS-C waypoint change event	2-50
Figure 2-32.	ADS-C level range deviation event.....	2-51
Figure 2-33.	ADS-C level range deviation event report	2-52
Figure 2-34.	ADS-C lateral deviation event.....	2-52
Figure 2-35.	ADS-C lateral deviation event report.....	2-53
Figure 2-36.	Effect of offset on ADS-C lateral deviation event report.....	2-53
Figure 2-37.	No lateral deviation event report if active route is different to route held by ATSU	2-54
Figure 2-38.	ADS-C basic group.....	2-56
Figure 2-39.	ADS-C flight identification group.....	2-56
Figure 2-40.	ADS-C Earth reference group	2-56
Figure 2-41.	ADS-C air reference group.....	2-57
Figure 2-42.	ADS-C airframe identification group.....	2-57
Figure 2-43.	ADS-C meteorological group.....	2-57
Figure 2-44.	ADS-C predicted route group.....	2-58
Figure 2-45.	ADS-C fixed projected intent group.....	2-58
Figure 2-46.	ADS-C intermediate projected intent group.....	2-59
Figure 2-47.	Multiple ADS periodic contracts with different groups	2-61
Figure 2-48.	Multiple ADS periodic contracts with different reporting intervals.....	2-61
Figure 2-49.	Multiple and different ADS event contracts.....	2-62
Figure 2-50.	Calculation of ADS-C periodic reporting interval	2-64
Figure 4-1.	CPDLC connection transfer - separate messages	4-4
Figure 4-2.	Transiting small data link area	4-7
Figure 4-3.	Priorities for ADS-C connections.....	4-23
Figure 4-4.	ADS-C connection not available due to congestion.....	4-24
Figure 5-1.	Depiction of logon addresses and CPDLC/ADS-C services on en route chart	5-5
Figure 5-2.	Waypoint sequencing anomaly.....	5-17
Figure 5-3.	Offset and weather deviation.....	5-19
Figure 5-4.	Weather deviation clearance up to 20 NM left of route	5-20
Figure 5-5.	Subsequent weather deviation clearance up to 50 NM left of route.....	5-21
Figure 5-6.	Subsequent weather deviation clearance up to 30 NM right of route.....	5-22
Figure 6-1.	The DARP process	6-4
Figure 6-2.	ATC initiated re-route – first waypoint in the new route is on the current route and there is no route discontinuity	6-7
Figure 6-3.	ATC initiated re-route – first waypoint in the new route is on the current route and there is route discontinuity	6-8
Figure 6-4.	ATC initiated re-route – first waypoint in the new route is not on the current route and there is no route discontinuity.....	6-9
Figure 6-5.	ATC initiated re-route – first waypoint in the new route is not on the current route and there is route discontinuity.....	6-10
Figure 6-6.	ATC initiated re-route – aircraft is cleared direct to a fix that is located downstream in the current route.....	6-11
Figure 7-1.	Air refueling pattern	7-3

List of Tables

Table 2-1.	Designators for aircraft and ATSU (ground) data link systems	2-4
Table 2-2.	Designators for subnetworks	2-7
Table 2-3.	Examples of applying RCP specifications to intended uses	2-8
Table 2-4.	Examples of applying RSP specifications to intended uses	2-8
Table 2-5.	Types of data link systems and operations	2-12
Table 2-6.	Air-ground data link messages for DLIC	2-16
Table 2-7.	Ground-ground data link messages for DLIC	2-16
Table 2-8.	Data link messages for CPDLC connection	2-17
Table 2-9.	Examples of responses to CPDLC uplink messages	2-40
Table 2-10.	Precedence of responses	2-41
Table 2-11.	Examples of multi-element CPDLC uplink messages	2-42
Table 2-12.	Example of CPDLC dialogue	2-45
Table 2-13.	Figure of merit values	2-63
Table 3-1.	Supporting technology for transfers between FANS 1/A and ATN B1	3-3
Table 3-2.	Descriptors for CPDLC/ADS-C equipment and capabilities in Item 10	3-14
Table 4-1.	CONTACT/MONITOR message elements	4-4
Table 4-2.	“EXPECT” uplink message elements for flight crew requests	4-9
Table 4-3.	Procedural “EXPECT” uplink message elements	4-10
Table 4-4.	Conditional vertical clearances applicable during flight maneuver	4-11
Table 4-5.	ADS-C out-of-conformance messages	4-14
Table 4-6.	Voice phraseology related to CPDLC	4-31
Table 5-1.	Messages and indications regarding use of message latency monitor	5-6
Table 5-2.	Conditional clearance clarification of vertical clearances	5-11
Table 5-3.	Voice phraseology related to CPDLC	5-25
Table 6-1.	AOC initiated re-route procedures	6-2
Table 6-2.	ATC initiated re-route procedures	6-6
Table 6-3.	Tailored arrival clearance delivery and execution	6-13
Table 6-4.	ADS-B ITP clearance delivery and execution	6-18
Table 7-1.	MARSA initiation and termination procedures	7-2
Table 7-2.	Air refueling data link procedures	7-3
Table 7-3.	Single aircraft or formation joining an ALTRV data link procedures	7-8
Table 7-4.	Formation break-up or departure from ALTRV data link procedures	7-8

Appendices

Appendix A	CPDLC message elements and standardized free text messages	1
A.1	General	1
A.2	CPDLC message element response requirements key	3
A.3	CPDLC uplink message elements	4
A.4	CPDLC downlink message elements	32
A.5	CPDLC standardized free text messages	46
A.5.1	CPDLC standardized free text uplink messages	46
A.5.2	CPDLC standardized free text downlink messages	52

Appendix B	RCP specifications	1
B.1	General.....	1
B.2	Terms and acronyms.....	1
B.3	RCP 240 specification	6
B.3.1	RCP 240/D allocations	6
B.3.1.1	General.....	6
B.3.1.2	Air navigation service provider (ANSP).....	7
B.3.1.3	Communication service provider (CSP).....	10
B.3.1.4	Aircraft system.....	12
B.3.1.5	Aircraft operator.....	15
B.4	RCP 400 specification	17
B.4.1	RCP 400/D allocations	17
B.4.1.1	General.....	17
B.4.1.2	Air navigation service provider (ANSP).....	18
B.4.1.3	Communication service provider (CSP).....	19
B.4.1.4	Aircraft system.....	20
B.4.1.5	Aircraft operator.....	22
Appendix C	RSP specifications.....	1
C.1	General.....	1
C.2	Terms and acronyms.....	1
C.3	RSP 180 specification.....	5
C.3.1	RSP 180/D allocations.....	6
C.3.1.1	General.....	6
C.3.1.2	Air navigation service provider (ANSP).....	6
C.3.1.3	Communication service provider (CSP).....	8
C.3.1.4	Aircraft system.....	9
C.3.1.5	Aircraft operator.....	11
C.4	RSP 400 specification.....	13
C.4.1	RSP 400/D allocations.....	14
C.4.1.1	General.....	14
C.4.1.2	Air navigation service provider (ANSP).....	14
C.4.1.3	Communication service provider (CSP).....	14
C.4.1.4	Aircraft system.....	16
C.4.1.5	Aircraft operator.....	16
Appendix D	Post-implementation monitoring and corrective action.....	1
D.1	General.....	1
D.2	ANSP data collection and analysis.....	2
D.2.1	General.....	2
D.2.2	ANSP data collection for CPDLC application	3
D.2.2.1	General.....	3
D.2.2.2	Measuring CPDLC communication performance.....	3
D.2.2.3	Recording the data points for each CPDLC transaction	8
D.2.2.4	Data record for each CPDLC transaction	12
D.2.3	ANSP data collection for ADS-C application	12
D.2.3.1	General.....	12
D.2.3.2	Measuring actual surveillance performance (ASP).....	12

	D.2.3.3	Recording the ADS-C data points for each ADS-C downlink.....	12
	D.2.3.4	Data record for each ADS-C downlink.....	14
D.2.4		ANSP data analysis	14
	D.2.4.1	General.....	14
	D.2.4.2	Graphical analysis.....	15
	D.2.4.3	Data filtering.....	16
	D.2.4.4	CPDLC performance analysis.....	17
	D.2.4.5	ADS-C surveillance data transit time analysis.....	23
	D.2.4.6	Identifying poor performers.....	28
	D.2.4.7	Assessing periodic monitoring results	29
D.3		Problem reporting and resolution	32
	D.3.1	General.....	32
	D.3.2	Problem report form	33
	D.3.3	Problem assessment.....	36
		D.3.3.1 Data collection	36
		D.3.3.2 Data analysis.....	36
	D.3.4	Mitigating procedures – problem resolution.....	37
D.4		Regional performance monitoring.....	37
	D.4.1	General.....	37
	D.4.2	Reporting on availability	37
	D.4.3	Reporting on CPDLC actual communications performance	39
	D.4.4	Reporting on RSP data transit time	40
	D.4.5	Reporting data to enable graphical reports	42

Appendix E Regional/State-specific information 1

E.1		General.....	1
E.2		Africa-Indian Ocean (AFI) Region.....	1
	E.2.1	Administrative provisions related to data link operations	1
	E.2.2	Controller and radio operator procedures	2
	E.2.3	Flight crew procedures	2
	E.2.4	Advanced data link operations.....	2
	E.2.5	State aircraft data link operation.....	2
E.3		Caribbean (CAR) Region	2
	E.3.1	Administrative provisions related to data link operations	2
	E.3.2	Controller and radio operator procedures	3
	E.3.3	Flight crew procedures	4
	E.3.4	Advanced data link operations.....	4
	E.3.5	State aircraft data link operation.....	4
E.4		European (EUR) Region.....	4
	E.4.1	Administrative provisions related to data link operations	4
		E.4.1.1 ANSP service provision.....	4
		E.4.1.2 EUR - NSAP address registry.....	7
		E.4.1.3 Flight plan provisions	8
		E.4.1.4 Logon criteria.....	8
		E.4.1.5 Lack Timer.....	8
	E.4.2	Controller procedures	8
		E.4.2.1 Reverting from CPDLC to voice	8
		E.4.2.2 Preconditions for the operational exchange of CPDLC messages.....	9
		E.4.2.3 Uplink messages	9

	E.4.2.4	Operational timers used by ATSU	12
	E.4.2.5	Transfer of data communications with open dialogues.....	12
	E.4.2.6	Abnormal situations	13
	E.4.2.7	Downlink error messages.....	14
E.4.3		Flight crew procedures	16
	E.4.3.1	General.....	16
	E.4.3.2	Latency time monitor (LTM).....	18
	E.4.3.3	Operational use of LACK	18
	E.4.3.4	Operational timers used by the aircraft.....	19
	E.4.3.5	Use of degrees in ACL messages.....	19
	E.4.3.6	Transfer of data communications with open dialogues.....	20
	E.4.3.7	Multiple open requests for a same type	20
	E.4.3.8	Abnormal situations	20
	E.4.3.9	Uplink error messages.....	21
E.4.4		Advanced data link operations.....	24
E.4.5		State aircraft data link operation.....	24
E.5		Middle East/Asia (MID/ASIA) Region	25
	E.5.1	Administrative provisions related to data link operations	25
	E.5.2	Controller and radio operator procedures	25
	E.5.3	Flight crew procedures	25
	E.5.4	Advanced data link operations.....	25
	E.5.5	State aircraft data link operation.....	25
E.6		North-America (NAM) Region	25
	E.6.1	Administrative provisions related to data link operations	25
	E.6.2	Controller and radio operator procedures	27
	E.6.3	Flight crew procedures	28
	E.6.4	Advanced data link operations.....	28
	E.6.5	State aircraft data link operation.....	28
E.7		North Atlantic (NAT) Region.....	28
	E.7.1	Administrative provisions related to data link operations	28
		E.7.1.1 ANSP service provision.....	28
		E.7.1.2 Uplink message elements unsuited for NAT operations.....	31
		E.7.1.3 Unsupported CPDLC downlink message elements – NAT	31
		E.7.1.4 Reporting requirements in NAT airspace where ADS-C is available.....	32
	E.7.2	Controller and radio operator procedures	33
		E.7.2.1 Voice communication procedures.....	33
	E.7.3	Flight crew procedures	34
		E.7.3.1 Voice communication procedures.....	34
	E.7.4	Advanced data link operations.....	36
	E.7.5	State aircraft data link operation.....	36
E.8		Pacific (PAC) Region	36
	E.8.1	Administrative provisions related to data link operations	36
		E.8.1.1 ANSP service provision.....	36
		E.8.1.2 Exchange of turbulence information in Fukuoka FIR.....	40
	E.8.2	Controller and radio operator procedures	41
	E.8.3	Flight crew procedures	41
	E.8.4	Advanced data link operations.....	41
	E.8.5	State aircraft data link operation.....	42
E.9		South-America (SAM) Region	42

E.9.1	Administrative provisions related to data link operations	42
E.9.2	Controller and radio operator procedures	42
E.9.3	Flight crew procedures	42
E.9.4	Advanced data link operations.....	43
E.9.5	State aircraft data link operation.....	43
Appendix F Operator/aircraft specific information		1
F.1	FANS 1/A and ATN B1 product availability	1
F.2	Verifying aircraft registration	2
F.3	CPDLC connection management	3
F.4	Flight crew display – response and acknowledgement.....	3
F.5	FMS processing of waypoints in position reports	4
F.6	Multiple request messages.....	4
F.7	Waypoint sequencing.....	5
F.8	Open uplinks at time of transfer of communications.....	6
F.9	Variable constraints	6
F.10	ADS-C emergency report interval default.....	6
F.11	Message latency monitor	6
F.12	Terminating ADS-C connections	7
F.13	SATCOM channel format.....	8
F.14	Transfer of ATSU.....	8
F.15	Number of ADS-C connections.....	8
F.16	Lateral deviation events on offsets	8
F.17	Assigned block altitude.....	9
F.18	FANS 1/A-ATN B1 aircraft behavior for automatic CPDLC transfers	9
F.19	CM contact procedure.....	10
F.20	Duplicate CPDLC uplink message processing	10
F.21	Response to end-service and error uplink messages.....	10
F.22	CPDLC connection after logon	11
F.23	ARINC 424 oceanic waypoints	11
F.24	STANDBY response to pilot-initiated downlink request	12

FOREWORD.

1. Historical background

1.1 The *Global Operational Data Link Document* (GOLD) is the result of the progressive evolution of the ICAO Asia-Pacific (APAC) *Initial Future Air Navigation System (FANS 1/A) Operations Manual*, the North Atlantic (NAT) *Guidance Material for ATS Data Link Services in North Atlantic Airspace* and the Eurocontrol *LINK2000+ Guidance Material* for the aeronautical telecommunication network baseline 1 (ATN B1).

1.2 Each of these founding documents provided guidance on a regional basis. However, in recognition of the need to provide globally harmonized guidance on data link operations, the GOLD, First Edition, merging initially the APAC and NAT guidance material, was adopted by the APAC and NAT Regions in 2010. The Second Edition of the GOLD enabled integration of the LINK2000+ guidance material.

1.3 The GOLD addresses data link service provision, operator readiness, controller and flight crew procedures, performance-based specifications and post-implementation monitoring and analysis.

2. Scope and purpose

2.1 The GOLD provides guidance and information concerning data link operations and is intended to facilitate the uniform application of Standards and Recommended Practices contained in Annex 2 — *Rules of the Air*, Annex 10 — *Aeronautical Telecommunications* and Annex 11 — *Air Traffic Services*, the provisions in the *Procedures for Air Navigation Services — Air Traffic Management* (PANS-ATM, Doc 4444) and, when necessary, the *Regional Supplementary Procedures* (Doc 7030).

2.2 This guidance material is intended to improve safety and maximize operational benefits by promoting seamless and interoperable data link operations throughout the world. This edition applies to the FANS 1/A and ATN B1 data link operations using automatic dependent surveillance — contract (ADS-C), controller-pilot data link communications (CPDLC) and the flight management computer waypoint position reporting (FMC WPR). Additional guidance is provided on the use of automatic dependent surveillance – broadcast (ADS-B) in-trail procedures (ITP). It also addresses the performance of the data link applications taking into consideration the transmission media used by those applications.

2.3 The following personnel and organizations should be familiar with relevant aspects of its contents: regulators, airspace planners, aircraft operators, dispatchers, air navigation service providers (ANSPs), aeronautical stations, communication service providers (CSPs), satellite service providers (SSPs) and radio operators, training organizations, regional/State monitoring agencies, automation specialists at centers and radio facilities, and aircraft manufacturers and equipment suppliers.

2.4 The guidance will support the following activities:

- a) The States' roles and responsibilities in relation to the following:
 - 1) Safety regulatory oversight of air navigation services;
 - 2) Operational authorizations, flight crew training and qualification; and
 - 3) Design approval of aircraft data link systems.

- b) The development of agreements and/or contractual arrangements between ANSPs and aircraft operators and their respective communication service providers;
- c) The development of operational procedures; and
- d) Operational monitoring, analysis, and exchange of operational data among regions, States, and communication service providers.

3. Status

This guidance is approved and maintained by the respective participating PIRGs and has a status of an ICAO regional guidance material. It contains material that may eventually become Standards and Recommended Practices (SARPs) or PANS provisions when it has reached the maturity and stability necessary for adoption or approval. It also comprises material prepared as an amplification of the basic principles in the corresponding SARPs, and designed particularly to assist the user in the application of the SARPs and PANS.

4. Implementation

With a view of facilitating implementation of the provisions herein by States, this guidance material has been prepared using language that permits direct use by all users.

5. References

6.1 The following references are cited in this document:

- a) ICAO Annex 1 — *Personnel Licensing*
- b) ICAO Annex 2 — *Rules of the Air*
- c) ICAO Annex 4 — *Aeronautical Charts*
- d) ICAO Annex 6 — *Operation of Aircraft – Part I – International Commercial Air Transport – Aeroplanes*
- e) ICAO Annex 10 — *Aeronautical Telecommunications – Volume II – Communication Procedures including those with PANS status*
- f) ICAO Annex 10 — *Aeronautical Telecommunications – Volume III – Communication Systems*
- g) ICAO Annex 11 — *Air Traffic Services*
- h) ICAO Annex 15 — *Aeronautical Information Services*
- i) *Procedures for Air Navigation Services – Air Traffic Management* (PANS-ATM, ICAO Doc 4444)
- j) *Regional Supplementary Procedures* (Regional SUPPs, ICAO Doc 7030)
- k) *Procedures for Air Navigation Services – ICAO Abbreviations and Codes* (PANS-ABC, ICAO Doc 8400)
- l) *Designators for Aircraft Operating Agencies, Aeronautical Authorities and Services* (ICAO Doc 8585)

- m) *Aircraft Type Designators* (ICAO Doc 8643)
- n) *Manual on Airspace Planning Methodology for the Determination of Separation Minima* (ICAO Doc 9689)
- o) *Performance-based Navigation Manual* (PBN) (ICAO Doc 9613)
- p) *Manual on Required Communication Performance* (RCP) (ICAO Doc 9869)
- q) *Manual on Airborne Surveillance Applications* (Doc 9994)
- r) *In Trail Procedure (ITP) Using Automatic Dependant Surveillance - Broadcast (ADS-B)*" (ICAO Circular 325)
- s) *Safety and Performance Standard for Air Traffic Data Link Services in Oceanic and Remote Airspace* (Oceanic SPR Standard, RTCA DO-306/EUROCAE ED-122)
- t) *Safety and Performance Standard for Air Traffic Data Link Services in Continental Airspace* (Continental SPR Standard, RTCA DO-290/EUROCAE ED-120, Change 1 and Change 2)
- u) *Interoperability Requirements for ATS Applications Using ARINC 622 Data Communications* (FANS 1/A INTEROP Standard, RTCA DO-258A/EUROCAE ED-100A)
- v) *Interoperability Requirements Standard for Aeronautical Telecommunication Network Baseline 1* (ATN B1 INTEROP Standard, RTCA DO-280B/EUROCAE ED-110B)
- w) *Future Air Navigation System 1/A — Aeronautical Telecommunication Network Interoperability Standard* (FANS 1/A — ATN B1 INTEROP Standard, RTCA DO-305A/EUROCAE ED-154A)
- x) *Safety, Performance and Interoperability Requirements Document for In-Trail Procedure in Oceanic Airspace* (RTCA DO-312/EUROCAE ED-159) and Supplement
- y) *Navigation Systems Data Base* (ARINC 424)
- z) *Advanced Flight Management Computer System* (ARINC 702A)

6. Changes to the document

This document is maintained as a regional document in coordination with all ICAO planning and implementation regional groups (PIRGs) providing data link services within their region. Each participating PIRG establishes a mechanism for submitting and administering change proposals.

Change proposals (CPs) can be submitted by any stakeholder participating in data link operations. The stakeholder should submit a Change Proposal to their ICAO regional office (see [Appendix E](#)). The ICAO regional office will coordinate the change proposal within its own region, other regions, and ICAO HQ, to determine the acceptability of the change proposal. Once the ICAO regional office has completed coordination and the participating PIRGs accept the change proposal, the change is concluded by each of the PIRGs.

Amendments to the GOLD

Amendment	Source(s)	Subject(s)	Approved Applicable
1 st Edition (2010)	Asia/Pacific Air Navigation Planning and Implementation Regional Group (APANPIRG/20 – 2009) North Atlantic Systems Planning Group (NAT SPG/46 – 2010)	<i>Global Operational Data Link Document (GOLD)</i>	Applicable within participating Regions on 1 July 2010.
2 nd Edition (2013)	European Air Navigation Planning (EANPG/52 – 2010) South American (SAM) Implementation Group (SAM/IG/8 – 2011) African Indian Ocean Planning and Implementation Regional Group (APIRG/18 – 2012)	This Edition will allow GOLD to be applicable to data link implementations based on existing data link capabilities (i.e. FANS 1/A, ATN B1 and FANS 1/A-ATN B1 aircraft and ground systems) in airspace where procedural separations are applied and where ATS surveillance services are provided. This Edition includes: a) general data link descriptions and common procedures; b) changes to address High Level Safety Conference (HLSC) recommendations; c) CPDLC procedures and messages for ATC-initiated re-route procedure and ADS-B in trail procedure (ITP); d) guidance related to the position reporting requirements in ADS-C environments (e.g. reporting revised time estimates); e) additional guidance on RCP – RSP and post-implementation monitoring; and f) A modified section to facilitate Region / State specific guidance and new material specific to European Region.	Applicable within participating Regions on 1 December 2013.

Chapter 1. Definitions

1.1 Terms and definitions

When the following terms are used in this document they have the following meanings. Where the term has “(ICAO)” annotated, the term has already been defined as such in SARPs and/or PANS.

Term

ADS-C service. A term used to indicate an ATS service that provides surveillance information by means of the ADS-C application.

Note.— ICAO Doc 4444 does not include ADS-C in its definition for ATS surveillance system. Therefore, an ATS surveillance service does not consider those provided by means of the ADS-C application, unless it can be shown by comparative assessment to have a level of safety and performance equal to or better than monopulse SSR.

Aeronautical fixed telecommunication network (AFTN). A worldwide system of aeronautical fixed circuits provided, as part of the aeronautical fixed service, for the exchange of messages and/or digital data between aeronautical fixed stations having the same or compatible communications characteristics. (ICAO)

Aeronautical Information Publication (AIP). A publication issued by or with the authority of a State and containing aeronautical information of a lasting character essential to air navigation. (ICAO)

Aeronautical operational control (AOC). Communication required for the exercise of authority over the initiation, continuation, diversion or termination of flight for safety, regularity and efficiency reasons. (ICAO)

Aeronautical telecommunication network (ATN). A global internetwork architecture that allows ground, air-ground and avionic data subnetworks to exchange digital data for the safety of air navigation and for the regular, efficient and economic operation of air traffic services. (ICAO)

Air navigation services provider (ANSP). An organization responsible for the provision of air traffic services.

Air traffic control (ATC) clearance. Authorization for an aircraft to proceed under conditions specified by an air traffic control unit.

Note 1.— For convenience, the term “air traffic control clearance” is frequently abbreviated to “clearance” when used in appropriate contexts.

Note 2.— The abbreviated term “clearance” may be prefixed by the words “taxi”, “take-off”, “departure”, “en-route”, “approach” or “landing” to indicate the particular portion of flight to which the air traffic control clearance relates.

(ICAO)

Term

Air traffic control (ATC) service. A service provided for the purpose of:

- a) Preventing collisions:
 - 1) Between aircraft, and
 - 2) On the manoeuvring area between aircraft and obstructions; and
- b) Expediting and maintaining an orderly flow of air traffic. (ICAO)

Air traffic management (ATM). The dynamic, integrated management of air traffic and airspace including air traffic services, airspace management and air traffic flow management — safely, economically and efficiently — through the provision of facilities and seamless services in collaboration with all parties and involving airborne and ground-based functions. (ICAO)

Air traffic service (ATS). A generic term meaning variously, flight information service, alerting service, air traffic advisory service, air traffic control service (area control service, approach control service or aerodrome control service). (ICAO)

Air traffic services unit (ATSU). A generic term meaning variously, air traffic control unit, flight information centre or air traffic services reporting office. (ICAO)

Airborne collision avoidance system (ACAS). An aircraft system based on secondary surveillance radar (SSR) transponder signals which operates independently of ground-based equipment to provide advice to the pilot on potential conflicting aircraft that are equipped with SSR transponders. (ICAO)

Aircraft active flight plan. (See flight plan).

Aircraft address. A unique combination of 24 bits available for assignment to an aircraft for the purpose of air-ground communications, navigation and surveillance. (ICAO)

Aircraft identification. A group of letters, figures or a combination thereof which is either identical to, or the coded equivalent of, the aircraft call sign to be used in air-ground communications, and which is used to identify the aircraft in ground-ground air traffic services communications. (ICAO)

Note 1.— The aircraft identification does not exceed 7 characters and is either the aircraft registration or the ICAO designator for the aircraft operating agency followed by the flight identification.

Note 2.— ICAO designators for aircraft operating agencies are contained in ICAO Doc 8585.

Aircraft registration. A group of letters, figures or a combination thereof which is assigned by the State of Registry to identify the aircraft.

Note.— Also referred to as registration marking.

Term

Aircraft system availability (A_{AIRCRAFT}). The required probability of available capability on an aircraft with an average flight of 6 hours.

Note.— *The actual aircraft system availability is computed assuming that the service is available in the relevant airspace.*

Air-report. A report from an aircraft in flight prepared in conformity with requirements for position, and operational and/or meteorological reporting. (ICAO)

Altitude reservation (ALTRV). Airspace utilization under prescribed conditions normally employed for the mass movement of aircraft or other special requirements which cannot otherwise be accomplished.

Appropriate ATS authority. The relevant authority designated by the State responsible for providing air traffic services in the airspace concerned. (ICAO)

Appropriate authority.

- a) Regarding flight over the high seas: The relevant authority of the State of Registry.
- b) Regarding flight other than over the high seas: The relevant authority of the State having sovereignty over the territory being overflown. (ICAO)

Area control centre (ACC). A unit established to provide air traffic control service to controlled flights in control areas under its jurisdiction. (ICAO)

Area navigation (RNAV) specification. See navigation specification. (ICAO)

ATC waypoint. A waypoint contained in Item 15 of the ICAO flight plan, or as amended by ATC.

Note.— *A waypoint inserted by the flight crew for purposes of conducting flight operations such as points of no return are not ATC waypoints.*

ATS interfacility data communication (AIDC). Automated data exchange between air traffic services units, particularly in regard to co-ordination and transfer of flights. (ICAO)

ATS surveillance service. A term used to indicate a service provided directly by means of an ATS surveillance system. (ICAO)

ATS surveillance system. A generic term meaning variously, ADS-B, PSR, SSR or any comparable ground-based system that enables the identification of aircraft.

Note.— *A comparable ground-based system is one that has been demonstrated, by comparative assessment or other methodology, to have a level of safety and performance equal to or better than monopulse SSR.*

(ICAO)

Term

Automatic dependent surveillance — broadcast (ADS-B). A means by which aircraft, aerodrome vehicles and other objects can automatically transmit and/or receive data such as identification, position and additional data, as appropriate, in a broadcast mode via a data link. (ICAO)

Automatic dependent surveillance — contract (ADS-C). A means by which the terms of an ADS-C agreement will be exchanged between the ground system and the aircraft, via a data link, specifying under what conditions ADS-C reports would be initiated, and what data would be contained in the reports. (ICAO)

Note.— The abbreviated term “ADS contract” is commonly used to refer to ADS event contract, ADS demand contract, ADS periodic contract or an emergency mode.

C for RCTP. The proportion of intervention messages and responses that can be delivered within the specified RCTP time for intervention.

C for RCTP_{AIR}. The proportion of intervention messages and responses that can be delivered within the specified RCTP_{AIR} time for intervention.

C for RCTP_{ATSU}. The proportion of intervention messages and responses that can be delivered within the specified RCTP_{ATSU} time for intervention.

C for RCTP_{CSP}. The proportion of intervention messages and responses that can be delivered within the specified RCTP_{CSP} time for intervention.

C for RSTP_{AIR}. The proportion of surveillance messages that can be delivered within the specified RSTP_{AIR} time.

C for RSTP_{ATSU}. The proportion of surveillance messages that can be delivered within the specified RSTP_{ATSU} time.

C for RSTP_{CSP}. The proportion of surveillance messages that can be delivered within the specified RSTP_{CSP} time.

C for TRN. The proportion of intervention messages and responses that can be delivered within the specified TRN time for intervention.

Call sign. The designator used in air-ground communications to identify the aircraft and is equivalent to the encoded aircraft identification.

Closed message. A message that:

- a) Contains no message elements that require a response; or
- b) Has received a closure response.

Term

Closure response. A message containing a message element that has the ability to close another message.

Compulsory reporting point. An ATC waypoint for which a position report is required by the aircraft.

Control area (CTA). A controlled airspace extending upwards from a specified limit above the earth. (ICAO)

Controller. A person authorized by the appropriate authority to provide air traffic control services.

Controller-pilot data link communications (CPDLC). A means of communication between controller and pilot, using data link for ATC communications. (ICAO)

CPDLC dialogue. (See ICAO definition for “dialogue.”)

- a) A single message that is a closed message; or
- b) A series of messages beginning with an open message, consisting of any messages related to the original open message and each other through the use of a Message Reference Number (MRN) and ending when all of these messages are closed.

CPDLC message. Information exchanged between an airborne application and its ground counterpart. A CPDLC message consists of a single message element or a combination of message elements conveyed in a single transmission by the initiator.

Note.— The abbreviated term ‘message’ is commonly used to refer to a CPDLC message.

CPDLC message element. A component of a message. A message element is defined for specific uses (e.g. vertical clearance, route modification). A “free text message element” provides additional capability.

Note.— The abbreviated term ‘message element’ is commonly used to refer to a CPDLC message element.

Current data authority (CDA). The designated ground system through which a CPDLC dialogue between a pilot and a controller currently responsible for the flight is permitted to take place. (ICAO)

Current flight plan. (See flight plan).

Data link initiation capability (DLIC). A data link application that provides the ability to exchange addresses, names and version numbers necessary to initiate data link applications. (ICAO)

Dialogue. A co-operative relationship between elements which enables communication and joint operation. (ICAO)

Downlink message (DM). A CPDLC message sent from an aircraft.

Term

Dynamic airborne re-route procedure (DARP). The procedure for executing a re-route clearance initiated by a request from AOC.

Filed flight plan. (See flight plan).

Flight crew member. A person authorized by the appropriate authority charged with duties essential to the operations of an aircraft on the flight deck during a flight duty period.

Flight identification. A group of numbers, which is usually associated with an ICAO designator for an aircraft operating agency, to identify the aircraft in Item 7 of the flight plan.

Flight information region (FIR). An airspace of defined dimensions within which flight information service and alerting service are provided. (ICAO)

Flight level (FL). A surface of constant atmospheric pressure which is related to a specific pressure datum, 1 013.2 hectopascals (hPa), and is separated from other such surfaces by specific pressure intervals. (ICAO)

Note 1.— A pressure type altimeter calibrated in accordance with the Standard Atmosphere:

a) when set to a QNH altimeter setting, will indicate altitude;

b) when set to QFE altimeter setting, will indicate height above the QFE reference datum;

c) when set to a pressure of 1 013.2 hPa, may be used to indicate flight levels.

Note 2.— The terms “height” and “altitude”, used in Note 1 above, indicate altimetric rather than geometric heights and altitudes.

Flight plan. Specified information provided to air traffic services units, relative to an intended flight or portion of a flight of an aircraft. (ICAO)

A flight plan can take several forms, such as:

Current flight plan (CPL). The flight plan, including changes, if any, brought about by subsequent clearances. (ICAO)

Note 1.— When the word “message” is used as a suffix to this term, it denotes the content and format of the current flight plan data sent from one unit to another.

Filed flight plan (FPL). The flight plan as filed with an ATS unit by the pilot or a designated representative, without any subsequent changes. (ICAO)

Note 2.— When the word “message” is used as a suffix to this term, it denotes the content and format of the filed flight plan data as transmitted.

Aircraft active flight plan. The flight plan used by the flight crew. The sequence of legs and associated constraints that define the expected 3D or 4D trajectory of the aircraft from takeoff to landing. (RTCA/EUROCAE)

Term

FMC WPR service. A term used to indicate an ATS service that provides surveillance information by means of the FMC WPR application.

Note.— ICAO Doc 4444 does not include FMC WPR in its definition for ATS surveillance system. Therefore, an ATS surveillance service does not consider those provided by means of the FMC WPR application, unless it can be shown by comparative assessment to have a level of safety and performance equal to or better than monopulse SSR.

Figure of merit. An indication of the aircraft navigation system's ability to maintain position accuracy.

Free text message element. A message element used to exchange information not conforming to a defined message element.

Lateral deviation event (LDE). A type of event that triggers an ADS-C report when the absolute value of the lateral distance between the aircraft's actual position and the aircraft's expected position on the aircraft active flight plan becomes greater than the lateral deviation threshold.

Level range deviation event (LRDE). A type of event that triggers an ADS-C report when the aircraft's level is higher than the level ceiling or the aircraft's level is lower than the level floor.

Note.— Sometimes referred to as altitude range change event or altitude range event.

Maximum accumulated unplanned outage time (min/yr). Measured by accumulating *only* the duration times for unplanned outages greater than the unplanned outage duration limit during any 12-month period. The accumulation is performed separately for each relevant operational airspace.

Maximum number of unplanned outages. Measured separately for each relevant operational airspace over any 12-month period.

Message. Basic unit of user information exchanged between an airborne application and its ground counterpart or between two ground applications. Messages are passed in one or more data blocks from one end user to another through different subnetworks. (ICAO Doc 9880)

Note.— Used in this document to mean CPDLC message.

Message element. A component of a message used to define the context of the information exchanged. (ICAO Doc 9880)

Note.— Used in this document to mean CPDLC message element.

Message element identifier. The ASN.1 tag of the ATCUplinkMsgElementId or the ATCDnlinkMsgElementId. (ICAO)

Message identification number (MIN). An integer in the range 0 to 63 (inclusive) that uniquely identifies specific uplink and downlink messages for each CPDLC connection.

Military assumes responsibility for the separation of aircraft (MARSAs). Procedures between the controller and the aircraft that delegate the separation responsibility temporarily to the military authority operating the flights, thereby relieving ATC of the separation workload.

Term

Minimum equipment list (MEL). A list which provides for the operation of aircraft, subject to specified conditions, with particular equipment inoperative, prepared by an operator in conformity with, or more restrictive than, the MMEL established for the aircraft type. (ICAO)

Monitored operational performance (TRN). The portion of the transaction time (used for intervention) that does not include the times for message composition or recognition of the operational response.

Multi-element message. A CPDLC message consisting of more than one message element (clearance, instruction or information), handled by the controller of the flight crew as a single message.

Navigation specification. A set of aircraft and flight crew requirements needed to support performance-based navigation operations within a defined airspace. There are two kinds of navigation specifications:

Required navigation performance (RNP) specification. A navigation specification based on area navigation that includes the requirement for performance monitoring and alerting, designated by the prefix RNP (e.g. RNP 4, RNP APCH).

Area navigation (RNAV) specification. A navigation specification based on area navigation that does not include the requirement for performance monitoring and alerting, designated by the prefix RNAV (e.g. RNAV 5, RNAV 1).

Note 1.— The Performance-based Navigation (PBN) Manual (Doc 9613), Volume II, contains detailed guidance on navigation specifications.

Note 2.— The term RNP, previously defined as “a statement of the navigation performance necessary for operation within a defined airspace”, has been removed from this Annex as the concept of RNP has been overtaken by the concept of PBN. The term RNP is now solely used in the context of navigation specifications that require performance monitoring and alerting (e.g. RNP 4 refers to the aircraft and operating requirements, including a 4 NM lateral performance with on-board performance monitoring and alerting that are detailed in Doc 9613).

Next data authority. The ground system so designated by the current data authority through which an onward transfer of communications and control can take place. (ICAO)

NOTAM. A notice distributed by means of telecommunication containing information concerning the establishment, condition or change in any aeronautical facility, service, procedure or hazard, the timely knowledge of which is essential to personnel concerned with flight operations. (ICAO)

Open message. A message that contains at least one message element that requires a response. An open message remains open until the required response is received.

Operational communication transaction. The process a human uses to initiate the transmission of an instruction, clearance, flight information, and/or request, and is completed when that human is confident that the transaction is complete.

Term

Performance-based communication (PBC). ATS communication services and capability based on performance requirements for air traffic service provision, aircraft and flight operations along an ATS route, on an instrument approach procedure or in a designated airspace.

Note.— Communication performance requirements are allocated to system components in an RCP specification in terms of communication transaction time, continuity, availability, integrity, safety and functionality needed for the proposed operation in the context of a particular airspace concept.

Performance-based navigation (PBN). Area navigation based on performance requirements for aircraft operating along an ATS route, on an instrument approach procedure or in a designated airspace.

Note.— Performance requirements are expressed in navigation specifications (RNAV specification, RNP specification) in terms of accuracy, integrity, continuity, availability and functionality needed for the proposed operation in the context of a particular airspace concept. (ICAO)

Performance-based surveillance (PBS). ATS surveillance services and capability based on performance requirements for air traffic service provision, aircraft and flight operations along an ATS route, on an instrument approach procedure or in a designated airspace.

Note.— Surveillance performance requirements are allocated to system components in an RSP specification in terms of surveillance data delivery time, continuity, availability, integrity, accuracy of the surveillance data, safety and functionality needed for the proposed operation in the context of a particular airspace concept.

Preformatted free text message. A free text message element that is stored within the aircraft system or ground system for selection.

Procedural control. Term used to indicate that information derived from an ATS surveillance system is not required for the provision of air traffic control service. (ICAO)

Procedural separation. The separation used when providing procedural control. (ICAO)

Radio operator. A person authorized by the appropriate authority to relay a radiotelephony communication between the ATSU and the flight crew.

RCP availability (A). The required probability that an operational communication transaction can be initiated when needed.

RCP continuity (C). The required probability that an operational communication transaction can be completed within the communication transaction time, either ET or TT 95%, given that the service was available at the start of the transaction.

RCP expiration time (ET). The maximum time for the completion of the operational communication transaction after which the initiator is required to revert to an alternative procedure.

Term

RCP integrity (I). The required probability that an operational communication transaction is completed with no undetected errors.

Note.— Whilst RCP integrity is defined in terms of the “goodness” of the communication capability, it is specified in terms of the likelihood of occurrence of malfunction on a per flight hour basis (e.g. 10^{-5}), consistent with RNAV/RNP specifications.

RCP nominal time (TT 95%). The maximum nominal time within which 95% of operational communication transactions is required to be completed.

RCP type. A label (e.g. RCP 240) that represents the values assigned to RCP parameters for communication transaction time, continuity, availability and integrity. (ICAO)

Note.— This document uses the term RCP specification to align RCP with RNP and RNAV specifications provided in the Performance Based Navigation Manual.

RCTP_{AIR}. The summed critical transit times for an ATC intervention message and a response message, allocated to the aircraft system.

RCTP_{ATSU}. The summed critical transit times for an ATC intervention message and a response message, allocated to the ATSU system.

RCTP_{CSP}. The summed critical transit times for an ATC intervention message and a response message, allocated to the CSP system.

Required communication performance (RCP) specification. A set of requirements for air traffic service provision, aircraft capability, and operations needed to support performance-based communication within a defined airspace.

Note 1.— See ICAO Doc 9869 and [Appendix B](#) of this document for RCP specifications.

Note 2.— The term RCP, currently defined by ICAO as “a statement of performance requirements for operational communication in support of specific ATM functions”, is used in this document to align the concept of PBC with the concept of PBN. The term RCP is now used in the context of a specification that is applicable to the prescription of airspace requirements, qualification of ATS provision, aircraft capability, and operational use, including post-implementation monitoring (e.g. RCP 240 refers to the criteria for various components of the operational system to ensure an acceptable intervention capability for the controller is maintained).

Required communication technical performance (RCTP). The portion of the (intervention) transaction time that does not include the human times for message composition, operational response, and recognition of the operational response.

Required surveillance technical performance (RSTP). The technical transit time for surveillance data delivery from the time associated with the aircraft’s position to when the recipient (e.g. ATSU) receives the report, but does not include the generation or processing of the report.

Required navigation performance (RNP) specification. See navigation specification. (ICAO)

Term

Required surveillance performance (RSP) specification. A set of requirements for air traffic service provision, aircraft capability, and operations needed to support performance-based surveillance within a defined airspace.

Note 1.— See ICAO Doc 9869 and [Appendix C](#) of this document for RSP specifications.

Note 2.— The term RSP is used in the context of a specification that is applicable to the prescription of airspace requirements, qualification of ATS provision, aircraft capability, and operational use, including post-implementation monitoring (e.g. RSP 180 refers to the criteria for various components of the operational system to ensure an acceptable surveillance capability for the controller is maintained).

Responder performance criteria. The operational portion of the transaction time to prepare the operational response, and includes the recognition of the instruction, and message composition (e.g. flight crew/HMI) for intervention transactions.

RSTP_{AIR}. The overdue (OD) and nominal (DT) transit times for surveillance data from the aircraft system to the antenna.

RSTP_{ATSU}. The overdue (OD) and nominal (DT) transit times for surveillance data from the CSP interface to the ATSU's flight data processing system.

RSTP_{CSP}. The overdue (OD) and nominal (DT) transit times for surveillance data allocated to the CSP.

Service availability (A_{CSP}). The required probability that the communication service is available to all users in a specific airspace when desired.

Standardized free text message. A message element that uses a defined free text message format, using specific words in a specific order which has been agreed by stakeholders. Standardized free text message elements may be manually entered by the user or may be a preformatted free text message.

Standard message element. Any message element defined by ICAO Doc 4444 that does not contain the [free text] parameter.

RSP availability (A). The required probability that surveillance data can be provided when needed.

RSP continuity (C). The required probability that surveillance data can be delivered within the surveillance delivery time parameter, either OT or DT 95%, given that the service was available at the start of delivery.

Surveillance data. Data pertaining to the identification of aircraft and/or obstructions for route conformance monitoring and safe and efficient conduct of flight.

Surveillance data delivery. The process for obtaining surveillance data.

RSP data transit time. The required time for surveillance data delivery.

Term

RSP integrity (I). The required probability that the surveillance data is delivered with no undetected error.

Note 1.— Surveillance integrity includes such factors as the accuracy of time, correlating the time at aircraft position, reporting interval, data latency, extrapolation and/or estimation of the data.

Note 2.— Whilst surveillance integrity is defined in terms of the “goodness” of the surveillance capability, it is specified in terms of the likelihood of occurrence of malfunction on a per flight hour basis (e.g. 10^{-5}), consistent with RCP and RNAV/RNP specifications.

RSP nominal delivery time (DT 95%). The maximum nominal time within which 95% of surveillance data is required to be delivered.

RSP overdue delivery time (OT). The maximum time for the successful delivery of surveillance data after which the initiator is required to revert to an alternative procedure.

RSP specification. A set of ATS provision, including communication services, aircraft and operator requirements (e.g. RSP 180) needed for surveillance supporting a performance-based operation within a defined airspace.

Required surveillance performance (RSP). A statement of the performance requirements for operational surveillance in support of specific ATM functions.

Tailored arrival (TA). A 4-dimensional (4-D) arrival procedure, based on an optimized ATC clearance, including, as necessary, vertical and/or speed restrictions, from the aircraft's current position, normally just prior to top of descent, to the designated destination runway. The TA clearance is issued via CPDLC data link message(s) to the aircraft and automatically loaded into the aircraft's 4-D trajectory guidance capability.

Time critical situation. A situation when a prompt controlling action is required in the provision of air traffic services.

Note.— Time-criticality is mainly determined by the following factors: ATC traffic situation, end-to-end performance (systems and flight crew/controller response time), recovery time and controller/flight crew confidence and experience on the means of communication that are available.

Unplanned outage duration limit (minutes). Time after the unplanned outage begins at which there is an operational impact. Measured from when an unplanned outage begins to when the ATSU receives notification that the service has been restored.

Unplanned outage notification delay (min). Notification to the ATSU of an unplanned outage. Measured from when the unplanned outage begins to when the ATSU receives notification.

Uplink message (UM). A CPDLC message sent from a ground system.

Vertical rate change event (VRE). A type of event that triggers an ADS-C report when the aircraft's rate of climb or descent is greater than the vertical rate threshold.

Term

Waypoint change event (WCE). A type of event that triggers an ADS-C report when there is a change in the next waypoint or the next plus 1 waypoint on the aircraft active flight plan.

1.2 Acronyms

When the following acronyms are used in this document they have the following meanings. Where the term has “(ICAO)” annotated, the acronym has already been defined as such in SARPs and/or PANS.

Acronym	Description
AAR	Air-to-air refueling.
ACARS	Aircraft communications addressing and reporting system.
ACAS	Aircraft collision avoidance system. (ICAO)
ACC	Area control centre. (ICAO)
ACL	ATS clearance (data link service).
ACM	ATS communications management (data link service).
ACP	Actual communication performance.
ACTP	Actual communication technical performance.
ADS	Automatic dependent surveillance (retained for reference with non-updated documents. This term would normally be used to refer to ADS-C).
ADS-B	Automatic dependent surveillance – broadcast. (ICAO)
ADS-C	Automatic dependent surveillance – contract. (ICAO)
AFN	ATS facilities notification.
AFTN	aeronautical fixed telecommunication network. (ICAO)
AGL	Above ground level (ICAO)
AIC	Aeronautical information circular. (ICAO)
AIDC	ATS interfacility data communications. (ICAO)
AIP	Aeronautical Information Publication. (ICAO)

Acronym	Description
AIREP	Air-report. (ICAO)
ALTRV	Altitude reservation.
AMC	ATS microphone check (data link service).
AMS(R)S	Aeronautical mobile satellite (route) service. (ICAO)
ANSP	Air navigation service provider.
AOC	Aeronautical operational control. (ICAO)
ARCP	Air refueling control point. (ICAO abbreviation?)
AREX	Air refueling exit point. (ICAO abbreviation?)
ARIP	Air refueling initial point. (ICAO abbreviation?)
ARP	Air-report message. (See AIREP)
ATC	Air traffic control. (ICAO)
ATM	Air traffic management. (ICAO)
ATN	Aeronautical telecommunication network. (ICAO)
ATN B1	Aeronautical telecommunication network baseline 1, as defined by RTCA DO-280B/EUROCAE ED-110B. <i>Note.— ATN B1 generally means that the data link system on an aircraft, the ATSU ground system, and communication service provision comply with the standard as adapted by Eurocontrol Specification on Data Link Services (EUROCONTROL-SPEC-0116). ATN B1 consists of the following data link applications:</i> <ul style="list-style-type: none"> <i>a) Context management (CM) for data link initiation capability (DLIC); and</i> <i>b) Limited CPDLC for ATS communications management (ACM), ATS clearance (ACL), and ATC microphone check (AMC).</i>
ATS	Air traffic service. (ICAO)
ATSU	ATS unit. (ICAO, sort of)
CADS	Centralized ADS-C system.
CDA	Current data authority. (See ICAO definition for current data authority)
CFRS	Centralized FMC waypoint reporting system.

Acronym	Description
CM	Context management (data link application).
CNS	Communications, navigation and surveillance. (ICAO)
CNS/ATM	Communications, navigation and surveillance/air traffic management. (ICAO)
CPDLC	Controller-pilot data link communications. (ICAO)
CRC	Cyclic redundancy check.
CSP	Communication service provider.
CTA	Control area. (ICAO)
DARP	Dynamic airborne re-route procedure.
D-ATIS	Data link – automatic terminal information service (data link service).
DCL	Departure clearance (data link service).
DCPC	Direct controller-pilot communications.
DLIC	Data link initiation capability. (ICAO)
DM	Downlink message.
DSC	Downstream clearance (data link service).
EMERG	Emergency. (ICAO)
ETD	Estimated time of departure or estimating departure. (ICAO)
FANS	Future air navigation system.
FANS 1/A	Future air navigation system - initial, as defined by RTCA DO-258A/EUROCAE ED-100A, or previous standards that defined the FANS 1/A capability. <i>Note.— FANS 1/A generally means that the data link system on an aircraft, the ATSU ground system, and communication service provision comply with the standard. In certain cases, specific reference is made to a particular type of FANS 1/A aircraft as follows:</i> <i>a). FANS 1/A+ means that the aircraft completely complies with Revision A of the standard, which includes message latency monitor; and</i> <i>b) FANS 1/A ADS-C means that the aircraft complies with AFN and ADS-C applications, but does not include the CPDLC application.</i>
FDPS	Flight data processing system. (ICAO)

Acronym	Description
FIR	Flight information region. (ICAO)
FL	Flight level.
FLIPCY	Flight plan consistency (data link service).
FMC	Flight management computer.
FMC WPR	Flight management computer waypoint position reporting.
FMS	Flight management system.
GPS	Global positioning system (USA).
HF	High frequency (3-30 Mhz). (ICAO)
IATA	International Air Transport Association.
ICAO	International Civil Aviation Organization. (ICAO)
ICD	Interface control document.
ITP	In trail procedure
LDE	Lateral deviation event.
LRDE	Level range deviation event.
MARSA	Military assumes responsibility for separation of aircraft.
MAS	Message assurance.
MASPS	Minimum aviation system performance standards.
MEL	Minimum equipment list. (ICAO)
MET	Meteorological or meteorology. (ICAO)
MIN	Message identification number.
MRN	Message reference number.
MTBF	Mean time between failures.
MTTR	Mean time to repair.
NDA	Next data authority. (See ICAO definition for next data authority.)

Acronym	Description
ORT	Operational requirements table.
PANS-ATM	Procedures for Air Navigation Services — Air Traffic Management (ICAO Doc 4444). (ICAO)
PBC	Performance-based communication
PBCS	Performance-based communication and surveillance
PBN	Performance-based navigation
PBS	Performance-based surveillance
PORT	Pilot operational response time.
POS	Position report message.
RCP	Required communication performance.
RCTP	Required communication technical performance.
RGS	Radio ground station.
RNAV	Area navigation.
RNP	Required navigation performance.
RSP	Required surveillance performance
RSTP	Required surveillance technical performance.
SARPs	Standards and Recommended Practices. (ICAO)
SATCOM	Satellite communication. (ICAO)
SELCAL	Selective calling system. (ICAO)
TA	Tailored arrival.
TRN	Monitored operational performance.
UM	Uplink message.
UPR	User preferred route.
VDL M0/A	VHF data link mode 0/A subnetwork.

Acronym	Description
VDL M2	VHF data link mode 2 subnetwork,
VHF	Very high frequency (30-300 Mhz). (ICAO)
VRE	Vertical rate change event.
WCE	Waypoint change event.

Chapter 2. Overview of data link operations

2.1 Data link operational capabilities

2.1.1 Data link benefits

2.1.1.1 Data link services provide communications that are intended to support more efficient air traffic management and increase airspace capacity.

2.1.1.2 In addition, in airspace where procedural separation is being applied, the data link services improve communications, surveillance and route conformance monitoring to support operational capabilities that enable:

a) Reduced separations, for example, in addition to navigation performance requirements, the following reduced separations require FANS 1/A aircraft, FANS 1/A ATSU, RCP 240 and RSP 180;

- 1) 50 NM longitudinal separation;
- 2) 30 NM longitudinal separation;
- 3) 30 NM lateral separation;

b) User preferred route (UPR);

c) Dynamic airborne re-route procedure (DARP); and

d) Weather deviation management.

2.1.1.3 CPDLC improves communication capabilities by reducing voice channel congestion and enabling the use of CPDLC-related automation.

2.1.1.4 Depending on the specific implementation, other advantages associated with CPDLC include:

a) Providing direct controller-pilot communications (DCPC) in airspace where it was not previously available;

b) Allowing the flight crew to print messages;

c) Allowing messages to be stored and reviewed as needed;

d) Reducing flight crew-input errors by allowing the loading of information from specific uplink messages, such as route clearances or frequency change instructions, into other aircraft systems, such as the FMS or radios;

e) Allowing the flight crew to request complex route clearances, which the controller can respond to without having to manually enter a long string of coordinates;

f) Reducing flight crew workload by supporting automatically transmitted reports when a specific event occurs, such as crossing a waypoint and the loading of clearance information directly into the flight management system;

g) Reducing controller workload by providing automatic flight plan updates when specific downlink messages (and responses to some uplink messages) are received.

2.1.2 Data link systems – interoperability standards

2.1.2.1 “Data link” is a generic term that encompasses different types of data link systems and subnetworks. [Figure 2-1](#) provides an overview of a data link system, including subnetworks. While all data link capable aircraft have access to VHF data link, not all aircraft have access to additional satellite, and/or HF data link capability. Similarly, not all CSPs have HF data link capability. Some ANSPs do not operationally require, nor allow use of, some of the subnetworks (e.g. SATCOM).

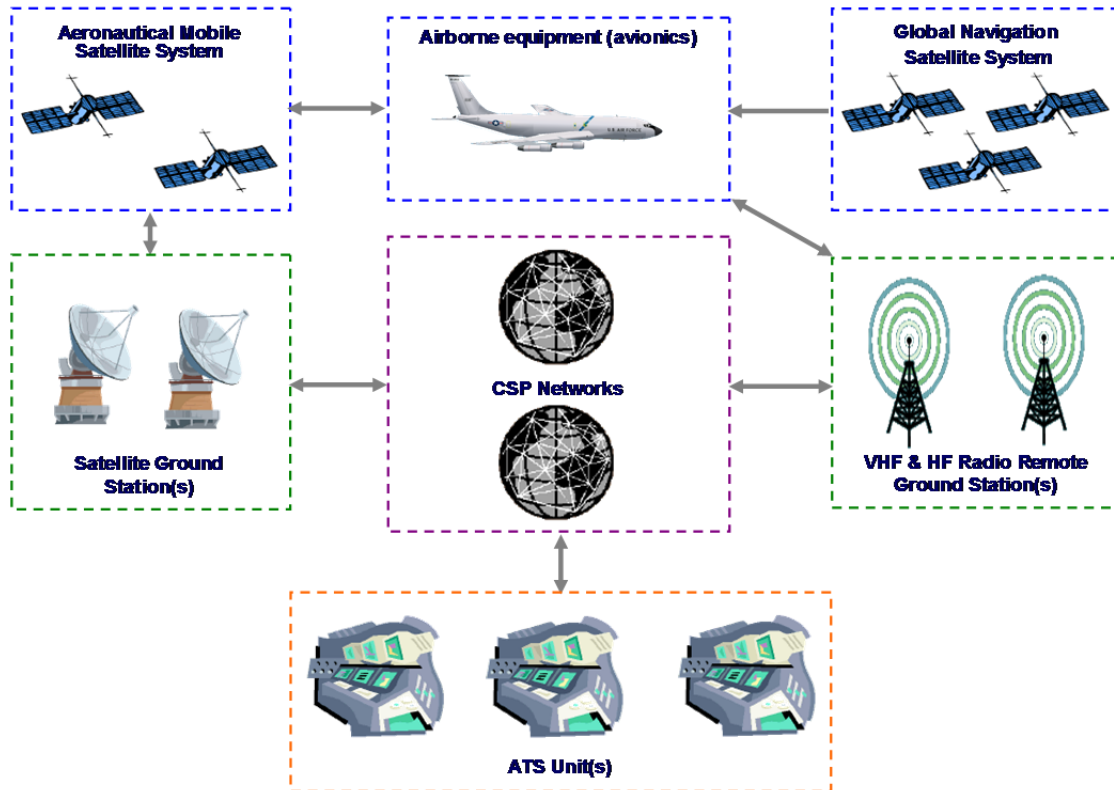

Figure 2-1. Overview of a data link system

2.1.2.2 [Figure 2-2](#) shows different ATSU ground systems and aircraft systems that are interoperable. A designator is assigned to each type of ATSU and aircraft data link system. [Table 2-1](#) provides a brief description for each designator and identifies the applicable interoperability standards.

Note 1.— *RTCA DO-305A/EUROCAE ED-154A chapter 4 provides additional requirements to support automatic CPDLC transfers between ATSUs using different technologies (i.e. FANS 1/A and ATN B1). Refer to [paragraph 3.1.2.2](#) for applicability of chapter 4 in RTCA DO-305A/EUROCAE ED-154A to ATN B1, FANS 1/A-ATN B1 and FANS 1/A ground systems.*

Note 2.— *A single aircraft or a single ATSU may employ multiple types of data link systems. FANS 1/A-ATN B1 aircraft are not specifically depicted in [Figure 2-2](#).*

2.1.2.3 [Table 2-2](#) provides a brief description of each type of subnetwork that supports the different data link systems and identifies the applicable interoperability standards. A designator is assigned to each type of subnetwork shown in [Figure 2-1](#).

2.1.2.4 The applicable interoperability standards for each type of data link system and each type of subnetwork allocate requirements to the operator, the aircraft data link system, and the ANSP to ensure that the aircraft system, the ATSU ground system, and subnetworks are compatible.

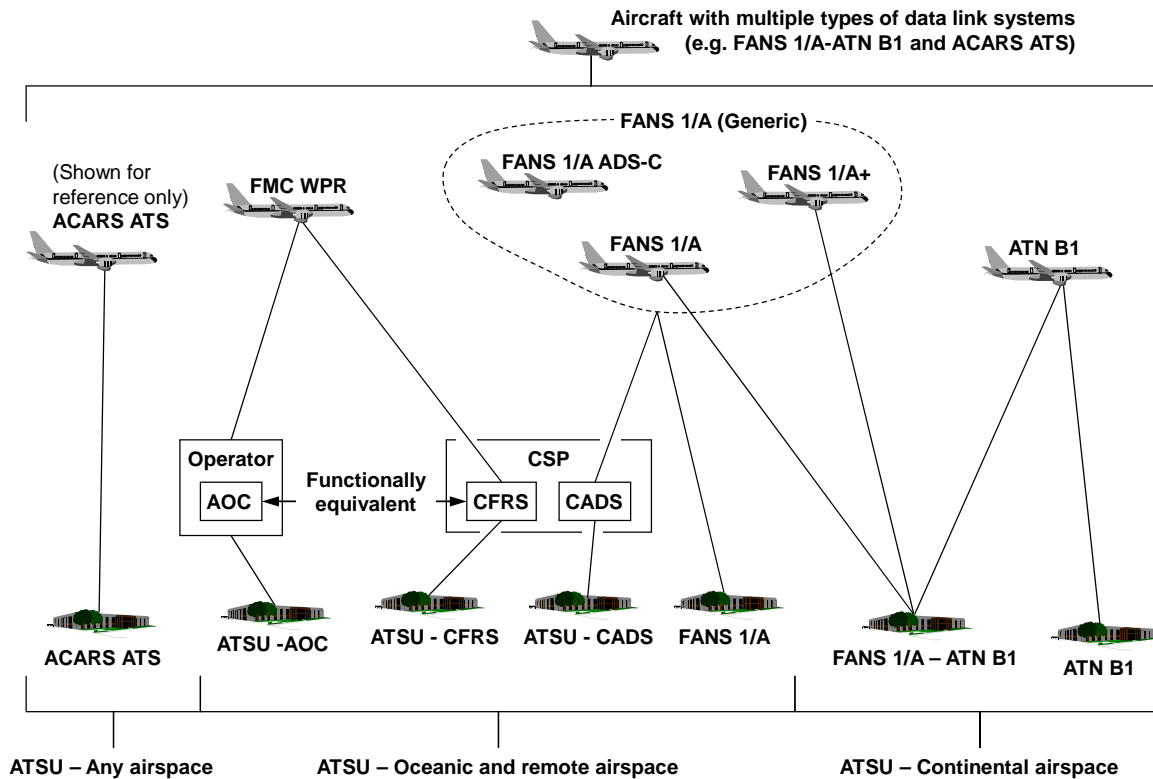

Figure 2-2. Different ATSU/aircraft interoperable connectivity

Table 2-1. Designators for aircraft and ATSU (ground) data link systems

Designator	Description of designator	Applicable interoperability standard(s)	Applicable system
ACARS ATS	ATS applications, departure clearance (DCL), oceanic clearance (OCL) and data link – automatic terminal information service (D-ATIS), supported by aircraft communications addressing and reporting system (ACARS). <i>Note.— ACARS ATS is defined for reference only. Guidance for these applications is not provided in this document.</i>	a) ED-85A (DCL) b) ED-106A (OCL) c) ED-89A (D-ATIS) d) ARINC 623-3	ATSU and Aircraft
FMC WPR	Flight management computer waypoint position reporting (FMC WPR) ATS application, generates and sends waypoint position reports, supported by flight management system and ACARS.	ARINC 702A-3	Aircraft
ATSU CFRS	Communication service provider's (CSP's) centralized flight management computer waypoint reporting system (CFRS) enables ATSU to receive waypoint position reports in ICAO format from any FMC WPR aircraft.	a) ARINC 702A-3 b) CFRS Common Specification, Version 2.0, April 2004 (Available from ICAO Regional Office in Paris)	ATSU
ATSU AOC	Operator's aeronautical operational control (AOC) facility enables ATSU to receive waypoint position reports in ICAO format from the operator's FMC WPR aircraft.	a) ARINC 702A-3 b) Aeronautical fixed telecommunication network (AFTN) specifications	ATSU
ATSU CADS	CSP's centralized ADS-C system (CADS) enables an ATSU without FANS 1/A capability to receive ADS-C reports from any FANS 1/A, FANS 1/A+ or FANS 1/A ADS-C aircraft.	a) DO-258A/ED-100A, or previous versions. b) CADS Common Specification, Version 2.0, April 2004 (Available from ICAO Regional Office in Paris)	ATSU

Designator	Description of designator	Applicable interoperability standard(s)	Applicable system
FANS 1/A	Initial future air navigation system (FANS 1/A) ATS applications, AFN, CPDLC and ADS-C, supported by FANS 1/A over ACARS. <i>Note.— FANS 1/A typically involve communication (CPDLC), navigation (RNAV/RNP) and surveillance (ADS-C). This document refers to the FANS 1/A for the data link system, which includes the CPDLC and ADS-C applications. Refer to ICAO Doc 9613 for guidance material on navigation (RNAV/RNP) qualification and use.</i>	a) DO-258A/ED-100A, or previous versions. b) Boeing document D6-84207, Loading of ATC Clearances into the Flight Management System (FMS), August 2009 c) Airbus document X4620RP1133312, FANSA/A+ Function Integration with FMS Technical Report	ATSU and Aircraft
FANS 1/A+	Same as FANS 1/A, except with additional features, such as the message latency monitor function, described in DO-258A/ED-100A, paragraph 4.6.6.9. See also this document, paragraph 3.1.2.6 , for procedures on its use. FANS 1/A+ - complies with Revision A of the standard (i.e. not previous versions)	a) DO-258A/ED-100A only b) Boeing document D6-84207, Loading of ATC Clearances into the Flight Management System (FMS), August 2009 c) Airbus document X4620RP1133312, FANSA/A+ Function Integration with FMS Technical Report	Aircraft
FANS 1/A ADS-C	ATS applications, AFN and ADS-C, supported by FANS 1/A over ACARS. FANS 1/A ADS-C - complies with AFN and ADS-C applications, No CPDLC.	DO-258A/ED-100A	Aircraft

Designator	Description of designator	Applicable interoperability standard(s)	Applicable system
ATN B1	<p>ATS applications, CM and CPDLC, supported by aeronautical telecommunication network – baseline 1 (ATN B1):</p> <p>a) Context management (CM) application for data link initiation capability (DLIC);</p> <p>b) CPDLC for ATS communications management (ACM), ATS clearance (ACL), and ATC microphone check (AMC), except that:</p> <p>1) UM 135 CONFIRM ASSIGNED LEVEL and UM 233 USE OF LOGICAL ACKNOWLEDGEMENT PROHIBITED will not be used by the ATSU; and</p> <p>2) DM 38 ASSIGNED LEVEL (level) is not required by the aircraft.</p> <p><i>Note.— Interoperability for departure clearance (DCL), downstream clearance (DSC), data link – automatic terminal information service (D-ATIS), and flight plan consistency (FLIPCY) data link services, which are defined in DO-280B/ED-110B, are not supported.</i></p>	<p>a) DO-280B/ED-110B</p> <p>b) Eurocontrol Specification on Data Link Services (EUROCONTROL-SPEC-0116)</p>	ATSU and Aircraft
FANS 1/A – ATN B1	<p>Enables ATSU with ATN B1 ground system to provide data link service to FANS 1/A aircraft.</p> <p>Enables the use of CPDLC along a route of flight where data link services are provided by FANS 1/A technology in some airspaces and ATN B1 in other airspaces.</p>	<p>a) ATN B1 standards are applicable and, in addition,</p> <p>b) DO-305A/ED-154A</p> <p>a) ATN B1 and FANS 1/A standards are applicable and, in addition,</p> <p>b) DO-305A/ED-154A</p> <p><i>Note.— Some aircraft (see Appendix F, paragraph F.1) implement FANS 1/A and ATN B1 capabilities as separate systems and do not comply with ED154A/DO305A. Such aircraft do not benefit from automatic CPDLC transfers.</i></p>	<p>ATSU</p> <p>Aircraft</p>

Table 2-2. Designators for subnetworks

Designator	Description of designator	Applicable standard(s)
VDL M0/A	Very high frequency data link – mode 0/A	ARINC 618-6 (INTEROP) for air/ground protocol
VDL M2	Very high frequency data link – mode 2	a) ICAO Annex 10, Vol III b) ICAO Doc 9776, Manual on VDL Mode 2 c) RTCA DO-224C (MASPS) d) ARINC 631-6 (INTEROP)
HFDL	High frequency data link	a) ICAO Annex 10, Vol III b) ICAO Doc 9741, Manual on HF Data Link c) RTCA DO-265 (MASPS) d) ARINC 753-3 (INTEROP)
SATCOM (Inmarsat)	Inmarsat or MT-SAT – aero classic satellite communications	a) ICAO Annex 10, Vol III b) ICAO Doc 9925, AMS(R)S Manual c) RTCA DO-270 (MASPS) d) ARINC 741P2-11 (INTEROP)
SATCOM (Iridium)	Iridium short burst data satellite communications	a) ICAO Annex 10, Vol III b) ICAO Doc 9925, AMS(R)S Manual c) RTCA DO-270, Change 1 (MASPS) d) ARINC 741P2-11 (INTEROP)

2.1.3 Data link services – safety and performance specifications

2.1.3.1 Oceanic SPR Standard (RTCA DO-306/EUROCAE ED-122)

2.1.3.1.1 The *Safety and Performance Standard for Air Traffic Data Link Services in Oceanic and Remote Airspace* (Oceanic SPR Standard, RTCA DO-306/EUROCAE ED-122), provides operational, safety and performance criteria for data link services that are applicable in airspace, where procedural separation is being applied, for normal ATC communication and surveillance to support separation assurance, route conformance monitoring, re-routes, and weather deviation management. These criteria include specifications for required communication performance (RCP) and required surveillance performance (RSP), taking into consideration the following data link applications:

- a) Data link initiation capability (DLIC);
- b) CPDLC for ATC communication;
 - 1) RCP 240 operations; and
 - 2) RCP 400 operations;
- c) ADS-C for surveillance - automatic position reporting;
 - 1) RSP 180 operations; and
 - 2) RSP 400 operations;

d) FMC WPR for surveillance - automatic position reporting at ATC waypoints.

Note.— When RCP and RSP specifications are prescribed in Regional SUPPs, AIP (or other appropriate publication), the specifications are associated with any required interoperability (e.g. FANS 1/A or ATN B1) and functionality (e.g. ADS periodic and event contracts and parameter values to be used.)

2.1.3.1.2 If the data link operation is dependent on certain performance, then the ANSP may prescribe RCP and/or RSP specifications. [Table 2-3](#) provides examples of intended uses for which the RCP specifications defined in [Appendix B](#) are applicable. [Table 2-4](#) provides examples of intended uses for which the RSP specifications defined in [Appendix C](#) are applicable.

Table 2-3. Examples of applying RCP specifications to intended uses

RCP specification	Intended uses for which the RCP specification is applicable
RCP 240	When CPDLC is the normal means of communications supporting the application of separation minima predicated on communication performance (e.g. 30 NM lateral and 30 NM or 50 NM longitudinal).
RCP 400	When a technology other than HF voice radio is the normal means of communication and the ATS function specifies a requirement for RCP 400.
	When a technology other than HF voice radio is the alternative means of communication supporting the application of separation minima predicated on communication performance (e.g. 30 NM lateral and 30 NM or 50 NM longitudinal).

Table 2-4. Examples of applying RSP specifications to intended uses

RSP specification	Intended uses for which the RSP specification is applicable
RSP 180	When ADS-C is the normal means of surveillance supporting the application of separation minima predicated on surveillance performance (e.g. 30 NM lateral and 30 NM or 50 NM longitudinal).
RSP 400	When ADS-C or FMC WPR is the normal means of surveillance supporting the application of lateral separation greater than or equal to 50 NM and time-based longitudinal separation.
	When a technology other than HF voice radio provides an alternative means of surveillance (e.g. position reporting via satellite voice) supporting the application of separation minima predicated on surveillance performance (e.g. 30 NM lateral and 30 NM or 50 NM longitudinal).

Note 1.— For example, satellite voice and CPDLC over the HF DL subnetwork may provide ATC communication other than by HF voice radio. [Appendix B](#) and [Appendix C](#) provide criteria only when the communication is a data link system.

2.1.3.1.3 Data link operations that use certain subnetworks (e.g. HF DL) or take place in subnetwork transition areas (e.g. VHF fringe coverage area) may not meet the criteria for some RCP or RSP specifications.

2.1.3.1.4 Aircraft capability that supports multiple RCP and/or RSP operations needs to include appropriate indications and/or procedures to enable the flight crew to notify ATC when aircraft equipment failures result in the aircraft's inability to meet its criteria for any of the RCP or RSP specifications. (See [Appendix B](#) and [Appendix C](#).)

2.1.3.1.5 An ATSU that supports multiple RCP and/or RSP operations needs to include appropriate indications and/or procedures to enable the controller to notify all affected aircraft when infrastructure failures result in the ground system's inability to meet its criteria for any of the RCP or RSP specifications.

2.1.3.1.6 If no RCP or RSP specification is prescribed for the data link operation, then any subnetwork provided in [Table 2-2](#) is acceptable, unless otherwise prescribed by airspace requirements.

2.1.3.2 Continental SPR Standard (RTCA DO-290/EUROCAE ED-120)

2.1.3.2.1 The *Safety and Performance Standard for Air Traffic Data Link Services in Continental Airspace* (Continental SPR Standard, RTCA DO-290/EUROCAE ED-120, Change 1 and Change 2), provides operational, safety and performance criteria for data link services in airspace where ATS surveillance services (e.g. radar services) are provided and where certain specific criteria for sector densities and separation minima apply. Specific criteria for data link services to support ATS surveillance under circumstances where lower densities and/or higher minima apply would be locally assessed taking into consideration the appropriate safety and performance standards.

2.1.3.2.2 Data link operations that use certain subnetworks (e.g. VDL M0/A), or take place in subnetwork transition areas (e.g. VHF fringe coverage area), may not meet the performance criteria.

2.1.3.3 Performance-based communication and surveillance (PBCS)

2.1.3.3.1 Where beneficial, performance-based communication and surveillance performance is a concept that enables the management of communication and surveillance capabilities by prescription of RCP and RSP specifications (See [Appendix B](#) and [Appendix C](#)). When an ATS operation is predicated on communication and surveillance performance, RCP and RSP specifications provide operational requirements and allocations that apply to infrastructure as well as aircraft and operations. For example:

a) RCP 240 includes a four-minute time requirement for a controller capability to intervene with an aircraft; the requirement is specified from when the controller initiates the communication to when the controller receives the operational response from the flight crew; and

b) RSP 180 includes an accuracy requirement on the "position at time" based on the prescribed RNP/RNAV specification and a +/- one-second accuracy on Coordinated Universal Time (UTC). It also includes a time requirement from when the aircraft is at the compulsory reporting point to when the report is received by the controlling ATS unit.

Note.— RCP 240 and RSP 180 also include requirements associated with continuity, service availability, integrity and functionality.

2.1.3.3.2 Based on RCP and RSP, PBCS will enable:

- a) ICAO to specify communication and surveillance requirements for specific ATS operations (e.g. application of separation minimum) by reference to RCP and RSP specifications;
- b) Regions/States to prescribe RCP and RSP specifications in Regional Supplementary Procedures and Aeronautical Information Publications (AIPs or equivalent publication);
- c) Aircraft systems to be approved in accordance with prescribed RCP and RSP specifications;
- d) Operators to be authorized by the State of Registry or State of the Operator, as appropriate, and to file the prescribed performance based designators (e.g. RCP 240, RSP 180) in their flight plans;
- e) ANSPs to ensure infrastructure in accordance with prescribed RCP and RSP specifications and assess aircraft capability from flight plan information, to safely apply the appropriate ATS (e.g. reduced separation) to eligible aircraft; and
- f) ICAO Regions to conduct post-implementation monitoring of operational performance, in accordance with [Appendix D](#), against RCP and RSP specifications, and initiate corrective action to the appropriate party, as necessary, for continued operational safety. Operators will need to establish programs that support post-implementation monitoring activities.

2.1.4 Airspace types and their data link operational capabilities

Note 1.— Depending on airspace type, RTCA DO-306/EUROCAE ED-122 (see [section 2.1.3.1](#)) or RTCA DO-290/EUROCAE ED-120 (see [section 2.1.3.2](#)) can be considered for operational, safety and performance requirements.

Note 2.— Operational, safety and performance requirements applicable in an airspace are specified by the appropriate ATS authority.

2.1.4.1 Airspace where procedural separation is being applied

2.1.4.1.1 The data link system in airspace where procedural separation is being applied, as shown in [Figure 2-2](#), comprises a variety of ground systems that may provide data link services to FANS 1/A (generic) aircraft, FMC WPR aircraft and ACARS ATS aircraft.

2.1.4.1.2 The data link services improve communications, surveillance and route conformance monitoring to support operational capabilities that enable:

- a) Reduced separations, for example, in addition to navigation performance requirements, the following reduced separations require FANS 1/A aircraft, FANS 1/A ATSU, RCP 240 and RSP 180;
 - 1) 50 NM longitudinal separation;
 - 2) 30 NM longitudinal separation;
 - 3) 30 NM lateral separation;
- b) User preferred route (UPR) may require data link in some airspace;
- c) Re-route, may require data link in some airspace; dynamic airborne re-route procedure (DARP) requires FANS 1/A aircraft and FANS 1/A ATSU;
- d) Weather deviation management may require data link in reduced separation environments;

- e) More efficient air traffic management and increases in airspace capacity. For example, ADS-C provides automatic surveillance capability that an ANSP may use to replace CPDLC and/or voice position reporting; and
- f) Reduced flight crew workload through, for example, automatic position reporting and the ability to load clearance information directly into the flight management system.

2.1.4.2 Airspace where ATS surveillance services are provided

2.1.4.2.1 As shown in [Figure 2-2](#), the data link system in airspace where ATS surveillance services are provided comprises a variety of ground systems:

- a) ATN B1 ground systems, that may provide data link services to ATN B1 aircraft and FANS 1/A-ATN B1 aircraft;
- b) FANS 1/A-ATN ground systems, that may provide data link services to ATN B1 aircraft, FANS 1/A aircraft and FANS 1/A-ATN B1 aircraft;
- c) FANS 1/A ground systems, that may provide data link services to FANS 1/A aircraft, FANS 1/A+ aircraft and FANS 1/A-ATN B1 aircraft; and
- d) ACARS ATS ground systems, that may provide data link services to ACARS ATS aircraft.

Note.— *FANS 1/A aircraft are technically interoperable with a FANS 1/A-ATN ATSU. However, operationally, FANS-1/A+ may be required for data link operations in applicable airspace as specified in Regional SUPPs and/or AIP (or other appropriate publication, such as AIC or NOTAM). (refer to [Table 2-1](#)).*

2.1.4.3 Global overview of data link operational capabilities

2.1.4.3.1 [Table 2-5](#) provides an overview of the operational capabilities that are supported by each of the different data link systems.

Note.— *In [Table 2-5](#), the term “surveillance” includes conformance monitoring and conflict detection.*

Table 2-5. Types of data link systems and operations

Aircraft equipment and capability	ATSU ground data link system				
	ACARS ATS	CADS, CFRS or AOC	FANS 1/A	ATN B1	FANS 1/A–ATN B1
ACARS ATS	ATC communication <ul style="list-style-type: none"> • DCL or PDC • OCL Flight information <ul style="list-style-type: none"> • D-ATIS 	N/A	N/A	N/A	N/A
FMC WPR	N/A	Surveillance <ul style="list-style-type: none"> • FMC WPR (CFRS or AOC) 	N/A	N/A	N/A
FANS 1/A ADS-C	N/A	Surveillance <ul style="list-style-type: none"> • ADS-C (CADS) 	Surveillance <ul style="list-style-type: none"> • ADS-C 	N/A	N/A
FANS 1/A	N/A	Surveillance <ul style="list-style-type: none"> • ADS-C (CADS) 	ATC communication <ul style="list-style-type: none"> • CPDLC • ADS-C 	N/A	ATC communication <ul style="list-style-type: none"> • CPDLC for ACM, ACL, and AMC data link services
FANS 1/A+	N/A	Surveillance <ul style="list-style-type: none"> • ADS-C (CADS) 	ATC communication <ul style="list-style-type: none"> • CPDLC • ADS-C 	N/A	ATC communication <ul style="list-style-type: none"> • CPDLC for ACM, ACL, and AMC data link services
ATN B1	N/A	N/A	N/A	ATC communication <ul style="list-style-type: none"> • CPDLC for ACM, ACL, and AMC data link services 	ATC communication <ul style="list-style-type: none"> • CPDLC for ACM, ACL, and AMC data link services
FANS 1/A–ATN B1	N/A	Surveillance <ul style="list-style-type: none"> • ADS-C (CADS) 	ATC communication <ul style="list-style-type: none"> • CPDLC • ADS-C 	ATC communication <ul style="list-style-type: none"> • CPDLC for ACM, ACL, and AMC data link services 	ATC communication <ul style="list-style-type: none"> • CPDLC for ACM, ACL, and AMC data link services

2.2 Data link systems and services

2.2.1 Network descriptions and message acknowledgements

2.2.1.1 ACARS network and message acknowledgement

2.2.1.1.1 The FANS 1/A data link system (including FANS 1/A+, FANS 1/A ADS-C and FANS 1/A-ATN B1 defined in [paragraph 2.1.2](#)) relies on the ACARS network, which is provided and maintained by various communication service providers (CSPs).

2.2.1.1.2 The ACARS network evolved from the need to be able to exchange messages between an aircraft and its AOC.

2.2.1.1.3 The ACARS network consists mainly of VHF (VDL M0/A and VDL M2) and satellite subnetworks, but also includes the HFDL subnetwork. The performance characteristics of each subnetwork varies and its use for ATS communications will depend on the performance required for the intended operation (refer [paragraph 2.1.3](#)).

2.2.1.1.4 While there are no technical provisions to indicate to the ATSU that an uplink message is available for display to the flight crew, the ACARS network allows the ATSU to receive a message assurance (MAS) indicating that an uplink message has been delivered to the aircraft, as shown in [Figure 2-3](#).

Note.— It is possible that after successful delivery of an uplink message to the aircraft, the delivery of the associated MAS success response to the ATSU fails. Therefore, non-reception of a MAS-S by the ATSU is not necessarily a confirmation that the uplink was not delivered to the aircraft.

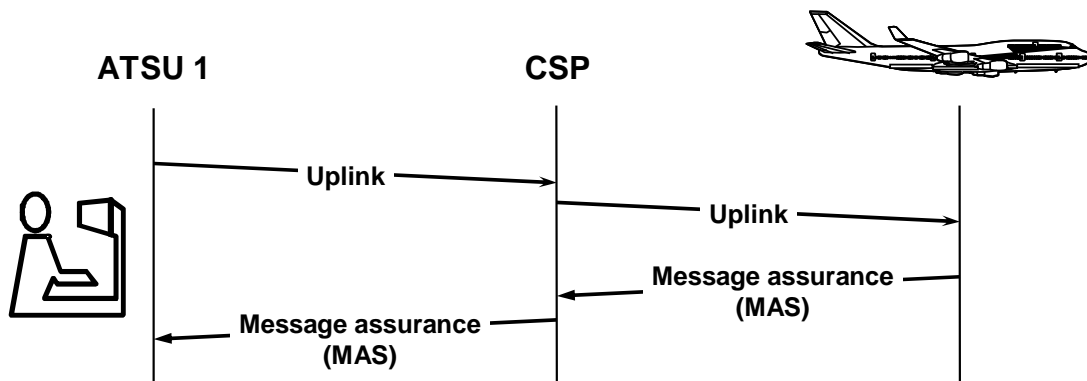

Figure 2-3. Uplink and message assurance

2.2.1.1.5 While there are no technical provisions to indicate to the aircraft that a downlink message has been delivered to the ATSU and is available for display to the controller, the ACARS network allows the aircraft to receive a network acknowledgement indicating that a downlink message has been delivered to the CSP system, as shown in [Figure 2-4](#).

Note 1.— Some aircraft may re-send the downlink if the network acknowledgement is not received within a given time. This may result in the ATSU receiving a duplicated downlink message.

Note 2.— In some cases, the aircraft may have sent a downlink message that was not received by the ATSU. For example, this is one reason the ATSU will not rely solely on some event reports, such as the lateral deviation event report, for protecting airspace.

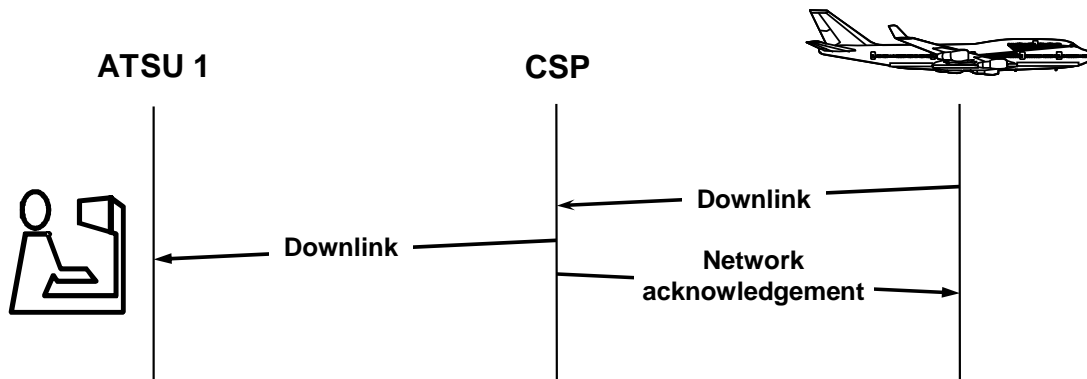

Figure 2-4. Downlink and network acknowledgement

2.2.1.1.6 As the controller does not have a means to ensure that a clearance was made available for display to the flight crew, procedures are in place to mitigate the effects of non-delivery (refer to [paragraph 4.3.1.2](#)).

2.2.1.2 ATN network and message acknowledgement

2.2.1.2.1 The ATN B1 data link system relies on the aeronautical telecommunication network (ATN), which is provided and maintained by various communication service providers (CSPs) and/or ANSPs.

2.2.1.2.2 The ATN was developed by ICAO to support the need for ATS communications.

2.2.1.2.3 The ATN relies only on VHF (VDL M2) to meet the performance required for the intended operations (refer [paragraph 2.1.3.2](#)).

2.2.1.2.4 There are technical provisions, as shown in [Figure 2-5](#) and [Figure 2-6](#), for the sender to ensure that a message has been delivered and made available for display to the receiver (end-to-end acknowledgement).

Note 1.— This acknowledgement mechanism is based on the use of dedicated CPDLC message elements (e.g. [UM 227](#) and [DM 100](#)). The ATS system (air or ground) will send a logical acknowledgement for any incoming message as long as it is requested by the sender (a dedicated field in each individual message allows the sender to indicate if LACK is required or not).

Note 2.— In areas where logical acknowledgements are not intended to be used, the ground system will instruct the aircraft:

a) By sending **UM 233 USE OF LOGICAL ACKNOWLEDGEMENT PROHIBITED**, not to require the **UM 227 LOGICAL ACKNOWLEDGEMENT** response for any future downlink message for the rest of the CPDLC connection; and

b) By specifying *LackNotRequired* within each of its uplink messages for the rest of the CPDLC connection, not to send a **DM 100 LOGICAL ACKNOWLEDGEMENT** message in response to the related uplink message.

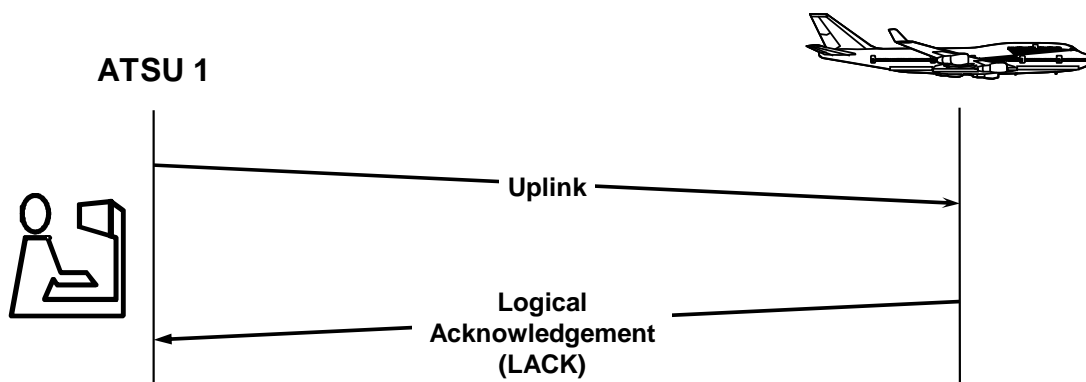

Figure 2-5. Uplink and logical acknowledgement

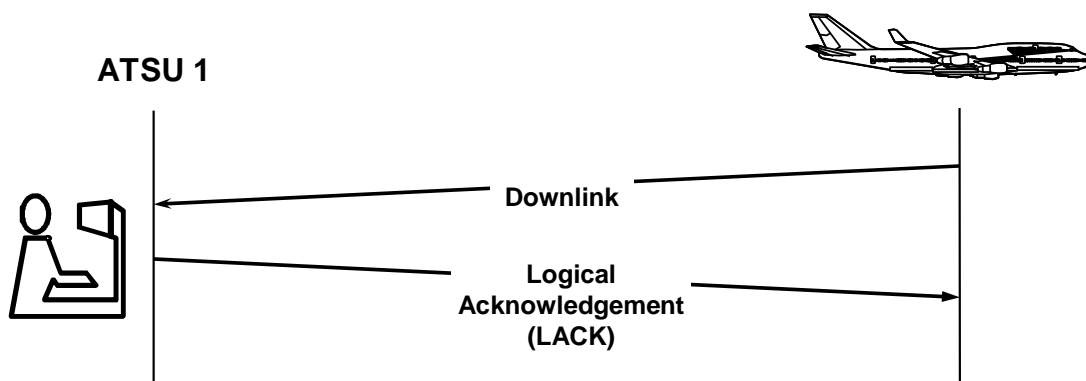

Figure 2-6. Downlink and logical acknowledgement

2.2.2 Data link messages

2.2.2.1 **Table 2-6** provides the list of air-ground data link messages that support the data link initiation capability service. It defines a generic term for each message that will be used in this document. It also provides the purpose and specific content for FANS 1/A and ATN B1 messages.

Table 2-6. Air-ground data link messages for DLIC

Generic Message Name	Purpose	FANS-1/A Messages	ATN B1 Messages
Air-ground logon procedure			
Logon Request	To provide the ATSU with information to confirm the identity of the aircraft and its data link capabilities, and to notify the ATSU of the flight crew's intention to use data link services.	FN_CON	CM_LOGON_REQUEST
Logon Response	To notify the aircraft of the status of its logon request.	FN_AK	CM_LOGON_RESPONSE
Air-ground address forwarding procedure			
Contact Request	To instruct the aircraft to send a logon request to the specified ATSU.	FN_CAD	CM_CONTACT
Contact Response	To indicate to the initiating ATSU that the logon request will be sent to the specified ATSU.	FN_RESP	No ATN equivalent
Contact Complete	To provide to the initiating ATSU the status of the logon request to the specified ATSU.	FN_COMP	CM_CONTACT_RESPONSE

2.2.2.2 [Table 2-7](#) provides the list of ground-ground data link messages that support the ground-ground coordination for address forwarding between initiating and receiving ATSUs.

Table 2-7. Ground-ground data link messages for DLIC

Generic Message Name	Purpose	AIDC	OLDI (See note)
Ground-ground address forwarding procedure			
Logon Forwarding	To provide an ATSU with logon information from an aircraft.	AIDC FAN	OLDI LOF
Next Authority Notified	To provide the receiving ATSU with the information that the aircraft has been notified about its next data authority. <i>Note.— This message is to prevent the receiving ATSU from attempting to establish a CPDLC connection prior to the NDA message being uplinked to the aircraft.</i>	No equivalent	OLDI NAN

Generic Message Name	Purpose	AIDC	OLDI (See note)
Ground-ground address forwarding procedure			
Connection Forwarding	To advise an ATSU that the transferring ATSU has terminated its CPDLC connection with the aircraft using a CPDLC Connection Status identifier (CPD =0). <i>Note.— This message can also be used to notify the status of the inactive connection.</i>	AIDC FCN	Not applicable.

Note.— OLDI is implemented in European Region to provide AIDC capability.

2.2.2.3 **Table 2-8** provides the list of data link messages that support the CPDLC connection. It defines a generic term for each message that will be used in this document. It also provides specific content and purpose for FANS 1/A and ATN B1.

Table 2-8. Data link messages for CPDLC connection

Generic Message Name	FANS-1/A Message	ATN B1 Message
CPDLC Connection Establishment		
Connection Request	CR1 containing UM 163 [<i>icao facility designation</i>] [<i>tP4+Table</i>]	CPDLC_START_REQUEST
Connection Rejection	DR1 optionally containing error message element DM 64 [<i>facility designation</i>]	CPDLC_START_CONFIRM (rejected) and optionally containing error message element DM 107 NOT AUTHORIZED NEXT DATA AUTHORITY
Connection Confirm	CC1 containing DM 73 [<i>version number</i>]	CPDLC_START_CONFIRM (accepted)

Generic Message Name	FANS-1/A Message	ATN B1 Message
CPDLC Connection Termination		
Termination Request	CPDLC message containing UM 161 END SERVICE and optionally a CONTACT or MONITOR message element. <i>Note 1.— Under normal circumstances, FANS 1/A ATSU will send a CONTACT or MONITOR message and then the termination request message containing UM 161 END SERVICE message element only.</i> <i>Note 2.— Under normal circumstances, FANS 1/A-ATN B1 ATSU will send a termination request message containing both UM 161 END SERVICE message element and a CONTACT or MONITOR message element.</i>	CPDLC_END_REQUEST and optionally containing a CONTACT or MONITOR message element.
Termination Rejection	CPDLC message containing: DM 63 NOT CURRENT DATA AUTHORITY, or if a CONTACT or MONITOR message is included in the termination request, DM 1 UNABLE	CPDLC_END_CONFIRM (rejected) containing: DM 63 NOT CURRENT DATA AUTHORITY, or if a CONTACT or MONITOR message is included in the termination request, DM 1 UNABLE
Termination Confirmation	DR1	CPDLC_END_CONFIRM (accepted) containing DM 0 WILCO
CPDLC Connection Abort		
Abort Request (downlink)	DR1	USER_ABORT
Abort Request (uplink)	CPDLC message containing UM 161 END SERVICE and UM 159 ERROR (commanded termination).	USER_ABORT

2.2.3 Data link initiation capability (DLIC)

2.2.3.1 Purpose of the logon (flight plan correlation)

2.2.3.1.1 The logon is the first step in the data link process. A logon, initiated either by the flight crew or by another ATSU, is performed prior to the ATSU establishing a CPDLC and/or ADS-C connection. The purpose of the logon is to:

- a) Provide the ATSU with the data link application “context” of the aircraft, namely:
 - 1) The ATS data link applications supported by the aircraft system (e.g. CPDLC, ADS-C) and the associated version numbers of these applications; and
 - 2) The unique identification of the aircraft;
- b) Provide the ATSU with the relevant aircraft information required to allow the ATSU to correlate the logon information with the aircraft’s corresponding flight plan.

Note 1.— For FANS I/A, the unique identification of the aircraft is the aircraft registration and/or aircraft address; for ATN B1 the unique identification of the aircraft is the aircraft address.

Note 2.— Under certain circumstances, it may be operationally desirable for an ATSU to set up an ADS-C connection (perhaps for a single demand contract) without a preceding logon. When this is done, correlation with the flight plan can be achieved by requesting the optional flight identification group and checking this against the aircraft registration in the flight plan. See also [section 4.5.3](#) for guidelines on ADS-C connection management.

2.2.3.1.2 On receipt of a logon request, the ATSU correlates the logon information with the relevant information in the flight plan held by the ATSU. This ensures that messages are sent to the correct aircraft and that automation associated with ADS-C reports or CPDLC messages updates the correct flight plan.

2.2.3.1.3 When making this correlation, the ground system:

- a) Ensures that the aircraft identification in the logon request matches that in Item 7 of the associated flight plan and at least one of the aircraft registration or aircraft address provided match the corresponding descriptors (following the REG and/or CODE indicators, respectively) in Item 18 of the flight plan; and
- b) Only uses the information contained within the portion of the logon request message that is protected by the cyclic redundancy check (CRC).

Note 1.— The data used for correlation are:

- a) For FANS-I/A, the aircraft identification, aircraft registration, and optionally, the aircraft’s current position (lat/long) and the aircraft address (if available);
- b) For ATN B1, the aircraft identification, departure and destination airports, the aircraft address, and optionally estimated off-block time (EOBT), if available.

Note 2.— For FANS I/A, the aircraft identification in the ACARS message header is not protected by the CRC and the flight crew does not use this information to verify aircraft identification. Additionally, the format for the aircraft identification in the ACARS message header is different from the format used by the ground system. For example, the ground system uses a three alpha character ICAO designator for the operating agency followed by up to four numeric characters for the flight identification.

FANS 1/A Example

The following example of an AFN logon indicates the appropriate information in the ACARS message to correlate the AFN logon with a flight plan.

```
QU <ACARS "TO" address>
.<ACARS "FROM" address> 010000
AFD
FI AB0123/AN ST-XYZ
DT QXT POR1 010000 J59A
- AFN/FMHABC123,ST-XYZ,DEF456,000002/FPOS30000E160000,0/FCOADS,01/
FCOATC,01<CRC>
```

The ATSU only uses the information in the CRC-protected portion of the ACARS message. In the example above, the CRC portion is highlighted, and contains the following information:

- aircraft identification is ABC123 (not the AB0123 contained in the ACARS header);
- aircraft registration is ST-XYZ (hyphen is removed by ATS automation per [paragraph 3.1.2.1.2](#)); and
- aircraft address is DEF456.

Note.— Some ATSUs may operate a ground system that does not integrate data link capability with a flight data processing system. Under these circumstances, the ATSU will need to ensure that the logon information is available for the controller to manually cross-check the information with the details in the flight plan.

ATN B1 Example

The following example of a CM logon indicates the appropriate information in the CM message to correlate the CM logon with a flight plan.

CMLogonRequest

aircraftFlightIdentification	ABC123
cMLongTSAP	ATN address of the aircraft CM application (string of 18 or 19 octets), including the aircraft address DEF456 (3 octets).
groundInitiatedApplications	1 (CMA) and 22 (PM-CPDLC)
airOnlyInitiatedApplications	1 (CMA)
facilityDesignation	None
airportDeparture	LFBO
airportDestination	ENGM

dateTimeDepartureETD	None
<p>The ATSU only uses the information in the CRC-protected portion of the message:</p> <ul style="list-style-type: none"> • aircraft identification is ABC123; • aircraft address is DEF456 and is included in the cMLongTSAP; and • departure airport is LFBO (Toulouse) and destination airport is ENGM (Oslo). <p><i>Note.</i>— <i>The facilityDesignation field would be used to require a logon to a facility different from the one to which the logon request will be addressed. Such capability (commonly referred to as DLIC server) is not implemented by ATN B1 systems.</i></p>	

2.2.3.2 Initial logon request

2.2.3.2.1 An initial logon request is needed when the aircraft does not already have an ADS-C or CPDLC connection, such as when:

- a) The aircraft is preparing for departure; or
- b) The aircraft will enter an area where data link services are available from an area where data link services are not available; or
- c) Instructed by ATC (e.g. following a failed data link transfer).

2.2.3.2.2 To perform an initial logon request, the flight crew enters the four character ICAO identifier of the ATSU to which the logon request is to be sent and includes the following flight-specific information:

- a) Aircraft identification (same as item 7 of the flight plan);
- b) Aircraft registration and/or aircraft address (same as item 18, preceded by REG and/or CODE, of the flight plan); and
- c) Departure and destination aerodromes, when required (same as items 13 and 16 of the flight plan).

Note 1.— *In accordance with ICAO Doc 4444, the aircraft identification entered into the aircraft system is either the ICAO designator for the aircraft operating agency followed by the flight identification or the aircraft registration.*

Note 2.— *The aircraft identification and registration may have been loaded prior to departure.*

Note 3.— *When the aircraft identification includes a numeric component, this component matches exactly that included in the flight plan. In other words, “ABC3” does not match “ABC003.”*

Note 4.— *While the ATSU identifier is only 4-characters, ATN B1 is capable of supporting up to 8 characters.*

2.2.3.2.3 To avoid an automatic rejection of the logon request, the flight crew ensures that the flight-specific information entered into the aircraft system is the same as the corresponding details filed in the flight plan.

2.2.3.2.4 When the flight crew performs the logon request, the aircraft system transmits the logon information in a logon request message (as per [Table 2-6](#)) to the specified ATSU.

Note.— The flight crew procedure for performing an initial logon request is provided in [paragraph 5.2](#).

2.2.3.3 Logon response

2.2.3.3.1 As shown in [Figure 2-7](#), the ground system automatically responds to a logon request with a logon response (as per [Table 2-6](#)). The logon response message provides information to the aircraft system concerning whether:

- a) The logon request was successful (e.g. could be correlated with a flight plan); or
- b) The logon request was unsuccessful (e.g. could not be correlated with a flight plan). Refer to [paragraph 3.1.2.1.1](#) for conditions when an ATSU rejects a logon request.

2.2.3.3.2 The logon response message also provides information concerning the ATS data link applications the ATSU supports.

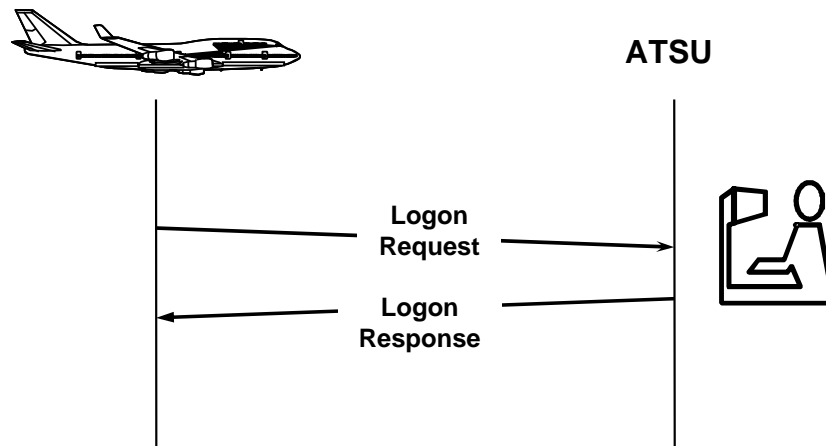

Figure 2-7. Initial logon exchanges

2.2.3.4 Logon request triggered by contact request

2.2.3.4.1 The air-ground address forwarding procedure is the process whereby one ATSU instructs the aircraft system to initiate a logon request to another ATSU (e.g. when the flight is leaving one ATSU where a logon had already been completed and the flight is transferred to another ATSU).

2.2.3.4.2 When triggered by a contact request, a logon request is initiated without flight crew input.

2.2.3.4.3 The CDA typically initiates address forwarding to permit a downstream or adjacent ATSU (NDA) to establish an inactive CPDLC connection and/or an ADS contract for monitoring purposes.

2.2.3.4.4 Any ATSU can initiate address forwarding by sending a contact request message to the aircraft. Upon receipt, the aircraft automatically transmits a logon request to the ATSU whose address was included in the contact request message.

Note.— Some aircraft will not accept a CPDLC connection with an ATSU to which they have been instructed to log on unless the ATSU issuing the instruction had itself established a CPDLC connection with the aircraft. Refer to [Appendix F, paragraph F.3](#).

2.2.3.4.5 The messages associated with address forwarding are listed in [Table 2-6](#), and the sequence is depicted in [Figure 2-8](#).

Note 1.— Only FANS 1/A aircraft will send a contact response message to the initiating ATSU.

Note 2.— For some ATN B1 aircraft, the contact complete message indicates a positive result even though the logon response from the receiving ATSU indicated failure.

2.2.3.4.6 The ATSU initiating the address forwarding procedure receives an indication of the status of the air-ground logon procedure with the specified ATSU upon receipt of the contact complete message.

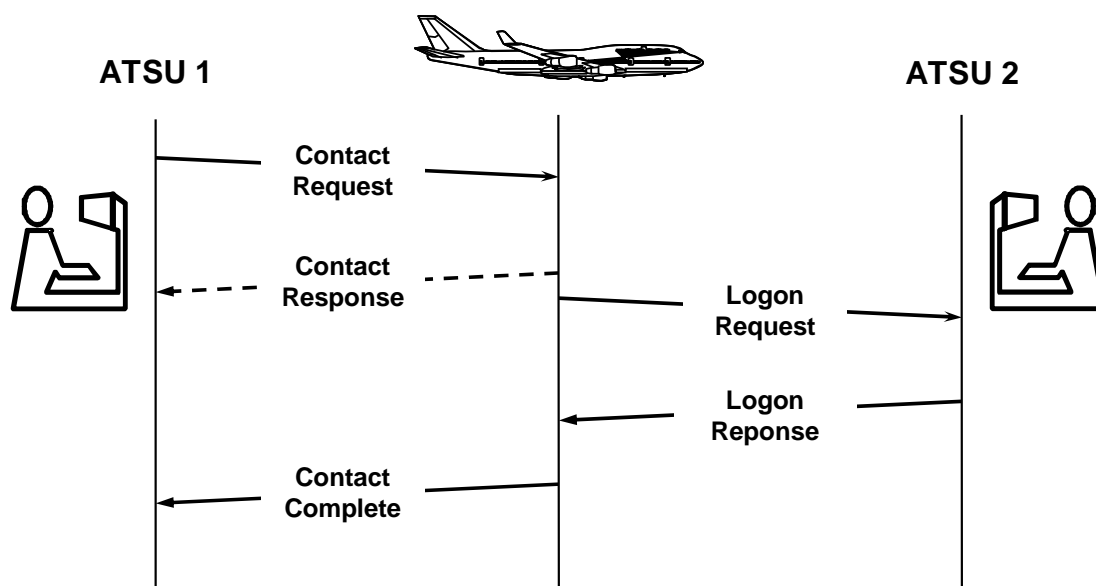

Figure 2-8. Air-ground address forwarding message sequence (Transfer between areas where data link is provided)

2.2.3.4.7 Where the functionality is available, an ATSU can imitate the air-ground address forwarding procedure with a ground-ground address forwarding procedure that uses messages listed in [Table 2-7](#). The logon forwarding message contains the same information as a logon request, but is transmitted by one ATSU to another as depicted in [Figure 2-9](#).

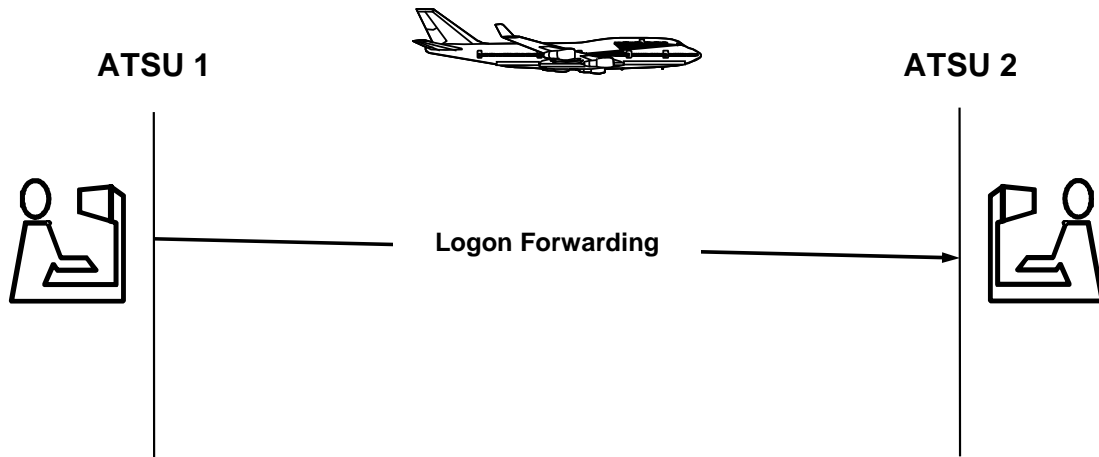

Figure 2-9. Ground-ground address forwarding using logon forwarding message

2.2.4 CPDLC connection management

2.2.4.1 Purpose of a CPDLC connection

2.2.4.1.1 The purpose of a CPDLC connection is to allow the exchange of CPDLC messages between an aircraft and an ATSU (active connection), and also to provide an advance connection with the next ATSU (inactive connection). An aircraft can have a maximum of two CPDLC connections established concurrently, each with a different ATSU. Only one CPDLC connection can be active at any given time; any second connection is inactive.

2.2.4.2 Active and inactive CPDLC connections

2.2.4.2.1 An active CPDLC connection can be established upon completion of the logon procedure if no previous CPDLC connection exists with the aircraft. An active CPDLC connection allows an ATSU and the aircraft to exchange CPDLC messages. The ATSU with which an aircraft has an active CPDLC connection is referred to as the CDA.

Note.— In some circumstances an active connection may not be operational (e.g. the connected ATSU is not controlling the aircraft). Refer to [paragraph 4.9.4.1](#) and [paragraph 5.2.2.2](#).

2.2.4.2.2 An inactive CPDLC connection can be established upon completion of the logon procedure if a previous CPDLC connection exists with the aircraft. The ATSU and the aircraft cannot exchange CPDLC messages when the CPDLC connection is inactive. The ATSU with an inactive CPDLC connection is referred to as the next data authority (NDA).

2.2.4.3 Establishing a CPDLC connection

2.2.4.3.1 The ATSU can only initiate a CPDLC connection request after successfully correlating an aircraft with the associated flight plan ([paragraph 2.2.3.1](#) refers).

Note.— Flight plan correlation can occur as the result of the air-ground address forwarding procedure, or as the result of ground-ground address forwarding procedure. The connection request can generally be sent automatically by the ATSU system, or manually by the controller. Depending on the functionality of the ground system, the ATSU may send the connection request upon completion of a successful logon procedure, or at some later time (e.g. as the aircraft approaches the ATSU's airspace, or manually by the controller).

2.2.4.3.2 The ATSU initiates a CPDLC connection by sending a CPDLC connection request to the aircraft as shown in [Figure 2-10](#).

2.2.4.3.3 Provided there is no existing CPDLC connection, the aircraft system:

- a) Accepts the connection request;
- b) Establishes this CPDLC connection as the active connection; and
- c) Responds with a CPDLC connection confirm.

Note.— If the logon procedure was not successful with the requesting ATSU, some aircraft will reject the CPDLC connection request. Refer to [Appendix F, paragraph F.3](#).

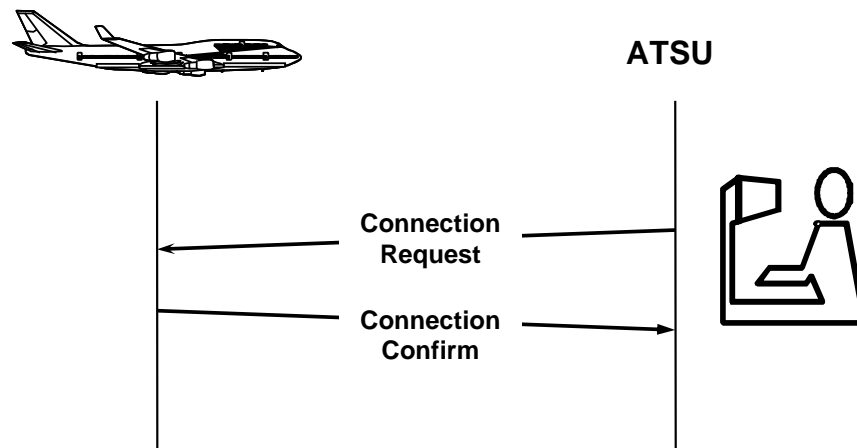

Figure 2-10. CPDLC connection sequence

2.2.4.3.4 If there is an existing CPDLC connection when a CPDLC connection request is received, the aircraft system verifies that the ATSU sending the CPDLC connection request has been specified as the next data authority. In this case, as shown in [Figure 2-11](#), the aircraft system:

- a) Accepts the CPDLC connection request;
- b) Establishes the connection, which is inactive; and
- c) Responds with a CPDLC connection confirm.

Otherwise, the aircraft system rejects the CPDLC connection request by sending a connection rejection message.

Note.— In addition to the connection rejection message, FANS 1/A aircraft will include the identity of the CDA, while ATN B1 aircraft will include **DM 107** NOT AUTHORIZED NEXT DATA AUTHORITY, notifying that the ATSU is not the authorized NDA.

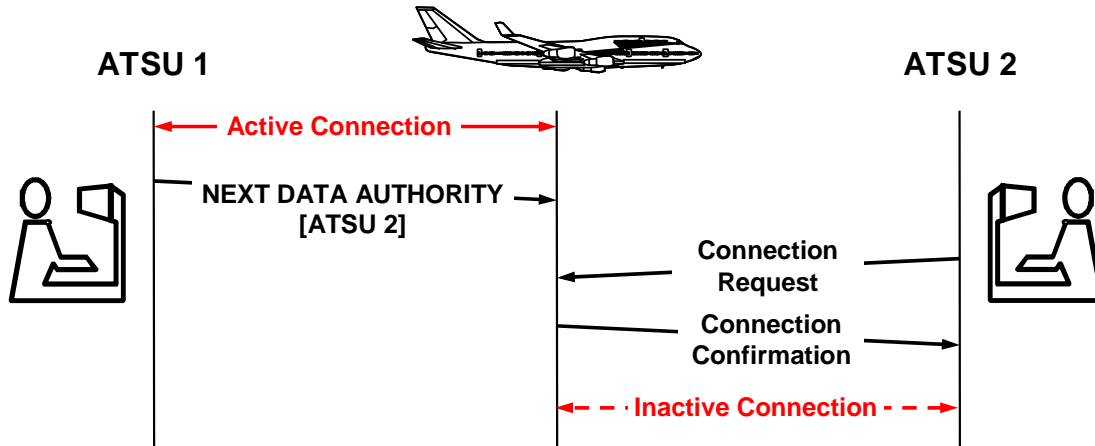

Figure 2-11. Successful attempt to establish a CPDLC connection (inactive)

2.2.4.4 Terminating a CPDLC connection (termination request message)

2.2.4.4.1 The CDA initiates the termination of the CPDLC connection by sending a termination request message (Table 2-8 refers) to the aircraft as depicted in Figure 2-12.

Note.— A ground system can only terminate an active CPDLC connection. It is not possible for the ground system to terminate an inactive CPDLC connection.

2.2.4.4.2 On receipt of a termination request message (without any additional message elements), the aircraft system will downlink a CPDLC termination confirmation message. The aircraft system will consider the aircraft to be disconnected as soon as the termination confirmation message has been sent.

2.2.4.4.3 On receipt of a termination request message containing a CONTACT or MONITOR message element as per Table 2-8, the aircraft system will:

- a) Display the message contained in the termination request message for flight crew processing; and
- b) If the flight crew responds with **DM 0** WILCO, send a CPDLC termination confirmation message containing **DM 0** WILCO and then consider the aircraft to be disconnected.

Note 1.— In case the flight crew sends an **DM 1** UNABLE response to the message, the aircraft system sends a CPDLC termination rejection message containing **DM 1** UNABLE and maintains the CPDLC connection with the CDA (and the next data authority, if any).

Note 2.— Any CPDLC termination request message that would contain a message with a response attribute different from **DM 0** or **DM 1** would be considered as a CPDLC abort request by the aircraft

system. This would cause all CPDLC connections to be aborted by the aircraft system, leading to the failure of the transfer of CPDLC connections.

2.2.4.4.4 If the next data authority attempts to uplink a termination request message to the aircraft, the aircraft system will maintain the inactive CPDLC connection and send a termination rejection message including **DM 63** NOT CURRENT DATA AUTHORITY.

Note.— Some aircraft may include the MRN in the termination rejection message.

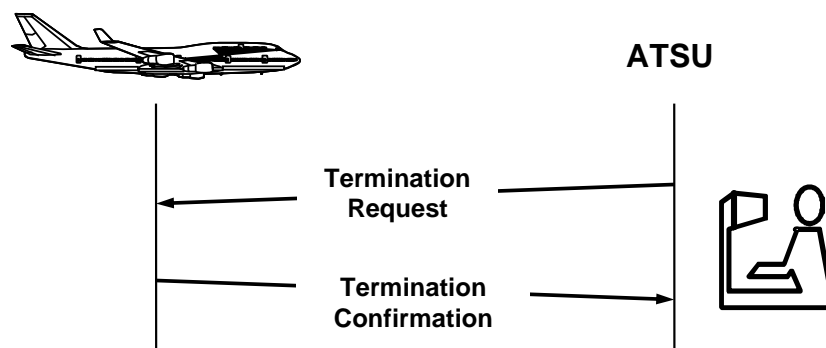

Figure 2-12. Termination of the CPDLC connection

2.2.4.5 Transferring CPDLC connections

2.2.4.5.1 ATSUs manage CPDLC connections to ensure that the ATSU with control for the flight holds the active CPDLC connection, except in certain circumstances. (See [paragraph 4.2.1.1](#)). The flight crew can also terminate a CPDLC connection. (See [paragraph 5.2.5](#)).

2.2.4.5.2 Under normal circumstances, the CDA will initiate a CPDLC transfer to an adjacent ATSU as the aircraft transits from the current ATSU to another CPDLC-capable ATSU. These transfers are normally automatic, without flight crew action.

Note 1.— [Paragraph 2.2.4.8](#) provides non-standard events associated with CPDLC transfers that may require controller action per [paragraph 4.2](#) and/or the flight crew action per [paragraph 5.2.3](#).

Note 2.— Material for CPDLC connection transfers in the document are applicable independently of the supporting technology (e.g. FANS or ATN B1).

2.2.4.5.2.1 The CDA performs the following steps in the exact order listed to transfer a CPDLC connection to the next ATSU:

- a) Sends a NDA message to notify the aircraft of the identity of the next ATSU permitted to establish a CPDLC connection;
- b) Initiates address forwarding with the next ATSU; and
- c) Sends a CPDLC termination request message when the aircraft is in the vicinity of the boundary with the next ATSU.

Note.— The aircraft system will only accept a CPDLC connection request from the ATSU specified in the NDA message.

2.2.4.5.2.2 Only the CDA can specify the next data authority by including the four-character ICAO identifier for the appropriate ATSU in the NDA message, as shown in [Figure 2-13](#).

Note.— ATSU 1 may optionally send a ground-ground next authority notified message.

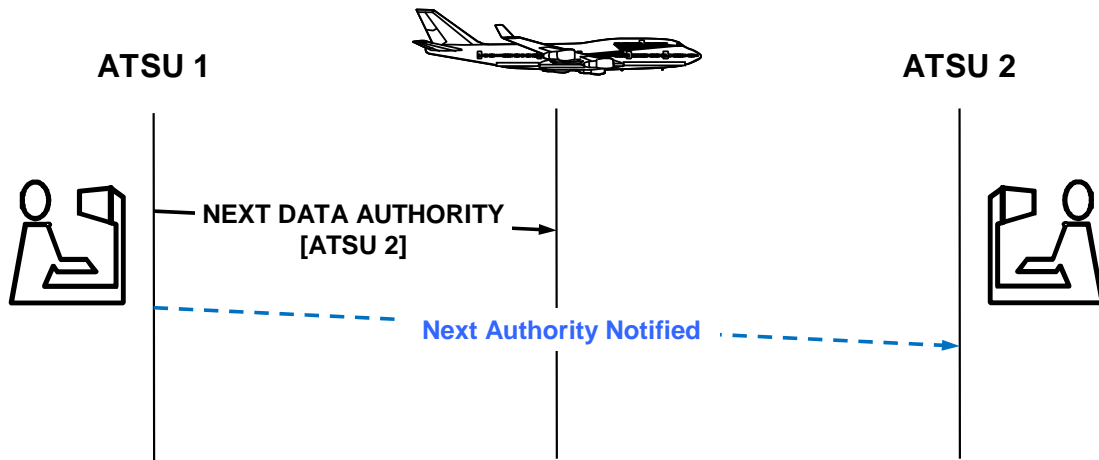

Figure 2-13. Next data authority notification

2.2.4.5.2.3 When the active CPDLC connection is terminated, the aircraft will activate any inactive connection. In this case, the next data authority becomes the CDA and is now able to exchange CPDLC messages with the aircraft.

2.2.4.5.2.4 ATSU 1 may use the connection forwarding message described in [paragraph 2.2.2.2](#), to provide notification to the next ATSU that ATSU 1 has terminated its CPDLC connection, as depicted in [Figure 2-14](#).

Note.— If the connection forwarding message is not used, then when a CPDLC connection has been transferred between ATSUs:

a) For FANS 1/A aircraft, the new ATSU (CDA) has no indication that it has the active CPDLC connection until a CPDLC downlink is received from the aircraft (See [paragraph 2.2.4.7.3](#)).

b) For ATN B1 aircraft, the new ATSU (CDA) has an indication that it has the active CPDLC connection (See [paragraph 2.2.4.7.2](#)).

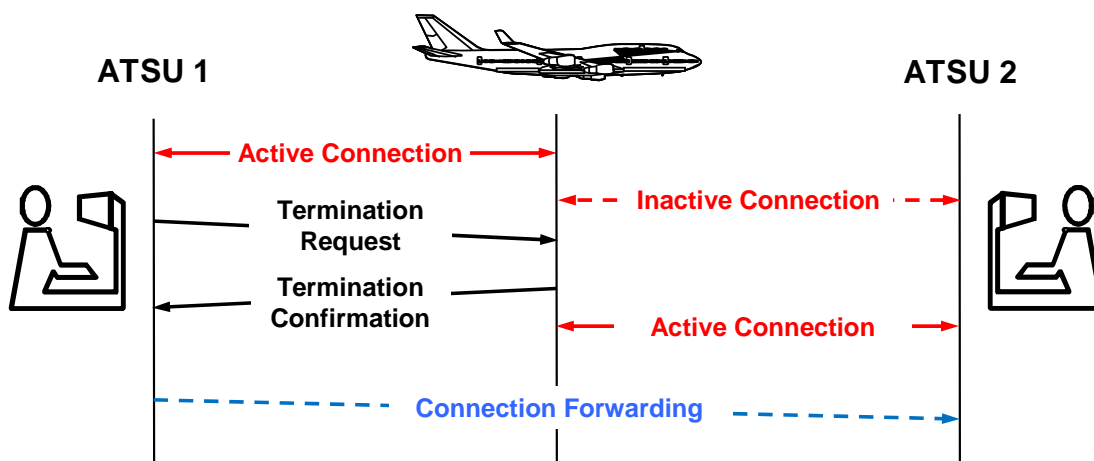

Figure 2-14. Connection forwarding

2.2.4.5.2.5 A successful CPDLC transfer is dependent upon the next ATSU establishing its own CPDLC connection prior to the termination request message being received by the aircraft.

2.2.4.5.2.6 Failure of the next ATSU to establish a CPDLC connection before the termination request message reaches the aircraft will have the following consequence:

- a) The aircraft will not have CPDLC connectivity and the previous ATSU will no longer be able to exchange CPDLC messages with the aircraft, and,
- b) The first ATSU to send a CPDLC connection request message to the aircraft will become the CDA.

Note.— Some FANS I/A aircraft may require a logon request to be completed with that ATSU before it can accept the connection request. See [Appendix F, paragraph F.14](#).

2.2.4.5.3 If the aircraft is entering an airspace where data link services are not provided, no NDA message is sent, nor is the address forwarding process performed.

2.2.4.5.3.1 When the active CPDLC connection is terminated, the aircraft will no longer have a CPDLC connection.

2.2.4.6 The CPDLC connection sequence

2.2.4.6.1 As the aircraft transits from one CPDLC-capable ATSU to another, the same CPDLC transfer process is repeated. The cyclical nature of this process is depicted in [Figure 2-15](#).

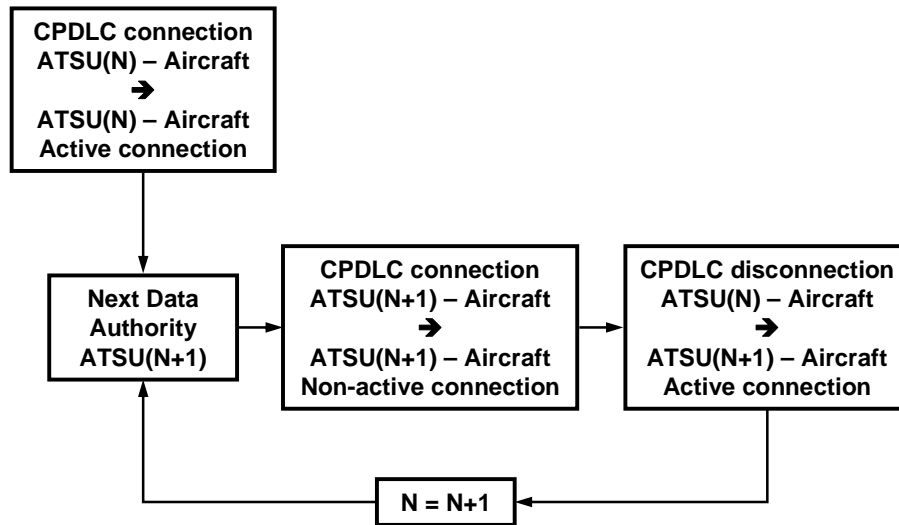

Figure 2-15. Life cycle of the CPDLC connection process

2.2.4.6.2 The sequence of messages from the logon request to the completion of the CPDLC transfer when using air-ground address forwarding is depicted in [Figure 2-16](#).

Note.— Only FANS 1/A aircraft will send Contact Response message to the initiating ATSU.

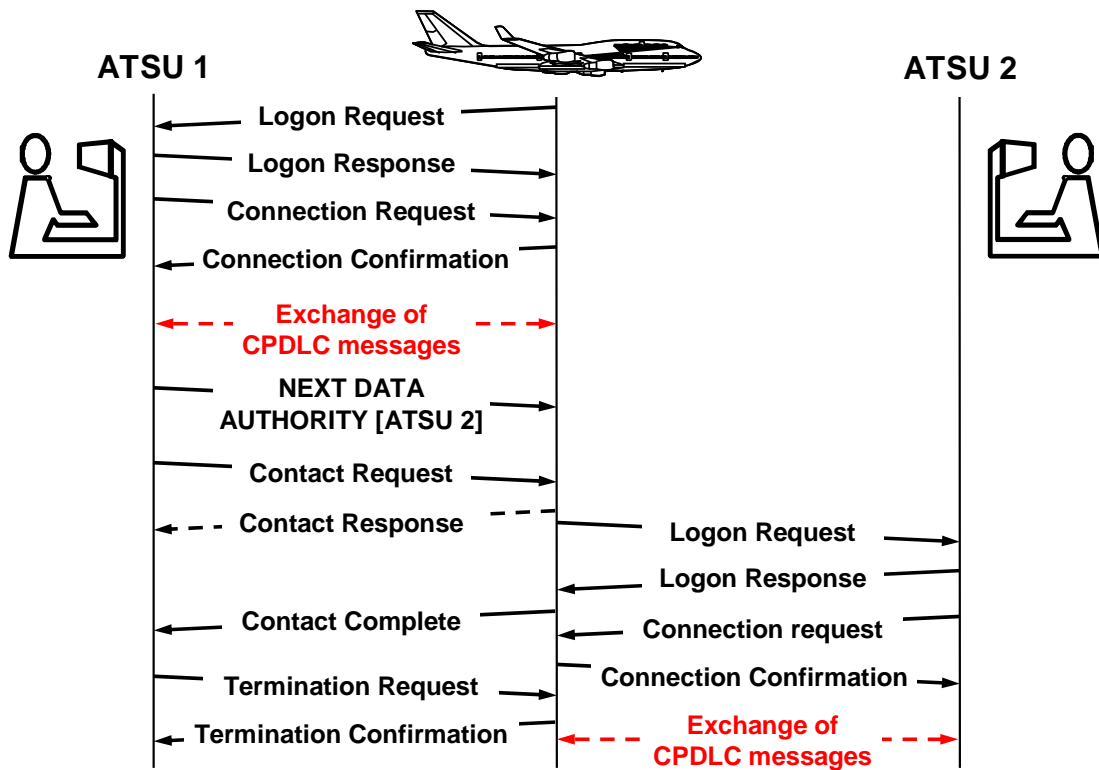

Figure 2-16. Nominal sequence for initial CPDLC connection establishment and transfer of CPDLC connection using air-ground address forwarding

2.2.4.6.3 The sequence of messages from the logon request to the completion of the CPDLC transfer when using ground-ground address forwarding (no use of Next Authority Notified) is depicted in [Figure 2-17](#).

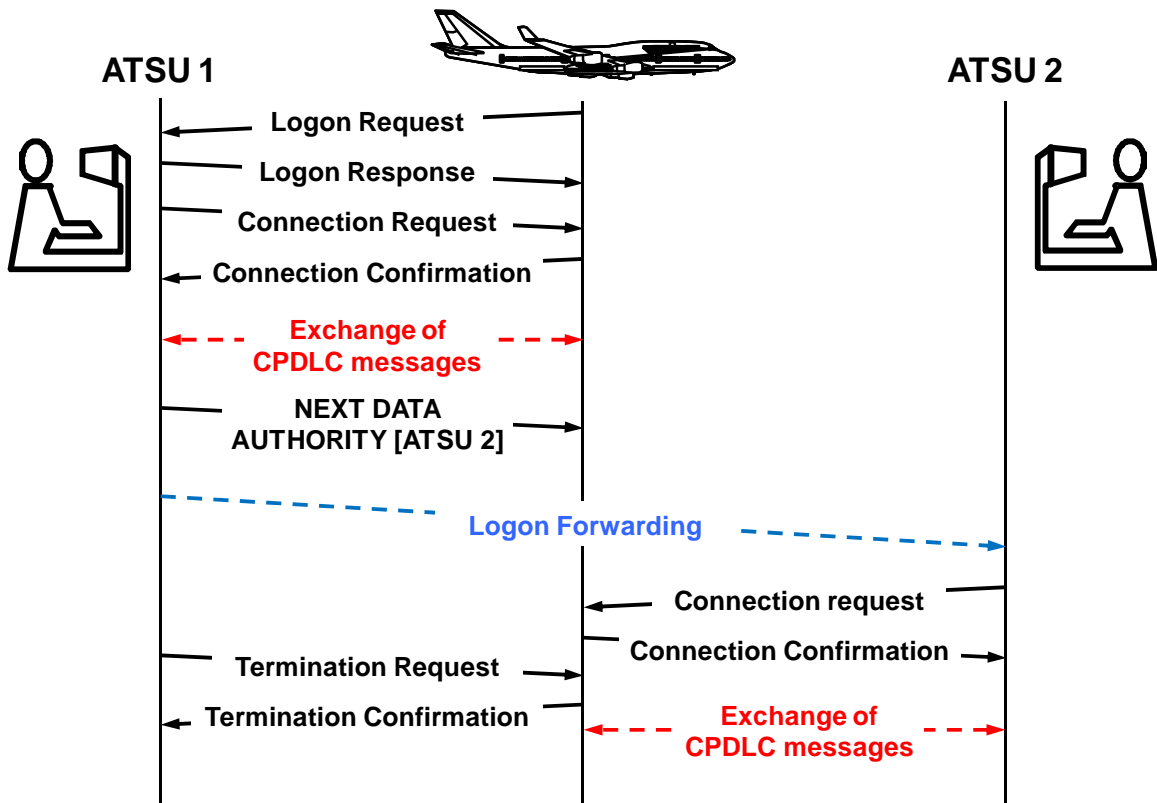

Figure 2-17. Nominal sequence for initial CPDLC connection establishment and transfer of CPDLC connection using ground-ground address forwarding (no use of Next Authority Notified)

2.2.4.6.4 The sequence of messages from the logon request to the completion of the CPDLC transfer when using ground-ground address forwarding (use of Next Authority Notified) is depicted in [Figure 2-18](#).

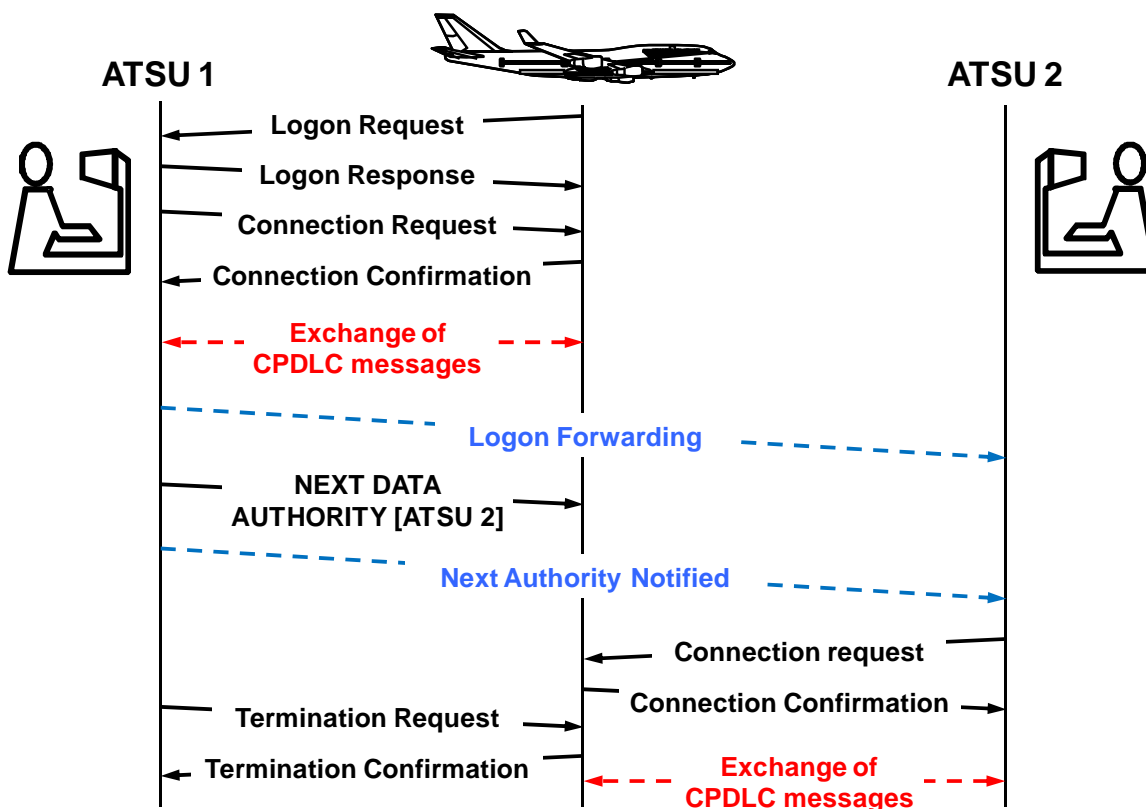

Figure 2-18. Nominal sequence for initial CPDLC connection establishment and transfer of CPDLC connection using ground-ground address forwarding (use of Next Authority Notified)

2.2.4.7 Determining an active CPDLC connection

2.2.4.7.1 CPDLC messages can only be exchanged between the aircraft and the CDA. If the ATSU with the inactive connection uplinks a CPDLC message to the aircraft, the aircraft system rejects the message by sending **DM 63** NOT CURRENT DATA AUTHORITY to the ATSU (Refer to **Figure 2-19**).

2.2.4.7.2 As soon as the CPDLC connection becomes active, ATN B1 aircraft will notify the CDA by sending **DM 99** CURRENT DATA AUTHORITY.

Note.— A FANS 1/A aircraft does not provide such automated capability.

2.2.4.7.3 When connected with a FANS 1/A aircraft, the receiving ATSU can use the following methods to confirm a CPDLC connection is active:

- Wait until a CPDLC downlink message is received from the aircraft per **paragraph 5.2.3.5**; or
- Wait until the ground-ground connection forwarding message for the flight is received from the transferring ATSU (if in use between the ATSUs); or

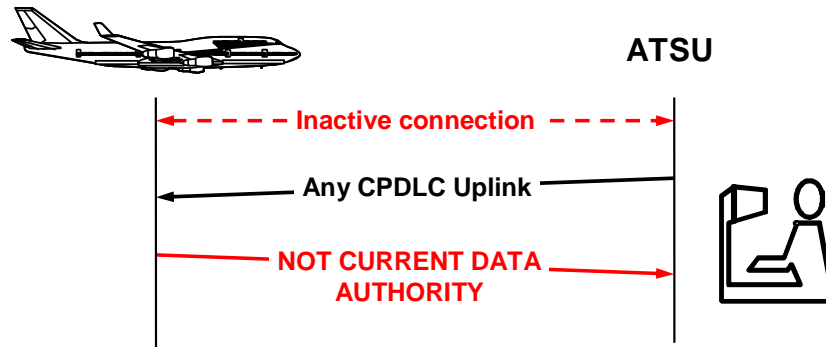

Figure 2-19. Rejection of CPDLC uplinks from the NDA

2.2.4.8 Non-standard events associated with CPDLC transfers

2.2.4.8.1 Multiple NDA messages

2.2.4.8.1.1 Under normal circumstances, the CDA sends only a single NDA message to an aircraft. Exceptions to this may include:

- a) Following a re-route (e.g. due to weather) that affects the identity of the next ATSU whose airspace the aircraft will enter; or
- b) If the initial NDA message was not delivered to the aircraft.

2.2.4.8.1.2 When a NDA message is received, the aircraft system replaces any previous NDA message the aircraft may have received unless the facility designation in the message is the same as the facility designation already held by the aircraft system. If the facility designation is different, the aircraft terminates any inactive CPDLC connection that an ATSU may have established.

Note.— Some aircraft types may terminate an inactive CPDLC connection even if the facility designation in the NDA message is the same. See [Appendix F, paragraph F.3](#).

2.2.4.8.1.3 In [Figure 2-20](#), the next ATSU on the aircraft's route was ATSU 2. Shortly after ATSU 1 had commenced the CPDLC transfer sequence to ATSU 2, the aircraft was re-routed in such a way that ATSU 3 is now the next ATSU.

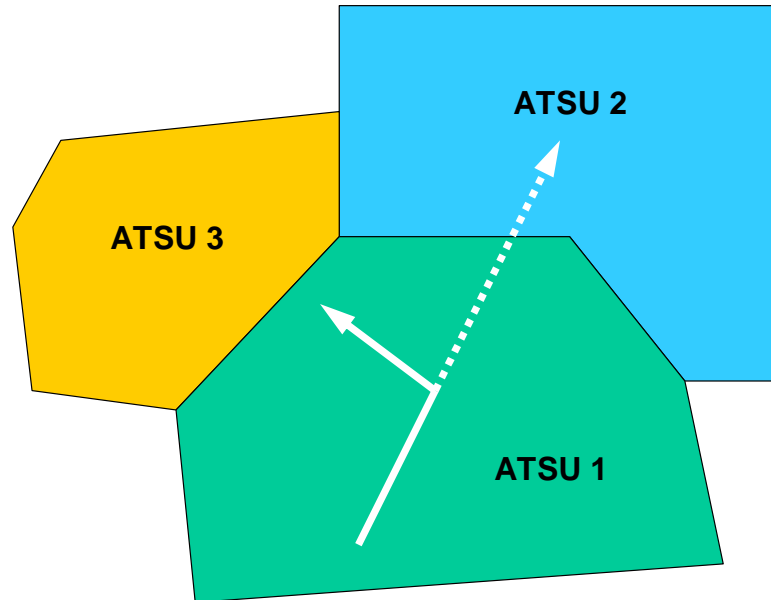

Figure 2-20. Depiction of the change in route of an aircraft

2.2.4.8.1.4 [Figure 2-21](#) shows that ATSU 1 sends a new NDA message specifying ATSU 3 as the next data authority. On receipt of this NDA message, the aircraft disconnects its CPDLC connection from ATSU 2 (if it had an inactive connection). In addition, ATSU 1 initiates address forwarding for the aircraft to ATSU 3.

2.2.4.8.1.5 In the case that ATSU 3 does not support CPDLC services, ATSU 1 requests the aircraft to terminate the CPDLC connection with ATSU 2 by:

- a) Sending a CPDLC abort request in order to terminate all connections, or
- b) Alternatively, for ATN B1 aircraft, sending a new NDA message specifying that there is now no next data authority, which will ensure that the aircraft terminates the connection with ATSU 2.

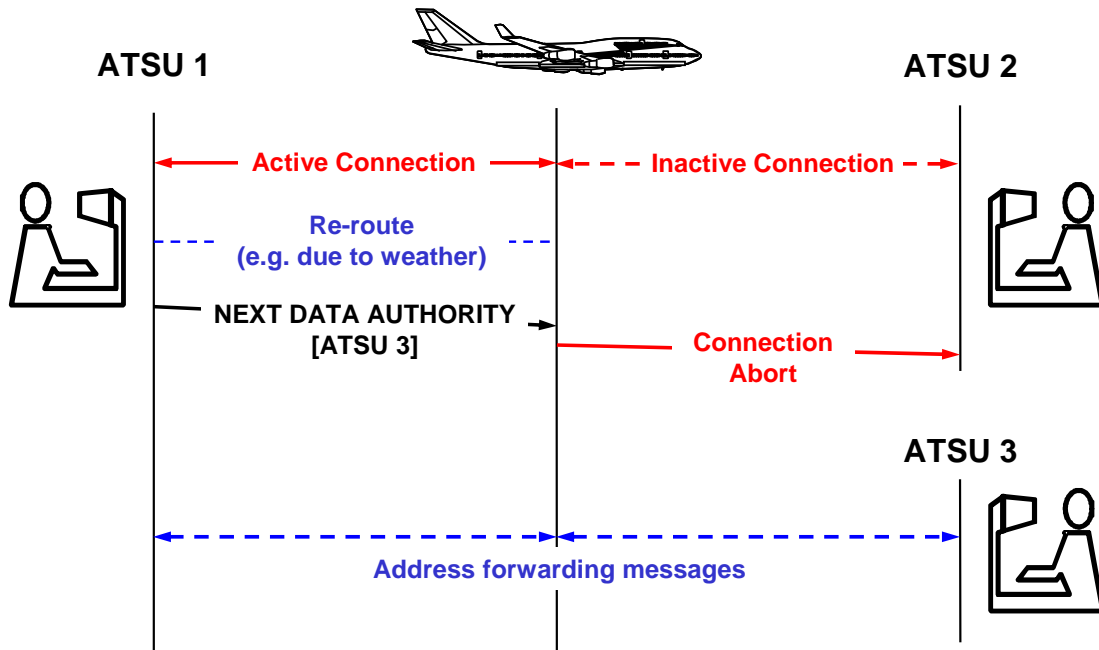

Figure 2-21. Sending a new NDA following a re-route

2.2.4.8.2 Failures of the CPDLC connection establishment

2.2.4.8.2.1 Upon receipt of a CPDLC connection request, the aircraft system sends a CPDLC connection rejection message to the next ATSU when the aircraft system receives the:

- a) CPDLC connection request message from the next ATSU before the NDA message from the CDA, as shown in [Figure 2-22](#); or
- b) NDA message designating an ATSU that is different from the ATSU sending the CPDLC connection request, as shown in [Figure 2-23](#).

Note 1.— To prevent rejection of the CPDLC connection request:

– The CDA sends the NDA message prior to initiating air-ground address forwarding to the next ATSU (Refer to [Figure 2-16](#)),

– When it is known that the ground-ground address forwarding would trigger a CPDLC connection request by next ATSU, CDA sends the NDA message prior to initiating ground-ground address forwarding to the next ATSU (Refer to [Figure 2-17](#)).

– When it is known that the next ATSU will wait for a Next Authority Notified message prior to initiating a CPDLC connection request, CDA can send the NDA message after completing ground-ground address forwarding to the next ATSU (Refer to [Figure 2-18](#)).

Note 2.— In addition to the connection rejection message, FANS 1/A aircraft will send DM 64, which provides the identity of the CDA, while ATN B1 aircraft will send [DM 107](#), which is a notification that the ATSU is not authorized to become the next data authority.

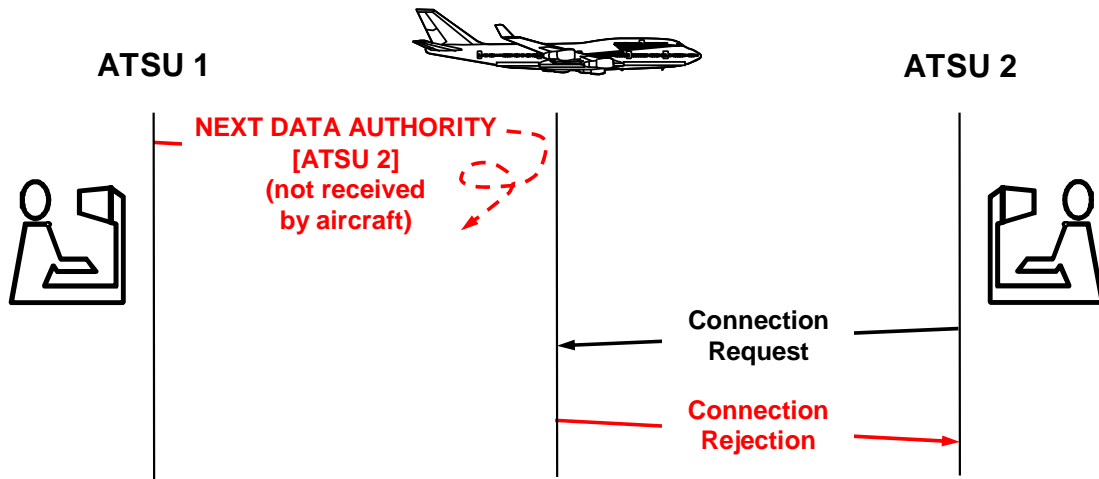

Figure 2-22. Non-receipt of the NDA message

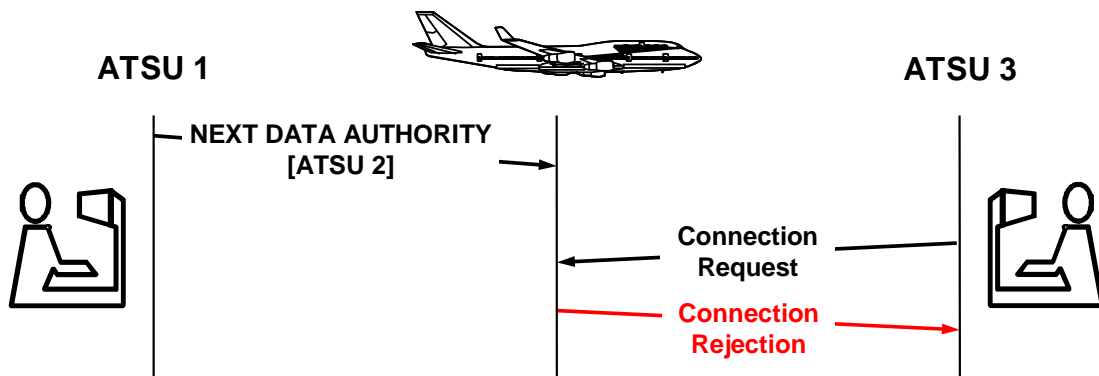

Figure 2-23. Connection request from an ATSU not designated as the NDA

2.2.4.8.2.2 The flight crew has no indication that the CPDLC connection request has been rejected.

2.2.4.8.2.3 If the controlling ATSU sends another NDA message specifying the correct ATSU to the aircraft, the next ATSU will need to send a subsequent CPDLC connection request to establish the connection, as shown in [Figure 2-24](#).

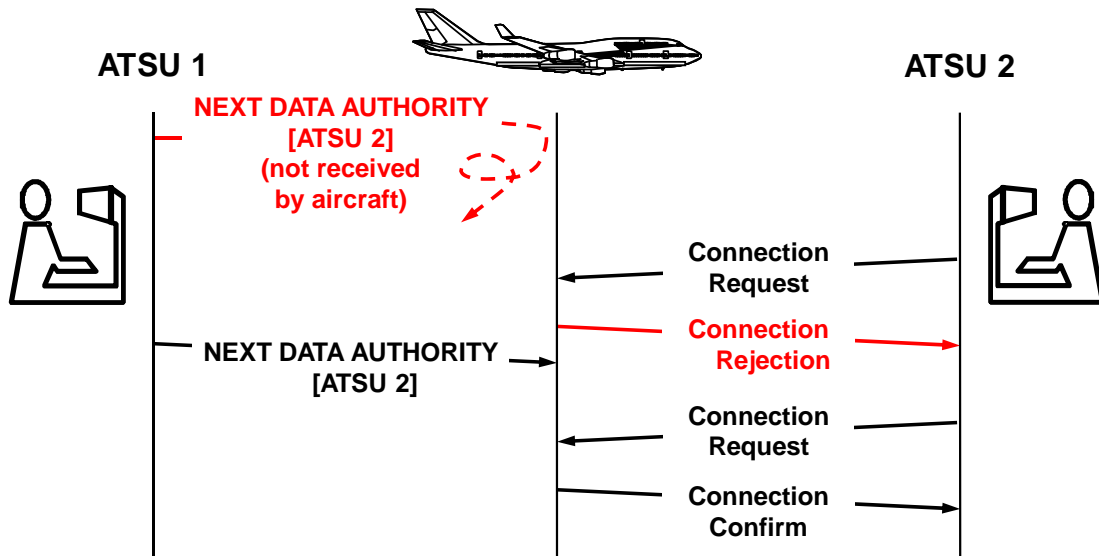

Figure 2-24. Successful CPDLC connection following a re-send of the NDA message

2.2.4.8.3 Termination of both active and inactive CPDLC connections

2.2.4.8.3.1 Normally, on receipt of a termination request message from the CDA, the aircraft system will only terminate the active CPDLC connection. However, if the termination request message element is part of a multi-element message where none of the elements require a WILCO/UNABLE (W/U) response, the aircraft system will terminate all CPDLC connections (active and inactive) by sending abort request messages, as shown in [Figure 2-25](#).

Note 1.— Some FANS 1/A aircraft will also abort all connections when open uplinks exist when the termination request message is received. Refer to [Appendix F, paragraph F.8](#) for variations in aircraft processing of open uplinks at time of transfer of communications.

Note 2.— Some ATN B1 aircraft will also abort all connections when the termination request message includes any message element other than [UM 117](#), [UM 120](#) and [UM 135](#). Refer to [Appendix F, paragraph F.8](#) for variations in aircraft processing of open uplinks at time of transfer of communications.

Note 3.— For FANS 1/A, the termination request message is normally sent as a single-element message. Refer to [paragraph 3.1.2](#) for ATC automated data link functions and [paragraph 4.2](#) for controller procedures related guidance.

Note 4.— For ATN B1, the termination request message is normally sent as a single-element message or as a multi-element message that includes [UM 117](#) or [UM 120](#) and [UM 135](#). Refer to [paragraph 3.1.2](#) for ATC automated data link functions and [paragraph 4.2](#) for controller procedures related guidance.

Note 5.— See [Appendix A](#) for message elements that require a W/U response.

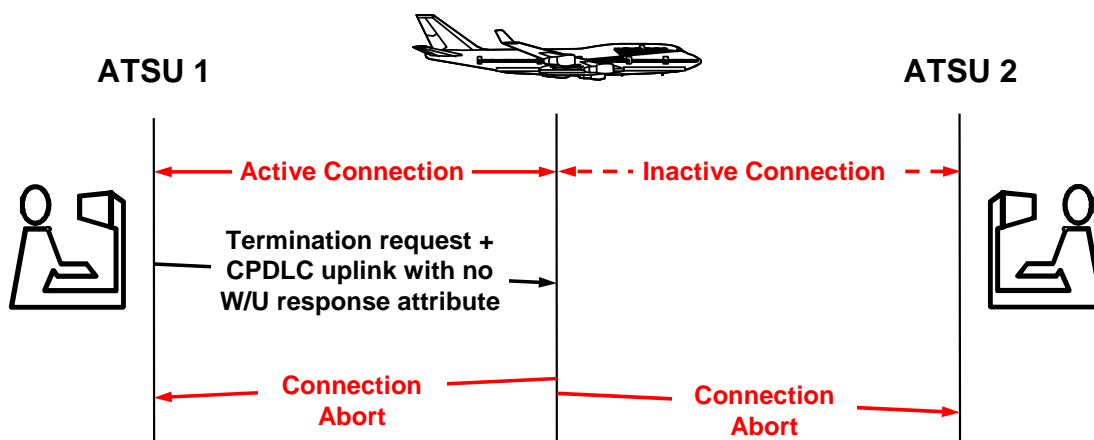

Figure 2-25. Disconnection of both active and inactive connections

2.2.5 Controller-pilot data link communications (CPDLC)

2.2.5.1 CPDLC - general

2.2.5.1.1 CPDLC is a data link application that supports the exchange of data messages directly between a controller and a flight crew.

2.2.5.1.2 When communicating with an aircraft that is operating within airspace beyond the range of DCPC VHF voice communication, CPDLC is available, and local ATC procedures do not state otherwise, the controller and flight crew would normally chose CPDLC as the means of communication. The controller and flight crew would use voice as an alternative means of communication (e.g. VHF, HF or SATVOICE direct or via a radio operator). However, in any case, the controller and flight crew will determine the communication medium that they deem to be the most appropriate at any given time.

2.2.5.1.3 In airspace where both DCPC VHF voice and CPDLC communication services are provided, and local ATC procedures do not state otherwise, the controller and flight crew will determine the communication medium to use at any given time.

Note.— ICAO Doc 4444, paragraph 8.3.2, requires that DCPC be established prior to the provision of ATS surveillance services, unless special circumstances, such as emergencies, dictate otherwise. This does not prevent the use of CPDLC for ATC communications, voice being immediately available for intervention and to address non-routine and time critical situations.

2.2.5.2 CPDLC message set

2.2.5.2.1 The CPDLC message set consists of a set of message elements, most of which correspond to a radiotelephony phraseology.

2.2.5.2.2 CPDLC message elements are referred to as:

- a) Uplinks (message elements that are sent to an aircraft); or

b) Downlinks (message elements that are sent by the aircraft).

2.2.5.2.3 Each message element has a number of attributes associated to it, including:

a) A message number that uniquely identifies each type of message element. Uplink message elements are prefixed UM and downlink message elements are prefixed with DM;

b) A response attribute that defines whether or not a response is required for a message element, and, in the case of an uplink message element, the type of response required.

Note.— Other attributes include the urgency and alert attributes to specify precedence in message presentation and indication to the recipient. However, these attributes are currently not used.

2.2.5.2.4 The CPDLC message set, including the possible responses associated with each response attribute, is included in [Appendix A](#).

2.2.5.2.5 [Table 2-9](#) provides examples of responses that may be required for a CPDLC uplink message depending on its response attribute. See [Appendix A, paragraph A.2](#) for a complete description of the responses associated with each response attribute.

Table 2-9. Examples of responses to CPDLC uplink messages

Response attribute	Description
W/U	A DM 0 WILCO or DM 1 UNABLE is required in response to this CPDLC uplink message element.
A/N	An DM 4 AFFIRM or DM 5 NEGATIVE is required in response to this CPDLC uplink message element.
R	A DM 3 ROGER or DM 1 UNABLE is required in response to this CPDLC uplink message element. <i>Note 1.</i> — FANS I/A allows only DM 3 ROGER message as a response to uplink message with a R response attribute.
Y	A response is required to close the CPDLC uplink message element. Any CPDLC downlink message satisfies the requirement. <i>Note 2.</i> — FANS I/A does not include any message element with Y response attribute.
NE (for FANS I/A) N (for ATN B1)	A response is not required to close the CPDLC uplink message element even though a response may be required operationally.

2.2.5.3 CPDLC messages

2.2.5.3.1 A CPDLC message consists of either a single message element, or a combination of up to five message elements. A CPDLC message that consists of more than one message element is a multi-element message.

Note.— As a general rule, the size of a CPDLC message needs to be kept to a minimum. Refer to [paragraphs 4.3.6, 4.4.4, 5.3.1.2 and 5.4.1.4](#) for guidelines on use of multi-element messages.

2.2.5.4 Responses to CPDLC messages

2.2.5.4.1 A CPDLC message may be a multi-element message containing a number of message elements that have different response types. However, the flight crew or controller can only provide a single response, based on the highest precedence of the response type for the message elements in the message. [Table 2-10](#) lists the response types in order of decreasing precedence for CPDLC uplink and downlink messages.

2.2.5.4.2 When a multi-element message contains at least one message element with a Y response type, the flight crew or controller responds with a single message element response associated with the highest precedence response type for the elements in the message (as per [Table 2-10](#)), and additionally the message element(s) associated with the message element(s) with a Y response type.

Note.— *Some aircraft send all elements in a multi-element response message, others send the initial response associated with the highest precedence response type for the elements in the message first, and then send the message element(s) associated with the message element(s) with a Y response type.*

Table 2-10. Precedence of responses

CPDLC uplink messages	
Response type	Precedence
W/U	1
A/N	2
R	3
Y (for ATN B1) NE (for FANS 1/A)	4
N (for ATN B1)	5
CPDLC downlink messages	
Response type	Precedence
Y	1
N	2

2.2.5.4.3 [Table 2-11](#) provides examples of the appropriate responses to various multi-element CPDLC uplink messages.

Table 2-11. Examples of multi-element CPDLC uplink messages

Multi-element message	(Individual) response required for each message element	Response required for entire message
UM 20 CLIMB TO FL370 or <i>CLIMB TO AND MAINTAIN FL370</i> UM 129 REPORT MAINTAINING FL370 or <i>REPORT LEVEL FL370</i>	W/U W/U or R	W/U
UM 20 CLIMB TO FL370 or <i>CLIMB TO AND MAINTAIN FL370</i> UM 107 MAINTAIN PRESENT SPEED	W/U W/U	W/U
UM 147 REQUEST POSITION REPORT UM 169 ADS-C HAS FAILED	Y or NE R	R and additionally DM 48 POSITION REPORT [position report] (appended to R response message or as separate message)
UM 150 CAN YOU ACCEPT FL370 AT 2200 UM 87 EXPECT DIRECT TO MINNY	A/N R	A/N
UM 190 FLY HEADING 350 UM 231 STATE PREFERRED LEVEL	W/U Y	W/U and additionally DM 106 PREFERRED LEVEL [level] or FL[altitude] (appended to W/U response message or as separate message)

2.2.5.5 Open and closed CPDLC messages

2.2.5.5.1 A CPDLC message is open if the aircraft or ground system has not yet received a required response.

2.2.5.5.2 A CPDLC message is closed if the aircraft or ground system either:

- a) Does not require a response; or
- b) Has already received a required response.

*Note 1.— **UM 1** STANDBY and **UM 2** REQUEST DEFERRED responses do not close a downlink CPDLC message.*

*Note 2.— **DM 2** STANDBY response does not close an uplink CPDLC message.*

2.2.5.6 CPDLC dialogues

2.2.5.6.1 Messages that are related (e.g. a CPDLC downlink request, the corresponding CPDLC uplink clearance and the subsequent pilot response) constitute a CPDLC dialogue.

- a) A CPDLC dialogue is open if any of the CPDLC messages in the dialogue are open;
- b) A CPDLC dialogue is closed if all CPDLC messages in the dialogue are closed.

Note.— A dialogue can be technically closed, but still be operationally open. For example, when a **DM 0 WILCO** has been sent for a **UM 129 REPORT MAINTAINING [level]**, the dialogue is technically closed, but not operationally closed until the ATSU receives the **DM 37 MAINTAINING [level]**.

2.2.5.6.2 **Figure 2-26** provides an example of the individual message and dialogue status for a CPDLC request and clearance exchange.

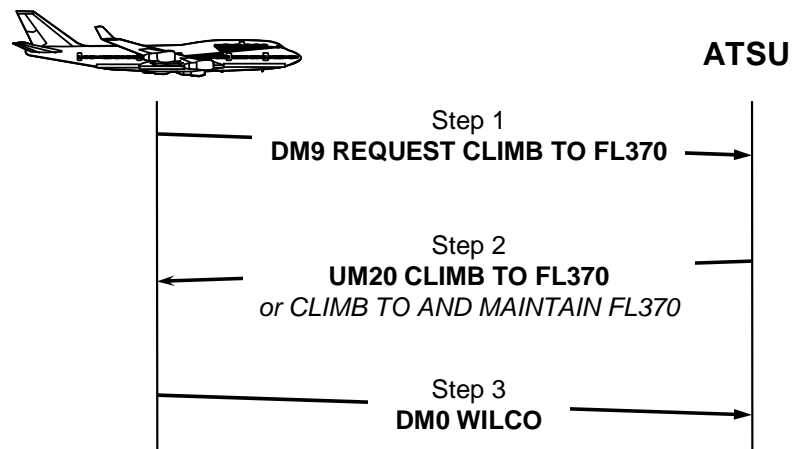

Step	CPDLC Message	Response Attribute	UM Status	DM Status	Dialogue Status
1	Downlink request	Y	N/A	Open	Open
2	Uplink response	W/U	Open	Closed	Open
3	Downlink response	N	Closed	Closed	Closed

Figure 2-26. Message/dialogue status for CPDLC request and clearance exchange

2.2.5.6.3 **Figure 2-27** provides an example of the individual messages and dialogue status for a CPDLC confirmation request and report exchange.

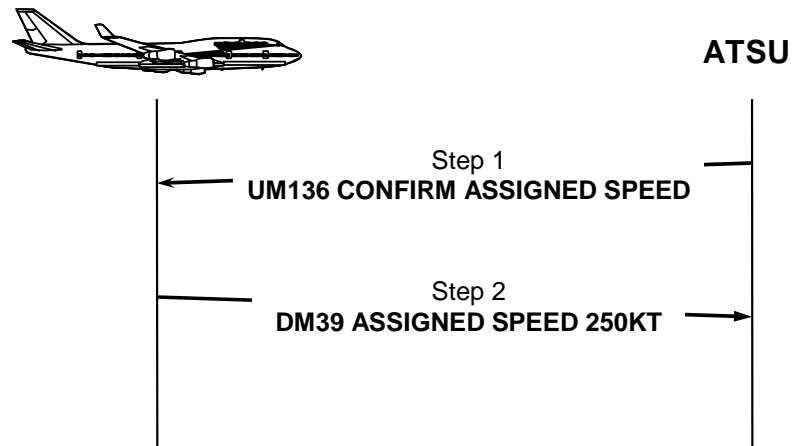

Step	CPDLC Message	Response Attribute	UM Status	DM Status	Dialogue Status
1	Uplink request	Y or NE	Open or Closed	N/A	Open or Closed
2	Downlink response	N	Closed	Closed	Closed

Figure 2-27. Message/dialogue status for CPDLC confirmation request and report exchange

2.2.5.7 Message identification numbers (MIN)

2.2.5.7.1 For each CPDLC connection, the aircraft and ground systems assign every CPDLC uplink and downlink message an identifier, known as a message identification number (MIN). The MIN is an integer in the range 0 to 63 (inclusive). The ground system assigns the MIN for uplink messages, and the aircraft system assigns the MIN for downlink messages.

Note.— Some aircraft and ground systems assign MINs sequentially through the allowed range, while others re-assign MINs as soon as the dialogues using them have been closed. The numbers used as MINs by the ground and aircraft systems are entirely independent.

2.2.5.8 Message reference numbers (MRN)

2.2.5.8.1 The aircraft and ground systems assign a message reference number (MRN) to a CPDLC message when it is a response to another CPDLC message. The MRN of the response message is the same as the MIN of the corresponding CPDLC message in the dialogue.

2.2.5.8.2 The aircraft and ground systems associate corresponding CPDLC messages within a dialogue by their message identification numbers and message reference numbers.

2.2.5.8.3 This functionality ensures that the aircraft and ground systems associate a CPDLC response message with the correct CPDLC message in the dialogue.

2.2.5.8.4 **Table 2-12** provides an example of a CPDLC dialogue to illustrate the way in which the aircraft and ground systems track the CPDLC messages using the MIN and MRN. In this example, the last MIN assigned by the aircraft system was 7 and by the ground system was 11.

Table 2-12. Example of CPDLC dialogue

CPDLC message	MIN	MRN	Comment
DM 6 REQUEST FL350	8		The aircraft system assigns a MIN of 8 to this message. The downlink request is open.
UM 1 STANDBY	12	8	The ground system assigns a MIN of 12 to this uplink. Because this uplink is a response to the downlink, the ground system assigns the MRN equal to the MIN of the downlink request (i.e. MRN = 8). UM 1 STANDBY is not a closure message. The status of the downlink request is open.
UM 20 CLIMB TO FL350 or <i>CLIMB TO AND MAINTAIN FL350</i> UM 129 REPORT MAINTAINING [level] or <i>REPORT LEVEL FL350</i>	13	8	The ground system assigns a MIN of 13 to this uplink (i.e. the ground system increments the MIN of the previous uplink message by one). Because this uplink is a response to the downlink, the ground system assigns the MRN equal to the MIN of the downlink request (i.e. MRN = 8).
DM 0 WILCO	9	13	The aircraft system assigns a MIN of 9 to this downlink (i.e. the aircraft system increments the MIN of the previous downlink message by one). Because this downlink is a response to the uplink, the aircraft system assigns the MRN equal to the MIN of the uplink (i.e. MRN = 13). DM 0 WILCO is a closure message. The status of the uplink message is closed.
DM 37 MAINTAINING FL350 or <i>LEVEL FL350</i>	10		The aircraft system assigns a MIN of 10 to this downlink (i.e. the aircraft system increments the MIN of the previous downlink message by one). The aircraft system does not assign an MRN because the associated uplink message has already been closed with the WILCO response. The ground system does not respond to this downlink message because it does not require a response.

2.2.6 Automatic dependent surveillance – contract (ADS-C)

2.2.6.1 ADS-C – general

2.2.6.2 ADS-C uses various systems on board the aircraft to automatically provide aircraft position, altitude, speed, intent and meteorological data, which can be sent in a report to an ATSU or AOC facility ground system for surveillance and route conformance monitoring.

2.2.6.2.1 One or more reports are generated in response to an ADS contract, which is requested by the ground system. An ADS contract identifies the types of information and the conditions under which reports are to be sent by the aircraft. Some types of information are included in every report, while other types are provided only if specified in the ADS contract request. The aircraft can also send unsolicited ADS-C emergency reports to any ATSU that has an ADS contract with the aircraft.

2.2.6.2.2 An ATSU system may request multiple simultaneous ADS contracts to a single aircraft, including one periodic and one event contract, which may be supplemented by any number of demand contracts. Up to five separate ground systems may request ADS contracts with a single aircraft.

Note.— Although the terms are similar, ADS-C and ADS-B are two different applications. In comparison, ADS-B (PSR, SSR or any comparable ground-based system that enables the identification of aircraft) is an ATS surveillance system. An ADS-B-capable aircraft supports ATS surveillance services and broadcasts information at a relatively high rate, and any appropriate receiver on the ground or in another aircraft within range can receive the information.

2.2.6.3 ADS contract

2.2.6.3.1 After receiving a logon request, the ATSU will need to establish ADS contract(s) with the aircraft before it can receive any ADS-C reports. There are three types of ADS contracts:

- a) Periodic contract;
- b) Demand contract; and
- c) Event contract.

2.2.6.3.2 The ground system can establish ADS contracts without flight crew action provided that ADS-C in the aircraft system is not selected off. The flight crew has the ability to cancel all contracts by selecting ADS-C off and some aircraft systems allow the flight crew to cancel an ADS contract with a specific ATSU.

Note.— The ADS-C capability on the aircraft is normally not turned off per [paragraph 5.5.1](#). ADS contracts are managed by ATSUs based on their surveillance requirements (refer to [paragraph 4.5.2](#)).

2.2.6.3.3 Periodic contract

2.2.6.3.3.1 A periodic contract allows an ATSU to specify:

- a) The time interval at which the aircraft system sends an ADS-C report; and
- b) The optional ADS-C groups that are to be included in the periodic report. Each optional group may have a unique modulus which defines how often the optional group is included with the periodic report (e.g. a modulus of five indicates that the optional group would be included with every fifth periodic report sent).

2.2.6.3.3.2 The range and resolution of the time interval parameter in the periodic contract allows for an interval to be specified between 1 second and 4,096 seconds (approximately 68 minutes). However, RTCA DO-258A/EUROCAE ED-100A limits the minimum interval to 64 seconds. If the ground system specifies a time interval less than 64 seconds, the aircraft system will respond with a non-compliance notification and establish a periodic contract with a 64-second reporting interval. If the ground system does not specify a time interval, the aircraft will establish a periodic contract of 64 seconds for emergency periodic reporting and 304 seconds for normal periodic reporting.

2.2.6.3.3.3 The ground system may permit the controller to alter the periodic reporting interval to allow for situations where the controller desires a longer or shorter reporting interval. The controller may select a shorter reporting interval to obtain more frequent surveillance information, for example, during an off-route deviation or an emergency.

Note.— The ANSP ensures that separation minima are applied in accordance with appropriate standards. The ground system may prevent the controller from selecting a periodic reporting interval that is longer than the maximum interval specified in the standard for the separation minima being applied.

2.2.6.3.3.4 An ATSU can establish only one periodic contract with an aircraft at any one time. A number of ATSUs can each establish their own periodic contract and specify their own conditions for the report with the same aircraft at the same time.

2.2.6.3.3.5 A periodic contract remains in place until it is either cancelled or modified. Whenever an ATSU establishes a new periodic contract, the aircraft system automatically replaces the previous periodic contract with the new one.

2.2.6.3.3.6 As shown in [Figure 2-28](#), in response to a new ADS-C periodic contract, the aircraft:

- a) Sends an acknowledgement; and
- b) Sends the first periodic report of the new contract.

Note.— The contract acknowledgement and first ADS-C report may be transmitted in a single downlink message.

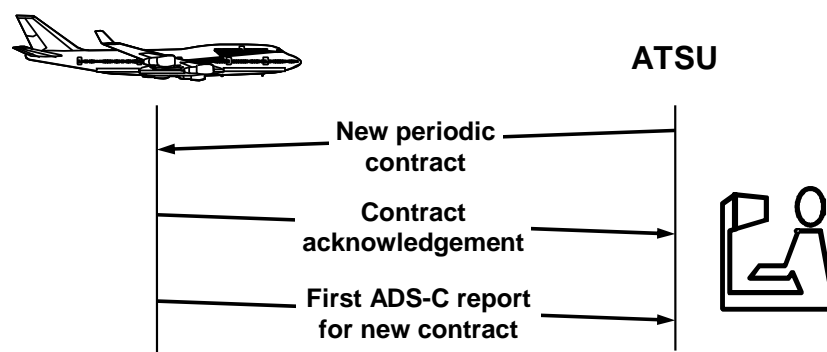

Figure 2-28. ADS-C periodic contract sequence

2.2.6.3.4 Demand contract

2.2.6.3.4.1 A demand contract allows an ATSU to request a single ADS-C periodic report. A demand contract does not cancel or modify any other ADS contracts that may be in effect with the aircraft.

2.2.6.3.5 ADS-C emergency reports

2.2.6.3.5.1 The ADS-C application also supports emergency alerting. An ADS-C emergency report is a periodic report that is tagged as an “emergency” report, allowing the emergency situation to be highlighted to ATC.

2.2.6.3.5.2 An ADS-C emergency can be triggered by the flight crew in a number of ways:

- a) Manually, by selecting the ADS-C emergency function;
- b) Indirectly, by triggering another type of emergency alerting system (e.g. transmission of a CPDLC position report or selection of an SSR emergency code); and
- c) Covertly.

Note.— *The availability of the above functionality may vary between aircraft types.*

2.2.6.3.5.3 There have been reported instances of inadvertent ADS-C emergencies being transmitted. To check for inadvertent or covert activation of the ADS-C emergency function, refer to [paragraph 4.8.3.3](#).

2.2.6.3.5.4 Once an ADS-C emergency has been triggered, under normal circumstances the avionics will continue to transmit ADS-C emergency periodic reports until the flight crew de-selects the ADS-C emergency function.

2.2.6.3.5.5 When this occurs, a “cancel ADS-C emergency” report is transmitted with the next ADS-C periodic report. Depending on the current ADS-C periodic reporting interval, this may be 20-30 minutes after the flight crew has actually cancelled the emergency, as shown in [Figure 2-29](#).

2.2.6.3.5.6 To reduce the time interval between the flight crew cancelling the ADS-C emergency and the transmission of the “cancel ADS-C emergency” report, a recommended practice is to reduce the ADS-C reporting interval (refer to [paragraph 4.8.2.5](#)). This also provides enhanced situational awareness for an aircraft that is potentially in an emergency situation. Refer [paragraph 4.5.4](#).

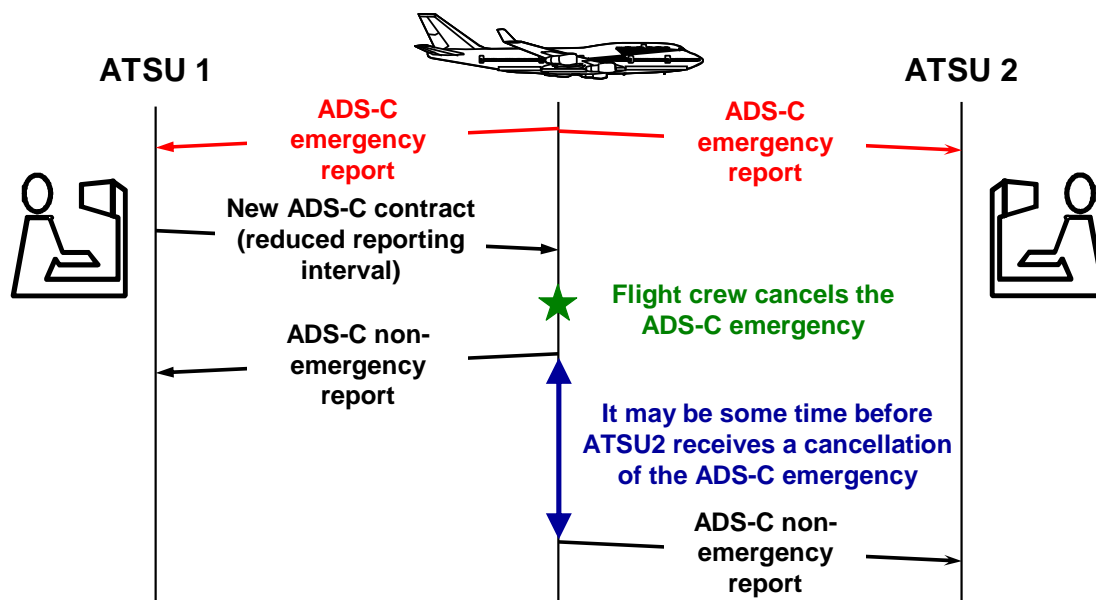

Figure 2-29. ADS-C emergency and non-emergency report sequence

2.2.6.3.6 Event contract

2.2.6.3.6.1 An event contract allows an ATSU to request an ADS-C report whenever a specific event occurs. An ATSU can establish only one event contract with an aircraft at any one time. However, the event contract can contain multiple event types. These types of optional events include:

- Waypoint change event (WCE);
- Level range deviation event (LRDE);
- Lateral deviation event (LDE); and
- Vertical rate change event (VRE).

2.2.6.3.6.2 As shown in [Figure 2-30](#), in response to a new ADS-C event contract, the aircraft separately sends an acknowledgement and then an ADS-C report(s) is transmitted only after one of the specified events occurs.

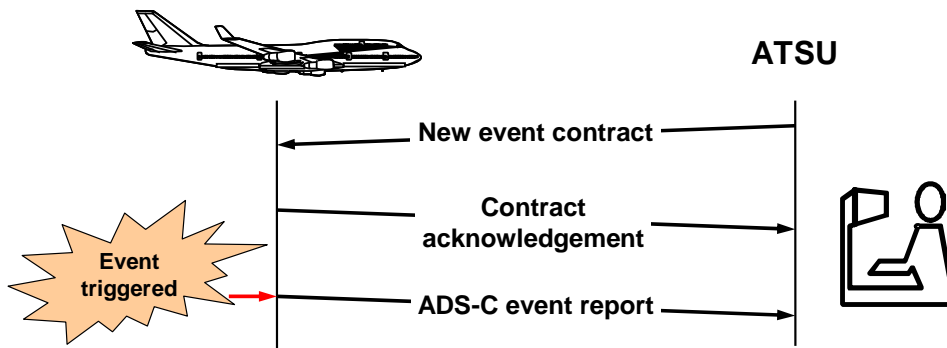

Figure 2-30. ADS-C event contract sequence

2.2.6.3.6.3 An event contract remains in effect until the ATSU cancels it or until the event(s) used to trigger the report occurs. The waypoint change event contract will trigger a report for all waypoint changes. All other event contracts will trigger a report on the first occurrence and then, if necessary, the ATSU will need to request a new event contract indicating all desired event types.

2.2.6.3.6.4 Waypoint change event (WCE)

2.2.6.3.6.4.1 The aircraft system sends a WCE report when a change occurs to the Next and/or Next + 1 waypoint (due to a flight plan change or waypoint sequence) in the FMS.

2.2.6.3.6.4.2 As shown in [Figure 2-31](#), when the aircraft sequences MICKY, the Next and Next + 1 waypoints contained in the FMS change. This results in sending a WCE report to all ATSUs that have an event contract containing a WCE with this aircraft.

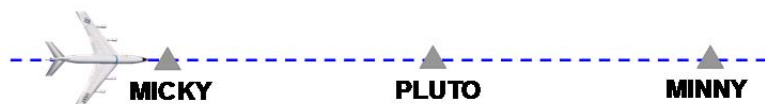

	Next	Next + 1
Before sequencing MICKY	MICKY	PLUTO
After sequencing MICKY	PLUTO	MINNY

Figure 2-31. ADS-C waypoint change event

2.2.6.3.6.4.3 Other events that may cause the aircraft system to send a WCE report include:

- a) The flight crew executing a clearance direct to a waypoint (i.e. next waypoint is changed);

b) The flight crew inserting a waypoint ahead of the aircraft (resulting in a change to the Next or Next + 1 waypoint); and

c) The flight crew executing a lateral offset (resulting in a change to the Next waypoint).

2.2.6.3.6.4.4 A waypoint change event report contains the following ADS-C groups:

a) Basic group; and

b) Predicted route group.

2.2.6.3.6.5 Level range deviation event (LRDE)

2.2.6.3.6.5.1 The ATSU specifies the LRDE by defining the lower and upper limits of the level range.

2.2.6.3.6.5.2 For example, in [Figure 2-32](#), the LRDE has been defined with a lower limit of FL368 and an upper limit of FL372.

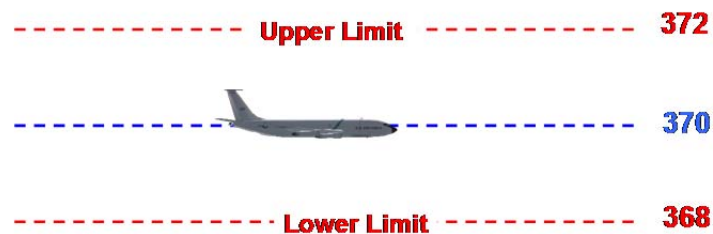

Figure 2-32. ADS-C level range deviation event

2.2.6.3.6.5.3 The aircraft system sends a LRDE report when the aircraft's flight level is outside the level range tolerances defined in the ADS-C event contract ([Figure 2-33](#)).

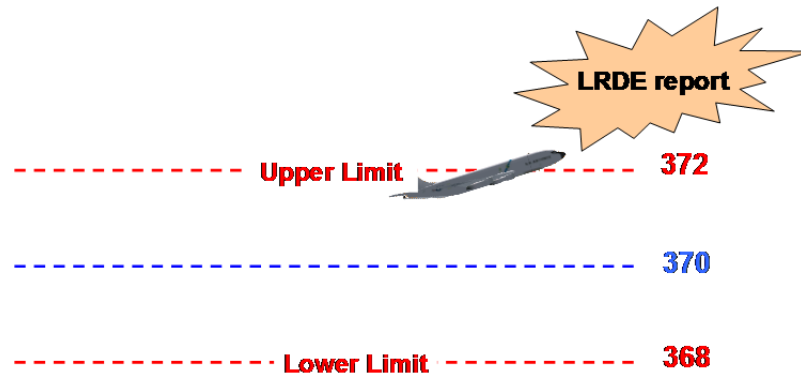

Figure 2-33. ADS-C level range deviation event report

2.2.6.3.6.5.4 Once an aircraft sends an LRDE report, it will not send another LRDE report until the ATSU establishes a new ADS-C LRDE contract.

2.2.6.3.6.5.5 An LRDE report contains the ADS-C basic group only.

2.2.6.3.6.6 Lateral deviation event

2.2.6.3.6.6.1 The ATSU specifies the lateral deviation event by defining a lateral deviation threshold, which is a maximum off-route distance either side of the route as specified by the ATSU. It is not possible to define different distances on each side of the route.

2.2.6.3.6.6.2 For example, in [Figure 2-34](#), the lateral deviation event has been defined to be triggered for a lateral deviation threshold of greater than 5NM either side of the route.

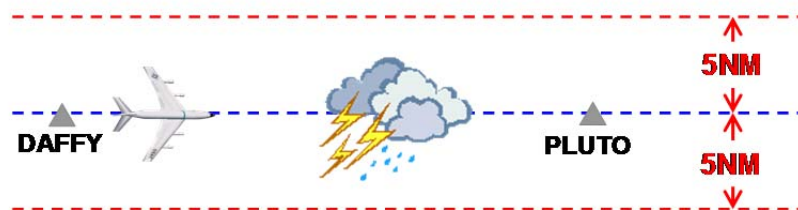

Figure 2-34. ADS-C lateral deviation event

2.2.6.3.6.6.3 The lateral deviation event is triggered when the lateral distance between the aircraft's actual position and its expected position, as defined in the aircraft active flight plan, exceeds the lateral deviation threshold defined in the ADS-C event contract ([Figure 2-35](#)).

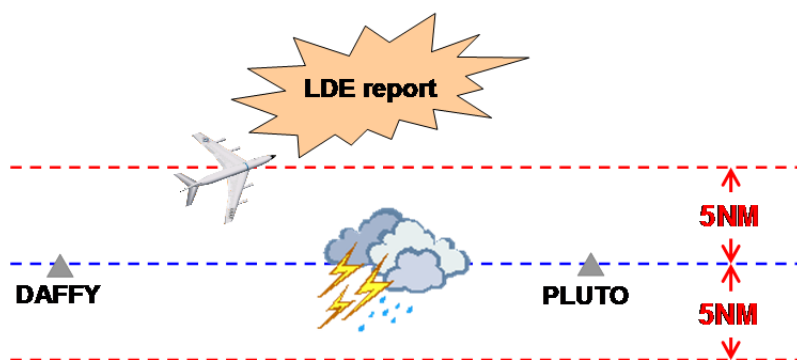

Figure 2-35. ADS-C lateral deviation event report

2.2.6.3.6.6.4 Under certain circumstances, such as when the flight crew activates an offset that is greater than the lateral deviation threshold, the aircraft may transmit a lateral deviation event report immediately while still on the cleared route. This should be interpreted as an early warning of an impending lateral deviation.

2.2.6.3.6.6.5 As shown in [Figure 2-36](#), after the offset has been activated, the aircraft system compares the current position of the aircraft ① (on route) with the expected position of the aircraft on the offset route ②, and concludes that it is off route by the intervening distance. If this off-route distance exceeds the lateral deviation threshold, the aircraft will transmit a lateral deviation event report, containing the current position of the aircraft ①.

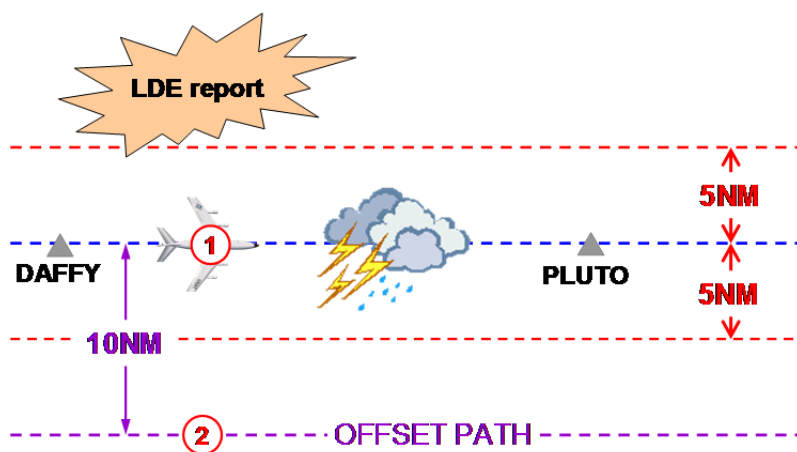

Figure 2-36. Effect of offset on ADS-C lateral deviation event report

2.2.6.3.6.6.6 As shown in [Figure 2-37](#), LDE reports are based on deviations from the aircraft active flight plan. If the aircraft active flight plan is different to the flight plan held by the ATSU, and the aircraft

remains within the lateral deviation threshold (as defined by the ADS contract) of the aircraft active flight plan, no lateral deviation event report will be triggered.

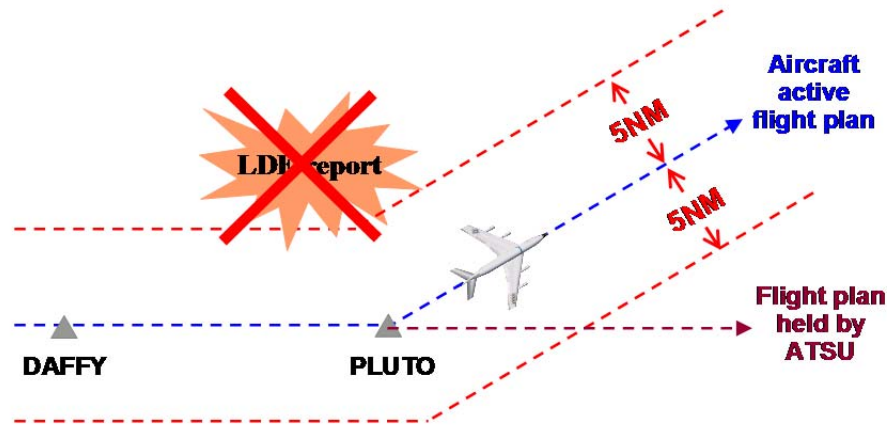

Figure 2-37. No lateral deviation event report if active route is different to route held by ATSU

2.2.6.3.6.6.7 Once an aircraft has downlinked a lateral deviation event report, no further deviations will trigger another report until the ATSU re-establishes an ADS-C event contract containing a lateral deviation event.

2.2.6.3.6.6.8 A lateral deviation event report contains the ADS-C basic group only.

2.2.6.3.6.7 Vertical rate change event (VRE)

2.2.6.3.6.7.1 The vertical rate change event is triggered in one of two ways:

- a) Positive vertical rate: aircraft's rate of climb is greater than the vertical rate threshold; or
- b) Negative vertical rate: aircraft's rate of descent is greater than the vertical rate threshold.

Note.— The vertical rate change event does not detect a reduction in either the climb or descent rate.

2.2.6.3.6.7.2 A vertical rate change event report contains the following ADS-C groups:

- a) Basic group; and
- b) Earth reference group.

2.2.6.3.7 Cancelling ADS contracts

2.2.6.3.7.1 Cancelling ADS contracts assists in:

- a) Minimizing costs associated with unnecessary ADS-C reports;
- b) Reducing congestion in the communication network; and

c) Ensuring that subsequent ATSU's can establish ADS contracts with the aircraft (there is a limit to the number of ADS-C connections that an aircraft can support).

2.2.6.3.7.2 The ATSU cancels an ADS contract and terminates the ADS-C connection when it no longer needs ADS-C reports to avoid unnecessary loading of the data link system. The ground system terminates the ADS-C connection when:

- a) The aircraft has crossed the boundary and the transferring ATSU needs no further surveillance information from the flight;
- b) The ATSU has cancelled or finished the flight plan for the aircraft; or
- c) The controlling authority or an adjacent ATSU needs no further surveillance information from the flight.

2.2.6.3.7.3 The flight crew is able to terminate ADS-C connections, which in turn cancels ADS contracts. This capability is used in accordance with guidelines provided in [paragraph 5.5](#).

2.2.6.4 ADS-C report

2.2.6.4.1 The aircraft system sends specific aircraft data in different groups of an ADS-C report. Each group contains different types of data. An ADS-C event report contains only some of the groups, which are fixed. The ADS-C periodic report can contain any of the ADS-C groups, which the ATSU specifies in the contract request.

2.2.6.4.2 ADS-C groups include:

- a) Basic group ([Figure 2-38](#));
- b) Flight identification group ([Figure 2-39](#));
- c) Earth reference group ([Figure 2-40](#));
- d) Air reference group ([Figure 2-41](#));
- e) Airframe identification group ([Figure 2-42](#));
- f) Meteorological group ([Figure 2-43](#));
- g) Predicted route group ([Figure 2-44](#));
- h) Fixed projected intent group ([Figure 2-45](#)); and
- i) Intermediate projected intent group ([Figure 2-46](#)).

2.2.6.4.3 At a minimum, all ADS-C reports contain the basic group.

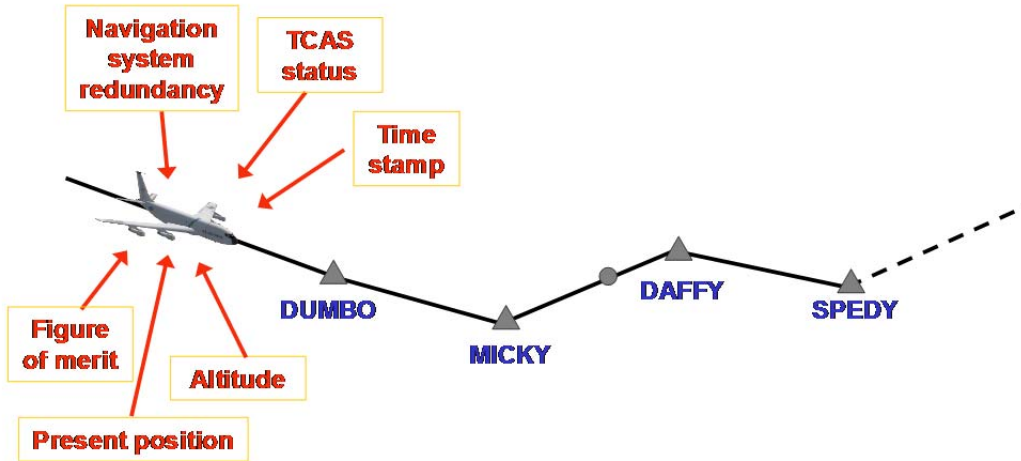

Figure 2-38. ADS-C basic group

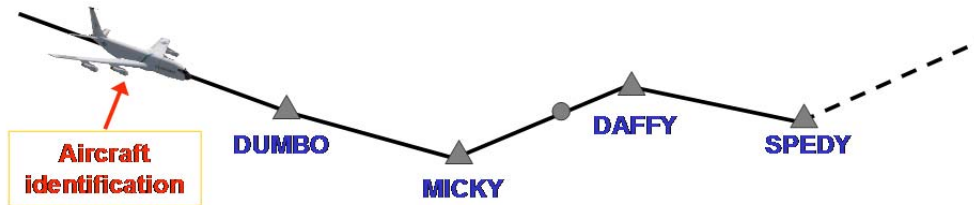

Figure 2-39. ADS-C flight identification group

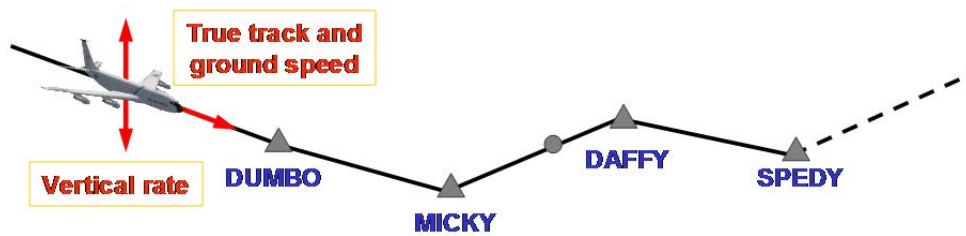

Figure 2-40. ADS-C Earth reference group

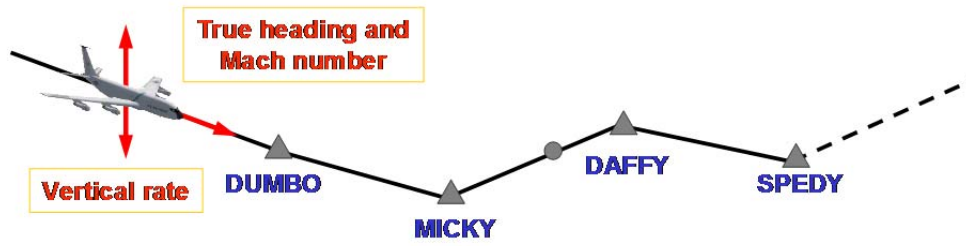

Figure 2-41. ADS-C air reference group

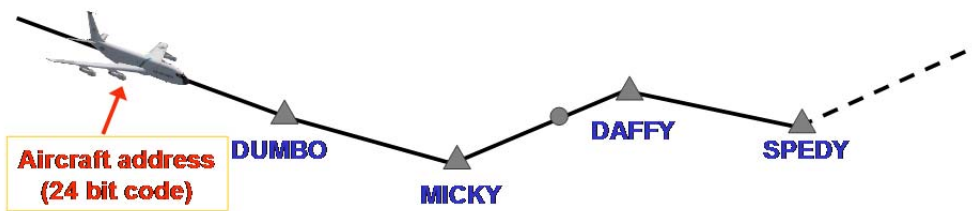

Figure 2-42. ADS-C airframe identification group

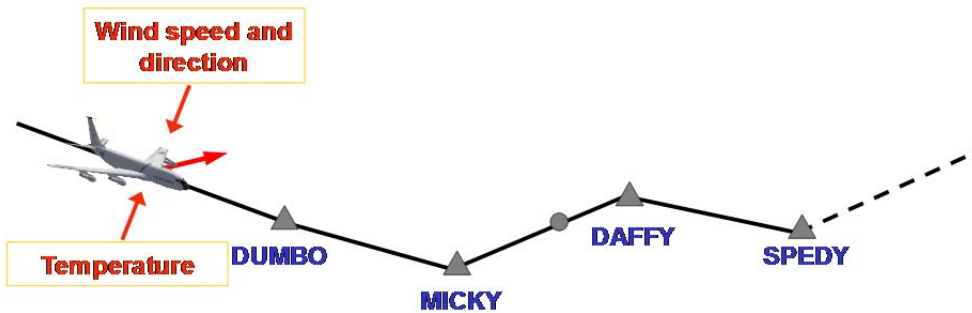

Figure 2-43. ADS-C meteorological group

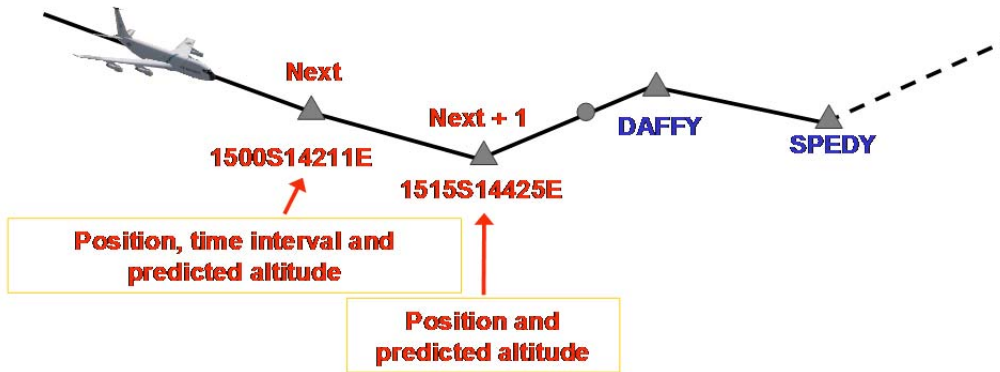

Figure 2-44. ADS-C predicted route group

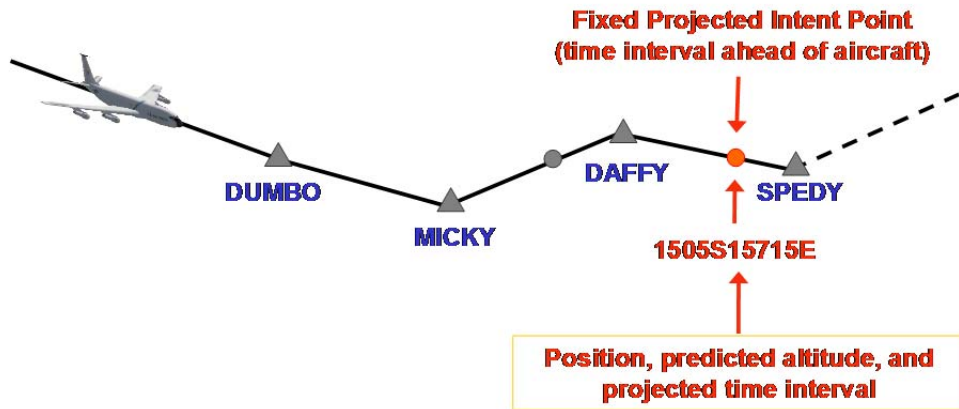

Figure 2-45. ADS-C fixed projected intent group

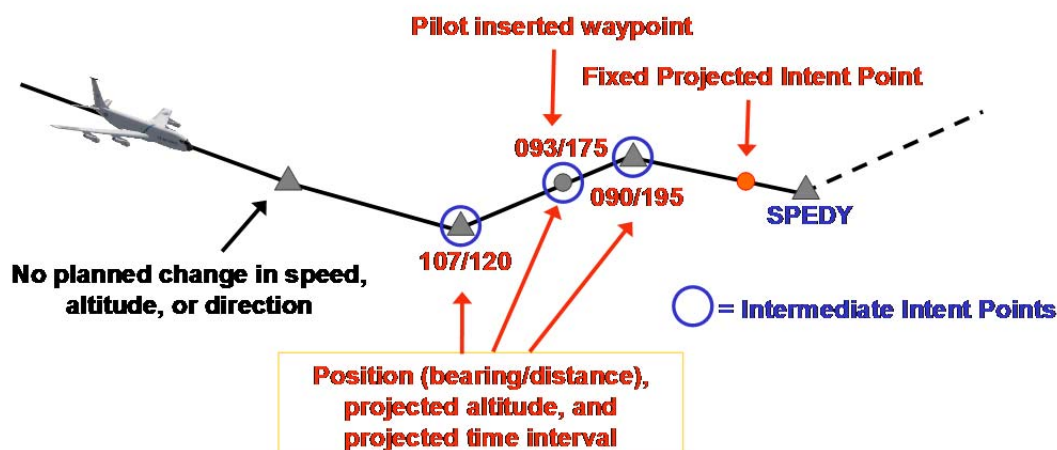

Figure 2-46. ADS-C intermediate projected intent group

2.2.6.5 Contents of ADS-C groups

2.2.6.5.1 The contents of the various ADS-C groups are depicted in the figures identified in [paragraph 2.2.6.4.2](#).

Note 1.— Up to 10 points can be included in the intermediate projected intent group. For a point to qualify to be included in the intermediate projected intent group, the point needs to be:

- a) between the current position and the fixed projected point; and
- b) associated with a planned speed, altitude or route change.

Note 2.— The intermediate projected intent group may include a FMS generated point, for example, the top of descent (TOD) point (planned altitude change), which does not correspond to any waypoint in the flight plan.

2.2.6.5.2 The aircraft system defines the:

- a) Present position (in the basic group) and Next and Next + 1 information (in the predicted route group and fixed projected intent group) as latitude/longitude; and
- b) Positional information (in the intermediate projected intent group) as a bearing/distance from the present position in the basic group.

Note.— Positional information in an ADS-C report does not contain the name(s) of waypoints.

2.2.6.5.3 The time stamp is expressed in seconds past the last hour

2.2.6.5.4 Estimates are expressed as estimated time intervals (in seconds) from the time stamp at the present position in the basic group.

2.2.6.6 Using ADS-C reports

2.2.6.6.1 The ATSU may use an ADS-C report for a variety of purposes. These include:

- a) Establishing and monitoring of traditional time-based separation minima;
- b) Establishing and monitoring of distance-based separation standards;
- c) Flagging waypoints as ‘overflown’;
- d) Updating estimates for downstream waypoints;
- e) Route and level conformance monitoring;
- f) Updating the display of the ADS-C position symbol, and the associated extrapolation;
- g) Generating (and clearing) alerts;
- h) Generating (and clearing) ADS-C emergencies;
- i) Updating meteorological information; and
- j) Updating other information in the flight plan held by the ATSU.

2.2.6.6.2 Predicted route conformance

2.2.6.6.2.1 The ATSU may use information from the basic group, the intermediate projected intent group, the fixed projected intent group and the predicted route group for route conformance monitoring.

2.2.6.6.2.2 The ATSU can compare information from the predicted route group, the fixed projected intent group or intermediate projected intent group against the expected route in the flight plan to provide an indication to the controller when a discrepancy exists.

Note.— To prevent nuisance indications, route conformance monitoring may include tolerances, consistent with safety criteria, when comparing the reported data against the expected route (e.g. to accommodate 1 or 2 nm strategic lateral offset procedures).

2.2.6.6.2.3 A ground system supporting ATS or AOC can specify periodic and event contracts differently from other ground systems, such as:

- a) Different ADS-C groups as shown in [Figure 2-47](#);
- b) Different periodic reporting interval as shown in [Figure 2-48](#); and
- c) Different types of event contracts as shown in [Figure 2-49](#).

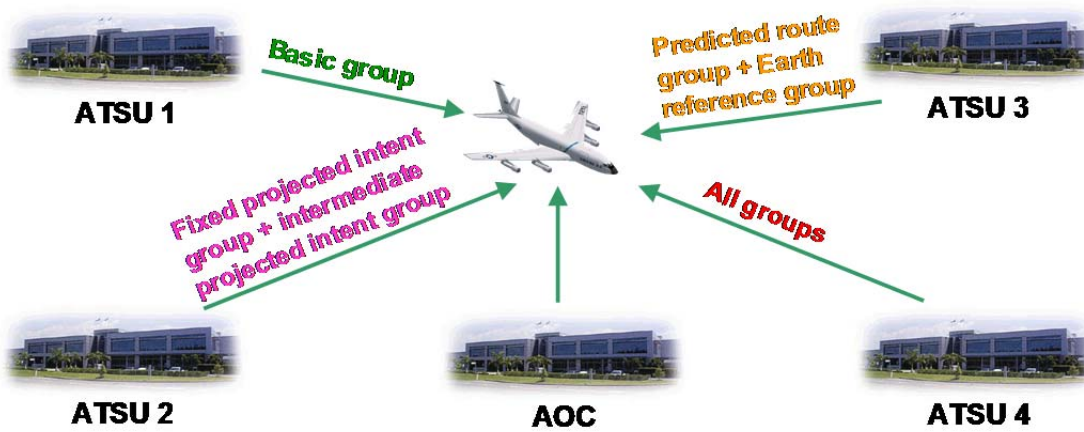

Figure 2-47. Multiple ADS periodic contracts with different groups



Figure 2-48. Multiple ADS periodic contracts with different reporting intervals

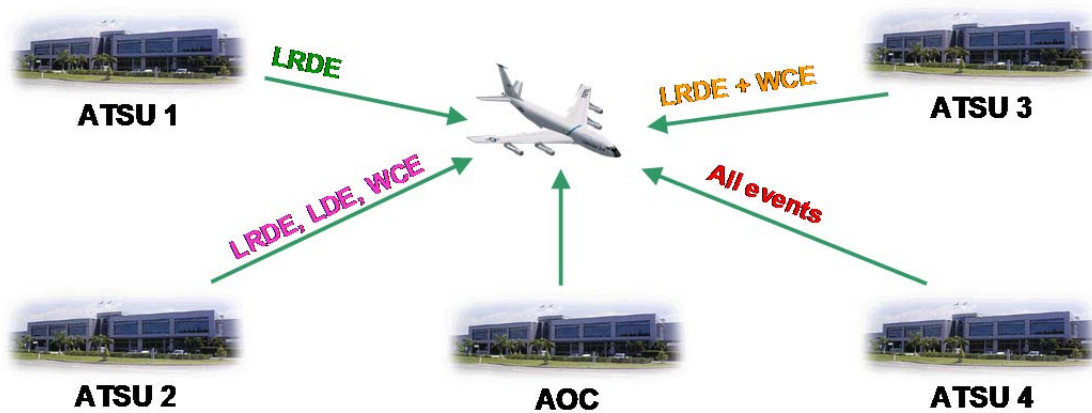

Figure 2-49. Multiple and different ADS event contracts

2.2.6.6.3 Level conformance

2.2.6.6.3.1 The ATSU may use level range deviation events (LRDE) to monitor an aircraft conformance with cleared level.

2.2.6.6.4 Generating emergency alerts

2.2.6.6.4.1 The ATSU may use the vertical rate change event (VRE) to assist in the provision of Alerting service. The VRE can be used in this context to provide an indication of an uncontrolled descent from cruise level where flight crew incapacity prevents activation of the ADS-C emergency.

Note.— A VRE of negative 5000 feet per minute (descent rate) is suggested as a suitable value.

2.2.6.6.5 Route conformance

2.2.6.6.5.1 The ATSU may use the lateral deviation event (LDE) to detect deviations from the aircraft active flight plan.

2.2.6.6.6 Updating other information in the flight plan.

2.2.6.6.6.1 The ATSU may use the Mach number in the air reference group to monitor conformance with filed flight plan speed and provide updates as required.

2.2.6.6.7 Figure of merit

2.2.6.6.7.1 The ADS-C basic report contains a figure of merit (FOM) that provides the navigational accuracy of position data in the basic report in accordance with [Table 2-13](#).

Table 2-13. Figure of merit values

Figure of merit value	of Accuracy of position	of Remarks
0	Complete loss of navigational capabilities	Inability to determine position within 30 nautical miles is considered total loss of navigation. Includes the inability to associate a valid time with the position.
1	< 30 nm	Consistent with inertial navigation on long flight without updates.
2	< 15 nm	Consistent with inertial navigation on intermediate length flight without updates.
3	< 8 nm	Consistent with inertial navigation on short length flight and beyond 50 nautical miles from VOR.
4	< 4 nm	Consistent with VOR accuracies at 50 nautical miles or less and with GPS worldwide.
5	< 1 nm	Consistent with RHO-RHO applications of ground-based DME, RNAV using multiple DME or GPS position updates.
6	< 0.25 nm	Consistent with RNAV using GPS.
7	< 0.05 nm	Consistent with augmented GPS accuracies.

2.2.6.6.8 ADS-C reporting interval

2.2.6.6.8.1 While ADS-C reporting intervals are generally referred to in whole minutes, they are not actually defined that way in the ADS contract. The required ADS-C reporting interval is uplinked to the aircraft in one byte (eight bits) of data, in accordance with [Figure 2-50](#).

Reporting Interval = (1 + Rate) x SF, where			
Rate	is the value contained in bits one to six. These six bits allow a range of values between 0 and 63.		
SF	is the scaling factor in bits seven and eight where:		
	Bit 7	Bit 8	Definition
	0	0	0 seconds, used for a Demand Contract Request
	1	0	1 second
	0	1	8 seconds
1	1	64 seconds	

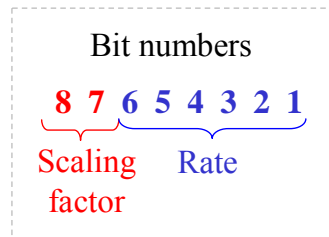

Figure 2-50. Calculation of ADS-C periodic reporting interval

2.2.6.6.8.2 For example, to establish a “40 minute” reporting interval, the SF would equal 64 seconds and the rate would equal 36. The actual reporting interval specified in the ADS contract would be $64 \times (1 + 36) = 2368$ seconds (39 minutes 28 seconds).

2.2.7 FMC WPR data link system

2.2.7.1 FMC WPR - general

2.2.7.1.1 An aircraft may be ACARS-capable, but not be CPDLC or ADS-C-capable. These aircraft can exchange data link messages with the operator’s aeronautical operational control (AOC) facility, but not with an ATSU.

2.2.7.1.2 The operator configures these aircraft to send ACARS position reports to their aeronautical operational control (AOC) facility for flight monitoring. Additional ground-based functionality can reformat the ACARS position report and forward it to an ATSU via AFTN as a replacement for voice position reports.

2.2.7.1.3 The method of delivery for the ACARS position report from an aircraft to an ATSU is referred to as flight management computer waypoint position reporting (FMC WPR).

2.2.7.1.4 FMC WPR provides the operator an alternative to FANS 1/A ADS-C position reporting, in cases where FANS 1/A equipage is impractical or cost prohibitive for the operator. FMC WPR is not intended to replace or delay FANS 1/A equipage.

2.2.7.2 Description

2.2.7.2.1 In some airspace, the aircraft sends the FMC waypoint position report to a central FMC waypoint reporting system (CFRS) or to the operator's AOC host computer. The CFRS or operator's AOC host computer converts the position report to a suitable format and delivers it via AFTN to appropriate ATSUs. A CFRS may also convert the report to standard AFTN format and deliver it to appropriate meteorological facilities to support weather forecasting.

Note.— *Because there is no format defined, formats may vary slightly between ATSUs. The CFRS or AOC host computer should support different formats for different ATSUs.*

2.2.7.2.2 [Appendix E](#) indicates which of the above two approaches each ATSU uses.

2.2.7.3 Position report - description

2.2.7.3.1 A logon request is not necessary to initiate FMC WPR.

2.2.7.3.2 An FMC WPR is a position report that:

- a) Consists entirely of data entered automatically by the FMS;
- b) Consists of data CRC protected by the FMS;
- c) Consists of data formatted and populated in accordance with the ARINC 702A; and
- d) Contains geographical coordinates in ICAO format (Refer to [paragraph 5.6.1.2](#)).

2.2.7.3.3 An FMC WPR can be initiated automatically or manually as prescribed by flight deck procedures (Refer to [paragraphs 3.2, 3.4, and 5.6.4](#)).

2.2.7.3.4 An operator participating in FMC WPR ensures that the FMC WPR:

- a) Is generated at each ATC waypoint of a cleared route; and
- b) Contains data only for an ATC waypoint.

Chapter 3. Administrative provisions related to data link operations

This chapter includes the prerequisites for data link operations, including service provision, operator eligibility, and flight planning.

3.1 ANSP service provision

3.1.1 ANSP system validation

3.1.1.1 The ANSP should ensure a validation process that confirms the integrity of their equipment and procedures meets system integrity requirements. This process should include:

a) A system safety assessment which demonstrates that the service provision meets the safety objectives. The ANSP should conduct a system safety assessment through a functional hazard analysis or a documented system safety case for initial implementation as well as for future enhancements. These assessments should include:

- 1) Identifying failure conditions;
- 2) Assigning levels of criticality;
- 3) Determining probabilities for occurrence; and
- 4) Identifying mitigating measures;

b) Integration test results confirming interoperability for operational use of the aircraft and ground systems; and

c) Confirmation that the ATS operation manuals are compatible with those of adjacent providers.

3.1.1.2 Following the safety assessment, the ANSP should institute measures through automation or procedures to mitigate the identified failure conditions. For example:

a) If the ANSP uses integrated measurement tools for the purpose of determining separation, they may need to publish limitations on the use of such tools for establishing and monitoring separation standards;

b) If an ANSP receives both an ADS-C and a CPDLC position report containing ETA that differ by 3 minutes or more, the controller should request confirmation of the estimate for the waypoint in question; and

c) To fulfill the requirements of Annex 10, paragraph 8.2.8, the controller should be provided with automation and/or procedures to ensure that the appropriate ATC unit has established an active CPDLC connection with the aircraft. Refer to [Appendix E](#) for the mitigating measures used for confirming CDA.

3.1.1.3 The ANSP should ensure that it provides communication services that meet the performance specifications provided at [Appendix B](#) and [Appendix C](#), and that the contracted CSP meets its performance allocations. The risks represented by the requirements are regarded as being minimum for the specified ATS function to maintain operational efficiency while meeting its required safety needs.

3.1.1.4 If the ANSP uses free text messages, it should include an evaluation of the effects associated with the use of free text messages in operational and system safety assessments. When the intent/use of the free text message impacts seamless operations, the ANSP should globally coordinate the

free text message to define the operational contents, format, and use as a new standardized free text message. The standardized free text messages are provided in [Appendix A, paragraph A.5](#).

a) The results of an operational assessment may conclude that a free text message needs to be pre-formatted and readily available for the flight crew or the controller because it is too workload intensive to manually enter the message. Pre-formatted free text messages should only be selected from standardized free text messages, which are appropriate for the intended use.

b) When the ANSP establishes procedures that require the controller or flight crew to use a free text message element to mimic ICAO Doc 4444 standard message elements, the ANSP should apply the following criteria:

1) The ground system should apply any range, resolution, and units of measure restrictions prior to use of the message;

2) The ground system and aircraft system should provide a human interface for message composition and recognition of free text messages consistent with operational, safety, and performance requirements associated with use of the free text message;

3) The ATSU should not use free text to mimic an ICAO Doc 4444 message element with a W/U response attribute, unless the free text is combined with a standard message element with a W/U response attribute as part of a multi-element message (see [paragraph 4.3.6](#)); and

4) When a free text message (with a R response attribute) is used to mimic a message element with a Y response attribute, the ATSU should provide procedures and/or automation to ensure the appropriate operational response is received.

Note.— *The ground system will technically close the uplink message when it receives the R response from the aircraft.*

3.1.1.5 The ANSP should conduct trials with aircraft to ensure that the system meets the requirements for interoperability such as is defined for FANS 1/A in RTCA DO-258A/EUROCAE ED-100A. Refer to [paragraph 2.1](#) for applicable interoperability standards for the different data link system.

3.1.1.6 The ANSP should develop appropriate procedures or other means to:

a) Respond to CPDLC downlink message elements defined in [Appendix A](#) (See [paragraph 3.1.4.2](#) for publication of unsupported downlink messages);

b) Ensure that data are correct and accurate, including any changes, and that security of such data is not compromised;

c) Notify adjacent ATSUs of system failures, software upgrades (or downgrades) or other changes, which may impact them. Such notification procedures will normally be detailed in letters of agreement between adjacent units; and

d) Ensure that the ATSU only establishes an ADS contract with aircraft for which that ATSU has direct control or monitoring responsibility.

Note.— *An ATSU may need to establish ADS contracts with aircraft operating in their area of responsibility for purposes other than direct control or monitoring (e.g. testing of ground system software before operational release).*

3.1.1.7 The ANSP should ensure that its controllers receive appropriate training in accordance with ICAO Annex 1 and obtain any necessary approval from the State.

3.1.2 ATC automated data link functions

3.1.2.1 Logon request

3.1.2.1.1 To ensure that CPDLC messages are sent only to aircraft for which the ATSU has a flight plan, the ATSU should reject a logon request if:

- a) There is no flight plan for the flight;
- b) The flight plan does not contain the aircraft registration/address; or
- c) The aircraft registration/address in the logon request message does not match the aircraft registration/address in the flight plan.

3.1.2.1.2 Hyphens or spaces contained in an aircraft registration are not valid characters in the ICAO flight plan and therefore are not present in the filed flight plan. The ground system should be configured to prevent the logon request being rejected due to hyphens or spaces being included in the aircraft registration sent in the logon request message, but not in the flight plan.

3.1.2.2 Transfers between FANS 1/A and ATN B1 adjacent ATSUs

3.1.2.2.1 To ensure transfers of CPDLC between FANS 1/A and ATN B1 areas, the ANSP should ensure its FANS 1/A and ATN B1 ATSUs comply with chapter 4 in ED-154A/DO-305A standard.

Note 1— Compliance with the full ED-154A/DO-305A standard is not required to support automatic CPDLC transfer. Only one particular requirement in chapter 4 applies to the T-ATSU:

a) FANS 1/A T-ATSU ground systems include, in the contact request message, a specific 7-character ACARS address based on the 4-character ICAO identifier of the ATN B1 R-ATSU combined with “ATN”.

b) ATN B1 and FANS 1/A-ATN B1 T-ATSU ground systems include, in the contact request message, a specific ATN address as a binary string made of zeroes.

Note 2— When ED-154A/DO-305A chapter 4 applies for a given transition, the T-ATSU behavior is systematic whatever the aircraft type.

Note 3.— Table 3-1 identifies the different combinations of transfers that can occur between two different types of ground systems and specifies when ED-154A/DO-305A chapter 4 applies to the T-ATSU, in addition to the standards per Table 2-1.

Table 3-1. Supporting technology for transfers between FANS 1/A and ATN B1

T-ATSU technology	R-ATSU technology	Aircraft technology	Additional standards to support CPDLC transfer	Resulting technology with R-ATSU
FANS 1/A	FANS 1/A	FANS 1/A	None	FANS 1/A
		ATN B1	Not applicable	Voice

T-ATSU technology	R-ATSU technology	Aircraft technology	Additional standards to support CPDLC transfer	Resulting technology with R-ATSU
		FANS 1/A-ATN B1	None	FANS 1/A
FANS 1/A	FANS 1/A-ATN B1	FANS 1/A	ED154A/DO305A Chapter 4.2.2 (IR-208) for ground FANS 1/A T-ATSU	FANS 1/A
		ATN B1	Not supported	No CPDLC with T-ATSU. <i>Note.— ATN B1 may be used after a manual logon procedure is initiated.</i>
		FANS 1/A-ATN B1	ED154A/DO305A Chapter 4.2.2 (IR-208) for ground FANS 1/A T-ATSU	ATN B1 <i>Note.— Some aircraft (see Appendix E, paragraph F.1) implement both FANS 1/A and ATN B1 capabilities as separate systems and do not comply with ED154A/DO305A. For such aircraft, the transfer results in using FANS 1/A for the receiving ATSU.</i>
FANS 1/A	ATN B1	FANS 1/A	Not supported	Voice
		ATN B1	Not supported	No CPDLC with T-ATSU. <i>Note.— ATN B1 may be used after a manual logon procedure is initiated.</i>
		FANS 1/A-ATN B1	ED154A/DO305A Chapter 4.2.2 (IR-208) for ground FANS 1/A T-ATSU	ATN B1 <i>Note.— Some aircraft (see Appendix E, paragraph F.1) implement both FANS 1/A and ATN B1 capabilities as separate systems and do not comply with ED154A/DO305A. Such aircraft do not benefit from automatic transfer. ATN B1 may be used after a manual logon procedure is initiated.</i>
FANS 1/A-ATN B1	FANS 1/A	FANS 1/A	None	FANS 1/A
		ATN B1	Not supported	Voice
		FANS 1/A-ATN B1	ED154A/DO305A Chapter 4.3.2 (IR-213) for ground FANS 1/A-ATN B1 T-ATSU	FANS 1/A <i>Note.— Some aircraft (see Appendix E, paragraph F.1) implement FANS 1/A and ATN B1 capabilities as separate systems and do not comply with ED154A/DO305A. Such aircraft may be using FANS 1/A with T-ATSU. The transfer will succeed as a nominal FANS 1/A to FANS 1/A transfer.</i>

T-ATSU technology	R-ATSU technology	Aircraft technology	Additional standards to support CPDLC transfer	Resulting technology with R-ATSU
FANS 1/A-ATN B1	FANS 1/A-ATN B1	FANS 1/A	None	FANS 1/A
		ATN B1	None	ATN B1
		FANS 1/A-ATN B1	None	Same as with T-ATSU (ATN B1 or FANS 1/A)
FANS 1/A-ATN B1	ATN B1	FANS 1/A	Not supported	Voice
		ATN B1	None	ATN B1
		FANS 1/A-ATN B1	None	ATN B1 <i>Note.— Some aircraft (see Appendix E, paragraph F.1) implement FANS 1/A and ATN B1 capabilities as separate systems and do not comply with ED154A/DO305A. Such aircraft may be using FANS 1/A with T-ATSU and do not benefit from automatic transfer. ATN B1 may be used after a manual logon procedure is initiated.</i>
ATN B1	FANS 1/A	FANS 1/A	Not supported	No CPDLC with T-ATSU. <i>Note.— FANS 1/A may be used after manual logon procedure.</i>
		ATN B1	Not supported	Voice
		FANS 1/A-ATN B1	ED154A/DO305A Chapter 4.3.2 (IR-213) for ground ATN B1 T-ATSU	FANS 1/A <i>Note.— Some aircraft (see Appendix E, paragraph F.1) implement FANS 1/A and ATN B1 capabilities as separate systems and do not comply with ED154A/DO305A. Such aircraft do not benefit from automatic transfer. FANS 1/A may be used after a manual logon procedure is initiated.</i>
ATN B1	FANS 1/A-ATN B1	FANS 1/A	Not supported	No CPDLC with T-ATSU. <i>Note.— FANS 1/A may be used after manual logon procedure.</i>
		ATN B1	None	ATN B1
		FANS 1/A-ATN B1	None	ATN B1
ATN B1	ATN B1	FANS 1/A	Not supported	Voice
		ATN B1	None	ATN B1
		FANS 1/A-ATN B1	None	ATN B1

3.1.2.3 CPDLC and ADS-C connection management

3.1.2.3.1 To prevent the aircraft rejecting the CPDLC connection request message from the receiving ATSU, the CDA should ensure completion of the NDA process prior to initiating address forwarding to the next ATSU.

3.1.2.3.2 To avoid interruption of data link service, the ATSU should:

a) Initiate address forwarding at an agreed time prior to the estimated time at the boundary of a downstream unit; or

b) When short transit times preclude this, as soon as possible after becoming CDA. Confirmation of CDA status may be necessary to ensure that the NDA message, which needs to precede address forwarding, is not rejected by the aircraft (see [paragraph 4.2.4](#)).

3.1.2.3.3 If the ground system does not receive the contact complete message within a specified time (e.g. 15 minutes) from sending the contact request message, it should provide an indication to the controller. Refer to [paragraph 4.2.2.3](#) for associated controller procedures.

3.1.2.3.4 If open uplink or downlink messages exist for the aircraft, the ground system should provide indication to the controller and confirm messages are closed prior to sending the CPDLC termination request message.

3.1.2.3.5 When a CPDLC connection cannot be established by any ATSU, the ground system should indicate to the controller at that ATSU that no connection has been established.

3.1.2.4 Emergency message element handling

3.1.2.4.1 The ground system should provide a clear indication to the controller of downlinked messages that contain any of the message elements from the emergency message elements (see [Appendix A, paragraph A.4](#), for the list of emergency message elements.)

3.1.2.4.2 When the ground system receives an emergency-mode ADS-C report, it should present it to the controller. If a periodic contract is active, the emergency report will be transmitted at the existing periodic interval. Otherwise, the interval will default to a value determined by the aircraft system (see [Appendix F, paragraph F.10](#)). Only the flight crew can cancel the emergency mode (see [paragraph 4.8.3](#) for associated controller procedures).

3.1.2.5 Automated responses

3.1.2.5.1 With the exception of [UM 1](#) STANDBY or [UM 2](#) REQUEST DEFERRED, the ground system should assign an MRN to only one uplink message in response to a particular downlink message. If the ground system sends two separate messages with the same MRN, and neither of the messages is [UM 1](#) or [UM 2](#), the aircraft system will discard the second message and not display it to the flight crew.

3.1.2.5.2 The ground system should only assign a MRN to an uplink message that is responding to a downlink message with the associated MIN and the downlink message requires a response. If the ATSU sends an uplink message with a MRN and the downlink message with the associated MIN did not require a response, the aircraft system will discard the uplink message and not display it to the flight crew.

Note.— If an uplink message is discarded for the reasons described in [paragraph 3.1.2.5.1](#) or [paragraph 3.1.2.5.2](#), the aircraft system will send an error message to the ground system indicating that the MRN was not recognized.

3.1.2.5.3 If a downlink message contains a message element that is not supported, then the ATSU should:

- a) For a FANS 1/A ATSU, send CPDLC free text [UM 169u](#) MESSAGE NOT SUPPORTED BY THIS ATS UNIT rather than terminating the connection; or
- b) For an ATN B1 ATSU, send [UM 162](#) MESSAGE NOT SUPPORTED BY THIS ATS UNIT or SERVICE UNAVAILABLE.

Note.— For [UM 162](#), some FANS 1/A aircraft may display SERVICE UNAVAILABLE, which may be confusing to the flight crew. An ATN B1 aircraft will display MESSAGE NOT SUPPORTED BY THIS ATS UNIT.

3.1.2.5.4 ATSUs may automate the sending of the CPDLC termination request message, based upon the estimated time or location the aircraft is expected to cross the boundary. Refer to [paragraph 2.2.4](#) and [paragraph 4.2](#) for the proper sequence and timing for sending the CPDLC termination request message and associated controller procedures. Refer to [paragraph 3.1.4.8](#) for guidance on detailing the parameters for this operation in interfacility agreements.

3.1.2.6 Message latency monitor

3.1.2.6.1 An ATSU may implement automation to support use of a message latency monitor on the aircraft. The extent to which automation supports controller procedures that use the message latency monitor is a local matter.

3.1.2.6.2 The use of the message latency monitor, available on all ATN B1 aircraft and FANS 1/A+ aircraft, can provide the ANSP a means to mitigate the effects of a delayed CPDLC message that is delivered to the aircraft, and contributes to meeting the safety requirements for the ATSU and the aircraft. Refer to [Appendix B](#) for specific safety requirements associated with each RCP specification.

3.1.2.6.3 The ANSP should consider the effects of a delayed CPDLC message in accordance with [paragraph 3.1.1.1](#) and identify mitigating measures.

Note 1.— A FANS 1/A ATSU or a FANS 1/A–ATN B1 ATSU, providing CPDLC services to FANS 1/A aircraft, does not use the message latency monitor. To mitigate the effects of a delayed CPDLC message, the ATSU may apply the following alternative mitigation measures:

- a) Specify, in a contract or service agreement with the communication service provider, provisions that would preclude the delivery of a delayed CPDLC message to an aircraft; or
- b) Perform the procedure from [paragraph 4.3.1.2 a\)](#); or
- c) For FANS 1/A–ATN B1 ATSU, perform the procedure from [paragraph 4.3.1.2 c\)](#).

Note 2.— An ATN B1 ATSU or a FANS 1/A–ATN B1 ATSU that provides CPDLC services to ATN B1 aircraft may use the message latency monitor as mitigation against a delayed CPDLC message. The procedures are applicable only in the European Region and are described in [Appendix E, paragraph E.4.3.2](#).

3.1.2.7 Abnormal cases with ADS-C

3.1.2.7.1 When more than one ADS-C report for the same waypoint (or position) are received, the ground system should update the flight data with the first report and provide an indication to the controller if there are significant discrepancies in subsequent reports.

3.1.2.7.2 When the time stamp in the basic group is determined to be invalid for the position in an ADS-C report, the ground system should not use it to update any flight data.

Note 1.— When the time stamp is invalid, the figure of merit (FOM) will be set to 0 and any value could be expected in the basic group.

Note 2.— The time stamp in a FANS I/A ADS-C report is provided only as seconds past the last hour. Therefore, when an ADS-C report is received with a time stamp greater than the current ground system seconds past the hour, the time stamp in the report may be related to the previous hour (possibly even the previous day/month/year). The ground system may need to determine the full time stamp (i.e. including hours/day/month/year) for the ADS-C report when determining the validity of the time stamp with the associated position in the ADS-C report.

3.1.2.7.3 If the aircraft is in heading select mode and the aircraft passes abeam an ATC waypoint by more than a defined distance, the FMS will not sequence this or subsequent waypoints. Consequently, the aircraft will not send an ADS-C waypoint change event report. However, if the aircraft sends an ADS-C periodic report with a predicted route group, the NEXT waypoint data in the report will continue to indicate the waypoint that was passed. As a result, the ground system could use invalid data for display of the aircraft position or extrapolating the correct route for the aircraft. Refer to [paragraph 5.6.1.1](#) for flight crew procedures.

Note.— When the aircraft is in heading select mode, the intent and predicted route information transmitted by the aircraft will contain the next waypoint in the aircraft active flight plan regardless of the actual position and heading of the aircraft. Predicted information is based on the FMS intent, which may not necessarily reflect the intentions of the flight crew.

3.1.2.8 Satcom channel numbers in CPDLC messages

3.1.2.8.1 The CPDLC standard provides a [FrequencySatchannel] variable that is intended for ATSU's to send satellite voice telephone numbers in MONITOR and CONTACT messages ([UM 117](#) to [UM 122](#)). However, the decoding of this variable varies by aircraft type. Therefore, the ATSU should not use this variable in these messages unless the ground system can determine the appropriate decoding in use by the receiving aircraft and encode the uplink accordingly.

3.1.3 Contractual considerations for CSP

3.1.3.1 The CSP should meet the performance criteria for communication services, in accordance with [Appendix B](#) and [Appendix C](#).

3.1.3.2 If an aircraft generated downlink message passes all validation criteria, the CSP should send an acknowledgement (ACK) to the aircraft and deliver the message to the address identified in the downlink message.

Note.— If the message is not delivered to the address identified in the downlink message, the CSP should not send an acknowledgement (ACK) to the aircraft.

3.1.3.3 For those situations when a CSP cannot continue to provide data communications, it should inform ANSPs and operators in accordance with established coordination procedures.

Note.— A CSP that holds a contract with an operator per [paragraph 3.2.1.8](#) but not with the ANSP should notify the ANSP when such situations occur and that operator is conducting data link operations in the ANSP's airspace.

3.1.3.4 In the event of a centralized ADS-C (CADS) failure, the CSP for the CADS service should inform ATS.

3.1.3.5 In the event of a CFRS failure, the CSP for the CFRS service should inform ATS.

3.1.4 Aeronautical information, notifications, and interfacility agreements

3.1.4.1 The ANSP should notify operators of data link services using the AIP (or other appropriate publication). Notification includes:

- a) The ICAO 4-letter location indicator assigned to the ATSU serving the airspace;
 - b) Logon address, The logon address should preferably match the 4-letter location indicator. The ANSP should ensure that the logon address for the ATSU serving the airspace is provided on the appropriate aeronautical charts (ICAO Annex 4);
 - c) Applications, including for each application; application name, version interoperability coverage, scheduled service, shutdowns, and information/alert bulletins;
 - d) Differences between national regulations and practices, and related ICAO SARPs and procedures;
 - e) Requirements for use, for example:
 - 1) Procedures for initiation - When an ATSU is unable to accept a logon request sent between 15 and 25 minutes prior to either the ETD or the estimate for entering its airspace, the ANSP should publish in appropriate AIP (or other appropriate publication) the criteria for when a logon request will be accepted. Refer to [paragraph 2.2.3.1.2](#);
 - 2) ADS-C and CPDLC position reporting requirements;
- Note.*— The AIP may specify that ADS-C reports may fulfill all normal position reporting requirements. Refer to [paragraph 5.6.3](#) for position reporting guidelines in an ADS-C environment.
- 3) Supporting reduced separations, re-routes, tailored arrival and associated RCP and/or RSP specification(s); and
 - 4) Any required functionality, such as the message latency monitor provided by FANS 1/A+ aircraft (Refer to [paragraph 3.1.2.6](#)); and
 - f) Flight plan form and submission requirements.

3.1.4.2 The ANSP should support all downlink message elements as defined in [Appendix A](#), unless the ANSP publishes the differences in the appropriate regional/State supplement along with procedures for handling unsupported message elements.

Note 1.— Emergency messages, as a minimum, are displayed to the controller per [paragraph 3.1.2.4](#).

Note 2.— When a reduced CPDLC message set is used across a group of adjoining ATSU, the ANSP(s) need to ensure that the reduced message set is common and adequate for the applicable airspace.

3.1.4.3 An ANSP may suspend ADS-C, FMC WPR and/or CPDLC use (including trials) for the control area under its jurisdiction. Notification to affected ATSU should be carried out in accordance with coordination requirements specified in applicable interfacility agreements.

3.1.4.4 The ANSP should issue a timely NOTAM for scheduled and/or extended outages of the ADS-C or FMC WPR service and advise the operators to conduct position reporting via CPDLC or voice communications.

3.1.4.5 When an ANSP suspends CPDLC operations or when a planned system shutdown of the communications network or the ATS system occurs, the ANSP should publish a NOTAM to inform all affected parties of the shutdown period and advise operators to use voice communications during that time. The ANSP should ensure procedures are established for the ATSU to notify flight crews by voice or CPDLC of any imminent loss of CPDLC service.

3.1.4.6 In the event of an unexpected outage of ADS-C service, the ANSP should establish interfacility agreements with other ATSU concerned and issue a NOTAM if required to inform affected parties.

3.1.4.7 In the event of an unexpected outage of CPDLC service, or if an ATSU suspends CPDLC operations without prior notice, the ANSP should:

- a) Inform aircraft currently in communication with the ATSU of the loss of CPDLC service;
- b) Inform other ATSU concerned;
- c) Specifically advise whether the outage also affects ADS-C service; and
- d) Issue a NOTAM, if required.

3.1.4.8 When one or more ANSPs provide CPDLC service with adjoining ATSU, the ANSP(s) should establish interfacility agreements to allow the uninterrupted transfer of the CPDLC connection. The interfacility agreements should include:

- a) The time or location at which address forwarding occurs taking into consideration any automation requirements;
- b) The time at which CPDLC termination request message is sent (see [paragraph 3.1.2.5.4](#) regarding related ATC automation and [paragraph 4.1.2](#) for associated ATC procedures) taking into consideration:
 - 1) Sufficient time to allow the NDA (if established) to establish an active CPDLC connection prior to the aircraft crossing the common boundary; and
 - 2) Sufficient time to prevent an inappropriate active CPDLC connection from continuing with an aircraft while it is transiting airspace where CPDLC is not available.

3.1.4.9 When an ATSU will only have control of a CPDLC-capable aircraft for a relatively short duration, the ANSP may establish procedures in appropriate interfacility agreements to coordinate the transfer of communications for the aircraft among the controlling and the affected ATSU. Refer to [paragraph 4.2.4](#).

3.1.4.10 The ANSP should establish interfacility agreements, as appropriate, to ensure that adjacent FIRs can establish ADS contracts to monitor aircraft in the vicinity of the common boundary.

3.1.4.11 When CPDLC is used to assign frequencies, the ANSP should establish the frequencies to be used by interfacility agreements.

3.1.4.12 If the message latency monitor described in [paragraph 3.1.2.6](#) is used, the ANSP should establish interfacility agreements, as necessary, to ensure that its use or non-use is consistent with data link operations in airspace controlled by any of the adjacent ATSU.

3.1.5 Monitoring and data recording

3.1.5.1 The CNS/ATM environment is an integrated system including physical systems (hardware, software, and communication network), human elements (the flight crew and the controller), and the related procedures.

3.1.5.2 The ANSP should establish end-to-end system monitoring in accordance with the guidelines provided in [Appendix D](#). The guidelines aim to ensure end-to-end system integrity through post-implementation monitoring, identifying, reporting and tracking of problems, and corrective action.

Note.— The guidelines presented herein do not replace the ATS incident reporting standards and guidelines, as specified in ICAO Doc 4444, Appendix 4; ICAO Air Traffic Services Planning Manual (Doc 9426), Chapter 3; or applicable State regulations, affecting the parties directly involved in a potential ATS incident.

3.1.5.3 The ANSP and its CSP(s) should retain records for at least 30 days to allow for accident/incident investigation purposes. The ANSP and CSPs should make these records available for air safety investigative purposes on demand. These recordings should allow replaying of the situation and identifying the messages that the ATSU sent or received.

3.2 Operator eligibility

3.2.1 Operational authorization to use data link

3.2.1.1 An operator intending to use CPDLC or ADS-C service should obtain an operational authorization with the State of registry or State of the operator, if required, in accordance with their rules and means of compliance. This operational authorization should address flight crew training and qualification, maintenance, MEL, user modifiable software, service agreements with the CSP, and procedures for submitting problem reports and data to the regional/State monitoring agencies. The operator should also ensure that aircraft equipment has been approved for the intended use per interoperability standards (e.g. FANS 1/A or ATN B1), described in [paragraph 2.1.2](#), performance specifications (e.g. RCP 240 or RCP 400), described in [paragraph 2.1.3](#), and in accordance with airworthiness requirements and related means of compliance.

3.2.1.2 The operator is not required to obtain an operational authorization to use FMC WPR. However, the operator should ensure that the aircraft equipment has been approved by the State of

Registry or State of the Operator for FMC WPR (e.g. meets appropriate software assurance criteria). See [paragraph 3.4](#) for additional guidance on operational use of FMC WPR.

3.2.1.3 The operator should establish policy and procedures for flight crews and operational staff involved in data link operations, and incorporate them in appropriate operations manuals. The operations manuals should include:

a) Procedures for use of the data link system specific to the aircraft type in accordance with operating manuals provided by the aircraft or system manufacturer;

Note.— See [Appendix F, paragraph F.4](#), for aircraft-specific display of responses and acknowledgements to CPDLC messages and any constraints on processing these responses and acknowledgements.

b) Procedures for the data link operations taking into account the guidance provided in [Chapter 5](#) and [Chapter 6](#), as necessary;

c) Minimum equipment lists (MEL) modifications (if required); and

d) Flight crew and operational staff procedures, including procedures for establishing and maintaining voice communications (including any required SELCAL check(s)) with every ATSU along the route of flight.

3.2.1.4 The operator should ensure the flight crews and operational staff (e.g. dispatcher) receives appropriate training in accordance with Annex 1 and Annex 6 to the Convention on International Civil Aviation.

3.2.1.5 If applicable, the operator should ensure the operational staff is trained in data link operations. This training should include:

a) Description of the data link system, including applications, network and subnetworks;

b) Flight planning requirements for data link flights;

c) Implications of flights departing under minimum equipment list (MEL) relief; and

d) Implications of planned and unplanned network outages on data link operations.

3.2.1.6 From time to time aircraft manufacturers release new software which will often rectify in service issues and may add increased functionality. The operator should update their software as new releases become available to ensure best possible performance.

3.2.1.7 The operator should initially coordinate with its CSP(s) to initiate ground system configuration for its aircraft. In operations involving CFRS, to ensure FMC WPR downlinks are properly routed to the appropriate CFRS system(s), the operator should coordinate with their CSP(s) to configure for routing their FMC WPRs to the appropriate CFRS system(s).

3.2.1.8 The operator should ensure that their CSP(s) meets the performance criteria for communication services, in accordance with [Appendix B](#) and [Appendix C](#), and notifies them and appropriate ANSPs when data communication services as prescribed for the intended operations cannot be provided.

3.2.1.9 The operator should ensure that flight operations, the flight crews and the appropriate ANSPs are notified of failures with the aircraft equipment or the operator's AOC system related to data link operations (such as when used to provide FMC WPR service to ANSPs).

3.2.1.10 The operator should provide flight operations and the flight crew with procedures, as appropriate, when the following occurs:

- a) The operator is notified of data link system failures per [paragraph 3.2.1.8](#); or
- b) The AOC system or aircraft equipment fails such that the aircraft capability can no longer meet the performance specifications ([Appendix B](#) and [Appendix C](#)) prescribed for the intended operation.

3.2.1.11 The operator may be required to make special arrangements with an ATSU for the purposes of undertaking trials using ATC data link equipment.

3.2.2 Regional/State monitoring agencies

Note.— *Guidelines on problem reporting and corrective action can be found at [Appendix D](#). Contact information for the appropriate regional/State monitoring agency can be found at [Appendix E](#).*

3.2.2.1 The operator should indicate their intention to participate in data link operations by contacting the appropriate regional/State monitoring agency and providing the following information thirty days in advance:

- a) Operator name;
- b) Operator contact person; and
- c) The appropriate 8-letter aeronautical fixed telecommunication network (AFTN) address(es) if the operator requires receipt of converted ADS-C waypoint change event reports or FMC waypoint position reports.

3.2.2.2 If any of the information provided in [paragraph 3.2.2.1](#) changes, the operator should advise the appropriate regional/State monitoring agency.

3.2.2.3 The operator should establish procedures to report to the appropriate regional/State monitoring agency, as soon as practicable, any problems its flight crews and dispatchers have with data link operations.

Note.— *Filing a report with regional/State monitoring agencies does not replace the ATS incident reporting procedures and requirements, as specified in ICAO Doc 4444, Appendix 4; ICAO Doc 9426, Chapter 3; or applicable State regulations affecting parties involved in a potential ATS incident.*

3.3 Flight planning

3.3.1 General

3.3.1.1 When filing data link capability, the operator should ensure that the planned use of data link for the flight will be in accordance with regulations, policies and procedures applicable in individual

States and/or FIRs for the flight, as published in documents such as regional supplementary (SUPPs) procedures and AIPs (or other appropriate publications).

Note.— Refer to [paragraph 3.2](#) for guidance on operator eligibility to participate CPDLC and ADS-C operations and [paragraph 3.4](#) to participate in FMC WPR.

3.3.1.2 The operator should ensure that the proper information is included in the ICAO flight plan.

Note.— Refer to ICAO Doc 4444, Appendix 2, for flight plan requirements.

3.3.2 CPDLC and ADS-C

3.3.2.1 In Item 10 of the flight plan, the operator should insert one or more of the descriptors, as appropriate, listed in [Table 3-2](#), to identify an aircraft's data link equipment and capabilities:

Table 3-2 Descriptors for CPDLC/ADS-C equipment and capabilities in Item 10

Item 10a - CPDLC equipment and capabilities	Descriptor
CPDLC ATN VDL Mode 2 (ATN B1)	J1
CPDLC FANS 1/A HFDL	J2
CPDLC FANS 1/A VDL Mode 0/A	J3
CPDLC FANS 1/A VDL Mode 2	J4
CPDLC FANS 1/A SATCOM (INMARSAT)	J5
CPDLC FANS 1/A SATCOM (MTSAT)	J6
CPDLC FANS 1/A SATCOM (Iridium)	J7
RCP 400	P1
RCP 240	P2

Item 10b – ADS-C equipment and capabilities	Descriptor
ADS-C with FANS 1/A capabilities	D1
ADS-C with ATN capabilities	G1

3.3.2.2 In Item 18 of the flight plan, the operator should insert the following other information relevant to CPDLC and ADS-C equipment and capabilities:

- a) The indicator REG/ followed by the aircraft registration;
- b) The indicator CODE/ followed by the aircraft address expressed in the form of an alphanumerical code of six hexadecimal characters; and
- c) The indicator SUR/ followed by RSP400 or RSP180, as appropriate.

Note 1.— The ATSU compares information contained in the flight plan, which may also include aircraft identification (item 7), departure aerodrome (item 13) and destination aerodrome (item 16) with the information contained in the logon request message prior to accepting the logon request ([paragraph 2.2.3.2](#) refers).

Note 2.— The hyphen is not a valid character to include in a flight plan. Any hyphen that may be contained in the aircraft registration needs to be omitted when including the aircraft registration in the flight plan.

3.3.3 FMC WPR

3.3.3.1 In Item 10a of the flight plan, the operator should insert the “E1” descriptor, to identify an aircraft’s FMC WPR capability.

Note.— The aircraft identification (ACID) provided in the FMC WPR is correlated with the ID provided in the filed flight plan and will be rejected if they do not match.

3.4 FMC WPR – additional guidance

3.4.1.1 In addition to the guidelines provided in [paragraph 3.2](#), an operator who intends to participate in FMC WPR data link operations should advise participating ANSPs of the following information at least thirty days in advance:

- a) Whether the FMC WPRs will be manually triggered by the flight crew or be fully automated;
- b) That the necessary coordination has taken place with the CSP, in operations involving a CFRS; and
- c) The aircraft type(s) and associated aircraft registration(s) of aircraft, in operations involving a CFRS, since CFRS reports can only be received from aircraft whose aircraft registration is known to the system.

3.4.1.2 The participating operator should demonstrate to the appropriate planning and implementation regional group (PIRG) that they meet the RSP specifications (see [Appendix C](#)) for the provision of FMC WPRs for ATS purposes. Once this has been demonstrated, the operator will be able to participate in FMC WPR operations. Utilizing FMC WPR will be at the discretion of the operator.

3.4.1.3 An operator participating in FMC WPR should ensure that:

- a) The FMC WPR is generated at each ATC waypoint of a cleared route in airspace where FMC WPR is available;
- b) Any waypoint uplinked to the FMS for the purposes of generating automatically initiated FMC WPRs is an ATC waypoint; and
- c) The FMC WPR contains the data elements that are required for ATC, per ICAO Doc 4444.

3.4.1.4 The operator should use numeric characters in the flight identification portion (e.g. ABC123) of the aircraft identification. When use of alphabetic characters (e.g. ABC123A) in the flight identification is unavoidable, the operator should ensure the flight crew provides position reports by voice.

Note.— Per ARINC 618, the flight identifier in the ACARS downlink message consists of a two character airline identifier and a four character flight number field. Aircraft identifications such as ABC124A (flight identification 124A) or ABC324W (flight identification 324W) cannot be encoded in the ACARS message, therefore making FMC WPR for these flights unavailable.

3.4.1.5 Early versions of Airbus software are prone to large errors in position data. Operators should ensure they have updated software before using FMC WPR.

Chapter 4. Controller and radio operator procedures

4.1 Overview

4.1.1 General

4.1.1.1 This chapter provides guidance on procedures and recommended practices for the controller and the radio operator in airspace where data link services are available.

4.1.1.2 This information is intended to assist in the development of:

- a) Local procedures and associated documentation; and
- b) Appropriate training programs.

4.1.1.3 Controllers should be knowledgeable in the ATC automation. Refer to [paragraph 3.1.2](#) for guidelines for implementation of ground systems supporting data link operations.

4.1.1.4 Controllers should be knowledgeable in data link operations. Refer to [Chapter 2](#) for an overview of data link operations.

4.1.1.5 Radio operator procedures specific to data link operations can be found in [paragraphs 4.9 and 4.9.3](#).

4.1.2 When to use voice and when to use CPDLC

4.1.2.1 When communicating with an aircraft that is operating within airspace beyond the range of DCPC VHF voice communication, CPDLC is available and local ATC procedures do not state otherwise, the controller should normally choose CPDLC as the means of communication. The controller would use voice as an alternative means of communication (e.g. VHF, HF or SATVOICE direct or via a radio operator). However, in any case, the controller will determine the appropriate communication medium to use at any given time.

4.1.2.2 In airspace where both DCPC VHF voice and CPDLC communication services are provided, and local ATC procedures do not state otherwise, the controller will determine the appropriate communication medium to use at any given time.

Note.— ICAO Doc 4444, paragraph 8.3.2, requires that DCPC be established prior to the provision of ATS surveillance services, unless special circumstances, such as emergencies, dictate otherwise. This does not prevent the use of CPDLC for ATC communications, voice being immediately available for intervention and to address non-routine and time critical situations.

4.1.2.3 To minimize pilot head down time and potential distractions during critical phases of flight, the controller should use voice to communicate with aircraft operating below 10,000 ft AGL.

4.1.2.4 While the CPDLC message set, as defined in [Appendix A](#), generally provides message elements for common ATC communications, the controller may determine voice to be a more appropriate means depending on the circumstances (e.g. some types of non-routine communications).

Note 1.— Refer to [paragraph 4.8](#) and [paragraph 4.9](#) for guidelines on use of voice and data communications in emergency and non-routine situations, respectively.

Note 2.— During an emergency, the flight crew would normally revert to voice communications. However, the flight crew may use CPDLC for emergency communications depending on the situation. Refer to [paragraph 5.8.1](#) for flight crew procedures on use of voice and data communications in emergency situations.

4.1.2.5 The controller should respond to a CPDLC message via CPDLC, and should respond to a voice message via voice.

4.1.2.6 If a conflicting CPDLC and voice communication is received, the controller should obtain clarification using voice.

4.2 CPDLC connection management and voice communication transfers

4.2.1 General

4.2.1.1 The ATSU should manage its CPDLC connections, including initiating, transferring and terminating the connection when no longer needed.

Note.— The controlling ATSU coordinates with the next ATSU, establishing clearly when or where the address forwarding will have to occur.

4.2.1.2 An ATSU may have an active connection with an aircraft not in that ATSU's airspace. Some examples are:

- a) When the aircraft is within a non-CPDLC service area and the flight crew initiates a logon to the next controlling ATSU which is a CPDLC service area;
 - b) During the CPDLC connection transfer process;
 - c) Where the active connection is retained by the transferring ATSU subject to prior coordination;
- or
- d) In emergency circumstances.

4.2.1.3 Regardless of its connection status, an ATSU should never issue a clearance or instruction to an aircraft outside its control area unless it has been coordinated with the ATSU in whose airspace the aircraft is operating.

4.2.1.4 The ATSU should conduct any transfer of the CPDLC connection, or termination when the aircraft leaves CPDLC airspace, in conjunction with an instruction (CONTACT or MONITOR) identifying the appropriate ATSU for further communication.

4.2.2 Establish CPDLC connection

Note.— See [paragraph 2.2.4](#) for a description of CPDLC connection management.

4.2.2.1 The first ATSU should establish a CPDLC connection if no previous CPDLC connection exists with the aircraft.

4.2.2.2 The next ATSU should establish a CPDLC connection prior to the CDA terminating the active CPDLC connection.

4.2.2.3 An ATSU should confirm that its CPDLC connection is active as soon as practicable after the controller has assumed control of the aircraft, using one of the following methods:

- a) For FANS 1/A, receipt of a **DM 3** ROGER in response to **UM 169** [free text];
- b) For FANS 1/A, receipt of a **DM 48** POSITION REPORT [position report], either initiated by the flight crew or in response to **UM 147** REQUEST POSITION REPORT; or
- c) For ATN B1, receipt of a **DM 99** CURRENT DATA AUTHORITY message; or

*Note 1.— If the receiving ATSU has not confirmed its CPDLC connection as being active, the receipt of any response to an uplink (other than **DM 63** NOT CURRENT DATA AUTHORITY), or any unsolicited downlink message, will confirm that the connection is active.*

*Note 2.— Refer **Appendix E** for regional/State differences.*

4.2.3 Transfer voice communications with CPDLC connection transfer

4.2.3.1 When using CPDLC to effect voice communications transfers, the CDA should complete the voice frequency change process with the CPDLC connection transfer, as shown in **Figure 4-1**, using the CONTACT/MONITOR message elements (**UM 117** through **UM 122**):

a) If the frequency change is to be made immediately, sending **UM 117** CONTACT [unit name] [frequency] or **UM 120** MONITOR [unit name] [frequency] and then, as soon as possible after the receipt of the **DM 0** WILCO response to the CONTACT or MONITOR message, terminate the CPDLC connection; or

*Note.— For ATN B1, the termination request message is sent as a multi-element message that includes **UM 117** or **UM 120**, while the termination confirmation is sent as a multi-element message that includes the WILCO response. Refer to **paragraph 2.2.4.8.3** for CPDLC termination.*

b) If the frequency change is to be made at some time or position in the future, such as at the boundary, sending **UM 118** or **UM 119** AT [position/time] CONTACT [unit name] [frequency] or **UM 121** or **UM 122** AT [position/time] MONITOR [unit name] [frequency] and then, after the receipt of the **DM 0** WILCO response, terminate the CPDLC connection in accordance with interfacility agreements (See **paragraph 3.1.4.8**).

4.2.3.2 When using the (**UM 117** through **UM 122**) CONTACT/MONITOR message elements, the CDA should use the facility name for the [unit name] parameter.

*Note.— See **Appendix F**, **paragraph F.9** for aircraft that do not support a <space> within the [unit name] parameter.*

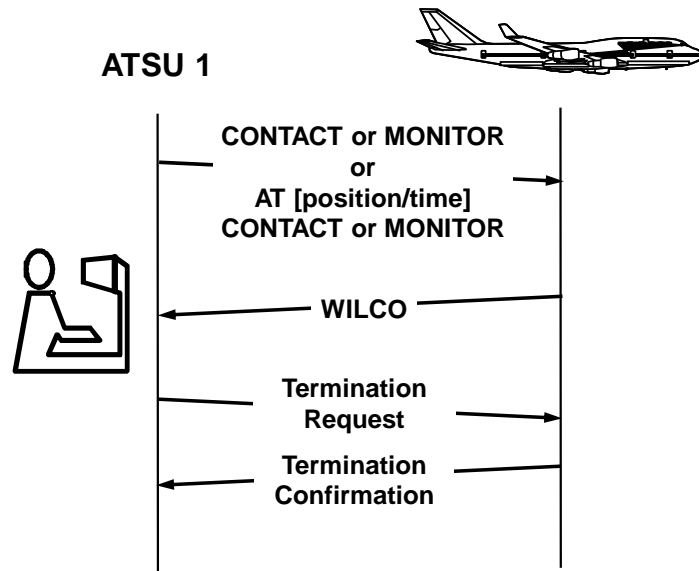

Figure 4-1. CPDLC connection transfer - separate messages

4.2.3.3 Since the CONTACT/MONITOR message elements listed in [Table 4-1](#) include only one [frequency] parameter, the controller should only use these message elements when instructing the flight crew to change the primary frequency. In areas of poor radio coverage, the controller may append CPDLC free text [UM 169o](#) SECONDARY FREQUENCY [frequency] to specify a secondary frequency.

Table 4-1. CONTACT/MONITOR message elements

Ref #	Message element
UM 117	CONTACT [unit name] [frequency]
UM 118	AT [position] CONTACT [unit name] [frequency]
UM 119	AT [time] CONTACT [unit name] [frequency]
UM 120	MONITOR [unit name] [frequency]
UM 121	AT [position] MONITOR [unit name] [frequency]
UM 122	AT [time] MONITOR [unit name] [frequency]

4.2.3.4 In the FANS 1/A CPDLC message set, the option of RADIO per ICAO Annex 10, Volume II, paragraph 5.2.1.7.1.2 is not a possible value for the [unit name] parameter used in CONTACT and MONITOR messages. In the absence of this option, some ANSPs use CENTER to apply to an aeronautical station (RADIO). Other ANSPs use CPDLC free text to mimic the MONITOR/CONTACT instructions and indicate the facility name followed by RADIO.

4.2.4 Termination of the CPDLC connection

4.2.4.1 Normally, the transferring ATSU should terminate the CPDLC connection prior to the aircraft crossing a common boundary with the next ATSU. If for operational reasons the transferring ATSU needs to delay the transfer until after the aircraft has passed the transfer point, the controller should coordinate the transfer with the downstream ATSU and then notify the flight crew of the intended delay using CPDLC free text **UM 169** EXPECT CPDLC TRANSFER AT [time/position] or equivalent voice phraseology.

Note.— A termination request message is used to terminate a CPDLC connection (**paragraph 2.2.4.4** refers). The controller may also initiate CPDLC termination via voice communication with the flight crew.

4.2.4.2 The transferring ATSU should avoid terminating any CPDLC connection with open dialogues. In cases where it is necessary, then prior to terminating the CPDLC connection, the transferring ATSU should either:

- a) Advise the flight crew using CPDLC free text **UM 169** CHECK AND RESPOND TO OPEN CPDLC MESSAGES or equivalent voice phraseology; or
- b) Coordinate with the receiving ATSU, as necessary, any CPDLC messages that were still open after terminating the CPDLC connection.

Note.— Upon termination of the CPDLC connection, the open uplink CPDLC messages are technically closed at the transferring ATSU and the aircraft.

4.2.4.3 Before terminating the CPDLC connection, the transferring ATSU should respond to open CPDLC downlink messages.

Note.— For an ATN B1 ground or aircraft system, an open downlink message is closed upon receipt of the uplink response **UM 0 UNABLE** or **UM 237 REQUEST AGAIN WITH NEXT UNIT**.

4.2.4.4 If the controller receives an indication that the CPDLC termination was unsuccessful, the controller may attempt to resend the termination request message. If the termination is still unsuccessful, the controller should instruct the flight crew to terminate the CPDLC connection and initiate a logon to the next unit. The controller should use the CPDLC free text **UM 169am** or **UM 183am** AUTOMATIC TRANSFER OF CPDLC FAILED. WHEN ENTERING [unit name] AREA DISCONNECT CPDLC THEN LOGON TO [facility designation] or equivalent voice phraseology.

Note 1.— The [unit name] is expressed as the radiotelephony name, not the 4-character code. The [facility designation] is the four character ICAO code.

Note 2.— Instructing the flight crew to DISCONNECT CPDLC will result in loss of CPDLC connectivity. This procedure should only be applied approaching the boundary with the next ATSU.

4.2.5 CPDLC connection with aircraft transiting small data link area

4.2.5.1 Unless otherwise agreed in inter-facility agreements, the current ATSU should complete the process for establishing a CPDLC connection and for communication transfer to the next ATSU, even though the transit time through the current airspace and/or the next airspace may be very short.

Note.— CPDLC connection transfer failures can be caused by controllers or systems not completing the establishment of a CPDLC connection and/or the connection transfer during a short transit time through an ATSU's airspace.

4.2.5.2 As a consequence, even though the short transit period through an ATSU's airspace is not adequate to complete the communication transfer before the aircraft leaves the airspace, the current ATSU should ensure that all messages are sent in the proper sequence at the correct time to successfully establish a CPDLC connection and transfer the connection to the next ATSU (e.g. NDA, address forwarding, MONITOR/CONTACT, and termination request message) and manually intervene, if necessary.

Note 1.— The transferring ATSU will need to be the CDA before any of these messages can be sent successfully. For example, if the transferring ATSU tries to send the NDA message prior to becoming the CDA to account for a short transit time, the aircraft system will reject the NDA. As a result, the communication transfer may not be completed until the aircraft has traveled a significant distance into the receiving ATSU's airspace.

Note 2.— In areas where short-term transfers are common, facilities may establish agreements, per [paragraph 3.1.4.9](#), to facilitate improved connection transfers. In some instances, an advantage may be gained by skipping the CPDLC connection to an ATSU (ATSU 2 in the [Figure 4-2](#)) where a short transit occurs and transferring the NDA to the next downstream ATSU (ATSU 3)

4.2.5.3 As shown in [Figure 4-2](#), if ATSU 2 requires ADS contracts to monitor the transit of the aircraft across its area of responsibility, but the transfer of communications is not required, then ATSU 1 should send the NDA message specifying ATSU 3 as the NDA. In this case, a system with manual capability should perform address forwarding to ATSU 3 first and then to ATSU 2 to give ATSU 3 a higher priority ADS-C connection.

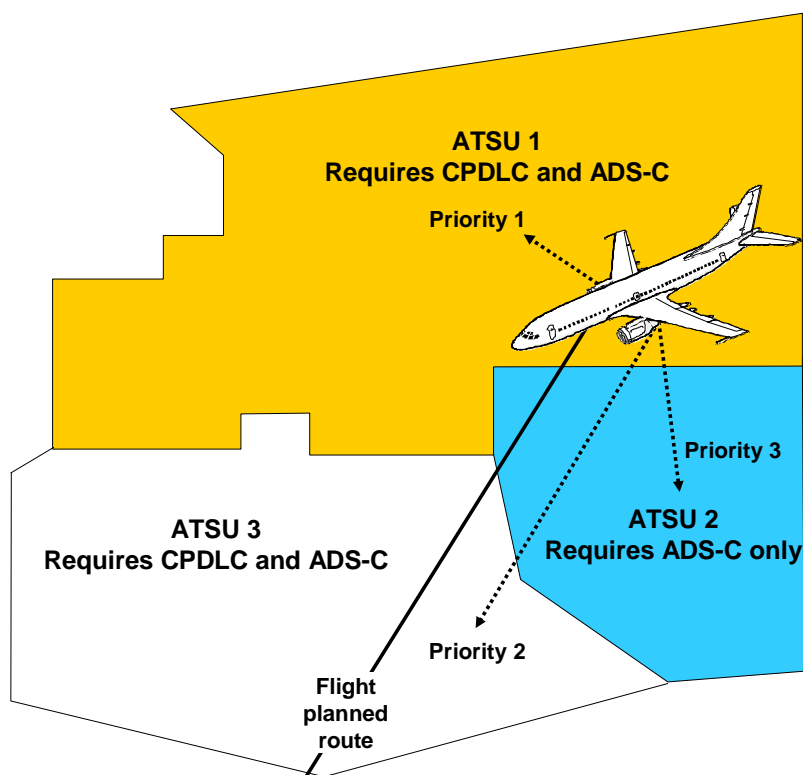

Figure 4-2. Transiting small data link area

4.2.5.4 When the CPDLC connection is transferred from ATSU 1 to ATSU 3, these ATSUs should agree on the location or time the connection transfer is to occur.

4.2.5.5 In this circumstance, ATSU 1 may inform the flight crew by CPDLC free text UM 169m (or voice equivalent): EXPECT NEXT CENTER [facility designation]. CONTACT WITH [facility designation] NOT REQUIRED.

Example:

Controller (free text)	<u>UM 169m</u> EXPECT NEXT CENTER ATSU 3. CONTACT WITH ATSU 2 NOT REQUIRED
---------------------------	--

4.2.5.6 When applying this procedure for transferring CPDLC from ATSU 1 to ATSU 3, if the interfacility agreement requires voice to also be transferred to ATSU 3, then ATSU 1 should specify ATSU 3 in the CONTACT or MONITOR message prior to ending the CPDLC connection or alternatively use voice. However, it may be advantageous to transfer voice communications to ATSU 2 even though ATSU 2 will not need a CPDLC connection. To achieve this, ATSU 1 may specify ATSU 2 in the CONTACT/MONITOR message sent prior to ending the CPDLC connection or alternatively use voice.

4.2.5.7 If address forwarding can be manually initiated, then ATSU 1 (priority 1) should initiate address forwarding to ATSU 3 (priority 2) prior to initiating address forwarding to ATSU 2 (priority 3). A system that performs automatic address forwarding would normally perform the address forwarding in sequence (i.e. ATSU 2 first and then ATSU 3).

Note.— *The order in which the ATSU 1 performs address forwarding will ensure that the limited number of ADS-C connections available are used in the priority assigned to each ATSU.*

4.3 CPDLC – Uplink messages

4.3.1 General

4.3.1.1 If an unexpected or inappropriate response to a CPDLC uplink message is received or there is any misunderstanding or doubt about the intent of a CPDLC dialogue, the controller should initiate voice contact to clarify the meaning or intent. (see [Appendix A](#) for intent and use of CPDLC uplink and downlink message elements).

4.3.1.2 When a closure response to an open CPDLC uplink message is not received within a reasonable time period as determined by the ATSU, the controller should:

- a) Continue to protect any airspace reserved by an outstanding clearance until an appropriate operational response is received from the flight crew;
- b) For a FANS 1/A ATSU, send CPDLC free text [UM 169j](#) CHECK AND RESPOND TO OPEN CPDLC MESSAGES, rather than re-sending the original message. Alternatively, the controller may use voice communication to clarify the status of the open CPDLC uplink message; or
- c) For an ATN-B1 ATSU or a FANS 1/A-ATN B1 ATSU providing services to a FANS 1/A aircraft, use voice communication to resolve the operational situation resulting from the timed out CPDLC uplink message.

Note 1.— *A closure response is a response that operationally closes the dialogue. A [DM 2 STANDBY](#) response to an open CPDLC uplink message does not operationally close the dialogue.*

Note 2.— *The use of a CPDLC free text message by a FANS 1/A ATSU avoids multiple open messages involving the same instruction.*

Note 3.— *An ATN B1 aircraft system and ground system close the uplink message after the aircraft timer (ttr) expiration and receipt of an ERROR response. In normal circumstances, the aircraft-timer (ttr) expires before the ground-timer (tts) expires.*

Note 4.— *Some FANS 1/A-ATN B1 ATSUs automatically initiate a Provider Abort (commanded termination) message to the aircraft upon expiration of the ground timer (tts).*

4.3.1.3 The controller should only use standard message elements when composing clearances or instructions. However, circumstances may exist where the controller may use free text to supplement the standard message elements (See [paragraph 4.3.2](#)).

Note.— *The use of standard message elements will minimize the risk of input errors and misunderstandings, and facilitate use by a non-native English speaking controllers and flight crews. The use of standard message elements allows the aircraft and ground systems to automatically process the information in the messages that are exchanged, which allows the flight crew to respond more quickly to*

a standard clearance. For example, the ground system can be capable of automatically updating flight plan data for route conformance monitoring, the aircraft system can be capable of allowing the flight crew to load clearance information into the FMS with a LOAD prompt and review the clearance, and both aircraft and ground systems can associate responses to messages.

4.3.2 Use of free text

4.3.2.1 The controller should avoid the use of the free text message element. However, its use may offer a viable solution to enhance operational capability.

Note.— See [paragraph 3.1.1.4](#) for guidelines for the ANSP to validate the use of the free text message element.

4.3.2.2 The controller should only use a free text message when an appropriate standard message element does not exist and the intended use does not change the volume of protected airspace.

4.3.2.3 When free text is used, the controller should use standard ATS phraseology and format and avoid nonessential words and phrases. The controller should only include abbreviations in free text messages when they form part of standard ICAO phraseology, for example, ETA.

4.3.3 “EXPECT” uplink messages

4.3.3.1 The controller should only use the EXPECT message elements:

- a) When responding to a flight crew request using the appropriate message element provided in [Table 4-2](#); or
- b) When procedurally required to advise the flight crew using the appropriate message element provided in [Table 4-3](#).

Note.— The FANS I/A CPDLC message set contains EXPECT uplink message elements that the controller should NOT use because of potential misinterpretation in the event of a total communication failure. Some of these message elements have been reserved by Doc 4444. See [Appendix A, paragraph A.3](#), and [Appendix E, paragraph E.7.1.3](#), for specific uplink message elements that should not be used.

Table 4-2. “EXPECT” uplink message elements for flight crew requests

Ref DL	Request message Element	Ref UL	Response message element
			“EXPECT” Vertical Clearances
DM 53	WHEN CAN WE EXPECT HIGHER LEVEL or <i>WHEN CAN WE EXPECT HIGHER ALTITUDE</i>	UM 7	EXPECT CLIMB AT [time]
		UM 8	EXPECT CLIMB AT [position]
DM 52	WHEN CAN WE EXPECT LOWER LEVEL or <i>WHEN CAN WE EXPECT LOWER ALTITUDE</i>	UM 9	EXPECT DESCENT AT [time]
		UM 10	EXPECT DESCENT AT [position]

Ref DL	Request message Element	Ref UL	Response message element
			“EXPECT” Lateral Offsets
<u>DM 51</u>	WHEN CAN WE EXPECT BACK ON ROUTE	<u>UM 70</u>	EXPECT BACK ON ROUTE BY [position]
		<u>UM 71</u>	EXPECT BACK ON ROUTE BY [time]
			“EXPECT” Speed Changes
<u>DM 49</u>	WHEN CAN WE EXPECT [speed]	<u>UM 100</u>	AT [time] EXPECT [speed]
		<u>UM 101</u>	AT [position] EXPECT [speed]

Table 4-3. Procedural “EXPECT” uplink message elements

Ref UL	Intent	Advisory message element
		“EXPECT” Route Modifications
<u>UM 93</u>	Notification that an onwards clearance may be issued at the specified time.	EXPECT FURTHER CLEARANCE AT [time]
<u>UM 99</u>	Notification that a clearance may be issued for the aircraft to fly the specified procedure.	EXPECT [procedure name]
		“EXPECT” Air Traffic Advisories
<u>UM 169k</u>	Notification that a SELCAL check on the specified HF frequency should be expected.	EXPECT SELCAL CHECK HF [frequency]
<u>UM 169l</u>	Notification that the CPDLC transfer process will not be completed at the boundary and will be delayed until the specified time or position. If the CPDLC transfer is not completed by the specified time or position, the flight crew should manually disconnect CPDLC and initiate a logon to the next center.	EXPECT CPDLC TRANSFER AT [time/position]
<u>UM 169m</u>	Notification that a CPDLC connection is not required by the next ATSU (e.g. due to short transition time through the next ATSU’s airspace) and CPDLC connection will be transferred to the subsequent ATSU.	EXPECT NEXT CENTER [facility designation]. CONTACT WITH [facility designation] NOT REQUIRED
<u>UM 169p</u>	Notification that a previously issued speed can be expected to be maintained until the specified position or time.	EXPECT TO MAINTAIN [speed] UNTIL [time / position]

4.3.4 Vertical clearances

4.3.4.1 When a vertical clearance contains a constraint for starting the climb or descent, the controller should precede the conditional vertical clearance with **UM 19** MAINTAIN [level]:

Controller	UM 19 MAINTAIN [level] UM 21 AT [time] CLIMB TO [level] or AT [time] CLIMB TO AND MAINTAIN [altitude]
Controller	UM 19 MAINTAIN [level] UM 22 AT [position] CLIMB TO [level] or AT [position] CLIMB TO AND MAINTAIN [altitude]
Controller	UM 19 MAINTAIN [level] UM 24 AT [time] DESCEND TO [level] or AT [time] DESCEND TO AND MAINTAIN [altitude]
Controller	UM 19 MAINTAIN [level] UM 25 AT [position] DESCEND TO [level] or AT [position] DESCEND TO AND MAINTAIN [altitude]

Note 1.— Conditional clearances add to the operational efficiency of the airspace. Conditional clearances, however, have been associated with a large number of operational errors. Conditional clearances are therefore used only when necessary.

*Note 2.— The potential exists for the AT [time/position] constraint at the beginning of a conditional vertical clearance to be missed by the flight crew and consequently the clearance may be executed prematurely. Including the **UM 19** MAINTAIN [level] message element indicates to the flight crew that the current level/altitude is to be maintained until the specified condition has been satisfied and may prevent such clearances being executed prematurely.*

Note 3.— For ATN-B1 systems, these vertical clearance message elements are not available.

4.3.4.2 When a vertical clearance contains a constraint that is applicable during the flight maneuver, the controller may use a conditional vertical clearance, as provided in **Table 4-4**, as either:

- A single-element message, when the conditional vertical clearance is independent; or
- A multi-element message, when another vertical clearance is dependent on the conditional vertical clearance (see also [paragraph 4.3.6](#)).

Table 4-4. Conditional vertical clearances applicable during flight maneuver

Ref #	Message element
UM 26	CLIMB TO REACH [level] BY [time]
UM 27	CLIMB TO REACH [level] BY [position]
UM 28	DESCEND TO REACH [level] BY [time]
UM 29	DESCEND TO REACH [level] BY [position]
UM 171	CLIMB AT [vertical rate] MINIMUM
UM 172	CLIMB AT [vertical rate] MAXIMUM

Ref #	Message element
UM 173	DESCEND AT [vertical rate] MINIMUM
UM 174	DESCEND AT [vertical rate] MAXIMUM

Example 1: The controller issues a vertical clearance for the aircraft to climb to FL 390 and maintain FL 390 AT or BEFORE 2200Z.

Controller	UM 26 CLIMB TO REACH FL390 BY 2200Z

Example 2: The controller issues a vertical clearance for the aircraft to climb to FL 390 at a vertical rate of 2000 feet per minute (or greater).

Controller	UM 20 CLIMB TO FL390 or <i>CLIMB TO AND MAINTAIN FL390</i> UM 171 CLIMB AT 2000 FEET PER MINUTE MINIMUM UM 129 REPORT MAINTAINING FL390 or <i>REPORT LEVEL FL390</i>

Example 3: The controller issues a vertical clearance for the aircraft to climb to FL 390, and reach an intermediate level of FL 370 (or higher) AT or BEFORE 0100Z.

Controller	UM 20 CLIMB TO FL390 or <i>CLIMB TO AND MAINTAIN FL390</i> UM 26 CLIMB TO REACH FL370 BY 0100Z UM 129 REPORT MAINTAINING FL390 or <i>REPORT LEVEL FL390</i>

Note.— A more appropriate procedure would be for the controller to use the message element [UM 192](#) REACH [level] BY [time], defined in ICAO Doc 4444. However, this message element is not available in the FANS I/A message set. The example uses the message element [UM 129](#) **REPORT MAINTAINING [level]** or *REPORT LEVEL [altitude]* to highlight the final level intended by the clearance.

4.3.4.3 If a level restriction is required after sending the initial clearance, the controller should resend the entire clearance with the level restriction in a single CPDLC message.

Note.— The controller should not send a vertical clearance in a CPDLC message and then subsequently send a related level restriction in a separate message. If the controller sends the vertical clearance and the related level restriction in two separate CPDLC messages, the controller would be unintentionally amending the final cleared level of the aircraft (to FL 370) with the level restriction. The flight crew may misinterpret the two separate instructions.

4.3.4.4 If a CPDLC level report is needed, the controller should append [UM 129](#) **REPORT MAINTAINING [level]** or *REPORT LEVEL [altitude]* to the vertical clearance message element that is used to assign a single level/altitude.

Note 1.— When [UM 129](#) **REPORT MAINTAINING [level]** or *REPORT LEVEL [altitude]* is appended, the flight crew has access to the standard message element [UM 19](#) **MAINTAINING [level]** or

LEVEL [altitude]. If the report request is not appended, the flight crew may not report when maintaining the cleared flight level.

Note 2.— Some States do not request a CPDLC level report when using ADS-C.

*Note 3.— The controller should not use **UM 175 REPORT REACHING [level]**. ICAO Doc 4444 has reserved this message element. The programmed intent of this message element was to request a report if the aircraft occupies the specified level, which occurs as the aircraft is about to level at the specified level, but also occurs if the aircraft passes through the specified level during a climb or descent. To obtain a report at an intermediate level, use **UM 128 REPORT LEAVING [level]**.*

Example: The controller issues a conditional clearance to a flight currently cruising at FL310 requesting climb to FL350 when the climb can not be executed until the aircraft is at MICKY. The controller appends a request for a report when level at FL350.

Controller	UM 19 MAINTAIN FL310 UM 25 AT MICKY CLIMB TO FL350 or AT MICKY CLIMB TO AND MAINTAIN FL350 UM 129 REPORT MAINTAINING FL350 or REPORT LEVEL FL350
------------	---

4.3.4.5 To cancel a previously issued vertical range (i.e. block level) clearance and limit the aircraft to one specific level, the controller should issue an appropriate vertical clearance.

Example 1:

Controller	UM 19 MAINTAIN FL390 UM 129 REPORT MAINTAINING FL390 or REPORT LEVEL FL390
Flight crew	DM 0 WILCO

Example 2:

Controller	UM 20 CLIMB TO FL390 or CLIMB TO AND MAINTAIN FL390 UM 129 REPORT MAINTAINING FL390 or REPORT LEVEL FL390
Flight crew	DM 0 WILCO

*Note.— The **DM 0** WILCO response to the vertical clearance uplink cancels any previously issued vertical range clearance.*

4.3.5 Report/confirmation requests

Note.— For ATN-BI systems, report/confirmation request message elements are not available, except as indicated in [Appendix A](#).

4.3.5.1 If the controller requests the aircraft's Mach number or indicated airspeed, then the controller should use the standard message element **UM 134** (or **UM 169b**) **REPORT [speed type] [speed type] SPEED** or *CONFIRM SPEED*.

Note.— Use of standard message elements allows the flight crew to use an automated response.

4.3.5.2 If ADS-C indicates a deviation from cleared route, level or assigned speed, the controller may query the flight crew via CPDLC per [Table 4-5](#).

Table 4-5. ADS-C out-of-conformance messages

	Message element
UM 169f	ADS-C INDICATES OFF ROUTE. ADVISE INTENTIONS.
UM 169t	ADS-C INDICATES LEVEL DEVIATION. ADVISE INTENTIONS.
UM 169v	ADS-C INDICATES SPEED DEVIATION. ADVISE INTENTIONS.

4.3.5.3 If a scheduled CPDLC position report is not received, the controller may request the report by uplinking message **UM 147** REQUEST POSITION REPORT.

4.3.6 Creating multi-element uplink messages

4.3.6.1 The controller should minimize the use of CPDLC multi-element uplink messages and keep message size to a minimum.

4.3.6.2 The controller should only combine clearance or instruction message elements that are dependent on each other into a single uplink message.

Note.— *The flight crew can only respond to the entire message with a single response and would have to respond **DM 1** UNABLE if they cannot comply with any part of the message. In addition, an aircraft system may present long multi-element messages on multiple screens or pages, which increases the complexity for the flight crew in reading and understanding the message in the correct sequence prior to responding (paragraph 5.3.1 refers).*

Example 1: The controller sends a single multi-element uplink message containing message elements for each of the different parts of the clearance and/or instruction.

Controller	UM 164 WHEN READY or UM 177 AT PILOTS DISCRETION UM 23 DESCEND TO FL280 or DESCEND TO AND MAINTAIN FL280 UM 129 REPORT MAINTAINING FL280 or REPORT LEVEL FL280
------------	--

Example 2: The controller sends a single multi-element uplink message containing message elements for each of the different parts of the clearance and/or instruction.

Controller	UM 23 DESCEND TO FL280 or DESCEND TO AND MAINTAIN FL280 UM 48 CROSS DAFFY AT OR ABOVE FL310
------------	--

Note 1.— *The flight crew may misinterpret messages that contain unrelated clearances or instructions.*

Note 2.— *The controller should not send two independent clearances in a single message because the flight crew cannot individually respond to each clearance, if necessary (e.g. WILCO one clearance and UNABLE the other). The following is not recommended:*

Controller	CLIMB TO AND MAINTAIN FL350 INCREASE SPEED TO .84
------------	--

4.3.6.3 The controller should send all elements of a dependent clearance in a single unambiguous uplink message.

Example 1: Level FL330 is only available for a flight if the speed is adjusted with other flights in the same route to Mach .80 minimum, so the controller can only clear the aircraft to climb FL330 if its speed is Mach .80 or more. Both clearances are mutually dependent. If the aircraft is unable to climb then a speed adjustment is not required. If the aircraft cannot meet the speed constraint then a climb clearance is not available.

Controller	UM 108 MAINTAIN M.80 OR GREATER UM 20 CLIMB TO FL330 or <i>CLIMB TO AND MAINTAIN FL330</i>
------------	--

Note 1.— A dependent clearance is a message consisting of more than one clearance element, where the flight crew is required to comply with each of the elements. A rejection of any of the elements, either singly or in combination, renders the entire clearance invalid.

Note 2.— Sending the elements as individual messages may compromise safety or separation if the flight crew accepts the first uplink of a dependent clearance, complies with the instruction, and then responds **DM 1** UNABLE to the next message when received.

Note 3.— The flight crew will respond to the multi-element uplink message with either **DM 0** WILCO or **DM 1** UNABLE, which applies to the entire message, per [paragraph 5.3.1.2](#).

Note 4.— The controller should not send a dependent clearance in a single multi-element uplink message containing the condition THEN. In the following example, the message element **UM 165** THEN followed by the route clearance message element **UM 74** PROCEED DIRECT TO [position] does not clearly convey that the flight crew needs to complete the climb clearance prior to commencing the route clearance change.

Controller	CLIMB TO AND MAINTAIN FL330 THEN PROCEED DIRECT TO TUNTO
------------	---

Example 2: The controller sends a single multi-element uplink message containing an amended route clearance that is dependent on a vertical clearance. To eliminate any potential ambiguity, the controller chose the second element to reinforce that the flight crew needs to comply with the vertical clearance prior to complying with the amend route clearance.

Controller	UM 20 CLIMB TO FL330 or <i>CLIMB TO AND MAINTAIN FL330</i> UM 78 AT FL330 PROCEED DIRECT TO TUNTO UM 129 REPORT MAINTAINING FL330 or <i>REPORT LEVEL FL330</i> .
------------	---

4.3.7 Weather deviations

Note.— For an ATN-B1 ATSU, message elements supporting weather deviations are not available.

4.3.7.1 When issuing a deviation clearance, the controller should use **UM 82** CLEARED TO DEVIATE UP TO [specified distance] [direction] OF ROUTE and append **UM 127** REPORT BACK ON ROUTE.

Note.— If a clearance direct to a waypoint is issued before the deviating aircraft has reported back on route, the controller will need to determine the aircraft's location or continue to protect the airspace affected by the weather deviation clearance until the aircraft sequences the specified waypoint.

4.3.7.2 A weather deviation clearance remains in effect until either:

- a) A “back on route” report is received; or
- b) The aircraft reaches a subsequent waypoint to which it has been cleared when clear of weather.

4.4 CPDLC – Downlinks

4.4.1 General

4.4.1.1 The ATSU should respond to a downlink message that it does not support according to **paragraph 3.1.2.5.3**.

4.4.1.2 The ATSU should respond to an incoming request as soon as practicable to avoid the flight crew initiating a duplicate request.

Note.— ATN B1 ground systems provide for automatic timeout of messages that are not responded to, while FANS I/A ground system messages can remain open indefinitely.

4.4.2 Clarifying a downlink message

4.4.2.1 In the case of a controller having any doubt as to the intent of a downlink message, or if any other ambiguity exists, the controller should seek clarification using CPDLC or voice. The controller should then respond to the downlink message with a CPDLC message consistent with the clarification to prevent confusion and to close the open downlink message.

4.4.3 Responses/acknowledgements

4.4.3.1 The controller should respond to a clearance request by issuing a clearance using an appropriate standard message element, **UM 1** STANDBY or **UM 0** UNABLE.

4.4.3.2 When a clearance request is denied, the controller should send **UM 0** UNABLE and, when practicable, append a reason for the non-availability of the clearance.

Note.— The controller should not restate the aircraft's current clearance.

4.4.3.3 The controller should send **UM 1** STANDBY to provide advice to the flight crew that the requested clearance is being assessed, but is not readily available, for example, due to traffic or delays in coordination with the next sector or ATSU.

Note 1.— Some ATSU_s automatically send a **UM 1** STANDBY to acknowledge that it received a downlink request (refer to [Appendix E](#)).

Note 2.— Some FANS 1/A aircraft may reject the actual response after having received a preliminary **UM 1** STANDBY for the downlink request (refer to [Appendix F, paragraph F.24](#)).

4.4.3.4 If a **UM 1** STANDBY response is sent, the controller should subsequently send another response within a reasonable period of time, or as required to prevent message timeout or flight crew confusion.

Note.— The downlink message remains open. If the controller does not respond within this time, the flight crew may query the controller per [paragraph 5.4.1.5](#).

4.4.3.5 If a duplicate CPDLC request is received prior to having responded to the first request, the controller should send appropriate responses to both of the requests.

Note.— Responding to both requests will close the downlink messages. Depending on the ground system, the closure response for the second request may be:

a) a re-iteration of the response for the first downlink request (e.g. a clearance or **UM 0** UNABLE);
or

b) some other uplink message that does not contradict any previous clearance that may have been sent (i.e. avoid sending a clearance to one downlink request and **UM 0** UNABLE to the duplicated downlink message)

Example 1:

	Dialogue 1	Dialogue 2
Flight crew	DM 9 REQUEST CLIMB TO FL370	
Flight crew		DM 9 REQUEST CLIMB TO FL370
Controller	UM 0 UNABLE	
Controller		UM 0 UNABLE

Example 2:

	Dialogue 1	Dialogue 2
Flight crew	DM 9 REQUEST CLIMB TO FL370	
Flight crew		DM 9 REQUEST CLIMB TO FL370
Controller	UM 20 CLIMB TO FL370 or CLIMB TO AND MAINTAIN FL370	
Controller		UM 20 CLIMB TO FL370 or CLIMB TO AND MAINTAIN FL370; or (for example) UM 169 CLEARANCE ALREADY SENT
Flight crew	DM 0 WILCO	
Flight crew		DM 0 WILCO or DM 3 ROGER, as appropriate

4.4.3.6 If a **UM 1** STANDBY message had previously been sent when a duplicated request is received, and additional time is required before the clearance is available, the controller should respond with **UM 2** REQUEST DEFERRED, when appropriate.

Example:

	Dialogue 1	Dialogue 2
Flight crew	DM 9 REQUEST CLIMB TO FL370	
Controller	UM 1 STANDBY	
Flight crew		DM 9 REQUEST CLIMB TO FL370
Controller		UM 2 REQUEST DEFERRED
Time passes until clearance is available.		
Controller	UM 20 CLIMB TO FL370 or <i>CLIMB TO AND MAINTAIN FL370</i>	
Controller		UM 20 CLIMB TO FL370 or <i>CLIMB TO AND MAINTAIN FL370</i> ; or (for example) UM 169 CLEARANCE ALREADY SENT
Flight crew	DM 0 WILCO	
Flight crew		DM 0 WILCO

4.4.4 Responding to multi-element requests

4.4.4.1 While it is recommended that the flight crew avoid requests for multiple clearances in a single CPDLC message per [paragraph 5.4.1.4](#), such requests can occur.

4.4.4.2 If the controller receives multiple clearance requests in a single message and can approve all clearance requests, the controller should respond in a single message that includes the appropriate clearance for each request in the message.

Example:

Flight crew	DM 9 REQUEST CLIMB TO FL370 DM 22 REQUEST DIRECT TO TUNTO
Controller	UM 20 CLIMB TO FL370 or <i>CLIMB TO AND MAINTAIN FL370</i> UM 74 PROCEED DIRECT TO TUNTO

4.4.4.3 If the controller receives multiple clearance requests in a single message and cannot approve all of the clearance request elements, the controller should send, in a single message, **UM 0** UNABLE, which applies to all elements of the original message.

Note 1.— The controller should not restate the aircraft's current clearance.

Note 2.— The controller should not send a single message containing **UM 0 UNABLE** for elements of the multiple clearance request that cannot be granted and a clearance for the remaining elements.

Note 3.— The controller may include a reason to remove any ambiguity and, if appropriate, information on when the portions of the clearance request that are available might be expected.

Note 4.— The controller may, following the **UM 0 UNABLE** [reason] message, send a separate CPDLC message (or messages) to respond to those elements for which they can issue an appropriate clearance.

Example 1:

Flight crew	DM 9 REQUEST CLIMB TO FL370 DM 22 REQUEST DIRECT TO TUNTO
Controller	UM 0 UNABLE

Example 2:

Flight crew	DM 9 REQUEST CLIMB TO FL370 DM 22 REQUEST DIRECT TO TUNTO
Controller (provide reason using standard message element)	UM 0 UNABLE UM 166 DUE TO TRAFFIC
Controller (separate message element)	UM 74 PROCEED DIRECT TO TUNTO

4.4.5 Offering alternative clearances to requests

4.4.5.1 If a clearance request contained in a CPDLC message cannot be issued, the controller should send **UM 0 UNABLE** to deny the request prior to issuing any subsequent clearances.

a) If an alternative clearance (intermediate level or deferred climb) can be issued, the controller may subsequently uplink the clearance in a separate CPDLC message; and

b) If an alternative clearance that the flight crew might not be able to accept (higher level or route modification) can be issued, the controller should negotiate the clearance with the flight crew prior to issuing it.

Note.— The procedures for issuing alternative clearances are not applicable to a clearance request associated with an ADS-B ITP. See [paragraph 6.3](#).

Example 1: The aircraft is maintaining FL330. The controller is unable to issue the requested clearance and issues an alternative clearance to a flight level that is lower than requested.

Flight crew	DM 9 REQUEST CLIMB TO FL370
Controller	UM 0 UNABLE

	UM 166 DUE TO TRAFFIC
Controller	UM 20 CLIMB TO FL350. UM 129 REPORT MAINTAINING FL350 or UM 20 CLIMB TO AND MAINTAIN FL350. UM 129 REPORT LEVEL FL350

Example 2. The aircraft is maintaining FL330. The controller is unable to issue the requested clearance, and queries whether the aircraft can accept a flight level that is higher than requested.

Flight crew	DM 9 REQUEST CLIMB TO FL370
Controller	UM 0 UNABLE UM 166 DUE TO TRAFFIC
Controller	UM 148 WHEN CAN YOU ACCEPT FL390
Flight crew	DM 81 WE CAN ACCEPT FL390 AT 2200

Note.— The controller should not simply respond to the downlink request with the alternative clearance. The following procedure is not a recommended practice. The controller does not provide the correct ATC response.

Flight crew	REQUEST CLIMB TO FL370
Controller	UNABLE. CLIMB TO FL350. REPORT MAINTAINING FL350 or UNABLE. CLIMB TO AND MAINTAIN FL350. REPORT LEVEL FL350

4.5 ADS-C

Note.— For ATN B1, the ADS-C application is not supported.

4.5.1 General

4.5.1.1 ADS-C reports contain FMS information relating to the figure of merit (FOM), ACAS and the aircraft's navigational redundancy. Some automated ground systems use the FOM value received in an ADS-C report to determine whether to display the report to controllers, or to display a "high" or "low" quality ADS-C symbol.

4.5.1.2 If a FOM-reported navigational performance is being used and a change to the FOM value is observed, the controller should seek clarification from the flight crew as to the extent of any observed navigational degradation.

Note.— In accordance with ICAO Doc 4444, paragraph 5.2.2, the flight crew advises ATC of degraded performance below the level required for the airspace and where the reported degradation affects the separation minimum currently being applied, the controller would take action to establish another appropriate type of separation.

4.5.1.3 If a flight crew inserts a non-ATC waypoint into the aircraft active flight plan, the aircraft may send a waypoint change event report, which contains information on the non-ATC waypoint in the predicted route group, as well as the intermediate and fixed projected intent groups of the report. The

ATSU may receive information on the next, or the next-plus-one waypoints from that report that do not correlate with the waypoint information provided in the current flight plan or flight data record held by the ATSU. Refer to [Appendix F, paragraph F.5](#) for FMS processing of waypoints on different aircraft types.

Note.— *The flight crew normally would not insert non-ATC waypoints per [paragraph 5.6.4.4](#).*

4.5.1.4 Unless required for safety purposes, such as to monitor aircraft operating close to, but not entering its airspace, the ATSU should only establish ADS contracts for aircraft within its area of responsibility.

4.5.1.5 A controller who becomes aware of corrupt or incorrect data from an ADS-C report should establish voice contact with the aircraft concerned in order to correct the situation.

4.5.1.6 When an ATSU is using both ADS-C and CPDLC position reporting and detects a discrepancy of 2 minutes or less between the reports, the controller should reconcile the time difference. Where the time difference is more than 2 minutes, the controller should request confirmation of the estimate for the waypoint in question.

Note.— *CPDLC and ADS-C estimates received from the same aircraft for the same position may differ as a result of the ADS-C application reporting time to the second and the time reported by CPDLC application either being truncated or rounded to the nearest full minute (depending on aircraft type). The flight crew also has the ability to modify the estimate for the next position in the CPDLC position report. Any such modification will not be reflected in the ADS-C report.*

4.5.1.7 Whenever an ADS-C report (either a periodic or waypoint change event report) is not received within a parameter of the expected time, the controller should ascertain the position of the aircraft by initiating a demand contract request, re-establish a new periodic contract with the aircraft, or request a CPDLC or voice position report.

4.5.1.8 When the application of specified separation minima is dependent on the reporting interval of periodic position reports, the ATC unit should only establish a periodic contract with a reporting interval less than the required reporting interval.

4.5.1.9 If the controller becomes aware of a data link communications failure, the controller should advise affected aircraft to revert to voice position reporting in accordance with [paragraph 4.9.3](#).

4.5.2 ADS contracts

4.5.2.1 In airspace where procedural separation is being applied, the ATSU should establish the following:

- a) ADS periodic contract at an interval appropriate to the airspace requirements; and
- b) ADS event contract for the following events:
 - 1) Waypoint change event;
 - 2) Lateral deviation event;
 - 3) Level range deviation event; and
 - 4) Vertical rate change event of negative 5000 feet per minute (descent rate).

4.5.3 ADS-C connection management

4.5.3.1 The ATSU should terminate ADS contracts when they are no longer operationally required.

4.5.3.2 When the ATS ground system receives a logon request message, the ATSU may initiate an ADS-C connection by sending an ADS contract request(s) to the aircraft. The ADS-C application does not assign any technical priority to ADS-C connections; therefore, the controlling ATSU may not be aware of other connections established with the aircraft. As a result, when the ground system functionality permits it, and where circumstances make it advantageous, the controlling ATSU should initiate address forwarding in an order that would provide ATSUs that will control the aircraft with an opportunity to have the highest priority for ADS-C connections.

Note 1.— ADS-C reports are assembled and sent in a sequential process based on the order of the ADS contracts established with the various ATSUs. For example, the first ATSU to establish contracts with the aircraft will continue to receive the reports from the aircraft first, even if it no longer has control of the flight. When this connection is terminated, the next ATSU to have established ADS contracts begins to receive the reports first. This may have the effect of reducing the apparent ADS-C performance of aircraft for which the ATSU is not the first unit to be receiving the ADS-C report.

Note 2.— The following guidance is for ground systems that allow the controller to manually initiate the address forwarding process. Other systems have automated this process, often linking it to the automated coordination of the aircraft. Those systems will normally forward aircraft in the order in which they need to be coordinated.

4.5.3.3 The order for address forwarding should be as follows:

- a) The NDA;
- b) An ATSU requiring an ADS-C connection for close boundary monitoring; and
- c) Other miscellaneous connections.

Note 1.— The NDA may not be the next ATSU on route in the situation where there is a short sector transition and the next ATSU has advised that it wants to assume NDA.

4.5.3.4 For example, as shown in [Figure 4-3](#), an ADS contract is required by ATSU 2 to monitor the aircraft's progress. To ensure that the next unit with direct control responsibility for the aircraft (ATSU 3) has priority over the ADS-C connections, ATSU 1 should initiate address forwarding to ATSU 3 prior to address forwarding to ATSU 2.

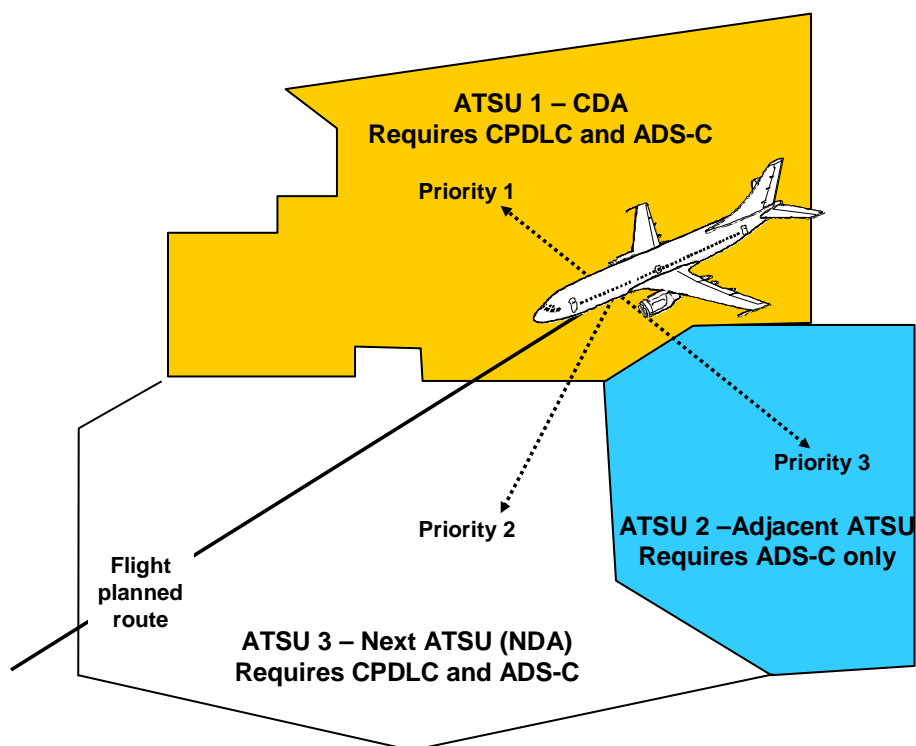

Figure 4-3. Priorities for ADS-C connections

4.5.3.5 When all available ADS-C connections with a particular aircraft have been established, such as shown in [Figure 4-4](#), any other ATSU attempting to connect with the aircraft will receive a DISCONNECT REQUEST (DIS) message with "reason code 1" (congestion).

4.5.3.6 When such a DIS message is received by an ATSU that would normally have priority for an ADS-C connection, the ATSU should notify the current controlling ATSU. The controlling ATSU should attempt to resolve the situation.

4.5.3.7 The controlling ATSU has a number of options available, such as coordination with the previous ATSU or other adjacent ATSUs to determine if the existing ADS-C connections are still required or, when considered absolutely necessary, instructing the flight crew to terminate ADS-C connections per [Appendix F, paragraph F.11](#).

4.5.3.8 Depending on aircraft type, the latter option may terminate all current ADS contracts; therefore, the controlling authority should consider the operational effect on other ATSUs prior to employing this method. For example, as shown in [Figure 4-4](#), the aircraft has allocated priority for ADS-C connections with four ATSUs and one AOC facility:

Connection:	1 - with ATSU 1 2 - with ATSU 2 3 - with the previous controlling ATSU 4 - with the AOC facility 5 - with a ground facility collecting test data
-------------	--

ATSU 3, the next controlling authority, is unable to establish an ADS-C connection with the aircraft due to congestion.

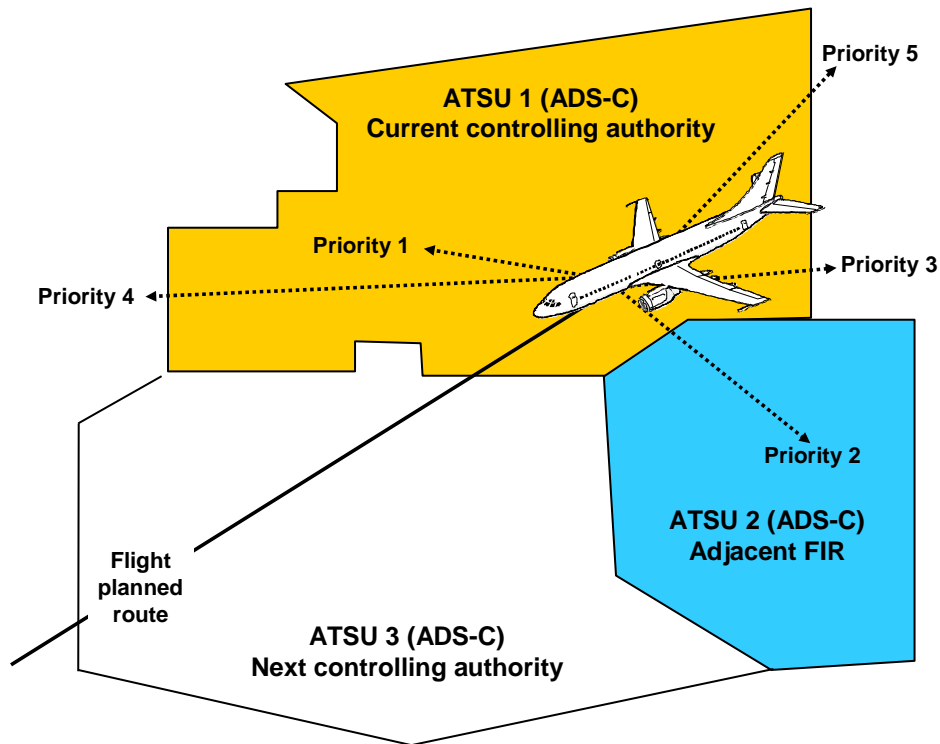

Figure 4-4. ADS-C connection not available due to congestion

4.5.4 ADS contract - periodic

4.5.4.1 When setting a default periodic reporting interval, the ANSP should take into account requirements for the separation standard in use, conformance monitoring, traffic levels, and alerting service. Typically, default periodic contract intervals are set to satisfy the position reporting requirements of the default separation standard in use.

4.5.4.2 The ANSP should avoid arbitrarily selecting short periodic default intervals because of the economic cost to the users and the unnecessary system loading imposed by these short default intervals.

4.5.4.3 There are a number of situations where a controller or ground automation may use a reporting interval other than the default interval in the periodic contract. A change to the default interval for an aircraft may be warranted or useful when:

- a) The aircraft is cleared to deviate from areas of known significant weather;
- b) The application of a smaller separation standard requires a shorter periodic interval;
- c) There are periods of turbulence;
- d) An unauthorized deviation from the clearance is detected; or
- e) The aircraft is approaching a crossing route on which there is other traffic.

4.5.4.4 The ANSP should ensure that the periodic reporting interval in use is in accordance with the position reporting requirements of the separation standard being used. In some circumstances, such as an emergency situation, the ATSU may establish a shorter periodic reporting interval. When not required for the application of separation, or other circumstances, the ANSP should return to a longer periodic reporting interval to reduce operators costs and unnecessary loading of the system.

Note.— Normally, the controlling ATSU should not establish ADS-C periodic reporting at an interval shorter than five minutes. An adjacent non-controlling ATSU should not establish ADS-C periodic reporting at an interval shorter than what is required for application of any reduced separation in effect for the flight. In unusual circumstances, the ATSU may specify a periodic reporting interval for a few aircraft as short as 64 seconds, per [paragraph 2.2.6.3.3.2](#).

4.5.5 ADS contract - waypoint change event

4.5.5.1 A waypoint event report will be sent at any waypoint contained in the aircraft active flight plan, which may include compulsory and non-compulsory reporting points. These waypoints are reflected in the predicted route group.

4.5.6 ADS contract - vertical range change and lateral deviation events

4.5.6.1 When the level range deviation event and lateral deviation event contracts are established, the controller will only be alerted to vertical or lateral variations that exceed the associated tolerances.

Note.— If a regular periodic report is sent as the aircraft is deviating from cleared level or route (but still within the level or lateral tolerances) the controller will still be alerted to the variation despite no event report having been sent.

4.6 Separation

4.6.1 General – ADS-C

4.6.1.1 The ATSU may use ADS-C for the application of procedural separation within a mixed environment, such as airspace where position reports are provided by a mixture of aircraft reporting by ADS-C and aircraft reporting by other means.

4.6.1.2 For example, the ATSU may use a combination of ADS-C, voice reports, radar or ADS-B information to determine separation between two or more aircraft.

4.6.1.3 When ADS-C is used for route conformance monitoring to support the separation, the ATSU should establish appropriate ADS contracts that specify the periodic reporting interval and tolerances on events in accordance with separation standards.

Note.— This will ensure that estimates being used for route conformance monitoring are acceptable for the separation and the controller receives an indication when the aircraft is not in conformance with its current flight plan.

4.6.1.4 The controller should advise the flight crew when the controller observes that the aircraft has deviated significantly from its cleared flight profile. The controller should take action as appropriate if the deviation is likely to affect the air traffic service being provided.

4.6.2 Vertical separation –ADS-C

4.6.2.1 Where practical, the tolerances used to determine whether a specific level is occupied by an ADS-C reporting aircraft within the airspace of a specific ATSU should be consistent with other tolerances used throughout the airspace. For example, the vertical tolerances for ADS-C should be consistent with vertical tolerances used for level adherence monitoring by other forms of surveillance, such as radar.

4.6.2.2 Where other vertical tolerances do not exist, the ATSU should apply a vertical tolerance of +/- 300 feet for ADS-C applications. However, an individual ATSU may specify in local instructions and the AIP (or other appropriate publication) that it uses a tolerance of not less than +/- 200 feet to provide consistency with other vertical tolerances applied within its airspace.

4.6.2.3 If displayed ADS-C level information does not satisfy the required tolerance for an individual ATSU, then the controller should advise the flight crew accordingly and request confirmation of the aircraft's level. If following confirmation of the level, the displayed ADS-C level information is still beyond the required tolerance, the controller may need to apply another method of separation or another method of determining level information.

4.6.2.4 When displayed ADS-C level information is within the specified tolerance of the expected or cleared flight level, the ATSU may use the ADS-C level information to apply vertical separation and to determine that an aircraft has reached or is maintaining a specified level.

4.6.2.5 The controller can consider that an aircraft has left a specified level when the displayed ADS-C level information indicates that the aircraft has passed the level in the required direction by more than the required tolerance.

4.6.3 Lateral separation – ADS-C

4.6.3.1 An ATSU can use ADS-C report information to automatically detect when an aircraft is beyond an area of lateral conflict and provide an indication when this occurs to the controller.

4.6.3.2 When conflict detection tools are not available, the controller can determine lateral conflicts by observing the ADS-C report information and determining if the aircraft is within or outside the area of conflict.

Note.— *The adequacy of the procedures used to detect lateral conflicts is a matter of the State.*

4.6.4 Longitudinal separation – ADS-C

4.6.4.1 ATSU's that use approved or integrated measurement tools for the purpose of determining screen-based separation should publish in local documentation any limitations on the use of such tools for the establishment and monitoring of separation standards.

4.6.4.2 The ATSU may use ADS-C reports to establish and monitor longitudinal time and distance separation standards.

4.6.4.3 Some ground systems display an extrapolated or interpolated ADS-C symbol between the receipt of ADS-C reports. Provided that the periodic reporting interval in use is in accordance with any maximum reporting interval specified by the separation standard, the ATSU may determine separation between the extrapolated/interpolated symbols by the use of screen-based measurement tools, or by the use of automated conflict detection tools.

4.6.4.4 When the ATSU uses extrapolated or interpolated ADS-C symbols to provide separation and any doubt exists as to the integrity or validity of the information being presented, the controller should send a demand contract to update the relevant information. If doubt still exists, the controller should consider using an alternative method of separation.

4.6.4.5 The ATSU may use ground system flight data records updated by ADS-C reports in the application of appropriate time-based separation standards. Methods of determination may include reference to:

- a) Estimates at waypoints;
- b) Calculated estimates for positions not contained in the flight plan;
- c) Screen-based measurement tools; or
- d) Automated conflict detection tools.

4.6.4.6 The ATSU may use ADS-C reports for the application of appropriate longitudinal distance standards. Methods of determination may include:

- a) The use of automated system tools to measure the displayed positions of two or more aircraft reporting by ADS-C;
- b) Comparing the displayed position of an ADS-C aircraft with the position of another aircraft determined by an alternative form of surveillance; or
- c) The use of automated conflict detection tools.

4.6.5 Using FMC WPR for position reporting

4.6.5.1 Whenever an FMC waypoint position report is overdue by more than a specific interval, as determined by ATC, the controller should take action to advise the aircraft concerned and request a voice position report. If either the flight crew or the controller notices intermittent operation, either may revert to voice reporting at any time. (The flight crew would be expected to report by voice for the remainder of the flight.)

4.6.5.2 A controller who becomes aware of corrupt or incorrect data in the FMC waypoint position report should establish voice contact with the aircraft concerned in order to correct the situation.

4.6.5.3 A controller who becomes aware of a FMC WPR service failure should advise affected aircraft to revert to voice position reporting in accordance with [paragraph 4.9.3](#).

4.7 Alerting service

4.7.1 For ADS-C aircraft, the ATSU should base the provision of the alerting service on any missed scheduled report (i.e. provided by either the periodic contract or the waypoint event contract).

4.8 Emergency procedures

4.8.1 General

4.8.1.1 The flight crew will use whatever means are appropriate (i.e. CPDLC and/or voice) to communicate during an emergency.

Note.— For ATN B1 aircraft, emergency message elements are not supported. See [Appendix A, paragraph A.4](#), for a list of emergency message elements.

4.8.1.2 When emergency situations are communicated via CPDLC, the controller may respond via CPDLC. However, the controller may also attempt to make voice contact with the aircraft.

4.8.1.3 The controller should follow normal emergency response procedures, as appropriate, depending on the nature of the emergency.

4.8.2 CPDLC and ADS-C emergency

4.8.2.1 If the ATSU receives an ADS-C emergency report without a corresponding CPDLC emergency message, then the controller should request confirmation of the emergency in accordance with the guidelines provided in [paragraph 4.8.3](#).

4.8.2.2 The controller should treat any CPDLC downlink message that contains an emergency message element (see [Appendix A, paragraph A.4](#) for the list of emergency message elements) as an emergency message.

Note 1.— For FANS 1/A, **DM 80 DEVIATING UP TO [specified distance] [direction] OF ROUTE** or **DEVIATING [distance/offset] [direction] OF ROUTE** is used in normal operations and is not an emergency message element.

Note 2.— When the ATSU receives **DM 55 PAN PAN PAN** or **DM 56 MAYDAY MAYDAY MAYDAY**, additional message elements (e.g. **DM 61 DESCENDING TO [level]**) may be appended. These additional message elements may not accurately reflect the current level/altitude, attitude, tracking information, or the intentions of the flight crew.

4.8.2.3 If the ATSU receives a CPDLC emergency message such as **DM 55 PAN PAN PAN** or **DM 56 MAYDAY MAYDAY MAYDAY**, the controller should acknowledge receipt of the CPDLC message using the most appropriate means (voice or CPDLC). If responding by CPDLC, the controller should use either of the following free text message elements (as appropriate):

- a) **UM 169r** ROGER PAN if the downlink message contains **DM 55 PAN PAN PAN**; or
- b) **UM 169q** ROGER MAYDAY if the downlink message contains **DM 56 MAYDAY MAYDAY MAYDAY**.

Note 1.— For FANS 1/A, the CPDLC emergency messages do not require a closure response. Therefore, the aircraft system will reject receipt of any technical response (i.e. including a MRN), such as the **DM 3 ROGER** message element.

Note 2.— For FANS 1/A, if the controller sends a CPDLC free text message to respond to an emergency message, the flight crew may not send the required response (i.e. **DM 3 ROGER**) to the free text message, depending on workload and the nature of the emergency.

4.8.2.4 The controller should attempt to determine the nature of the emergency and ascertain any assistance that may be required.

4.8.2.5 The ATSU with control responsibility for the flight may choose to:

- a) Shorten the ADS-C periodic reporting interval; or
- b) Send a demand contract request.

Note 1.— Shortening the ADS-C reporting interval reduces the period between cancellation of the ADS-C emergency and receipt of the ADS-C CANCEL EMERGENCY message.

Note 2.— Adjacent ATSUs should not shorten the ADS-C periodic reporting interval.

Note 3.— A demand contract request is not required if the periodic reporting interval has been shortened – an ADS-C report will have already been triggered by the aircraft when the new periodic contract is received.

4.8.3 ADS-C emergency report without a CPDLC emergency message

4.8.3.1 When an ATSU not having control responsibility for the aircraft receives an indication of an ADS-C emergency, they should confirm that the controlling authority has also received the emergency report (see [paragraph 3.1.2.4.2](#) for related information).

4.8.3.2 When an ATSU having control responsibility for the aircraft receives an indication of an ADS-C emergency report without either a CPDLC emergency message or voice confirmation, then it is possible that the aircraft may be subject to unlawful interference or inadvertent activation of the ADS-C

emergency mode. If a subsequent ADS-C report indicates that the aircraft is maintaining normal operations (i.e. the aircraft is operating in accordance with its clearance), the controller should confirm the ADS-C emergency using CPDLC or voice.

4.8.3.3 To confirm activation of the ADS-C emergency mode using CPDLC, the controller should send the following CPDLC free text uplink (or voice equivalent).

Controller	<u>UM 169ak</u> CONFIRM ADS-C EMERGENCY
------------	---

4.8.3.3.1 If the emergency mode has been activated inadvertently, the controller expects the flight crew to cancel the ADS-C emergency and advise the controller either by voice or the following CPDLC messages.

Flight crew	<u>DM 3</u> ROGER, then <u>DM 67ab</u> ADS-C RESET
-------------	---

4.8.3.3.2 If the aircraft continues with the ADS-C emergency mode activated, the controller should assume the aircraft is in emergency conditions and follow normal alerting procedures.

Note.— *The aircraft may not send the ADS-C CANCEL EMERGENCY message until the next ADS-C periodic report is due.*

4.9 Non-routine procedures

4.9.1 General

4.9.1.1 Refer to current ICAO procedures for standards and recommended practices on complete communications failure (CPDLC and voice).

4.9.2 Voice communications related to data link

4.9.2.1 When CPDLC fails and open messages existed at the time of failure, the controller should re-commence any dialogues involving those messages by voice.

4.9.2.2 The controller or radio operator should use the standard voice phraseology under certain conditions as indicated in Table 4-6.

Note.— *See paragraph 5.9.2.2 for standard voice phraseology used by the flight crew.*

Table 4-6. Voice phraseology related to CPDLC

Condition	Voice phraseology
To advise all stations or a specific flight of a complete ground system failure and provide further instructions. (ICAO Doc 4444)	[ALL STATIONS] CPDLC FAILURE (instructions). Example: ALL STATIONS CPDLC FAILURE. DISCONNECT CPDLC. CONTINUE ON VOICE
To instruct the flight crew of a single CPDLC message failure. (ICAO Doc 4444)	CPDLC MESSAGE FAILURE (appropriate clearance, instruction, information or request)
To instruct the flight crew of a correction to a CPDLC clearances, instructions, information or requests. (ICAO Doc 4444)	DISREGARD CPDLC (message type) MESSAGE, BREAK (correct clearance, instruction, information or request)
To instruct all stations or a specific flight to avoid sending CPDLC requests for a limited period of time. (ICAO Doc 4444)	[ALL STATIONS] STOP SENDING CPDLC REQUESTS [UNTIL ADVISED] [(reason)]
To instruct the flight crew to manually initiate a logon to the subsequent ATSU <i>Note.</i> — No equivalent to ICAO Doc 4444.	DISCONNECT CPDLC THEN LOGON TO [facility designation] <i>Note 1.</i> — The [facility designation] is the four character ICAO code. <i>Note 2.</i> — Use this voice phraseology when the CPDLC transfer to an adjacent ATSU has failed.
To advise the flight crew prior to the commencement of a CPDLC shutdown and instruct them to continue on voice. <i>Note.</i> — No equivalent to ICAO Doc 4444.	CPDLC WILL BE SHUT DOWN. DISCONNECT CPDLC. CONTINUE ON VOICE.
To advise all stations or a specific flight to resume normal CPDLC operations and provide the logon address. <i>Note.</i> — Modified from ICAO Doc-4444 to include logon address.	[ALL STATIONS] RESUME NORMAL CPDLC OPERATIONS. LOGON TO [facility designation]

4.9.3 Data link initiation failure

4.9.3.1 In the event of a log on failure by an aircraft in or approaching an ATSU's airspace, and when a flight plan is available, the ATSU should check that the aircraft identification and aircraft registration or address, as well as other details contained in the data link initiation request, correspond with details in the flight plan.

Note.— *In the case of FANS I/A, the geographic position of the aircraft at the time of initiating the logon is contained in the logon request message.*

4.9.3.1.1 If initiation request details differ from the flight plan details, the controller should contact the flight crew to resolve differences between the aircraft details and the flight plan and make the appropriate changes in either the flight plan or the aircraft; and then arrange a re-initiation of the logon process by the flight crew.

4.9.3.1.2 If initiation request details match the flight plan details but the flight is not eligible for log on at this time, the controller should contact the flight crew to arrange a re-initiation of the logon process at an appropriate time.

4.9.3.2 In the event of a log on failure by an aircraft in or approaching an ATSU's airspace, and, when no flight plan is available, the controller should:

- a) If possible, contact the flight crew to obtain sufficient flight plan data to enable a successful log on; and then
- b) Arrange a re-initiation of the logon process.

4.9.3.3 The ANSP should ensure that procedures are in place to notify the appropriate State/regional monitoring agency via a problem report of the failure. (paragraph 3.2.2 refers)

Note.— *When it can be determined that the log on is inappropriate, no action is required.*

4.9.4 Data link service failures

4.9.4.1 CPDLC connection failure

4.9.4.1.1 If a CPDLC dialogue is interrupted by a data link service failure, the controller should re-commence the entire dialogue by voice communication.

4.9.4.1.2 When the controller recognizes a failure of the CPDLC connection, the controller should instruct the flight crew to terminate the connection and then initiate another logon. The controller or radio operator should use the following voice phraseology:

Controller (or radio operator)	CPDLC FAILURE. DISCONNECT CPDLC THEN LOGON TO [facility designation]
Flight crew	ROGER

Note.— *The [facility designation] is the 4 character ICAO code.*

4.9.4.2 Transferring the CPDLC connection – abnormal conditions

4.9.4.2.1 When the automatic transfer of the CPDLC connection fails, the controller should use the following messages via CPDLC. When using voice, use the equivalent voice phraseology:

Controller	UM 169am or UM 183am AUTOMATIC TRANSFER OF CPDLC FAILED. WHEN ENTERING [unit name] AREA DISCONNECT CPDLC THEN LOGON TO [facility designation]
Flight crew	DM 3 ROGER

Note 1.— The [unit name] is expressed as the radiotelephony name, not the 4-character code. The [facility designation] is the relevant four character ICAO code.

Note 2.— Instructing the flight crew to DISCONNECT CPDLC will result in loss of CPDLC connectivity. This procedure should only be applied approaching the boundary with the next ATSU.

4.9.4.3 Data link service failure

4.9.4.3.1 In the event of an unplanned data link shutdown, the relevant ATSU should inform:

a) All affected aircraft using the following voice phraseology:

Controller (or radio operator)	ALL STATIONS CPDLC FAILURE. DISCONNECT CPDLC. CONTINUE ON VOICE
Flight crew	ROGER

b) The adjacent ATSUs by direct coordination; and

c) All relevant parties via the publication of a NOTAM, if appropriate.

Note.— In the event of a planned or unexpected network or satellite data service outage (e.g. ground earth station failure), the CSP will notify all ATSUs within the affected area in accordance with [paragraph 3.1.3.1](#) so the controller can inform affected aircraft.

4.9.4.4 Planned data link shutdown

4.9.4.4.1 During the time period of a planned data link shutdown, the ANSP will advise the operators of the requirements to use voice communication procedures.

4.9.4.4.2 When advising the flight crew prior to the commencement of a planned data link shutdown, the controller should use the following CPDLC message or the radio operator should use the equivalent voice phraseology:

Controller (or radio operator, if voice)	UM 169ax CPDLC WILL BE SHUT DOWN. DISCONNECT CPDLC. CONTINUE ON VOICE <i>Note 1.— The controller could optionally provide the voice frequency.</i>
Flight crew	DM 3 ROGER <i>Note 2.— The controller expects the flight crew to terminate the CPDLC connection and continue on voice.</i>

4.9.4.5 CPDLC or ADS-C service failure

4.9.4.5.1 Some ATSU's are not equipped with both CPDLC and ADS-C and consequently may experience a failure of either the CPDLC or ADS-C service. For ATSU's that have both CPDLC and ADS-C, both components can fail independently or simultaneously.

4.9.4.5.2 When the ADS-C service is shut down, the affected ATSU should inform all other affected parties of the shutdown and likely duration.

4.9.4.5.3 If the CPDLC service is still available, the controller should revert to either CPDLC or voice to fulfill the position reporting requirement. The controller should then send a CPDLC message to notify the flight crew of position reporting requirements using either of the following free text messages:

Controller	UM 169ao ADS-C SHUT DOWN AT [facility designation]. REVERT TO CPDLC POSITION REPORTS. LEAVE ADS-C ARMED.
Flight crew	DM 3 ROGER

or

Controller	UM 169at ADS-C SHUT DOWN AT [facility designation]. REVERT TO VOICE POSITION REPORTS. LEAVE ADS-C ARMED.
Flight crew	DM 3 ROGER

Note.— The [facility designation] is the 4 character ICAO code.

4.9.4.5.4 When an ADS-C contract cannot be established, or if ADS-C reporting from an aircraft ceases unexpectedly, the controller should instruct the flight crew, using the following CPDLC message or use equivalent voice phraseology:

Controller	UM 169an CONFIRM ADS-C ARMED
Flight crew	DM 3 ROGER

Note.— The flight crew may have inadvertently selected ADS-C off. If ADS-C had been turned off, re-arming it will not re-initiate previous ADS contracts. The ATSU will need to establish new ADS contracts.

4.9.4.6 Resuming data link operations

4.9.4.6.1 The controller or radio operator should use the following voice phraseology to advise the flight crew that the CPDLC system has resumed operations.

Controller (or radio operator)	[ALL STATIONS] RESUME NORMAL CPDLC OPERATIONS. LOGON TO [facility designation]
Flight crew	LOGON [facility designation]

Note.— The [facility designation] is the 4 character ICAO code.

4.9.4.6.2 The controller or radio operator should use the following voice phraseology to advise the flight crew that the CPDLC and ADS-C system has resumed operations.

Controller (or radio operator)	[ALL STATIONS] RESUME NORMAL CPDLC and ADS-C OPERATIONS. CPDLC AND VOICE POSITION REPORTS NOT REQUIRED
Flight crew	LOGON [facility designation]

Note.— The [facility designation] is the 4 character ICAO code.

4.9.4.6.3 The controller or radio operator should use the following CPDLC message or use equivalent voice phraseology to advise the flight crew that the ADS-C system has resumed operations and CPDLC and voice position reports are not required.

Controller (or radio operator)	UM 169aw RESUME NORMAL ADS-C OPERATIONS. CPDLC AND VOICE POSITION REPORTS NOT REQUIRED
Flight crew	DM 3 ROGER

4.9.4.7 Inaccurate time estimates

4.9.4.7.1 If ADS-C or CPDLC position reports indicate inaccurate time estimates. The controller should notify the flight crew using voice or the following free text message:

Controller	UM 169h ADS-C ESTIMATES APPEAR INACCURATE. CHECK FMS.
Flight crew	DM 3 ROGER

4.9.4.8 SATCOM failure

4.9.4.8.1 If the flight crew advises that a SATCOM failure has occurred on the aircraft and the failure affects the separation minimum currently being applied, the controller should establish an appropriate separation minimum.

4.9.5 Using CPDLC to relay messages

4.9.5.1 In airspace where procedural separation is being applied, when an ATSU and an aircraft cannot communicate, the controller may use CPDLC to relay messages via an intermediary CPDLC-capable aircraft. Depending on circumstances, the controller may first confirm that the CPDLC-capable aircraft is in contact with the subject aircraft, and should obtain concurrence from the flight crew that they will act as an intermediary. The controller should only use free text, with the following form:

Controller	<p>UM 169ap RELAY TO [call sign] [unit name] [text of message to be relayed]</p> <p>Where:</p> <ul style="list-style-type: none"> • [call sign] is expressed as the radiotelephony call sign, rather than the ICAO three letter or IATA two letter designator; • [unit name] is expressed as the radiotelephony name, not the 4-character code; and • [text of message to be relayed] conforms to the guidelines provided paragraph 3.1.1.4 and 4.3.2 (e.g. CLEARs [call sign] CLIMB TO AND MAINTAIN FL340). <p><i>Note.— The use of standard message elements is prohibited because the intermediary aircraft's FMS could be unintentionally armed.</i></p>
Flight crew	DM 3 ROGER
Flight crew	DM 67ae RELAY FROM [call sign] [response parameters]

Example:

Controller	UM 169ap RELAY TO UNITED345 OAKLAND CLEARs UNITED345 CLIMB TO AND MAINTAIN FL340
Flight crew	DM 3 ROGER
Flight crew	DM 67ae RELAY FROM UNITED345 CLIMBING FL340

Chapter 5. Flight crew procedures

5.1 Overview

5.1.1 General

5.1.1.1 The operator may be required to obtain an operational authorization by the State of the Operator or State of Registry to use CPDLC and ADS-C services in accordance with [paragraph 3.2](#). This chapter provides guidance on procedures for the flight crew in airspace where data link services are available.

5.1.1.2 These procedures are intended to assist operators in the development of:

- a) Operating procedures and associated documentation; and
- b) Appropriate training programs.

5.1.1.3 Flight crews should be knowledgeable in operating manuals for use of the data link system specific to the aircraft type.

Note.— Refer to [paragraph 3.2.1.3](#).

5.1.1.4 Flight crews should be knowledgeable in data link operations.

Note 1.— Refer to [Chapter 2](#) for an overview of data link operations.

Note 2.— Where applicable, the communication procedures for the provision of CPDLC shall be in line with ICAO Annex 10, Volume II and Volume III, Part I, Chapter 3. CPDLC message element intent and text and associated procedures are, in general, consistent with ICAO Doc 4444 PANS-ATM Chapter 12 – Phraseologies and Chapter 14 – CPDLC.

5.1.2 Operational differences between voice communications and CPDLC

5.1.2.1 Development, testing, and operational experience have highlighted fundamental differences between CPDLC and voice communications. These differences need to be considered when developing or approving flight crew procedures involving the use of CPDLC.

5.1.2.2 For example, when using voice communications, each flight crew member hears an incoming or outgoing ATS transmission. With voice, the natural ability for each flight crew member to understand incoming and outgoing transmissions for their own aircraft has provided a certain level of situational awareness among the flight crew. With CPDLC, flight crew procedures need to ensure that the flight crew has an equivalent level of situational awareness associated with understanding the content and intent of a message in the same way.

5.1.2.3 Each flight crew member (e.g. pilot flying and pilot monitoring) should individually review each CPDLC uplink message prior to responding to and/or executing any clearance, and individually review each CPDLC downlink message prior to transmission.

5.1.2.4 If an operator uses augmented crews, the flight crew carrying out the ‘handover’ briefing should thoroughly brief the ‘changeover’ flight crew or flight crew member on the status of ADS-C and CPDLC connections and messages, including a review of any pertinent uplink and downlink CPDLC messages (e.g. conditional clearances).

5.1.2.5 Uplink messages require special attention to prevent the flight crew from responding to a clearance with **DM 0** WILCO, but not complying with that clearance. To minimize errors, when responding to a clearance with **DM 0** WILCO, each flight crew member should read the uplink message individually (silently) before initiating a discussion about whether and how to act on the message. Reading a message individually is a key element to ensuring that each flight crew member does not infer any preconceived intent different from what is intended or appropriate. Use of this method can provide a flight crew with an acceptable level of situational awareness for the intended operations.

5.1.2.6 In a similar manner, each flight crew member should individually review CPDLC downlink messages before the message is sent. Having one flight crew member (e.g. the pilot monitoring) input the message and having a different flight crew member (pilot flying) review the message before it is sent provides an adequate level of situational awareness comparable to or better than voice communication.

5.1.2.7 The flight crew should coordinate uplink and downlink messages using the appropriate flight deck displays. Unless otherwise authorized, the flight crew should not use printer-based information to verify CPDLC messages as printers are not usually intended for this specific purpose.

Note.— For aircraft that have CPDLC message printing capabilities, there are constraints associated with the use of the flight deck printer. Printers may not produce an exact copy of the displayed clearance with the required reliability, and should not be used as the primary display for CPDLC. However, in some cases, printed copies may assist the flight crew with clearances and other information that are displayed on more than one page, conditional clearances and crew handover briefings.

5.1.3 When to use voice and when to use CPDLC

5.1.3.1 When operating within airspace beyond the range of DCPC VHF voice communication, CPDLC is available and local ATC procedures do not state otherwise, the flight crew should normally choose CPDLC as the means of communication. The flight crew would use voice as an alternative means of communication (e.g. VHF, HF or SATVOICE direct or via a radio operator). However, in any case, the flight crew will determine the appropriate communication medium to use at any given time.

5.1.3.2 In airspace where both DCPC VHF voice and CPDLC communication services are provided, and local ATC procedures do not state otherwise, the flight crew will determine the communication medium to use at any given time.

Note.— ICAO Doc 4444, paragraph 8.3.2, requires that DCPC be established prior to the provision of ATS surveillance services, unless special circumstances, such as emergencies, dictate otherwise. This does not prevent the use of CPDLC for ATC communications, voice being immediately available for intervention and to address non-routine and time critical situations.

5.1.3.3 To minimize pilot head down time and potential distractions during critical phases of flight, the flight crew should use voice for ATC communications when operating below 10,000 ft AGL.

5.1.3.4 While the CPDLC message set, as defined in [Appendix A](#), generally provides message elements for common ATC communications, the flight crew may determine voice to be a more appropriate means depending on the circumstances (e.g. some types of non-routine communications).

Note.— Refer to [paragraph 5.8](#) for guidelines on use of voice and data communications in emergency and non-routine situations.

5.1.3.5 During an emergency, the flight crew would normally revert to voice communications. However, the flight crew may use CPDLC for emergency communications if it is either more expedient or if voice contact cannot be established. Refer to [paragraph 5.8.2](#) for guidelines on use.

Note.— For ATN B1 aircraft, emergency message elements are not supported. See [Appendix A, paragraph A.4](#), for a list of emergency message elements.

5.1.3.6 Except as provided in [paragraph 5.8.1.2](#), the flight crew should respond to a CPDLC message via CPDLC, and should respond to a voice message via voice.

Note.— This will lessen the opportunity for messages to get lost, discarded or unanswered between the ATSU and the flight crew and cause unintended consequences.

5.1.3.7 If the intent of an uplink message is uncertain, the flight crew should respond to the uplink message with [DM 1](#) UNABLE and obtain clarification using voice.

Note.— For FANS 1/A aircraft, some uplink messages do not have a [DM 1](#) UNABLE response. On these aircraft, the flight crew should respond with [DM 3](#) ROGER and then obtain clarification via voice.

5.1.3.8 Regardless of whether CPDLC is being used, the flight crew should continuously monitor VHF/HF/UHF guard frequency. In addition, the flight crew should continuously maintain a listening or SELCAL watch on the specified backup or secondary frequency (frequencies). On aircraft capable of two SATCOM channels, one channel may be selected to the phone number for the radio facility assigned to the current ATSU to enable timely voice communications. The second channel may be selected to the company phone number to enable timely voice communications with company dispatch.

5.2 Logon

5.2.1 General

5.2.1.1 A CPDLC connection requires a successfully completed logon procedure before the ATSU can establish a CPDLC connection with the aircraft.

Note.— Refer to [paragraph 2.2.1.2](#) for an overview of the logon procedure.

5.2.1.2 Prior to initiating the logon, the flight crew should verify the following:

- a) The aircraft identification provided when initiating the logon exactly matches the aircraft identification (Item 7) of the filed flight plan;
- b) The flight plan contains the correct aircraft registration in Item 18 prefixed by REG/;
- c) The flight plan contains the correct aircraft address in Item 18 prefixed by CODE/, when required;

d) The flight plan contains the correct departure and destination aerodromes in Items 13 and 16, when required; and

e) The aircraft registration provided when initiating the logon exactly matches the aircraft placard, when the flight crew manually enters the aircraft registration. Refer to [Appendix F, paragraph F.1](#) for aircraft types that require manual entry.

Note.— If a logon request has been initiated with incorrect aircraft identification and aircraft registration, the logon process will fail. The flight crew will need to correct the information and reinitiate the logon request.

5.2.1.3 If any of the information described in [paragraph 5.2.1.2](#) do not match, the flight crew will need to contact AOC or ATC, as appropriate, to resolve the discrepancy.

Note 1: In accordance with ICAO Doc 4444, the aircraft identification is either the:

a) ICAO designator for the aircraft operating agency followed by the flight identification; or

b) aircraft registration.

Note 2.— The aircraft registration entered into the aircraft system can include a hyphen(-), even though the aircraft registration in the flight plan message cannot include a hyphen.

Note 3.- The ATSU correlates the data sent in a logon request message with flight plan data. If the data does not match, the ATSU will reject the logon request.

5.2.1.4 The flight crew should then manually initiate a logon using the logon address, as indicated on aeronautical charts (See [Figure 5-1](#) for example).

Note 1.— Often the logon address is the same as the 4-letter facility designator but in some airspace a different logon address is used. Refer to [Appendix E](#).

Note 2.— Some aircraft (see [Appendix F, paragraph F.1](#)) implement FANS I/A and ATN B1 capabilities as separate systems and do not comply with ED154A/DO305A. For these aircraft, the flight crew will have to select the appropriate system (FANS I/A or ATN B1) to initiate the logon.

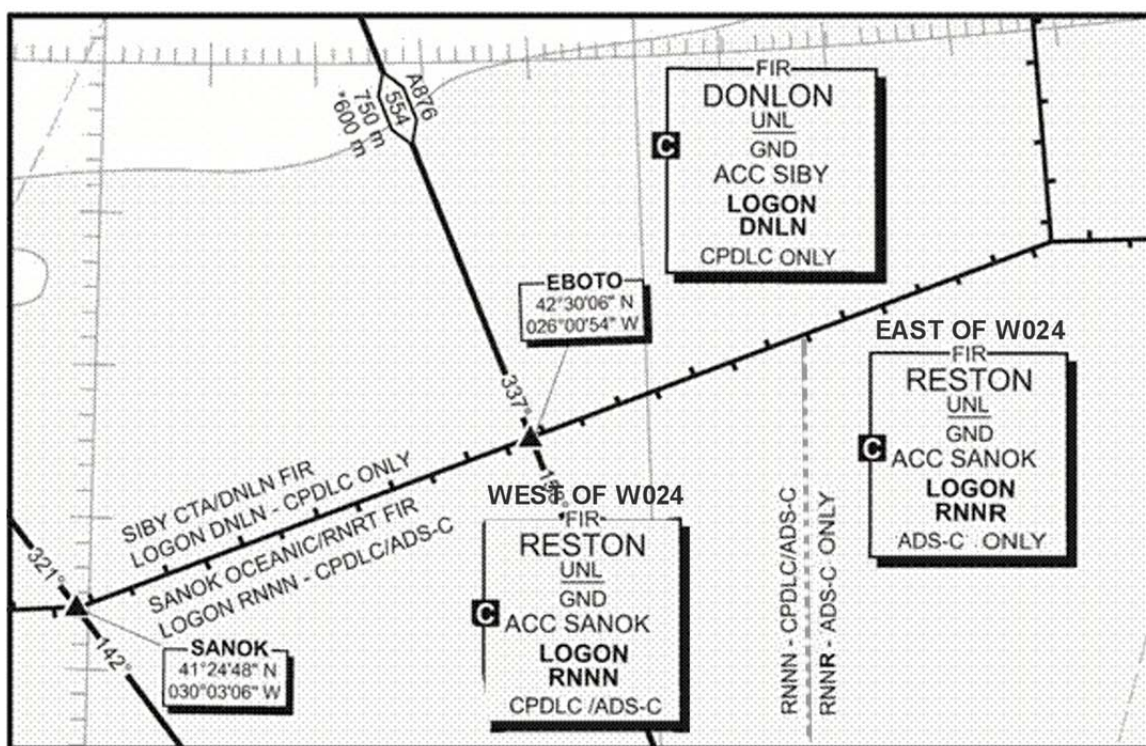

Figure 5-1. Depiction of logon addresses and CPDLC/ADS-C services on en route chart

5.2.1.5 If there are no indications that the logon procedure was unsuccessful, the flight crew can assume that the system is functioning normally and that they will receive a CPDLC connection prior to entry into the next ATSU's airspace.

5.2.1.6 If an indication that the logon procedure was unsuccessful is received, the flight crew should reconfirm that the logon information is correct per [paragraphs 5.2.1.2 and 5.2.1.4](#) and reinitiate a logon.

Note.— If the logon information is correct and the logon process fails, see [paragraph 5.9.3](#) for more information.

5.2.1.7 Each time a CPDLC connection is established, the flight crew should ensure the identifier displayed on the aircraft system matches the logon address for the controlling authority.

5.2.1.8 In the event of an unexpected CPDLC disconnect, the flight crew may attempt to reinitiate a logon to resume data link operations.

5.2.1.9 The flight crew may receive a CPDLC free text message from the ATSU or a flight deck indication regarding the use of the message latency monitor on FANS 1/A+ aircraft. When this message is received, the flight crew should respond as described in [Table 5-1](#) and in accordance with procedures for the specific aircraft type.

Note 1.— Procedures associated with the message latency monitor are applicable only in the European Region and are described in [Appendix E, paragraph E.4.3.2](#).

Note 2.— FANS 1/A aircraft do not support the message latency monitor. Refer to [Appendix F, paragraph F.1](#), for availability of a FANS 1/A+ upgrade on different types of aircraft. Refer to [Appendix F, paragraph F.11](#), for the specifications of the message latency monitor on different types of aircraft.

Table 5-1. Messages and indications regarding use of message latency monitor

Instruction to switch message latency monitor off		
ATSU	UM 169au CONFIRM MAX UPLINK DELAY VALUE IS NOT SET	
Flight crew	<p>FANS 1/A+ aircraft</p> <p>The flight crew should:</p> <ol style="list-style-type: none"> Confirm that the message latency monitor is off (or not set); and Respond to the uplink [free text] message with DM 3 ROGER. 	<p>Message latency monitor not available</p> <p>The flight crew should respond to the CPDLC [free text] message with DM 3 ROGER.</p>
	Instruction to set the maximum uplink delay value	
ATSU	<p>UM 169w SET MAX UPLINK DELAY VALUE TO [delayed message parameter] SECONDS</p> <p>where the [delayed message parameter] is an integer value (e.g. 40).</p>	
Flight crew	<p>FANS 1/A+ aircraft</p> <p>The flight crew should:</p> <ol style="list-style-type: none"> Set the value; and Respond to the uplink message with DM 3 ROGER. 	<p>Message latency monitor not available</p> <p>The flight crew should respond to the uplink [free text] message with DM 3 ROGER and append the DM 67af TIMER NOT AVAILABLE.</p>
	Indication of delayed CPDLC uplink message (Some FANS 1/A+ aircraft only)	
ATSU/ aircraft system	(any CPDLC uplink message displayed with indication of delayed message)	
Flight crew	Some FANS 1/A+ aircraft only	
	<p>The flight crew should:</p> <ol style="list-style-type: none"> Revert to voice communications to notify the ATSU of the delayed message received and to request clarification of the intent of the CPDLC message (paragraph 5.9.2.2 refers); and Respond, appropriately, to close the message per the instructions of the controller. 	

5.2.2 When to log on initially for data link services

5.2.2.1 When operating outside data link airspace, the flight crew should initiate a logon 10 to 25 minutes prior to entry into airspace where data link services are provided.

Note.— *When departing an aerodrome close to or within such airspace, this may require the logon to be initiated prior to departure.*

5.2.2.2 Where a data link service is only provided in upper airspace and where local procedures do not dictate otherwise, the flight crew should log on to that ATSU in whose airspace a data link service will first be used.

5.2.2.3 When failure of a data link connection is detected, the flight crew should terminate the connection and then initiate a new logon with the current ATSU.

5.2.3 Automatic transfer of CPDLC and ADS-C services between ATSUs

5.2.3.1 Under normal circumstances, the current and next ATSUs automatically transfer CPDLC and ADS-C services. The transfer is seamless to the flight crew.

Note.— *The flight crew should not need to reinitiate a logon.*

5.2.3.2 The flight crew should promptly respond to CPDLC uplinks to minimize the risk of an open CPDLC uplink message when transferring to the next ATSU.

Note.— *If a flight is transferred to a new ATSU with an open CPDLC message, the message status will change to ABORTED. If the flight crew has not yet received a response from the controller, the downlink request will also display the ABORTED status. Refer also to [Appendix F, paragraph F.8](#).*

5.2.3.3 Prior to the point at which the current ATSU will transfer CPDLC and/or ADS-C services, the flight crew may receive an instruction to close any open CPDLC messages.

5.2.3.4 When entering the next ATSU's airspace, the flight crew should confirm the successful transfer from the current ATSU to the next ATSU by observing the change in the active center indication provided by the aircraft system.

5.2.3.5 When required by local procedures, the flight crew should send [DM 48](#) POSITION REPORT [position report]. Alternatively, the flight crew may be required to respond to a CPDLC message exchange initiated by the ATSU.

Note.— *Since FANS I/A aircraft do not report that the downstream ATSU has become the CDA, the only way to confirm that it has taken place is for the ATSU to receive a CPDLC message from the aircraft (refer to [Appendix E](#)).*

5.2.4 Transfer voice communications with the CPDLC connection transfer

5.2.4.1 Prior to crossing the boundary, the active center may initiate transfer of voice communications with the CPDLC connection transfer using any of the message elements containing CONTACT or MONITOR. Refer to [paragraph 4.2.3](#) for guidelines on the controller's use of these message elements.

5.2.4.2 A CONTACT or MONITOR message instructs the flight crew to change to the specified frequency and may include a position or time for when to change to the new frequency.

a) When a MONITOR message is received, the flight crew should change to the specified frequency upon receipt of the instruction or at the specified time or position. The flight crew should not establish voice contact on the frequency.

b) When a CONTACT message is received, the flight crew should change to the specified frequency upon receipt of the instruction or at the specified time or position, and establish voice contact on the frequency.

Note 1.— *Some States do not require HF SELCAL checks. If, following a MONITOR instruction, a SELCAL check is specifically required by operator procedures, this will usually be accommodated on the allocated frequency.*

Note 2.— *If the next ATSU provides CPDLC services, the flight crew should not expect that CPDLC will be terminated or suspended once voice contact is established per receipt of a CONTACT message, unless otherwise advised per [paragraph 4.2.4.4](#).*

5.2.4.3 If the ATSU assigns a single HF frequency, the flight crew should select another frequency from the same ‘family’ as a secondary frequency.

Note.— *In areas of poor radio coverage, the controller may append [UM 238](#) SECONDARY FREQUENCY [frequency] to specify a secondary frequency.*

5.2.5 Exiting CPDLC and ADS-C service areas

5.2.5.1 The flight crew should consult the current ATSU prior to the manual termination of any ADS contract with the aircraft, even if it is suspected to be unnecessary or that its termination has failed.

Note.— *ADS contracts are managed (e.g. established and terminated) by ATSUs per [paragraph 4.5.3](#).*

5.2.5.2 Approximately 15 minutes after exiting CPDLC and/or ADS-C service areas, the flight crew should ensure there are no active CPDLC or ADS-C connections. Ensuring that connections are not active eliminates the possibility of inadvertent or inappropriate use of the connections, and reduces operating costs and loading of the system.

Note.— *Some ATSUs may maintain ADS contracts with an aircraft for a period of time (e.g. 15 minutes) after the aircraft has left the airspace.*

5.3 CPDLC – ATS uplink messages

5.3.1 General

5.3.1.1 When a CPDLC uplink is received, each flight crew member (e.g. pilot flying and pilot monitoring) should read the message from the flight deck displays individually to ensure situational awareness is maintained. Once the message has been individually read, the flight crew should then discuss whether to respond to the message with [DM 0](#) WILCO or [DM 3](#) ROGER, as appropriate, or [DM 1](#) UNABLE.

5.3.1.2 When processing an uplink multi-element message, the flight crew should ensure that the entire uplink has been read and understood in the correct sequence prior to responding.

Note.— A CPDLC multi-element message is one that contains multiple clearances and/or instructions. The display may only show part of a CPDLC multi-element message and require flight crew interaction to see the entire message.

Example:

Controller	UM 20 CLIMB TO FL350 or CLIMB TO AND MAINTAIN FL350. UM 128 REPORT LEAVING FL330. UM 129 REPORT MAINTAINING FL350 or REPORT LEVEL FL350.
Flight crew	DM 0 WILCO

5.3.1.3 If multiple clearances are received in a single message, the flight crew should only respond with **DM 0** WILCO if all the clearances in the entire message can be complied with.

5.3.1.4 If the flight crew cannot comply with any portion of a multi-element message, the flight crew should respond to the entire message with **DM 1** UNABLE.

Note.— The flight crew can only provide a single response to the entire multi-element uplink message. The flight crew cannot respond to individual elements of a multi-element message and should not execute any clearance contained in the message.

5.3.1.5 When an uplink responded to with **DM 0** WILCO or **DM 3** ROGER, the flight crew should take appropriate action to comply with the clearance or instruction.

Note.- Although a **DM 0** WILCO or **DM 3** ROGER response technically closes the uplink message, in some cases, other responses may follow to provide additional information, as requested, to operationally close the message.

5.3.1.6 The flight crew should respond to an uplink message with the appropriate response(s), as provided in [Appendix A, paragraph A.4](#).

Note 1.— The flight crew may need to perform some action before a subsequent CPDLC message can be displayed.

Note 2.- For ATN-B1 systems, if the ground system does not receive a response within 120 seconds from the time the uplink message was sent, the ATSU will send an ERROR message for display to the flight crew and both the aircraft and ground system close the dialogue.

5.3.1.7 When a message is received containing only free text, or a free text element combined with elements that do not require a response, the flight crew should respond to the message with **DM 3** ROGER before responding to any query that may be contained in the free text message element.

Example:

Controller (free text)	UM 169b REPORT GROUND SPEED.
Flight crew	DM 3 ROGER

Flight crew (free text)	DM 671 GROUND SPEED 490 or <i>GS 490</i>
----------------------------	---

5.3.2 Flight crew response times for CPDLC uplink messages

5.3.2.1 System performance requirements have been established to support reduced separation standards. Specific latency times have been allocated to the technical performance, and flight crew and controller response times. Regional/State monitoring agencies analyze actual performance to ensure the technical and operational components of the system meet required standards. For example, to support RCP 240 operations, the flight crew is expected to be able to respond to a CPDLC uplink message within one minute.

5.3.2.2 For an ATN-B1 aircraft, the flight crew should respond to a CPDLC uplink message within 100 seconds to prevent the CPDLC uplink message from automatically timing out.

Note.- ATN-B1 aircraft use a CPDLC message response timer, which is set at 100 seconds upon receipt of the CPDLC uplink message. If the flight crew has not sent a response within this time:

- a) the flight crew is no longer provided with any response prompts for the message;
- b) the aircraft sends an **ERROR** message for display to the controller; and
- c) the aircraft and ground systems close the dialogue.

5.3.2.3 When a CPDLC uplink message automatically times out, the flight crew should contact ATC by voice.

5.3.2.4 The flight crew should respond to CPDLC messages as soon as practical after they are received. For most messages, the flight crew will have adequate time to read and respond within one minute. However, the flight crew should not be pressured to respond without taking adequate time to fully understand the CPDLC message and to satisfy other higher priority operational demands. If additional time is needed, the flight crew should send a **DM 2** STANDBY response.

*Note.— For ATN B1 aircraft systems, if the flight crew does not send an operational response within 100 seconds after the **DM 2** STANDBY was sent, the CPDLC uplink message will time out (refer to [paragraph 5.3.2.3](#)).*

5.3.2.5 If a **DM 2** STANDBY response has been sent, the flight crew should provide a subsequent closure response to the CPDLC message.

*Note 1.— In the case of a **DM 2** STANDBY response, the uplink message remains open until the flight crew responds with a **DM 0 WILCO** or **DM 1 UNABLE**. If the closure response is not received within a reasonable period of time, the controller is expected to query the flight crew per [paragraph 4.3.1.2](#).*

Note 2.— Transmission times for messages may vary for a number of reasons including the type of transmission media, network loading, or the criteria for transitioning from one media to another (e.g. VHF/Satcom). Operational response times may vary depending on workload and complexity of the instruction or clearance.

5.3.3 Conditional clearances

5.3.3.1 Conditional clearances require special attention by the flight crew, particularly for a non-native English speaking flight crew. A conditional clearance is an ATC clearance given to an aircraft with certain conditions or restrictions such as changing a flight level based on a time or place. Conditional clearances add to the operational efficiency of the airspace. Conditional clearances, however, have been associated with a large number of operational errors. Following guidelines provided in [paragraphs 5.1.2 and 5.3.1](#), such as each flight crew member individually reading the uplinked clearances and conducting briefings with augmented crews, should aid in reducing errors.

5.3.3.2 The flight crew should correctly respond to conditional clearances containing “AT” or “BY”, taking into account the intended meaning and any automation features provided by the aircraft systems. [Table 5-2](#) clarifies the intended meaning for conditional clearance message elements. (Refer also to [Appendix A, paragraph A.3.](#))

Table 5-2. Conditional clearance clarification of vertical clearances

Message Intent	Message element
<p>Instruction that at the specified time a climb to the specified level is to commence and once reached the specified level is to be maintained.</p> <p><i>Note 1.— Instruction that, NOT BEFORE the specified time, a climb to the specified level is to commence and, once reached, the specified level is to be maintained.</i></p> <p><i>Note 2.— This message element would be preceded with UM 19 MAINTAIN [level], to prevent the premature execution of the instruction.</i></p>	<p>UM 21 AT [time] CLIMB TO [level] or AT [time] CLIMB TO AND MAINTAIN [altitude]</p>
<p>Instruction that at the specified position a climb to the specified level is to commence and once reached the specified level is to be maintained.</p> <p><i>Note 1.— Instruction that, AFTER PASSING the specified position, a climb to the specified level is to commence and, once reached, the specified level is to be maintained.</i></p> <p><i>Note 2.— This message element would be preceded with UM 19 MAINTAIN [level], to prevent the premature execution of the instruction.</i></p>	<p>UM 22 AT [position] CLIMB TO [level] or AT [position] CLIMB TO AND MAINTAIN [altitude]</p>
<p>Instruction that at a specified time a descent to a specified level is to commence and once reached the specified level is to be maintained.</p> <p><i>Note 1.— Instruction that, NOT BEFORE the specified time, a descent to the specified level is to commence and, once reached, the specified level is to be maintained.</i></p> <p><i>Note 2.— This message element would be preceded with UM 19 MAINTAIN [level], to prevent the premature execution of the instruction.</i></p>	<p>UM 24 AT [time] DESCEND TO [level] or AT [time] DESCEND TO AND MAINTAIN [altitude]</p>

Message Intent	Message element
<p>Instruction that at the specified position a descent to the specified level is to commence and once reached the specified level is to be maintained.</p> <p><i>Note 1.</i>— <i>Instruction that, AFTER PASSING the specified position, a descent to the specified level is to commence and, once reached, the specified level is to be maintained.</i></p> <p><i>Note 2.</i>— <i>This message element would be preceded with UM 19 MAINTAIN [level], to prevent the premature execution of the instruction.</i></p>	<p>UM 25 AT [position] DESCEND TO [level] or AT [position] DESCEND TO AND MAINTAIN [altitude]</p>
<p>Instruction that a climb is to commence at a rate such that the specified level is reached at or before the specified time. When this message element is not concatenated with another vertical clearance, the level specified is the assigned level which is to be maintained.</p> <p><i>Note.</i>— <i>Instruction that a climb is to commence at a rate such that the specified level is reached NOT LATER THAN the specified time.</i></p>	<p>UM 26 CLIMB TO REACH [level] BY [time]</p>
<p>Instruction that a climb is to commence at a rate such that the specified level is reached at or before the specified position. When this message element is not concatenated with another vertical clearance, the level specified is the assigned level which is to be maintained.</p> <p><i>Note.</i>— <i>Instruction that a climb is to commence at a rate such that the specified level is reached BEFORE PASSING the specified position.</i></p>	<p>UM 27 CLIMB TO REACH [level] BY [position]</p>
<p>Instruction that a descent is to commence at a rate such that the specified level is reached at or before the specified time. When this message element is not concatenated with another vertical clearance, the level specified is the assigned level which is to be maintained.</p> <p><i>Note.</i>— <i>Instruction that a descent is to commence at a rate such that the specified level is reached NOT LATER THAN the specified time.</i></p>	<p>UM 28 DESCEND TO REACH [level] BY [time]</p>
<p>Instruction that a descent is to commence at a rate such that the specified level is reached at or before the specified position. When this message element is not concatenated with another vertical clearance, the level specified is the assigned level which is to be maintained.</p> <p><i>Note.</i>— <i>Instruction that a descent is to commence at a rate such that the specified level is reached BEFORE PASSING the specified position.</i></p>	<p>UM 29 DESCEND TO REACH [level] BY [position]</p>

5.3.4 “EXPECT” uplink messages

5.3.4.1 “EXPECT” uplink messages are typically received in response to a flight crew request, and, in some cases, when procedurally required per [paragraph 4.3.3](#).

5.3.4.2 When receiving an EXPECT uplink message, the flight crew should respond with **DM 3** ROGER, meaning that the message was received and understood.

Note 1.— The flight crew should NOT comply with an EXPECT message as if it was a clearance.

*Note 2.— The FANS 1/A CPDLC message set contains EXPECT uplink message elements that the controller should NOT use because of potential misinterpretation in the event of a total communication failure. Some of these message elements have been reserved by Doc 4444. As a consequence, some “WHEN CAN WE EXPECT” downlink messages are not supported. See **Appendix A, paragraph A.3**, and **Appendix E, paragraph E.7.1.3**, for specific message elements that are not supported.*

5.3.5 Uplinks containing FMS-loadable data

5.3.5.1 CPDLC allows aircraft systems to be capable of loading route clearance information from CPDLC messages directly into an FMS. The flight crew can use this capability to minimize the potential for data entry errors when executing clearances involving loadable data. It also enables advanced air traffic services supported by data link, such as a re-route or a tailored arrival, as described in **Chapter 6**, which otherwise may not be possible via voice.

Note.— Not all aircraft have the capability to load information from CPDLC message directly into the FMS.

5.3.5.2 If a clearance is received that can be automatically loaded into the FMS, the flight crew should load the clearance into the FMS and review it before responding with **DM 0** WILCO.

5.3.5.3 The flight crew should verify that the route modification in the FMS is consistent with the CPDLC route clearance. A discontinuity in a CPDLC route clearance is not necessarily a reason to respond to the clearance with **DM 1** UNABLE, as these can be appropriate in some circumstances.

5.3.5.4 The flight crew should respond to the clearance with **DM 1** UNABLE when:

a) The FMS indicates that it cannot load the clearance (e.g. partial clearance loaded or unable to load); or

Note.— The FMS checks the clearance to ensure it is correctly formatted and compatible with the FMS navigation database.

b) The FMS indicates any inconsistencies or discontinuities with the route modification that are not addressed by AIP (or other appropriate publication) or cannot be resolved by the flight crew.

5.3.5.5 The flight crew should use CPDLC or voice to clarify any clearance that was responded to with **DM 1** UNABLE due to any loading failures, route discontinuities or inconsistencies.

5.3.5.6 If the clearance loads successfully and is acceptable, the flight crew may execute an FMS route modification and respond to the clearance with **DM 0** WILCO.

Note.— The flight crew will ensure the route in the FMC matches the ATC clearance.

5.4 CPDLC – ATS downlink messages

5.4.1 General

5.4.1.1 Downlink messages can only be sent to the ATSU that holds the active CPDLC connection. To provide situational awareness, procedures should ensure that each flight crew member has read each downlink message before it is sent.

5.4.1.2 When the aircraft has an active CPDLC connection with an ATSU, the flight crew should downlink a clearance request only if the flight is in that ATSU's airspace.

5.4.1.3 The flight crew should use standard downlink message elements to compose and send clearance requests, CPDLC position reports, and other requested reports. Additional qualifying standard message elements, such as **DM 65** DUE TO WEATHER, should also be used as needed.

Note.— The use of standard message elements will minimize the risk of input errors, misunderstandings, and confusion, and facilitate use by a non-native English speaking flight crew. The use of standard message elements allows the aircraft and ground systems to automatically process the information in the messages that are exchanged. For example, the flight crew can automatically load clearance information into the FMS and review the clearance, the ground system can automatically update flight plan data for route conformance monitoring, and both aircraft and ground systems can associate responses to messages.

5.4.1.4 To avoid potential ambiguity, the flight crew should avoid sending multiple clearance requests in a single downlink message. For example, the flight crew should send separate downlink messages for **DM 9** REQUEST CLIMB TO [level] and **DM 22** REQUEST DIRECT TO [position] unless there is an operational need to combine them in a single message (i.e. the flight crew does not want to climb unless they can re-route).

5.4.1.5 When a closure response to an open CPDLC downlink message is not received within a reasonable time period, the flight crew should:

- a) For a FANS 1/A aircraft, send a query using one of the **Negotiation Requests** messages or a **DM 67** [free text] message rather than resending the downlink message. Alternatively, the flight crew may use voice communication to clarify the status of the open CPDLC downlink message; or
- b) For an ATN-B1 aircraft, the flight crew should use voice communication to resolve the operational situation resulting from the timed out CPDLC downlink message.

Note 1.— A closure response is a response that operationally closes the dialogue. A **UM 1** STANDBY response to an open CPDLC downlink message does not operationally close the dialogue.

Note 2.— The use of a CPDLC free text message by a FANS 1/A aircraft avoids multiple open messages involving the same downlink message.

Note 3.— ATN-B1 ground systems will reject duplicate requests and return an **ERROR** message for display to the flight crew **TOO MANY (dialogue type) REQUESTS - EXPECT ONLY ONE REPLY**.

Example:

Flight crew	DM 9 REQUEST CLIMB TO FL350
	Reasonable period of time has passed

Flight crew	<p>DM 53 WHEN CAN WE EXPECT HIGHER LEVEL (or <i>ALTITUDE</i>)</p> <p>or</p> <p>DM 87 WHEN CAN WE EXPECT CLIMB TO FL350</p>
-------------	--

5.4.1.6 If the flight crew receives an indication of non-delivery of a downlink message, they may elect to re-send an identical message within a reasonable amount of time or as required. Alternatively, they may use voice communication to clarify the status of the downlink message.

5.4.2 Free text

5.4.2.1 The flight crew should avoid the use of the free text message element. However, its use may offer a viable solution to enhance operational capability.

Note 1.— The use of standard message elements is intended to reduce the possibility of misinterpretation and ambiguity.

*Note 2.— A free text message (such as **DM 67k** REVISED ETA [position] [time]) does not require a response from the ATSU.*

5.4.2.2 Free text messages should be used only when an appropriate standard message element does not exist.

5.4.2.3 When composing a free text message, the flight crew should use standard ATS phraseology and format and avoid nonessential words and phrases. Abbreviations should only be included in free text messages when they form part of standard ICAO phraseology, for example, ETA.

5.4.3 Unsupported messages

5.4.3.1 While ATSUs should provide CPDLC service using the complete message set provided in **Appendix A**, some ATSUs provide a CPDLC service using a limited message set. The flight crew should be aware of any unsupported downlink message elements that are described in regional or State documentation.

5.4.3.2 If a downlink message, containing a message element that is not supported by the ATSU, is sent, the flight crew will typically receive the uplink message, **UM 162** or **UM 169u** MESSAGE NOT SUPPORTED BY THIS ATS UNIT. If this message is received, the flight crew should respond to the message with **DM 3** ROGER and use voice for the communication transaction.

5.4.4 CPDLC reports and confirmation requests

5.4.4.1 The flight crew should respond to CPDLC reports and confirmation requests, when appropriate.

Note 1.— ATSUs may send a CPDLC message that combines a REPORT instruction with a clearance. The flight crew may use automation, procedures, and/or a combination to remind them when to send the reports requested in the CPDLC message.

Example:

Controller	UM 20 CLIMB TO FL350 or <i>CLIMB TO AND MAINTAIN FL350</i> . UM 128 REPORT LEAVING FL330. UM 129 REPORT MAINTAINING [level] or <i>REPORT LEVEL FL350</i> .
Flight crew	DM 0 WILCO

Note 2.— The controller may send a CPDLC message to request the flight crew to advise intentions when ADS-C indicates the aircraft has deviated from its cleared route, level or assigned speed ([paragraph 4.3.5.2](#) refers).

5.5 Automatic dependant surveillance – contract (ADS-C)

5.5.1 General

5.5.1.1 ADS-C allows the ATSU to obtain position reports from the aircraft without flight crew action to update the current flight plan, to check conformance and to provide emergency alerting.

Note.— In airspace where ADS-C services are available, the flight crew need not send position reports via voice or CPDLC, except as described in [paragraph 5.6.3](#) or when required by regional supplementary procedures or AIP (or other appropriate publication).

5.5.1.2 When using ADS-C services, the flight crew should check to ensure ADS-C is armed prior to initiating a logon with an ATSU.

Note.— The flight crew can switch ADS-C off, which will cancel any ADS-C connections with the aircraft. While ADS-C is disabled, the ground system will not be able to establish an ADS-C connection.

5.5.1.3 Normally, the flight crew should leave ADS-C armed for the entire flight. However, in airspace where ADS-C services are available, if the flight crew switches ADS-C off for any reason, or they receive indication of avionics failure leading to loss of ADS-C service, the flight crew should advise ATC and follow alternative procedures for position reporting per [paragraphs 5.6 and 5.9.4.4](#).

5.5.1.4 In airspace where ADS-C services are not available, the flight crew may switch ADS-C off to cancel inadvertent ADS-C connections. In such cases, the flight crew should ensure that ADS-C is armed when re-entering airspace where ADS-C services are again available.

5.5.1.5 If ADS-C is disabled in an ADS-C environment, the ATSU may send the flight crew an inquiry per [paragraph 5.9.4.6](#).

5.6 Position reporting

5.6.1 General

5.6.1.1 The flight crew should ensure that waypoints are sequenced correctly. If an aircraft passes abeam a waypoint by more than the aircraft FMS waypoint sequencing parameter, the flight crew should sequence the waypoints in the FMS, as appropriate.

Note.— As shown in [Figure 5-2](#), when an aircraft passes abeam a waypoint in excess of the defined sequencing parameter (refer to [Appendix F, paragraph F.7](#) for specific aircraft types), the FMS will not sequence the active waypoint. If the flight crew does not sequence the waypoint, incorrect information will be contained in ADS-C reports, CPDLC position reports and FMC waypoint position reports – the next waypoint in these reports will actually be the waypoint that the aircraft has already passed.

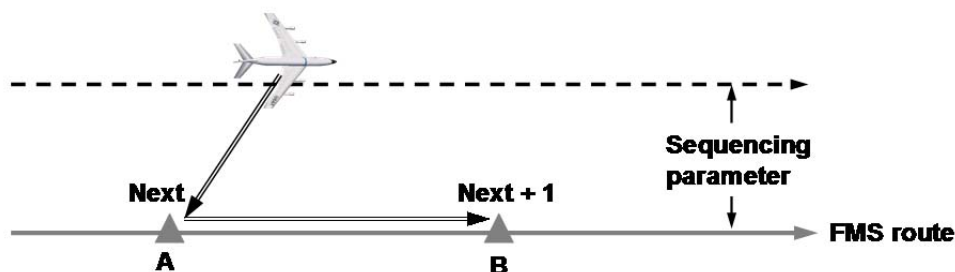

Figure 5-2. Waypoint sequencing anomaly

5.6.1.2 When using CPDLC or FMC WPR to provide position information, the flight crew should use latitudes and longitudes encoded as waypoint names in the ICAO format.

Note 1.— The flight crew should not use the ARINC 424 format.

Note 2.— ARINC 424 describes a 5-character latitude/longitude format for aircraft navigation databases (e.g. 10N40 describes a lat/long of 10N140W). The ATSU will likely reject any downlink message containing waypoint names in the ARINC 424 format.

5.6.2 Position reporting in a non-ADS-C environment

5.6.2.1 When ADS-C is not available, the flight crew should conduct position reporting by voice or CPDLC. When using CPDLC, the flight crew should send [DM 48](#) POSITION REPORT [position report] whenever an ATC waypoint is sequenced, (or passed abeam when offset flight is in progress).

5.6.2.2 When using CPDLC for position reporting, the flight crew should send position reports only at compulsory reporting points and ensure that the position and next position information applies to compulsory reporting points, unless requested otherwise by ATC. The ensuing significant point after the next position may be either a compulsory or non-compulsory reporting point (Refer AIREP form ICAO Doc 4444, Appendix 1).

5.6.3 Position reporting in an ADS-C environment

Note.— In an ADS-C environment, the flight crew should not provide position reports or revised waypoint estimates by CPDLC or voice, unless otherwise instructed or under conditions in certain airspace as stipulated in Regional Supplementary Procedures or AIP (or other appropriate publication) (See also [Appendix E](#)).

5.6.3.1 If required by regional supplementary procedures or AIP (or other appropriate publication), the flight crew should provide a CPDLC position report when either of the following events occurs:

- a) An initial CPDLC connection is established; or
- b) The CPDLC connection transfer has been completed (i.e. at the associated boundary entry position).

Note.— *Some ANSPs require a single CPDLC position report, even when in an ADS-C environment, to provide the controlling ATSU confirmation that it is the CDA and the only ATSU able to communicate with the aircraft via CPDLC (refer to [Appendix E](#)).*

5.6.3.2 The flight crew should include only ATC waypoints in cleared segments of the aircraft active flight plan.

Note.— *If the flight crew inserts non-ATC waypoints (e.g. mid-points) into the aircraft active flight plan and activates the change, the aircraft system may trigger an ADS-C waypoint change event report at the non-ATC waypoint, or include information about the non-ATC waypoint in the predicted route group, as well as the intermediate and fixed projected intent groups. As a result, the ADS-C report will include information about the non-ATC waypoint, which is not expected by the ATC ground system.*

5.6.3.3 The flight crew should maintain the active route in the aircraft system to be the same as the ATC cleared route of flight.

Note.— *If the flight crew activates a non-ATC cleared route into the aircraft system, the ADS-C reports will include information that will indicate the aircraft is flying a route that is deviating from the cleared route.*

5.6.3.4 When reporting by ADS-C only, the flight crew should include ATC waypoints in the aircraft active flight plan even if they are not compulsory reporting points.

5.6.4 Position reporting using FMC WPR

5.6.4.1 Prior to using FMC WPR for position reporting, the flight crew should verify the aircraft identification (ACID) entered into the system is the same as filed in Item 7 of the flight plan.

5.6.4.2 When FMC waypoint position reports are manually initiated, the flight crew should send the report within 3 minutes of crossing each waypoint. If this cannot be achieved, the FMC WPR should not be triggered, but a voice report made instead.

5.6.4.3 The flight crew may assume that the estimate for the next waypoint, shown on the FMS at the time a waypoint is crossed, is the estimate transmitted to ATC in the FMC waypoint position report. If that estimate subsequently changes by more than 2 minutes, the flight crew should transmit a revised estimate via voice to the ATSU concerned as soon as possible.

Note.— *Some regions permit a revised FMC WPR to be transmitted to update a previously notified estimate.*

5.6.4.4 The flight crew should avoid inserting non-ATC waypoints (e.g. mid-points) in route segments because non-ATC waypoints may prevent the provision of proper ETA data in the FMS reports required for ATC purposes.

5.6.4.5 If the flight identification portion of the aircraft identification contains an alphabetic character (such as ABC132A or ABC324W, where 132A or 324W is the flight identification) the flight cannot participate in FMC WPR (see [paragraph 3.4.1.4](#) for more information regarding this limitation).

5.7 Weather deviations and offsets

5.7.1 General

5.7.1.1 The flight crew may use CPDLC to request a weather deviation clearance or an offset clearance. The difference between a weather deviation and an offset is portrayed in [Figure 5-3](#).

- a) A weather deviation clearance authorizes the flight crew to deviate up to the specified distance at their discretion in the specified direction from the route in the flight plan; and
- b) An offset clearance authorizes the flight crew to operate at the specified distance in the specified direction from the route in the flight plan. A clearance is required to deviate from this offset route.

Note.— CPDLC offers more timely coordination of weather deviation clearances. However, the flight crew may deviate due to weather under the provisions of ICAO Doc 4444, paragraph 15.2.3. The extent to which weather deviations are conducted may be a consideration when applying reduced separations, as noted in ICAO Doc 4444, paragraph 5.4.2.6.4.3.

5.7.1.2 Flight crews should use the correct message element when requesting an off-route clearance.

Note.— The difference between a weather deviation and an offset affects how ATC separate aircraft.

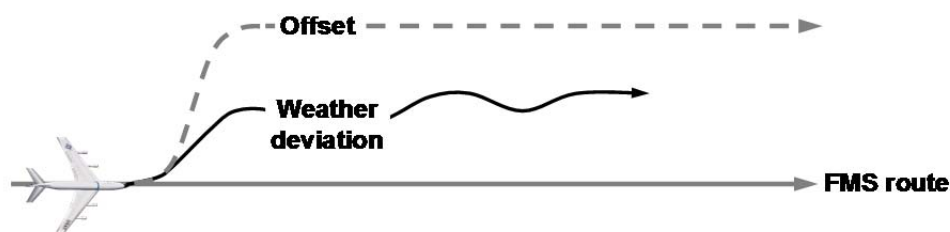

Figure 5-3. Offset and weather deviation

5.7.2 Weather deviation requests and offsets

5.7.2.1 When requesting a weather deviation or offset clearance, the flight crew should specify the distance off route with respect to the cleared route of the aircraft. If the flight crew has received an off-route clearance and then requests and receives a subsequent off-route clearance, the new clearance supersedes the previous clearance (i.e. only the most recent clearance is valid).

Note.— When an off-route clearance has been received, the flight crew will need to ensure that waypoints are sequenced correctly per [paragraph 5.6.1.1](#).

Example 1: As shown in [Figure 5-4](#), the flight crew requests a weather deviation clearance to operate up to 20NM left of route. The controller issues the appropriate clearance.

Flight crew	DM 27 REQUEST WEATHER DEVIATION UP TO 20NM LEFT OF ROUTE
Controller	UM 82 CLEARED TO DEVIATE UP TO 20NM LEFT OF ROUTE UM 127 REPORT BACK ON ROUTE
Flight crew	DM 0 WILCO

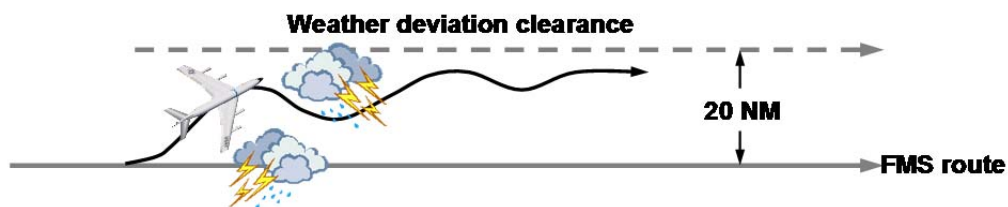

Figure 5-4. Weather deviation clearance up to 20 NM left of route

Example 2: As shown in [Figure 5-5](#), the flight crew is operating on a weather deviation clearance up to 20 NM left of route and then requests another weather deviation clearance to operate up to a further 30NM left of route. In the clearance request, the flight crew specifies a deviation distance from the cleared route rather than from the current weather deviation clearance. The controller issues the appropriate clearance.

Flight crew	DM 27 REQUEST WEATHER DEVIATION UP TO 50NM LEFT OF ROUTE
Controller	UM 82 CLEARED TO DEVIATE UP TO 50NM LEFT OF ROUTE UM 127 REPORT BACK ON ROUTE
Flight crew	DM 0 WILCO

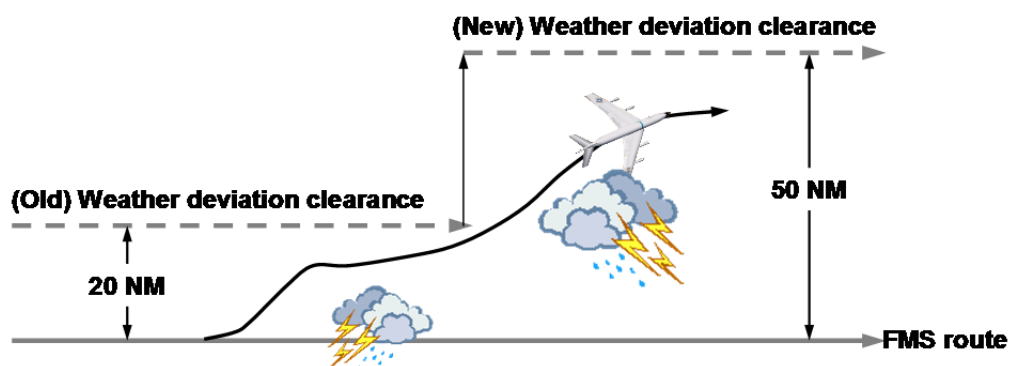

Figure 5-5. Subsequent weather deviation clearance up to 50 NM left of route

Example 3: As shown in [Figure 5-6](#), the aircraft then requests a weather deviation clearance to operate 30NM right of route. The controller issues the appropriate clearance. The flight crew expeditiously navigates from one side of route to the other in accordance with the above clearance.

Note.— The ATSU applies the appropriate separation standards during the maneuvers.

Flight crew	DM 27 REQUEST WEATHER DEVIATION UP TO 30NM RIGHT OF ROUTE
Controller	UM 82 CLEARED TO DEVIATE UP TO 30NM RIGHT OF ROUTE UM 127 REPORT BACK ON ROUTE
Flight crew	DM 0 WILCO

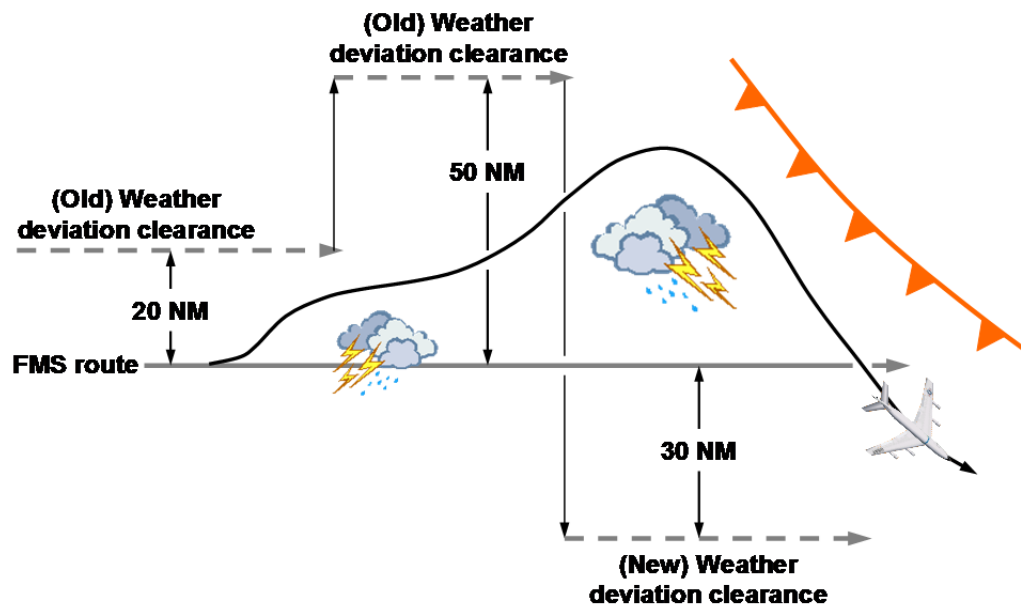

Figure 5-6. Subsequent weather deviation clearance up to 30 NM right of route

5.7.3 Deviations either side of route

5.7.3.1 There are a number of valid formats for the CPDLC [direction] variable. A number of aircraft types, however, can only request one direction (left or right) in weather deviation requests. When operating these aircraft types, the flight crew should request a deviation left and right of route using the following procedures:

- Construct a weather deviation request for a deviation on one side of route using **DM 27** REQUEST WEATHER DEVIATION UP TO [specified distance] [direction] OF ROUTE; and
- Append free text **DM 67ac** AND [specified distance] [direction] describing the distance to the other side of route.

Example: The flight crew requests a deviation left and right of route. The controller issues the appropriate clearance.

Flight crew	DM 27 REQUEST WEATHER DEVIATION UP TO 20NM LEFT OF ROUTE. DM 67ac AND 20NM RIGHT
Controller	UM 82 CLEARED TO DEVIATE UP TO 20NM EITHER SIDE OF ROUTE UM 127 REPORT BACK ON ROUTE
Flight crew	DM 0 WILCO

5.7.4 Reporting back on route

5.7.4.1 When the flight crew no longer needs the deviation clearance and is back on the cleared route, the flight crew should send a **DM 41** BACK ON ROUTE report.

a) If during the weather deviation, the flight crew receives a clearance to proceed direct to a waypoint – and the flight crew responds to the clearance with **DM 0** WILCO – the aircraft is considered to be on the cleared route. Therefore, the flight crew should send a **DM 41** BACK ON ROUTE report after they execute the “direct to” clearance; and

b) If the aircraft is off route during a weather deviation clearance and proceeding direct to a waypoint on the cleared route, the flight crew should send a **DM 41** BACK ON ROUTE report after the aircraft has sequenced the waypoint on the cleared route.

Note.— If a **DM 41** BACK ON ROUTE report is received while the aircraft is still off route, the incorrect information provided to ATC may affect the separation standards in use. Alternatively, the flight crew may consider requesting a clearance direct to the waypoint – on receipt of the uplink clearance, the procedure specified in item a) above applies.

5.8 Emergency procedures

5.8.1 General

5.8.1.1 In accordance with established emergency procedures, the ATSU within whose airspace the aircraft is operating remains in control of the flight. If the flight crew takes action contrary to a clearance that the controller has already coordinated with another sector or ATSU and further coordination is not possible in the time available, then the flight crew performs this action under their emergency command authority.

5.8.1.2 The flight crew will use whatever means are appropriate (i.e. CPDLC and/or voice) to communicate during an emergency.

5.8.1.3 During an emergency, the flight crew would normally revert to voice communications. However, the flight crew may use CPDLC for emergency communications if it is either more expedient or if voice contact cannot be established.

Note.— For ATN B1 aircraft, emergency message elements are not supported. See [Appendix A, paragraph A.4](#), for a list of emergency message elements.

5.8.2 CPDLC and ADS-C emergency

5.8.2.1 When using CPDLC to indicate an emergency situation or degraded operations to an ATSU, the flight crew should use the CPDLC emergency downlink message, either **DM 56** MAYDAY MAYDAY MAYDAY or **DM 55** PAN PAN PAN.

Note 1.— The flight crew may enter PERSONS on BOARD during preflight preparation, prior to initiating a logon, or prior to sending the emergency message.

Note 2.— The CPDLC emergency downlink message will automatically select the ADS-C function to emergency mode. When a situation prohibits sending a CPDLC emergency message (e.g. in an ADS-C

only environment), the flight crew may activate ADS-C emergency mode directly via ADS-C control functions.

5.8.2.2 If a CPDLC emergency downlink message is inadvertently sent or the emergency situation is resolved, the flight crew should send [DM 58](#) CANCEL EMERGENCY as soon as possible to advise the controller and automatically set the ADS-C emergency mode to off. After sending [DM 58](#) CANCEL EMERGENCY, the flight crew should confirm the status of the flight and their intentions via either voice or CPDLC.

5.8.2.3 To check for inadvertent activation of the ADS-C emergency mode using CPDLC, the controller may send the following CPDLC free text uplink or use equivalent voice phraseology:

Controller	UM 169ak CONFIRM ADS-C EMERGENCY
------------	--

The flight crew should then check the status of the aircraft's ADS-C emergency mode and if the emergency mode has been activated inadvertently, the flight crew should select ADS-C emergency mode to off and advise the controller either by voice or by the following CPDLC messages.

Flight crew	DM 3 ROGER, then (free text) DM 67ab ADS-C RESET
-------------	---

5.9 Non-routine procedures

5.9.1 General

5.9.1.1 Refer to current ICAO procedures for standards and recommended practices on complete communications failure (CPDLC and voice).

5.9.2 Voice communications related to data link

5.9.2.1 When CPDLC fails and open messages existed at the time of failure, the flight crew should re-commence any dialogues involving those messages by voice.

5.9.2.2 The flight crew should use the standard voice phraseology under certain conditions as indicated in [Table 5-3](#).

Note.— See [paragraph 4.9.2.2](#) for standard voice phraseology used by the controller or radio operator.

5.9.2.3 Except as provided in [Table 5-3](#) and [paragraph 4.9.2.2](#), voice communication procedures related to data link operations are not standardized among the regions. Refer to [Appendix E](#) for any additional voice communication procedures for a specific region.

Table 5-3. Voice phraseology related to CPDLC

Condition	Voice phraseology
To notify ATC of a correction to a CPDLC message. (ICAO Doc 4444)	DISREGARD CPDLC (message type) MESSAGE, BREAK (correct information or request)
To notify ATC of a single CPDLC message failure. (ICAO Doc 4444)	CPDLC MESSAGE FAILURE (appropriate information or request)
To notify ATC of an aircraft data link system or CPDLC connection failure. (ICAO Doc 4444)	CPDLC FAILURE (requests/notifications) <i>Note.— This voice phraseology is included only with the first transmission made for this reason.</i> Example: CPDLC FAILURE. CONTINUING ON VOICE.
To advise ATC that the CPDLC connection is being terminated manually and logon procedure is being initiated with the next ATSU. <i>Note.— No equivalent to ICAO Doc 4444.</i>	DISCONNECTED CPDLC WITH [facility designation]. LOGGING ON TO [facility designation] <i>Note.— The facility designation is the ICAO four-character facility code or facility name.</i>
To advise ATC that a logon procedure is being initiated following restoration of data link service. <i>Note.— No equivalent to ICAO Doc 4444.</i>	LOGGING ON TO [facility designation]
To advise ATC that a delayed CPDLC uplink has been received and to request clarification of the intent of the CPDLC message. <i>Note.— No equivalent to ICAO Doc 4444.</i>	DELAYED CPDLC MESSAGE RECEIVED (requests) <i>Note.— See paragraph 5.2.1.9 and Appendix F, paragraph F.11 for associated procedures.</i>

5.9.3 Data link initiation failure

5.9.3.1 In the event of a logon failure, the flight crew should confirm the aircraft identification matches the information provided in the FPL and, as appropriate:

- a) Make the necessary corrections; and then
- b) Re-initiate the logon.

5.9.3.2 If no reason for the failure is evident, the flight crew should:

- a) Contact the ATSU by voice to advise of the failure; and
- b) Contact AOC to advise of the failure.

Note.— The ATSU will attempt to resolve the problem.

5.9.3.3 The flight crew should report log-on failures to the appropriate State/regional monitoring agency in accordance with procedures established by the operator ([paragraph 3.2.2](#) refers).

5.9.4 Data link system failures

5.9.4.1 When operating CPDLC and the aircraft data link system provides an indication of degraded performance resulting from a failure or loss of connectivity, the flight crew should notify the ATSU of the failure as soon as practicable, including:

- a) When operating outside of VHF coverage area and the SATCOM data link system fails; and
- b) When operating in airspace where ATS surveillance services are provided and the VHF data link system fails.

Note.— Timely notification is appropriate to ensure that the ATSU has time to assess the situation and apply a revised separation standard, if necessary.

5.9.4.2 If an automatic transfer of the CPDLC connection does not occur at the boundary, the flight crew should contact the transferring ATSU by sending [DM 67j](#) CPDLC TRANSFER FAILURE (or voice equivalent), advising them that the transfer has not occurred.

5.9.4.3 In the event of an aircraft data link system failure, the flight crew should notify the ATSU of the situation using the following voice phraseology:

Flight crew	CPDLC FAILURE. CONTINUING ON VOICE
Controller	ROGER. CONTINUE ON VOICE

Note.— The flight crew continues to use voice until the functionality of the aircraft system can be re-established.

5.9.4.4 When the ATSU provides notification that the CPDLC service has failed or will be shut down, the flight crew should follow the instructions provided in the notification (e.g. disconnect CPDLC and continue on voice until informed by the ATSU that the data link system has resumed normal CPDLC operations).

5.9.4.5 If only the ADS-C service is terminated, then during that time period, the flight crew should conduct position reporting by other means (e.g. CPDLC, if available, or via voice).

5.9.4.6 If the ATSU cannot establish ADS contracts with an aircraft, or if ADS-C reporting from an aircraft ceases, the flight crew may have inadvertently switched ADS-C off. If CPDLC is still available and the flight crew receives the CPDLC message [UM 169an](#) CONFIRM ADS-C ARMED (or voice equivalent), they should check to ensure that ADS-C is not switched off and respond to the controller as follows:

Controller	UM 169an CONFIRM ADS-C ARMED
------------	--

Flight crew	DM 3 ROGER
-------------	-------------------

5.9.4.7 If the aircraft is operating on a vertical profile that is different from the profile programmed in the FMS, the time estimates in the ADS-C report will be inaccurate. If the flight crew receives the message **UM 169h** ADS-C ESTIMATES APPEAR INACCURATE. CHECK FMS, the flight crew should check the FMS, correct any the discrepancy and respond to the CPDLC message with **DM 3** ROGER.

5.9.5 Using CPDLC to relay messages

5.9.5.1 When an ATSU and an aircraft cannot communicate, the controller may use CPDLC or voice to relay messages. When it had been determined to use CPDLC, the controller may first confirm that the CPDLC-capable aircraft is in contact with the subject aircraft. The flight crew should concur that they will act as an intermediary.

5.9.5.2 When using CPDLC to relay messages, the flight crew should:

- a) Only respond with **DM 3** ROGER to CPDLC messages consisting entirely of free text; and
- b) Respond with **DM 1** UNABLE to any CPDLC message containing standard message elements to avoid confusion.

5.9.5.3 After sending **DM 3** ROGER, the flight crew should only use free text to respond to the controller's uplink free text message.

Example, using:

- a) **UM 169ap** RELAY TO [call sign] [unit name] [text of message to be relayed]; and
- b) **DM 67ae** RELAY FROM [call sign] [response parameters]; where.
 - 1) [call sign] is expressed as the radiotelephony call sign, rather than the ICAO three letter or IATA two letter designator; and
 - 2) [response parameters] conform to the guidelines provided **paragraph 5.4.2.3**.

Controller	UM 169ap RELAY TO UNITED345 OAKLAND CLEARS UNITED345 CLIMB TO AND MAINTAIN FL340
Flight crew	DM 3 ROGER
Flight crew	DM 67ae RELAY FROM UNITED345 CLIMBING FL340

Chapter 6. Advanced air traffic services supported by data link

6.1 Re-route procedures

6.1.1 General

6.1.1.1 When re-routing an aircraft, the flight crew, AOC and each ATSU should follow standardized procedures using appropriate CPDLC message elements. For flight crews performing re-routes, see [paragraph 5.3.5](#).

6.1.1.2 The availability of new weather forecasts on long-haul routes may provide the potential for economic and/or safety benefits for operators by allowing them to propose revised routes for airborne aircraft.

6.1.1.3 The flight crew may initiate a re-route request. Each ATSU along the route may initiate an amended route clearance.

6.1.1.4 For flights that cross the common boundary between two automated ATSUs, the ATSUs can coordinate revised route information, reducing the requirement for AOC to transmit modification messages to all the ATSUs along the route.

6.1.1.5 If a re-route clearance changes the NEXT or NEXT+1 waypoint, the flight crew should update the re-route clearance with most current available weather information for the new waypoints/levels.

6.1.2 Re-route procedures – AOC initiated (DARP)

6.1.2.1 The purpose of the dynamic airborne re-route procedure (DARP) is to allow aeronautical operational control (AOC) to initiate the process for an airborne aircraft to be issued an amended route clearance by the ATSU.

6.1.2.2 An operator should only initiate these procedures where the re-route will occur in FIRs where DARP services are available (Refer to [Appendix E](#)).

Note.— DARP service requires Air Traffic Services Interfacility Data Communications (AIDC) to permit the electronic exchange of revised route information.

6.1.2.3 To be eligible for DARP, the operator will need an aircraft with operational CPDLC capability. Additionally, the flight crew should downlink the route request:

- a) At least 60 minutes prior to crossing the next boundary to permit AIDC messaging to take place between the affected ATSUs. This time period may be reduced between ATSUs that support AIDC CDN messaging to coordinate the modification of route information; and
- b) At least 20 minutes prior to the divergence waypoint to allow processing time by the ATSU and the flight crew.

Note.— A downlink route request may be made to a new ATSU immediately after crossing the boundary provided the above requirements are still met.

6.1.2.4 **Table 6-1** provides the procedures for an AOC initiated re-route and **Figure 6-1** provides an overview of the DARP process.

Table 6-1. AOC initiated re-route procedures

Who	Procedures
AOC (Step 1)	<p>a) The AOC should generate the amended route in compliance with standard UPR flight planning requirements (e.g. common boundary waypoints).</p> <p>b) The AOC ensures that the elements used to define the amended route comply with the requirements of ICAO Doc 4444. The elements that may be used to describe the amended route include:</p> <ol style="list-style-type: none"> 1) Fix Names; <i>Note 1.</i>— ARINC 424 fix names should not be used to define latitude and longitude. 2) Airway Designators; <i>Note 2.</i>— Where an airway designator is used it should be preceded and followed by a fix name or navaid designator that is defined on the airway described. 3) Navaid Designators; and 4) Latitude and Longitude. <i>Note 3.</i>— The ICAO requirement is that position should be defined in either whole degrees of latitude and longitude (e.g. 35S164E), or degrees and minutes for both latitude and longitude (e.g. 2513S15645E). A mixture of these formats should be avoided (e.g. 35S15725E). <p>c) The AOC uplinks the proposed route to the aircraft via ACARS.</p>
Flight crew (Step 2)	<p>a) Where applicable, delete any waypoints on the proposed route that have already been sequenced.</p> <p>b) Providing that the proposed route is acceptable to the flight crew, downlink the route request to the controlling ATSU using the CPDLC message element: DM 24 REQUEST CLEARANCE [route clearance] or <i>REQUEST [route clearance]</i> where the first fix in the route clearance is the next waypoint ahead of the aircraft. <i>Note 4.</i>— The route request may also contain additional information such as departure airport, destination airport, etc. <i>Note 5.</i>— Flight crew procedures should include guidance on downlinking CPDLC route clearance requests.</p>

Who	Procedures
ATSU (Step 3)	<p>a) Where the requested clearance is available, uplink the amended route clearance to the aircraft.</p> <p>Example: <u>UM 83</u> AT [position] CLEARED [route clearance] where [position] = [(fix1)] is the next waypoint ahead of the aircraft and [route clearance] = [(fix2) (fix3) ...].</p> <p><i>Note 6.</i>— The route clearance may also contain additional information such as departure airport, destination airport, etc.</p> <p><i>Note 7.</i> — On occasions, other CPDLC message elements may be more appropriate than <u>UM 83</u>.</p> <p>b) Where the requested clearance is not available, uplink <u>UM 0</u> UNABLE and append the [reason].</p> <p>Example: <u>UM 0</u> UNABLE. <u>UM 166</u> DUE TO TRAFFIC</p> <p><i>Note 8.</i>— ATSU should not modify the content of the route without advising the flight crew. This requirement does not apply to the removal of waypoints that have been sequenced prior to the clearance being uplinked or minor changes to the route.</p>
Flight crew (Step 4)	<p>a) On receipt of a CPDLC route clearance from the ATSU, the flight crew should:</p> <ol style="list-style-type: none"> 1) Load the uplink into the FMS and review the clearance. If the clearance is acceptable, respond with <u>DM 0</u> WILCO to confirm that the flight crew will comply with the clearance; or 2) Otherwise: <ol style="list-style-type: none"> i) Respond with <u>DM 1</u> UNABLE; and ii) Continue in accordance with the current ATC clearance.
	<p>b) Where the requested clearance is rejected by the ATSU, the flight crew should continue in accordance with the existing clearance.</p>
	<p>c) The flight crew should request new route data from AOC.</p>

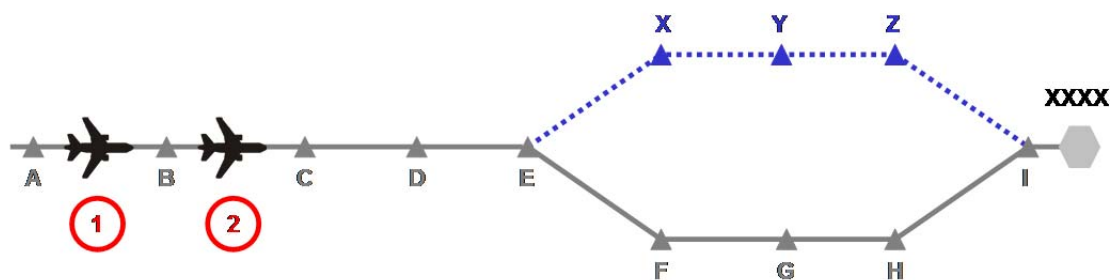

1	<p>The AOC uplinks the proposed amended route “B C D E X Y Z I” to destination XXXX starting from the next point ahead of aircraft (B) and diverging from the current clearance at E.</p> <p>The flight crew reviews the proposed route and downlinks “REQUEST [B C D E X Y Z I]” to ATC.</p>
2	<p>ATC reviews the route request and uplinks the clearance “AT [C] CLEARED [D E X Y Z I]” to the aircraft using UM83.</p> <p><i>Note.— In this example, by the time the clearance is uplinked, the aircraft has passed B and so this is not included in the clearance. Point C must also be removed from the [route clearance] parameter of UM 83 because point C is the [position] at which the reroute clearance begins.</i></p> <p>The flight crew responds to the clearance with a WILCO.</p>

Figure 6-1. The DARP process

6.1.2.5 While the method described in [Figure 6-1](#), step (2), is the preferred method, the following examples show how other CPDLC route clearance message elements could be used in this scenario:

- a) [UM 83](#) AT [E] CLEARED [X Y Z I];
- b) [UM 80](#) CLEARED [C D E X Y Z I]; or
- c) [UM 79](#) CLEARED TO [I] VIA [C D E X Y Z].

Note.— When using [UM 79](#), the position [I] should be a position on the original route of the aircraft

6.1.3 Re-route procedures – ATC initiated

6.1.3.1 The purpose of the ATC initiated re-route procedure is to allow an ATSU to initiate the process to issue an amended route clearance to an airborne aircraft.

6.1.3.2 ATC should be aware that any waypoint that is sent in an uplink message and loaded as part of a new route in the FMS will not contain forecast weather data. It does not make any difference whether the waypoint was previously in the route or not. As a consequence, the flight crew will lose from the FMS all forecast weather data for waypoints that were previously in the route but are uploaded again

as part of the new route. ATC should therefore, as far as possible, restrict the uplinked waypoints to that part of the route that is being amended. Some flight crews may be able to request the missing forecast weather data from the operator.

6.1.3.3 If the re-route clearance changes the NEXT or NEXT+1 waypoint, then ATC may receive an ADS-C report based on zero wind at the next waypoint which may result in an inaccurate estimate for that waypoint.

Note.— See also [paragraph 6.1.1.5](#).

6.1.3.4 ATC should uplink the re-route as soon as practicable to allow processing time by the flight crew prior to the divergence waypoint. For those cases where the aircraft is getting close to the divergence waypoint when the clearance is issued, the controller should consider the option of clearing the aircraft direct to the next waypoint.

6.1.3.5 If the aircraft has passed the divergence waypoint when the CPDLC re-route message is received, the flight crew should select [DM 1](#) UNABLE and continue on the currently cleared route.

6.1.3.6 Aircraft operators should establish procedures for the flight crew to deal with clearances that create route discontinuities. Such procedures should include the flight crew taking an initiative to obtain further route clearance before reaching the waypoint where the route discontinuity occurs if such route clearance has not been received from ATC a reasonable time before reaching the discontinuity waypoint.

6.1.3.7 ATC should only use [UM 83](#) AT [position] CLEARED [route clearance] to issue CPDLC re-route clearances if the following conditions are satisfied:

- a) The route is specified to destination; and
- b) The [position] in [UM 83](#) is on the currently cleared route.

Note.—All forecast weather data after [position] is lost from the FMS when the new route is activated.

6.1.3.8 ATC should only use [UM 80](#) CLEARED [route clearance] to issue CPDLC re-route clearances if the route is specified from the aircraft present position to destination. All forecast weather data is lost from the FMS when the new route is activated.

6.1.3.9 When using [UM 79](#) CLEARED TO [position] VIA [route clearance], ATC should not populate the [position] field with the destination airport unless the route is specified to destination. All forecast weather data for the uplinked waypoints is lost from the FMS when the new route is activated.

6.1.3.10 The [position] in [UM 79](#) CLEARED TO [position] VIA [route clearance] does NOT change the clearance limit for the flight. The clearance limit remains unchanged unless explicitly changed by ATC. Although [UM 79](#) semantically resembles a clearance limit (“CLEARED TO [position] VIA [route]”), it is important to note that the FMS has no concept of a clearance limit. The word “TO” in [UM 79](#) merely signifies the far end of the route segment that is being changed. Although it may coincidentally be identical to the clearance limit previously specified by ATC, this will not normally be the case.

6.1.3.11 [Table 6-2](#) provides the procedures for an ATC initiated re-route, and figures provide an overview of the process for the following cases:

	<u>Figure 6-2</u>	<u>Figure 6-3</u>	<u>Figure 6-4</u>	<u>Figure 6-5</u>	<u>Figure 6-6</u>
First waypoint in new route is on current route.	✓	✓			
There is route discontinuity.		✓		✓	
Aircraft is cleared direct to a fix located downstream in current route.					✓

Table 6-2. ATC initiated re-route procedures

Who	Procedures
ATSU (Step 1)	<p>a) Uplink an amended route clearance to the aircraft and append the [reason] if possible.</p> <p>Example: <u>UM 83</u> AT [position] CLEARED [route clearance] <u>UM 166</u> DUE TO TRAFFIC</p>
Flight crew (Step 2)	<p>a) On receipt of a CPDLC route clearance initiated by an ATSU, the flight crew should:</p> <ol style="list-style-type: none"> 1) Load the uplink into the FMS and review the clearance. If the clearance is acceptable, respond with <u>DM 0</u> WILCO to confirm that the flight crew will comply with the clearance; or 2) Otherwise: <ol style="list-style-type: none"> i) Respond with <u>DM 1</u> UNABLE; and ii) Continue in accordance with the current ATC clearance. <p>b) Where an uplinked clearance is acceptable to the flight crew but creates a route discontinuity, the flight crew should proceed to overcome the potential discontinuity by applying their existing company practices.</p>

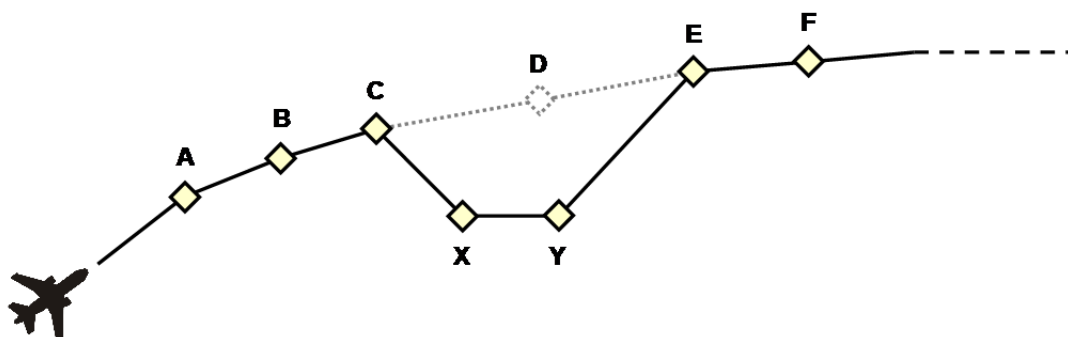

1	<p>a) ATC uplinks the clearance CLEARED TO [E] VIA [A B C X Y] to the aircraft using UM 79 CLEARED TO [position] VIA [route clearance]. There is no discontinuity because the uplink fix (E) is in the existing cleared flight plan; or</p> <p><i>Note 1.— Forecast weather data in the FMS is lost for waypoints A, B, C, D, waypoints X, Y do not contain any forecast weather data, forecast weather data for waypoints E, F, remains intact.</i></p> <p>b) ATC uplinks the clearance CLEARED [A B C X Y E F ...] to the aircraft using UM 80 CLEARED [route clearance]. There is no discontinuity because the entire route has been replaced. The route must be specified to destination; or</p> <p><i>Note 2.— Forecast weather data in the FMS is lost for the whole route.</i></p> <p>c) ATC uplinks the clearance AT [C] CLEARED [X Y E F ...] to the aircraft using UM 83 AT [position] CLEARED [route clearance]. There is no discontinuity because the entire route after C was specified. The route must be specified to destination.</p> <p><i>Note 3.— Forecast weather data in the FMS is lost for all waypoints after C.</i></p>
2	The flight crew responds to the clearance with DM 0 WILCO or DM 1 UNABLE, as appropriate.

Figure 6-2. ATC initiated re-route – first waypoint in the new route is on the current route and there is no route discontinuity

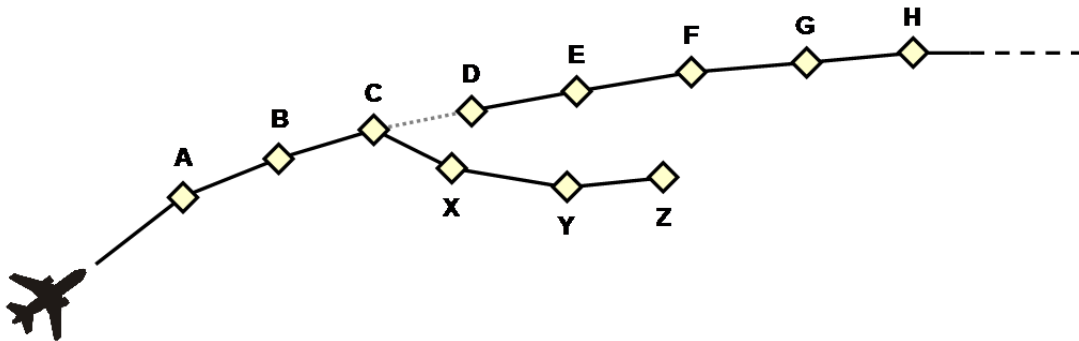

1	<p>ATC uplinks the clearance CLEARED TO [Z] VIA [A B C X Y] to the aircraft using UM 79 CLEARED TO [position] VIA [route clearance].</p> <p><i>Note 1.</i>— Forecast weather data in the FMS is lost for waypoints A, B, C waypoints. X, Y, Z do not contain any forecast weather data. Forecast weather data for waypoints D, E F, G, H etc remains intact.</p> <p><i>Note 2.</i>— In this case, ATC should not use CPDLC message elements UM 80 CLEARED [route clearance] or UM 83 AT [position] CLEARED [route clearance].</p>
2	<p>a) The flight crew responds to the clearance with DM 0 WILCO or DM 1 UNABLE, as appropriate.</p> <p>b) This clearance creates a route discontinuity at Z. The flight crew should obtain further route clearance from ATC before the aircraft reaches Z (that clearance could, for example, be from Z direct to G). In the meantime, the flight crew should overcome the discontinuity at Z by applying their existing company practices under the assumption that a further route clearance will be received before reaching Z.</p>

Figure 6-3. ATC initiated re-route – first waypoint in the new route is on the current route and there is route discontinuity

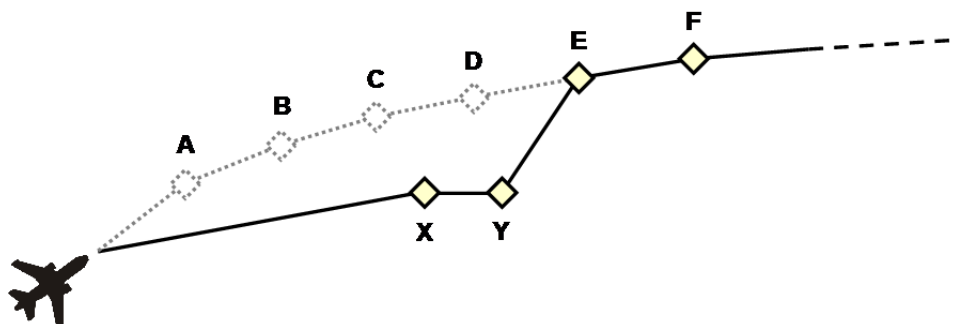

1	<p>a) ATC uplinks the clearance CLEARED TO [E] VIA [X Y] to the aircraft using UM 79 CLEARED TO [position] VIA [route clearance]. There is no discontinuity at E because the uplink fix (E) is in the existing cleared flight plan; or</p> <p><i>Note 1.— Forecast weather data in the FMS is lost for waypoints A, B, C, D, waypoints X, Y do not contain any forecast weather data, forecast weather data for waypoints E, F, etc, remains intact).</i></p> <p>b) ATC uplinks the clearance CLEARED [X, Y, E, F ...] to the aircraft using UM 80 CLEARED [route clearance]. The entire route is replaced and the route must be specified to destination.</p> <p><i>Note 2.— Forecast weather data in the FMS is lost for the whole route.</i></p> <p><i>Note 3.— The clearance in a) and b) above takes immediate effect and, since the first fix specified (X) is not on the existing route of flight, the new route effectively starts with “present position direct X,” although this is not explicitly stated in the uplink message.</i></p> <p><i>Note 4.— In this case, ATC should not use CPDLC message element UM 83 AT [position] CLEARED [route clearance].</i></p>
2	The flight crew responds to the clearance with DM 0 WILCO or DM 1 UNABLE, as appropriate.

Figure 6-4. ATC initiated re-route – first waypoint in the new route is not on the current route and there is no route discontinuity

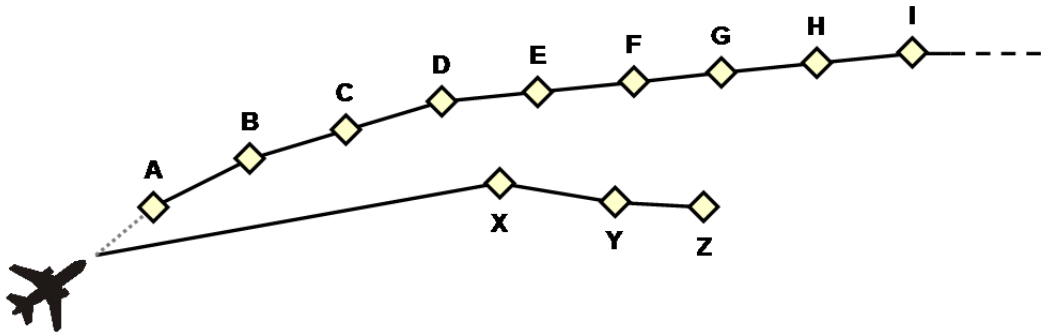

1	<p>ATC uplinks the clearance CLEARED TO [Z] VIA [X Y] to the aircraft using UM 79 CLEARED TO [position] VIA [route clearance].</p> <p><i>Note 1.</i>— Waypoints X, Y, Z do not contain any forecast weather data, forecast weather data for waypoints A, B, C, D, E, F, G, H, I etc remains intact).</p> <p><i>Note 2.</i>— The clearance above takes immediate effect and, since the first fix specified (X) is not on the existing route of flight, the new route effectively starts with "present position direct X," although this is not explicitly stated in the uplink message.</p> <p><i>Note 3.</i> — In this case, ATC should not use CPDLC message elements UM 80 CLEARED [route clearance] or UM 83 AT [position] CLEARED [route clearance].</p>
2	<p>a) The flight crew responds to the clearance with DM 0 WILCO or DM 1 UNABLE, as appropriate.</p> <p>b) This clearance creates a route discontinuity at Z. The flight crew should obtain further route clearance from ATC before the aircraft reaches Z (that clearance could, for example, be from Z direct to I). In the meantime, the flight crew should overcome the discontinuity at Z by applying their existing company practices under the assumption that a further route clearance will be received before reaching Z.</p>

Figure 6-5. ATC initiated re-route – first waypoint in the new route is not on the current route and there is route discontinuity

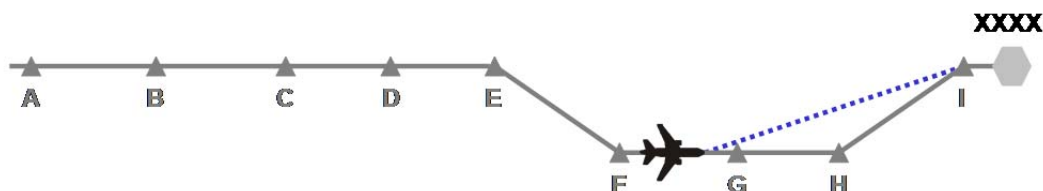

1	ATC uplinks the clearance UM 74 PROCEED DIRECT TO [fix I] to the aircraft.
2	The flight crew responds to the clearance with DM 0 WILCO, immediately loading the clearance into the FMC and proceeding direct to the cleared direct-to fix I.

Figure 6-6. ATC initiated re-route – aircraft is cleared direct to a fix that is located downstream in the current route

6.2 Tailored arrival (TA)

6.2.1 General

6.2.1.1 The tailored arrival (TA) is a 4-dimensional (4-D) arrival procedure, based on an optimized ATC clearance, including, as necessary, vertical and/or speed restrictions, from the aircraft's current position, normally just prior to top of descent, to the designated destination runway. This optimized ATC clearance, or TA clearance, is issued via CPDLC data link message(s) to the aircraft and, upon flight crew selection, automatically loaded into the aircraft's FMS (i.e. 4-D trajectory guidance). The TA clearance generally consists of the lateral path, vertical and speed constraints, published approach procedure, and runway assignment.

6.2.1.2 This section provides guidelines and procedures for delivering and executing the TA clearance. These guidelines and procedures are intended for ANSPs that provide the TA service and participating operators.

Note.— As ANSPs plan for providing the TA service throughout the world, ground system capability and geographical constraints may lead to some variations in local implementations. As experience is gained, these variations and other refinements will need to be coordinated in future amendments to the guidelines provided herein.

6.2.2 Provisions for the TA service

6.2.2.1 The operator should establish operating and notification procedures for the flight crew and conduct training to be eligible to participate in tailored arrivals.

6.2.2.2 At each of the ATSU's where the TA service is available, the ANSP should provide procedures to the controllers and conduct training for constructing and issuing the TA clearance. If the flight crew from an eligible operator requests a TA clearance and the traffic situation permits, the controller should accommodate the request. All other standard operating procedures apply.

6.2.2.3 When the TA service is provided, the ANSP should:

- a) Assign a TA designator to the TA clearance. The TA designator should:
 - 1) Contain more than five letters so that it is not easily confused with a published or public procedure;
 - 2) Relate to the geographical arrival area (e.g. PACIFIC 1 TA); and
 - 3) Be easy to pronounce when communicating on voice.

Note.— The flight crew and the controller use the TA designator throughout the procedure to unambiguously convey the route and vertical and speed constraints associated with the TA.

- b) Define and notify operators of the TA request point as a time in minutes from the estimated top of descent (TOD) or from the airspace boundary where CPDLC service is terminated.

Note.— For example, the TA request point for the PACIFIC 1 TA at San Francisco airport is 45 minutes before the aircraft enters U.S. domestic airspace.

6.2.3 Clearance delivery and execution

6.2.3.1 [Table 6-3](#) provides the procedures for delivering and executing a tailored arrival clearance.

Table 6-3. Tailored arrival clearance delivery and execution

Who	Procedures
Flight crew (Step 1)	<p>At the TA request point, the flight crew should request a TA using the CPDLC standard free text message element:</p> <p>DM 67ad REQUEST TAILORED ARRIVAL [TA designator] [speed] or <i>REQ TA</i> [TA designator] [speed], where [TA designator] and [speed] are optional.</p> <p><i>Note 1.— When the ANSP and operators are evaluating a TA, the flight crew may include additional information such as an intended descent speed, using the format M[nn] for Mach or [nnn]KIAS for IAS. When this information is included, the controller and flight crew procedures should include message formats and intended use to avoid misunderstanding or confusion with the operational procedures.</i></p> <p>Example 1: DM 67ad REQ TA PACIFIC 1.</p> <p>Example 2: DM 67ad REQ TA PACIFIC 1 M.83</p> <p>Example 3: DM 67ad REQ TA 280KIAS</p>
Controller (Step 2)	<p>a) If the situation permits, the controller should uplink the TA clearance via CPDLC using:</p> <p>UM 169 [TA designator]</p> <p>UM 83 AT [position] CLEARED [route clearance]</p> <p>UM 19 MAINTAIN [level]</p> <p>Example: The controller uses the name PACIFIC 1 TA, which is unambiguous for the specific route and vertical and speed constraints. The route clearance includes lateral route, crossing restrictions, approach procedure, and runway assignment, and FL370 is the currently assigned flight level.</p> <p>PACIFIC 1 TA AT CINNY CLEARED [Route Clearance] MAINTAIN FL370.</p> <hr/> <p>b) The controller may issue a vertical clearance after delivery of the tailored arrival clearance, without interfering with the TA clearance. In such cases, the controller should reissue the TA clearance to ensure no ambiguity.</p>

Who	Procedures
Flight crew (Step 3)	<p>a) The flight crew should load the TA clearance into the FMS and review it. If acceptable, the flight crew should activate the route in the FMS and respond to the clearance with DM 0 WILCO. If unacceptable, the flight crew should respond to the clearance with DM 1 UNABLE.</p> <p>b) The flight crew should select the appropriate descent speed schedule (e.g. 280kts (+/- 10kts)) above 10,000ft.</p> <p><i>Note 2.— This procedure provides additional descent profile predictability to the controllers, increasing the potential for the controllers to allow a full TA during congested periods when increased predictability is required due to other traffic. This function will eventually be replaced by ground automation which advises the optimum speed for the descent, based on the entire airspace situation at the expected time of the arrival.</i></p> <p>c) If possible, the flight crew should request FMC waypoint wind and temperature data from AOC.</p>
AOC (Step 4)	AOC should uplink cruise and descent winds to the arriving aircraft to optimize the FMS-calculated profile for the most predictable execution of that profile.
Controller (Step 5)	<p>When required, the controller should transfer control to the next sector and terminate CPDLC and ADS-C connections.</p> <p><i>Note 3.— The transferring sector either manually or automatically advises the next sector that the aircraft is on a particular TA.</i></p>
Flight crew (Step 6)	When instructed, the flight crew should establish voice contact with the next sector using the phraseology [call sign] [TA designator] TAILORED ARRIVAL. [level].

Who	Procedures
Controller (Step 7)	<p>a) The controller should advise [call sign] MAINTAIN [level].</p> <p><i>Note 4.— The controller has access to the uplinked lateral routing and currently assigned level/altitude on the flight strip through ATC interfacility coordination.</i></p> <hr/> <p>b) If the controller needs to add speed control (e.g. to increase the potential for issuing a TA clearance), the controller should advise the flight crew as soon as possible to expect a restriction.</p> <p>Example: [call sign] EXPECT TO DESCEND AT 260 KTS</p> <hr/> <p>c) When appropriate, the controller should issue a descent clearance along the cleared route, using [TA designator] TAILORED ARRIVAL. [dest/area] ALTIMETER/QNH [nnnn] and, as necessary, include a speed or vertical restriction.</p> <p>Example 1: The controller does not issue a speed or vertical restriction. [call sign] DESCEND VIA PACIFIC 1 TAILORED ARRIVAL. KSFO ALTIMETER 29.92.</p> <p>Example 2: The controller issues a speed restriction. [call sign] DESCEND VIA RADFORD 1 TAILORED ARRIVAL. DO NOT EXCEED 260KTS. NZAA QNH 1014.</p> <p>Example 3: The controller issues a vertical restriction. [call sign] DESCEND VIA THE CATALINA 1 TAILORED ARRIVAL BUT AFTER SLI. MAINTAIN [level/altitude].</p> <hr/> <p>d) The controller should transfer control to the next controller.</p>
Flight crew (Step 8)	<p>The flight crew should initiate contact with the next controller using: [call sign] PASSING FLIGHT LEVEL [FLnnn]/ALTITUDE [nn,nnn feet] ON THE [TA designator] TAILORED ARRIVAL. [ATIS code].</p> <p><i>Note 5.— Subsequent exchanges on different frequencies with the same ATSU do not require the flight crew to state the passing level/altitude.</i></p>

Who	Procedures
Controller (Step 9)	<p>If continuation of the TA profile is acceptable to the approach controller, the controller should clear the aircraft for the approach by stating:</p> <ul style="list-style-type: none"> a) [call sign] AFTER [fix name] CLEARED [approach name]; or b) [call sign] DESCEND VIA [TA designator] TAILORED ARRIVAL. CROSS [fixname] AT OR ABOVE [level/altitude]. CLEARED [approach name]; or c) DESCEND VIA THE [TA designator] TAILORED ARRIVAL. EXPECT [runway or procedure name]. <p>Example 1: [call sign] AFTER MENLO CLEARED ILS RW28L APPROACH.</p> <p>Example 2: [call sign] DESCEND VIA THE FLORIDA 8 (or 9) TAILORED ARRIVAL, CROSS PABOY AT OR ABOVE 3000FT. CLEARED LOCALIZER DME RUNWAY 8L APPROACH.</p> <p>Example 3: [call sign] DESCEND VIA THE FLORIDA 9 TAILORED ARRIVAL. EXPECT RUNWAY 09.</p>
Flight crew (Step 10)	<p>If all conditions are acceptable, the flight crew should execute the cleared FMS-directed profile and apply standard approach and landing procedures.</p>
Controller (Step 11)	<ul style="list-style-type: none"> a) At any time, the controller may issue alternative level/altitude, routing, or vectors and discontinue the TA to best suit traffic conditions. When the controller discontinues the TA, the controller should provide instructions including an assigned level/altitude to the flight crew. <ul style="list-style-type: none"> <i>Note 6.— The controller must include an assigned level/altitude because the flight crew does not know the minimum vectoring level/altitude nor do they know the level/altitude of other traffic.</i> b) The controller may clear the aircraft back onto the TA by stating: [call sign] CLEARED DIRECT [Waypoint on TA]. RESUME THE [TA designator] TAILORED ARRIVAL.

6.3 Automatic dependent surveillance – broadcast in-trail procedure (ADS-B ITP)

6.3.1 General

6.3.1.1 The ADS-B ITP is intended to increase the chances of receiving a clearance to climb or descend to a specified flight level as requested by the flight crew. The ADS-B ITP permits the flight crew to request a climb or descent manoeuvre past a maximum of two reference aircraft, in compliance with a longitudinal separation minimum based on distance as determined by the aircraft's ADS-B system during the ITP manoeuvre.

Note.— See ICAO Doc 4444, paragraph 5.4.2.7, for standards for applying the longitudinal separation minimum during an ADS-B ITP manoeuvre. Further guidance can be found in the:

- a) *Manual on Airborne Surveillance Applications (Doc 9994)*;
- b) *In Trail Procedure (ITP) Using Automatic Dependant Surveillance - Broadcast (ADS-B)" (ICAO Circular 325)*; and
- c) *Safety, Performance and Interoperability Requirements Document for In Trail Procedure in Oceanic Airspace (EUROCAE ED-159 / RTCA DO-312) and Supplement*.

6.3.1.2 Prior to requesting an ITP climb or descend manoeuvre, the flight crew uses the ADS-B system to determine if the ITP criteria are met. The ITP criteria are designed such that two aircraft will maintain the ITP separation minimum (specified by ICAO Doc 4444) throughout the manoeuvre while vertical separation is not maintained.

6.3.1.3 This section provides guidelines and procedures for delivering and executing the ADS-B ITP clearance using CPDLC. These guidelines and procedures are intended for ANSPs that provide the ADS-B ITP service and participating operators.

6.3.2 Provisions for the ADS-B ITP service and operator eligibility

6.3.2.1 When using CPDLC to support the ADS-B ITP, the ANSP should adhere to the guidelines for the provision of CPDLC services provided in [paragraph 3.1](#).

6.3.2.2 In addition to an operational authorization to use CPDLC per [paragraph 3.2](#), an operator intending to use ADS-B ITP service is required to obtain an operational authorization from the State of registry or State of the operator, in accordance with airspace and State regulatory requirements.

6.3.3 Clearance delivery and execution

6.3.3.1 When performing an ADS-B ITP supported by CPDLC, the controller should issue CPDLC clearance messages throughout the ADS-B ITP procedure, as appropriate, in response to the flight crew request. The flight crew should respond appropriately to the CPDLC clearance messages and ensure conformance to its clearance. [Table 6-4](#) provides procedural guidance for delivering and executing an ADS-B ITP clearance using CPDLC.

Table 6-4. ADS-B ITP clearance delivery and execution

Who	Procedures												
Flight crew Step 1 – requests clearance	<p>The flight crew should check if the ITP criteria are met.</p> <p><i>Note.— The display of surrounding traffic enhances flight crew awareness.</i></p> <p>If the ITP criteria are met, then to request a climb or descent to a specified flight level, the flight crew should send a CPDLC downlink message containing:</p> <p>a) DM 9 REQUEST CLIMB TO [level] or DM 10 REQUEST DESCENT TO [level], as appropriate; and</p> <p>b) One of the following free text message elements, depending on the number and the position of the reference aircraft, to convey traffic information to the controller:</p> <table border="1" data-bbox="381 709 1386 1297"> <thead> <tr> <th data-bbox="381 709 808 793">Number and relative position of reference aircraft</th> <th data-bbox="808 709 1386 793">Free Text content</th> </tr> </thead> <tbody> <tr> <td data-bbox="381 793 808 877">1 reference aircraft (ahead)</td> <td data-bbox="808 793 1386 877">DM 67a ITP [distance] BEHIND [aircraft identification]</td> </tr> <tr> <td data-bbox="381 877 808 961">1 reference aircraft (behind)</td> <td data-bbox="808 877 1386 961">DM 67r ITP [distance] AHEAD OF [aircraft identification]</td> </tr> <tr> <td data-bbox="381 961 808 1066">2 reference aircraft (both ahead)</td> <td data-bbox="808 961 1386 1066">DM 67s ITP [distance] BEHIND [aircraft identification] AND [distance] BEHIND [aircraft identification]</td> </tr> <tr> <td data-bbox="381 1066 808 1171">2 reference aircraft (both behind)</td> <td data-bbox="808 1066 1386 1171">DM 67t ITP [distance] AHEAD OF [aircraft identification] AND [distance] AHEAD OF [aircraft identification]</td> </tr> <tr> <td data-bbox="381 1171 808 1297">2 reference aircraft (one ahead and one behind)</td> <td data-bbox="808 1171 1386 1297">DM 67ag ITP [distance] BEHIND [aircraft identification] AND [distance] AHEAD OF [aircraft identification]</td> </tr> </tbody> </table> <p><i>Note 1.— [distance] is an integer value followed by NM and represents the ITP distance from the reference aircraft identified in the request.</i></p> <p><i>Note 2.— [aircraft identification] is defined by ICAO PANS ATM, item 7 of the flight plan (i.e. 2 to 7 characters).</i></p> <p>Example of a request for an ADS-B ITP climb clearance:</p> <p>DM 9 REQUEST CLIMB TO FL360</p> <p>DM 67ag ITP 25NM BEHIND SIA228 AND 21NM AHEAD OF AFR008</p>	Number and relative position of reference aircraft	Free Text content	1 reference aircraft (ahead)	DM 67a ITP [distance] BEHIND [aircraft identification]	1 reference aircraft (behind)	DM 67r ITP [distance] AHEAD OF [aircraft identification]	2 reference aircraft (both ahead)	DM 67s ITP [distance] BEHIND [aircraft identification] AND [distance] BEHIND [aircraft identification]	2 reference aircraft (both behind)	DM 67t ITP [distance] AHEAD OF [aircraft identification] AND [distance] AHEAD OF [aircraft identification]	2 reference aircraft (one ahead and one behind)	DM 67ag ITP [distance] BEHIND [aircraft identification] AND [distance] AHEAD OF [aircraft identification]
Number and relative position of reference aircraft	Free Text content												
1 reference aircraft (ahead)	DM 67a ITP [distance] BEHIND [aircraft identification]												
1 reference aircraft (behind)	DM 67r ITP [distance] AHEAD OF [aircraft identification]												
2 reference aircraft (both ahead)	DM 67s ITP [distance] BEHIND [aircraft identification] AND [distance] BEHIND [aircraft identification]												
2 reference aircraft (both behind)	DM 67t ITP [distance] AHEAD OF [aircraft identification] AND [distance] AHEAD OF [aircraft identification]												
2 reference aircraft (one ahead and one behind)	DM 67ag ITP [distance] BEHIND [aircraft identification] AND [distance] AHEAD OF [aircraft identification]												

Who	Procedures												
Controller Step 2 – issues clearance	<p>If the parameters contained in the ITP request (i.e. number of reference aircraft and distance) and the aircraft information available to the controller (e.g. surrounding traffic and differential Mach) are within the allowance for the ITP procedure, then to issue a vertical clearance for the ITP request, the controller should send a CPDLC uplink message containing:</p> <p>a) One of the free text message elements (in the table that follows), depending on the number and the position of the reference aircraft, to convey traffic information to the flight crew; and, as a minimum,</p> <p>b) UM 20 CLIMB TO [level] or <i>CLIMB TO AND MAINTAIN [altitude]</i>, or UM 23 DESCEND TO [level] or <i>DESCEND TO AND MAINTAIN [altitude]</i>, as appropriate.</p> <table border="1" data-bbox="381 709 1421 1335"> <thead> <tr> <th data-bbox="381 709 836 831">Number and relative position of reference aircraft</th> <th data-bbox="836 709 1421 831">Free Text content</th> </tr> </thead> <tbody> <tr> <td data-bbox="381 831 836 915">1 reference aircraft (ahead)</td> <td data-bbox="836 831 1421 915">UM 169ac ITP BEHIND [aircraft identification]</td> </tr> <tr> <td data-bbox="381 915 836 999">1 reference aircraft (behind)</td> <td data-bbox="836 915 1421 999">UM 169ad ITP AHEAD OF [aircraft identification]</td> </tr> <tr> <td data-bbox="381 999 836 1104">2 reference aircraft (both ahead)</td> <td data-bbox="836 999 1421 1104">UM 169ae ITP BEHIND [aircraft identification] AND BEHIND [aircraft identification]</td> </tr> <tr> <td data-bbox="381 1104 836 1220">2 reference aircraft (both behind)</td> <td data-bbox="836 1104 1421 1220">UM 169af ITP AHEAD OF [aircraft identification] AND AHEAD OF [aircraft identification]</td> </tr> <tr> <td data-bbox="381 1220 836 1335">2 reference aircraft (one ahead and one behind)</td> <td data-bbox="836 1220 1421 1335">UM 169al ITP BEHIND [aircraft identification] AND AHEAD OF [aircraft identification]</td> </tr> </tbody> </table> <p><i>Note 1.— Depending on the operational context, the free text message element may be combined with:</i></p> <p>a) UM 26 CLIMB TO REACH [level] BY [time] or UM 27 CLIMB TO REACH [level] BY [position] instead of UM 20; or</p> <p>b) UM 28 DESCEND TO REACH [level] BY [time] or UM 29 DESCEND TO REACH [level] BY [position] instead of UM 23.</p> <p><i>Note 2.— The message may also include other message elements such as UM 129 REPORT MAINTAINING [level] or REPORT LEVEL [altitude].</i></p>	Number and relative position of reference aircraft	Free Text content	1 reference aircraft (ahead)	UM 169ac ITP BEHIND [aircraft identification]	1 reference aircraft (behind)	UM 169ad ITP AHEAD OF [aircraft identification]	2 reference aircraft (both ahead)	UM 169ae ITP BEHIND [aircraft identification] AND BEHIND [aircraft identification]	2 reference aircraft (both behind)	UM 169af ITP AHEAD OF [aircraft identification] AND AHEAD OF [aircraft identification]	2 reference aircraft (one ahead and one behind)	UM 169al ITP BEHIND [aircraft identification] AND AHEAD OF [aircraft identification]
Number and relative position of reference aircraft	Free Text content												
1 reference aircraft (ahead)	UM 169ac ITP BEHIND [aircraft identification]												
1 reference aircraft (behind)	UM 169ad ITP AHEAD OF [aircraft identification]												
2 reference aircraft (both ahead)	UM 169ae ITP BEHIND [aircraft identification] AND BEHIND [aircraft identification]												
2 reference aircraft (both behind)	UM 169af ITP AHEAD OF [aircraft identification] AND AHEAD OF [aircraft identification]												
2 reference aircraft (one ahead and one behind)	UM 169al ITP BEHIND [aircraft identification] AND AHEAD OF [aircraft identification]												

Who	Procedures
	<p>Example of ADS-B ITP climb clearance message:</p> <p>UM 169aI ITP BEHIND SIA228 AND AHEAD OF AFR008</p> <p>UM 20 CLIMB TO FL360 or <i>CLIMB TO AND MAINTAIN FL360</i></p> <p>UM 129 REPORT MAINTAINING FL360 or <i>REPORT LEVEL FL360</i></p> <p>Example of ADS-B ITP descent clearance message:</p> <p>UM 169aI ITP BEHIND SIA228 AND AHEAD OF AFR008</p> <p>UM 28 DESCEND TO REACH FL320 BY 1234Z</p>
Controller Step 2 – unable to issue clearance	<p>If for any reason the clearance requested by the flight crew is not available, the controller should respond to the request by sending UM 0 UNABLE.</p> <p>The ADS-B ITP is terminated.</p> <p>If an intermediate flight level is available, the controller may send UM 169av SEND NEW ITP REQUEST IF ABLE [level]), where level can be more than one level.</p> <p><i>Note.— The flight crew will return to Step 1.</i></p>
Flight crew Step 3 – responds to clearance	<p>Upon receipt of the ADS-B ITP clearance, the flight crew should assess the clearance (in accordance with applicable standards and regulations taking into account the provisions of Chapter 5).</p> <p>If the ADS-B ITP criteria are still met, the flight crew should respond to the ADS-B ITP clearance with DM 0 WILCO message and perform the vertical manoeuvre accordingly.</p> <p>If the ADS-B ITP criteria are no longer met, the flight crew should respond to the ADS-B ITP clearance with DM 1 UNABLE.</p>

Chapter 7. State aircraft data link operations

7.1 General

7.1.1 The data link and voice communication requirements for CNS/ATM are being defined by international, regional, and national civil aviation authorities and are based on use of commercial communication systems. In airspace where procedural separation is being applied, data link has seen increased use and is normally used as the means of communication. The military has unique requirements insofar as using CPDLC. These requirements were never considered when the CPDLC message set was being developed.

7.1.2 Many air and maritime air forces have the capability to conduct air-to-air refueling (AAR) operations. Although detailed procedures are dependent on aircraft type, mode of employment and national requirements, there is sufficient commonality for standard procedures to be developed to enhance operational interoperability. Many of these air and maritime air forces are making the transition to aeronautical data links and the use of controller pilot data link communications (CPDLC) and automatic dependent surveillance - contract (ADS-C).

7.1.3 The procedures outlined below describe the communications to be utilized by military aircraft in the attempt to promote harmonization in CPDLC and ADS-C procedures. These procedures have been developed utilizing a combination of existing CPDLC message elements and standardized free text. Standardized free text messages have been created to support these military operations in the attempt to avoid the general use of free text messages and for overall standardization. To the maximum extent possible, data link capable aircraft should adhere to procedural guidelines provided in [Chapter 5](#) and [Chapter 6](#).

7.1.4 The aim of this chapter is to provide a reference document covering military procedures to be used in an aeronautical data link environment. This chapter will provide guidance for the flight crew and the ANSP to promote harmonized military AAR operations in an aeronautical data link environment and lead to a better understanding of AAR procedures and terminology.

7.2 Military assumes responsibility for separation of aircraft (MARSA)

7.2.1 Prior to commencing AAR or maneuvers with receiver aircraft, the tanker will notify ATC that the military assumes responsibility for separation of aircraft (MARSA). The tanker will use the term, MARSA, to notify ATC that the tanker and receiver aircraft are accepting the responsibility for their actions within the AAR route and the tanker is the lead of the formation. ATC controls all other traffic to preclude conflicts between civil and military traffic involved in the AAR while at the same time still controlling the tanker and receiver. The actual refueling commences at the air refueling control point (ARCP) and continues as the aircraft proceed down the refueling route. Normally, the refueling is completed prior to the aircraft reaching the air refueling exit point (AREX) point. At AREX, both aircraft need to receive ATC clearances to continue on their filed routing.

Table 7-1. MARSAs initiation and termination procedures

Who	Procedures
Flight crew (Tanker) (Step 1)	<p>a) The tanker can initiate MARSAs after it receives clearance for the block level/altitude and, optionally, reports passing the ARCP. The tanker informs the controller that the flight crew is accepting MARSAs procedures with the receiver.</p> <p>DM 67z ACCEPT MARSAs WITH [call sign(s) of receiver aircraft]</p> <p>where [receiver aircraft call sign(s)] exactly matches the filed flight plan(s) for the receiver aircraft.</p> <hr/> <p>b) The tanker performs MARSAs with receiver aircraft.</p>
Flight crew (Tanker and Receiver) (Step 2)	<p>To terminate MARSAs, each aircraft should first notify the controller of their assigned level/altitude.</p> <p>DM 37 MAINTAINING [level] or LEVEL [altitude]</p>
Controller (to Tanker) (Step 3)	<p>Then, when the controller receives notification that each aircraft is at its assigned level/altitude, the controller sends a free text message to terminate MARSAs between the tanker and the receiver aircraft.</p> <p>UM 169aq MARSAs TERMINATED WITH [call sign(s) of receiver aircraft]</p> <p>MARSAs is terminated when the tanker receives notification.</p>

7.3 Air-to-air refueling (AAR)

7.3.1 Air-to-air refueling is normally accomplished between 10,000 and 28,000 feet depending on receiver type, requiring both aircraft to descent for refueling.

7.3.2 Refueling routes are numbered and depicted on charts used in airspace where ATS surveillance services are being provided and a few are depicted on charts used in airspace where procedural separation is being applied. Refueling may also be conducted on non-designated routes with an altitude reservation (ALTRV). In all cases, the refueling procedure is part of the filed flight plan. The flight plan always includes time, requested block level/altitude, air refueling control point (ARCP), air refueling initial point (ARIP), air refueling exit point (AREX) and intermediate refueling route points. If the procedure is depicted, its designation (ARxxx) is sufficient to define the route. In a procedurally controlled environment, a refueling pattern may be part of an existing ALTRV.

7.3.3 During the refueling phase all aircraft operate within the block level/altitude and fly the route along the refueling route in the flight plan. An ADS contract may be set with any aircraft but it is only necessary with the lead tanker and needs to correspond with a filed flight plan. Additionally, any other CPDLC report (i.e. **UM 130** REPORT PASSING [position], etc.) may be requested of the tanker in order to track the progress of the flight. The aircraft may or may not remain in a single formation in the

block level/altitude for the remainder of the flight. There are no special CPDLC messages developed during this phase.

7.3.4 A typical air-refueling pattern is illustrated in [Figure 7-1](#). The light green route represents the tanker's intended route to the ARCP. The light blue route is the receiver's intended route. Both aircraft file separate flight plans showing the specific aerial refueling locations. The dark blue route is the tanker's orbit and rendezvous flight paths with the dark green route depicting the AAR route. Three or more points can define the AAR route. The ARIP is the point where the receiver enters the AAR route. The ARCP is the reference point for the holding pattern where the tanker awaits the receiver. The AAR route is between the ARCP and the AREX.

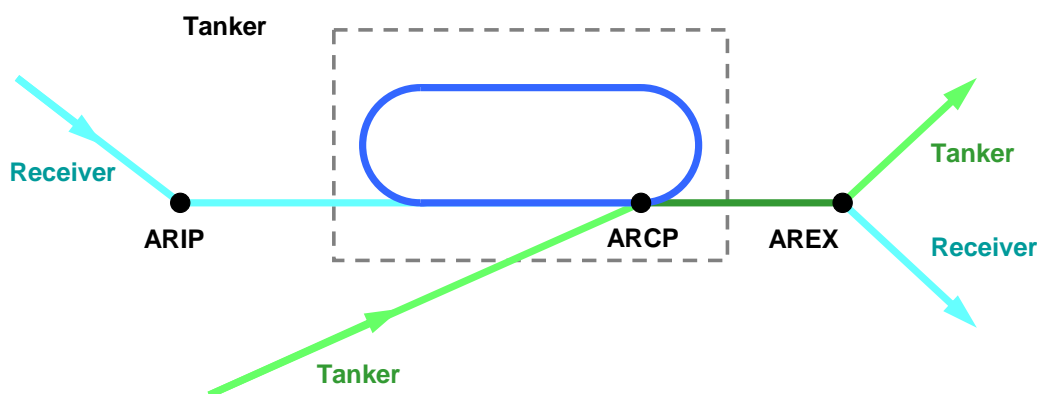

Figure 7-1. Air refueling pattern

Table 7-2. Air refueling data link procedures

Who	Procedures
Flight crew (Tanker) (Step 1)	<p>At approximately 10 minutes from the ARCP, the tanker requests a clearance to delay at the ARCP until the rendezvous with the receiver and request a block level/altitude for air refueling.</p> <p>DM 25 REQUEST CLEARANCE</p> <p>DM 67w TO DELAY FOR AIR REFUEL AT [position] UNTIL [time]</p> <p>DM 7 REQUEST BLOCK [level] TO [level]</p> <p>Where:</p> <p>[position] is the ARCP as filed in the tanker's flight plan.</p> <p>[time] is the time the tanker expects to pass the ARCP and commence refueling along the refueling route. It is also the end of the delay time.</p>

Who	Procedures
Controller (to Tanker) (Step 2)	<p>a) The controller clears the tanker to delay at the ARCP, as requested. <u>UM 169ar</u> CLEARED TO DELAY FOR AIR REFUEL AT [position] UNTIL [time] <i>Note.— This message may need to be appended with a “free text” message in the event the controller needs to specify a specific area of operations or if the area to delay is different than the filed flight plan.</i></p> <p>b) If block level/altitude is available, the controller issues one of the following instructions: <u>UM 31</u> CLIMB TO AND MAINTAIN BLOCK [level] TO [level]; or <u>UM 32</u> DESCEND TO AND MAINTAIN BLOCK [level] TO [level]; or <u>UM 30</u> MAINTAIN BLOCK [level] TO [level]. Optionally, the controller may append the following: <u>UM 180</u> REPORT REACHING BLOCK [level] TO [level]; and/or <u>UM 130</u> REPORT PASSING [position]</p> <p>c) If the block level/altitude clearance is not available, the controller issues the following: <u>UM 0</u> UNABLE <u>UM 166</u> DUE TO TRAFFIC Optionally, the controller may append the following: <u>UM 19</u> MAINTAIN [level], then any one of the following <u>UM 9</u> or <u>UM 10</u> EXPECT DESCENT AT [position/time]; or <u>UM 7</u> or <u>UM 8</u> EXPECT CLIMB AT [position/time]. Optionally, the controller may request a report. <u>UM 130</u> REPORT PASSING [position].</p>
Flight crew (Tanker) (Step 3)	<p>The tanker responds to the controller instructions in accordance with the guidance provided in <u>paragraph 2.2.5.4</u>. <u>DM 0</u> WILCO; <u>DM 1</u> UNABLE; <u>DM 3</u> ROGER; or <u>DM 2</u> STANDBY.</p>

Who	Procedures
Flight crew (Tanker) (Step 4)	<p>If ATC has instructed the aircraft to report passing the ARCP, then when the tanker crosses the ARCP, the flight crew notifies the controller that it has crossed the ARCP and has entered the air-refueling orbit.</p> <p>DM 31 PASSING [position]</p>
Controller (to Tanker) (Step 5)	<p>If block level/altitude was NOT previously available, when traffic permits, the controller issues the block level/altitude clearance for the tanker.</p> <p>UM 31 CLIMB TO AND MAINTAIN BLOCK [level] TO [level]; or</p> <p>UM 32 DESCEND TO AND MAINTAIN BLOCK [level] TO [level]; or</p> <p>UM 30 MAINTAIN BLOCK [level] TO [level].</p> <p>Optionally, the controller may append the following:</p> <p>UM 180 REPORT REACHING BLOCK [level] TO [level].</p>
Flight crew (Tanker) (Step 6)	<p>The tanker responds to the controller instructions in accordance with the guidance provided in paragraph 2.2.5.4.</p> <p>DM 0 WILCO;</p> <p>DM 1 UNABLE;</p> <p>DM 3 ROGER; or</p> <p>DM 2 STANDBY.</p>
Flight crew (Tanker) (Step 7)	<p>When the receiver approaches the ARIP, the tanker informs the controller that the flight crew is accepting MARSAs with the receiver.</p> <p>DM 67z ACCEPT MARSAs WITH [call sign(s) of receiver aircraft]</p> <p>where [call sign(s) of receiver aircraft] exactly matches the filed flight plan(s) for the receiver aircraft.</p>
Flight crew (Receiver(s)) (Step 8)	<p>Prior to entering the ARIP – ARCP route, each receiver aircraft requests a level/altitude change to conduct refueling.</p> <p>DM 7 REQUEST BLOCK [level] TO [level]</p>

Who	Procedures
Controller (to Receiver(s)) (Step 9)	<p>a) If the controller has received the MARSAs message from the tanker, the controller clears the receiver(s) to operate in the block level/altitude required for refueling.</p> <p><i>Note.— If the controller did not receive the MARSAs message from the tanker, the controller would UNABLE any requests from the receiver(s) until MARSAs could be confirmed.</i></p> <p>UM 31 CLIMB TO AND MAINTAIN BLOCK [level] TO [level]; or UM 32 DESCEND TO AND MAINTAIN BLOCK [level] TO [level]; or UM 30 MAINTAIN BLOCK [level] TO [level]; and UM 169as CLEARED TO CONDUCT REFUELING.</p> <p>Optionally, the controller may append the following: UM 180 REPORT REACHING BLOCK [level] TO [level].</p>
Controller (to Tanker)	<p>b) The controller clears the tanker for refueling.</p> <p>UM 169 CLEARED TO CONDUCT REFUELING.</p>
Flight crew (Tanker and Receiver) (Step 10)	<p>The tanker and receiver respond to the controller instructions in accordance with the guidance provided in paragraph 2.2.5.4.</p> <p>DM 0 WILCO; DM 1 UNABLE; DM 3 ROGER; or DM 2 STANDBY.</p>
Flight crew (Tanker and Receiver) (Step 11)	<p>When the tanker is commencing the rendezvous with the receiver, each aircraft sends the following:</p> <p>DM 11 AT [position] REQUEST CLIMB TO [level]; or DM 12 AT [position] REQUEST DESCENT TO [level];</p> <p>Where: [position] is the EXIT point; and [level] is the requested level for each aircraft after refueling is complete.</p>
Flight crew (Tanker) (Step 12)	<p>When approaching the end of refueling, the tanker notifies the controller when to expect the end of refueling.</p> <p>DM 67x EXPECT END OF REFUEL AT [time/position].</p>

Who	Procedures
Controller (to Tanker and Receiver) (Step 13)	<p>The controller issues instructions to assign different flight levels/altitudes to each of the aircraft upon completion of refueling.</p> <p>UM 164 WHEN READY; and</p> <p>UM 19 MAINTAIN [level]; and</p> <p>UM 129 REPORT MAINTAINING [level] or <i>REPORT LEVEL [altitude]</i></p> <p><i>Note.</i>— <i>Climb or descent clearances may be issued as appropriate.</i></p>
Flight crew (Tanker and Receiver) (Step 14)	<p>a) The tanker and receiver respond to the controller instructions in accordance with the guidance provided in paragraph 2.2.5.4.</p> <p>DM 0 WILCO;</p> <p>DM 1 UNABLE;</p> <p>DM 3 ROGER; or</p> <p>DM 2 STANDBY.</p> <hr/> <p>b) When the aircraft is maintaining the assigned level, each aircraft notifies the controller.</p> <p>DM 37 MAINTAINING [level] or <i>LEVEL [altitude]</i></p>
Controller (to Tanker) (Step 15)	<p>When the controller receives notification that each aircraft is at its assigned level/altitude, the controller sends a free text message to terminate MARSAs between the tanker and the receiver aircraft.</p> <p>UM 169aq MARSAs TERMINATED WITH [call sign(s) of receiver aircraft]</p>

7.4 Formation flight data link procedures

7.4.1 Formation flying in a standard formation is usually one in which a proximity of no more than 1 mile laterally or longitudinally and within 100 feet vertically from the flight leader is maintained by each aircraft. Non-standard formations are those operating under conditions other than standard formation dimensions that the flight leader has requested and air traffic control (ATC) has approved, or when operating within an authorized ALTRV.

7.4.2 For each flight plan, the lead aircraft will initiate a logon at the correct time (refer to **paragraph 5.2.2**). Once in formation, only the lead aircraft will make position reports in accordance **paragraph 5.6**. Use CPDLC standard messages for level/altitude requests, routing requests (if different from what was filed), and speed or ETA requests with ATC to effect any en-route changes.

7.4.3 In the event a formation wants to break-up the formation or depart an ALTRV the aircraft desiring to break off of the formation will coordinate their departure a minimum of ten (10) minutes prior

to separation with appropriate requests, and the following data link procedures will be used. Air traffic control will need separate flight plans for each flight in the event that the formation splits.

Table 7-3. Single aircraft or formation joining an ALTRV data link procedures

Who	Procedures
Flight crew	<p>When a single aircraft or formation is joining an ALTRV, the flight crew notifies the controller of its intention to join the formation.</p> <p>DM 67y JOINING ALTRV [ALTRV designator] AT [time/position]</p> <p>Example: JOINING ALTRV CW413 AT HEMLO or JOINING ALTRV CW413 AT 1530Z</p>

Table 7-4. Formation break-up or departure from ALTRV data link procedures

Who	Procedures
Controller	<p>ATC responds to the request.</p> <p>UM 74 PROCEED DIRECT TO [position]; or</p> <p>UM 76 AT [time] PROCEED DIRECT TO [position]; or</p> <p>UM 77 AT [position] PROCEED DIRECT TO [position]; or</p> <p>UM 79 CLEARED TO [position] VIA [route clearance]; or</p> <p>UM 80 CLEARED [route clearance]; or</p> <p>UM 83 AT [position] CLEARED [route clearance]</p>
Flight crew	<p>The flight crew responds to the controller instructions in accordance with the guidance provided in paragraph 2.2.5.4.</p> <p>DM 0 WILCO;</p> <p>DM 1 UNABLE;</p> <p>DM 3 ROGER; or</p> <p>DM 2 STANDBY.</p>
Flight crew or Controller	<p>The flight crew may further request desired level/altitude and the controller would respond with the appropriate instructions.</p>

7.5 ADS-C reports

7.5.1 If suitably equipped, State aircraft should ensure ADS-C is armed because ADS contracts may be established by ATC. ATC will establish ADS contracts with the lead aircraft as identified in the filed flight plan.

Appendix A CPDLC message elements and standardized free text messages

A.1 General

A.1.1 This appendix contains the CPDLC message elements and standardized and preformatted free text messages for the FANS 1/A, ATN B1, and ATN B1-FANS 1/A data link systems described in paragraph 2.1.2. The CPDLC message elements are based on ICAO Doc 4444, 15th Edition.

- [Section A.2](#) provides a CPDLC message element response requirements key;
- [Section A.3](#) provides the CPDLC uplink message elements and intended uses;
- [Section A.4](#) provides the CPDLC downlink message elements; and
- [Section A.5](#) provides CPDLC standardized free text messages.

A.1.2 The following guidelines apply:

a) Normal text is taken from ICAO Doc 4444 (e.g. message response key or message intent/use) and represents the global baseline. *Italic text* supplements the ICAO Doc 4444 guideline either as a *Note* or specific to *FANS 1/A*, *ATN B1*, or *ATN B1-FANS 1/A* data link system.

b) In cases where there is a choice for the message element or the response attribute, the first choice that appears in the row for that message element is shown in **bold text** and indicates the preferred choice, per ICAO Doc 4444, and should be used for new implementations. The second choice is shown in *italic text* and indicates legacy implementations (e.g. FANS 1/A), that are considered acceptable.

c) The following variables are considered operationally interchangeable in this document respecting range and resolution variations as defined in interoperability standards:

ICAO Doc 4444 variable	Equivalent FANS 1/A variable
[level]	[altitude] (<i>See Note</i>)
[specified distance] [direction]	[distance offset] [direction]
[departure clearance]	[predeparture clearance]
[unit name]	[icao unit name]
[code]	[beacon code]
[facility designation]	[icao facility designation]
[persons on board]	[remaining souls]

Note.— ICAO Doc 4444 notes that message elements that contain the [level] variable can be specified as either a single level or a vertical range (i.e. block level). **FANS 1/A** only considers the [level] variable as a single level and uses message elements that are intended exclusively for specifying a vertical range (e.g. [UM 30](#), [UM 31](#), [UM 32](#), [UM 180](#), [DM 7](#), [DM 76](#), [DM 77](#), etc). **ATN B1** uses the [level] variable to specify a vertical range and does not use the message elements intended exclusively for specifying a vertical range, except in cases where an ATN B1 ground system provides data link service to FANS 1/A aircraft.

d) The “CPDLC message set” column indicates which of the CPDLC message sets, FANS 1/A, ATN B1 or FANS 1/A-ATN B1, supports the message element. The cell is shaded **green** if they are valid messages in the ICAO Doc 4444 message set and **red** if they are reserved.

1) If a CPDLC message set supports a message element that is reserved in ICAO Doc 4444, then the cell will be **red** and the data link system will be highlighted in **green**. In these cases, the ANSPs and operators should establish procedures or automation to avoid the use of these message elements.

2) In some cases, a CPDLC message set supports a message element that is also a valid message element in ICAO Doc 4444, but its use should be avoided due to potential misinterpretation. In these cases, a note has been added to the “Message intent/use” column, and the ANSPs and operators should establish procedures or automation to avoid the use of these message elements.

3) *N/A* in this column indicates that none of the CPDLC message sets support the message element.

e) The CPDLC message set in use will depend on the aircraft system and ground system capabilities and is shown as follows:

Ground systems	Aircraft systems (See Note 2)	CPDLC message set (See Note 1)
FANS 1/A	FANS 1/A	FANS 1/A
FANS 1/A	FANS 1/A-ATN B1	FANS 1/A
FANS 1/A	ATN B1	N/A
ATN B1	FANS 1/A	N/A
ATN B1	FANS 1/A-ATN B1	ATN B1
ATN B1	ATN B1	ATN B1
FANS 1/A-ATN B1	FANS 1/A	FANS 1/A-ATN B1
FANS 1/A-ATN B1	ATN B1	ATN B1
FANS 1/A-ATN B1	FANS 1/A-ATN B1	ATN B1 or FANS 1/A-ATN B1
<p><i>Note 1.— The FANS 1/A-ATN B1 message set provides the ground system the equivalent of an ATN B1 message set for FANS 1/A aircraft, either through the use of UM 183 and UM 169 [free text] or other message elements that are operationally equivalent, except UM 215, UM 190, UM 227 and UM 196 are not supported.</i></p> <p><i>Note 2.— A FANS 1/A-ATN B1 aircraft system fully supports FANS 1/A and ATN B1 CPDLC message sets.</i></p>		

Note.— The FOREWORD suggests that this guidance material may contain material that may eventually become Standards and Recommended Practices (SARPs), or PANS provisions. In particular, ICAO should strongly consider appropriate changes where experience has shown that valid message elements should be avoided, as indicated in this appendix.

A.2 CPDLC message element response requirements key

Response column	Description
	For uplink message
W/U	<p>Response required. Yes</p> <p>Valid responses. WILCO, UNABLE, STANDBY, NOT CURRENT DATA AUTHORITY, NOT AUTHORIZED NEXT DATA AUTHORITY, LOGICAL ACKNOWLEDGEMENT (only if required), ERROR</p> <p><i>Note.</i>— WILCO, UNABLE, NOT CURRENT DATA AUTHORITY, NOT AUTHORIZED NEXT DATA AUTHORITY and ERROR will close the uplink message.</p> <p><i>FANS I/A.</i>— WILCO, UNABLE, STANDBY, ERROR, NOT CURRENT DATA AUTHORITY.</p>
A/N	<p>Response required. Yes</p> <p>Valid responses. AFFIRM, NEGATIVE, STANDBY, NOT CURRENT DATA AUTHORITY, NOT AUTHORIZED NEXT DATA AUTHORITY, LOGICAL ACKNOWLEDGEMENT (only if required), ERROR</p> <p><i>Note.</i>— AFFIRM, NEGATIVE, NOT CURRENT DATA AUTHORITY, NOT AUTHORIZED NEXT DATA AUTHORITY and ERROR will close the uplink message.</p> <p><i>FANS I/A.</i>— AFFIRM, NEGATIVE, STANDBY, ERROR, NOT CURRENT DATA AUTHORITY.</p>
R	<p>Response required. Yes</p> <p>Valid responses. ROGER, UNABLE, STANDBY, NOT CURRENT DATA AUTHORITY, NOT AUTHORIZED NEXT DATA AUTHORITY, LOGICAL ACKNOWLEDGEMENT (only if required), ERROR</p> <p><i>Note.</i>— ROGER, NOT CURRENT DATA AUTHORITY, NOT AUTHORIZED NEXT DATA AUTHORITY and ERROR will close the uplink message.</p> <p><i>FANS I/A.</i>— ROGER, STANDBY, ERROR, NOT CURRENT DATA AUTHORITY. <i>FANS I/A aircraft do not have the capability to send UNABLE in response to an uplink message containing message elements with an “R” response attribute. For these aircraft, the flight crew may use alternative means to UNABLE the message. These alternative means will need to be taken into consideration to ensure proper technical and operational closure of the communication transaction.</i></p>
Y	<p>Response required. Yes</p> <p>Valid responses: Any CPDLC downlink message, LOGICAL ACKNOWLEDGEMENT (only if required)</p>
N	<p>Response required. No, unless logical acknowledgement required.</p> <p>Valid Responses (only if LOGICAL ACKNOWLEDGEMENT is required). LOGICAL ACKNOWLEDGEMENT, NOT CURRENT DATA AUTHORITY, NOT AUTHORIZED NEXT DATA AUTHORITY, ERROR</p> <p><i>FANS I/A.</i>— Defined “Response not required,” but not used. Under some circumstances, an ERROR message will also close an uplink message.</p>

Response column	Description
NE	[Not defined in ICAO Doc 4444] <i>FANS 1/A.— The WILCO, UNABLE, AFFIRM, NEGATIVE, ROGER, and STANDBY responses are not enabled (NE) for flight crew selection. An uplink message with a response attribute NE is considered to be closed even though a response may be required operationally. Under some circumstances, a downlink error message may be linked to an uplink message with a NE attribute.</i>
	For downlink messages
Y	Response required. Yes Valid responses. Any CPDLC uplink message, LOGICAL ACKNOWLEDGEMENT (only if required).
N	Response required. No, unless logical acknowledgement required. Valid responses (only if LOGICAL ACKNOWLEDGEMENT is required). LOGICAL ACKNOWLEDGEMENT, SERVICE UNAVAILABLE, FLIGHT PLAN NOT HELD, ERROR <i>FANS 1/A.— Aircraft do not have the capability to receive technical responses to downlink message elements with an “N” response attribute (other than LACK or ERROR for ATN B1 aircraft). In some cases, the response attribute is different between FANS 1/A aircraft and ICAO Doc 4444. As an example, most emergency messages have an “N” response attribute for FANS 1/A whereas ICAO Doc 4444 defines a “Y” response attribute for them. As a consequence, for FANS 1/A aircraft, the ATC will need to use alternative means to acknowledge to the flight crew that an emergency message has been received.</i>

A.3 CPDLC uplink message elements

Ref #	Message Intent/Use	Message Element	Resp.	Data link system(s)
	Responses/Acknowledgements (uplink)			
UM 0	Indicates that ATC cannot comply with the request.	UNABLE	N or NE	FANS 1/A ATN B1 FANS 1/A- ATN B1
UM 1	Indicates that ATC has received the message and will respond. <i>Note.— The flight crew is informed that the request is being assessed and there will be a <u>short-term delay</u> (e.g. as appropriate, given the situation, but not to exceed 10 minutes). The exchange is not closed and the request will be responded to when conditions allow.</i>	STANDBY	N or NE	FANS 1/A ATN B1 FANS 1/A- ATN B1

Ref #	Message Intent/Use	Message Element	Resp.	Data link system(s)
UM 2	Indicates that ATC has received the request but it has been deferred until later. <i>Note.</i> — <i>The flight crew is informed that the request is being assessed and a long-term delay can be expected. The exchange is not closed and the request will be responded to when conditions allow.</i>	REQUEST DEFERRED	N or NE	FANS 1/A
UM 3	Indicates that ATC has received and understood the message.	ROGER	N or NE	FANS 1/A ATN B1 FANS 1/A- ATN B1
UM 4	Yes.	AFFIRM	N or NE	FANS 1/A ATN B1 FANS 1/A- ATN B1
UM 5	No	NEGATIVE	N or NE	FANS 1/A ATN B1 FANS 1/A- ATN B1
UM 235	Notification of receipt of unlawful interference message.	ROGER 7500	N	N/A (Urgent)
UM 211	Indicates that the ATC has received the request and has passed it to the next control authority. <i>FANS 1/A and FANS 1/A-ATN B1.</i> — <i>Uses UM 169x free text for FANS 1/A aircraft.</i>	REQUEST FORWARDED	N	FANS 1/A [free text] ATN B1 FANS 1/A- ATN B1
UM 218	Indicates to the pilot that the request has already been received on the ground.	REQUEST ALREADY RECEIVED	N	N/A
UM 237	Indicates that the request cannot be responded to by the current unit and that it should be requested from the next unit. <i>FANS 1/A and FANS 1/A-ATN B1.</i> — <i>Uses UM 169ab free text for FANS 1/A aircraft.</i>	REQUEST AGAIN WITH NEXT UNIT	N	FANS 1/A [free text] ATN B1 FANS 1/A- ATN B1
	Vertical Clearances (uplink)			
UM 6	Notification that a level change instruction should be expected. <i>Note.</i> — <i>Avoid use of this message element due to potential misinterpretation.</i>	EXPECT [level]	R	FANS 1/A

Ref #	Message Intent/Use	Message Element	Resp.	Data link system(s)
UM 7	Notification that an instruction should be expected for the aircraft to commence climb at the specified time. <i>Note.— The controller should only use this message to respond to a flight crew request (e.g. WHEN CAN WE EXPECT).</i>	EXPECT CLIMB AT [time]	R	FANS 1/A
UM 8	Notification that an instruction should be expected for the aircraft to commence climb at the specified position. <i>Note.— The controller should only use this message to respond to a flight crew request (e.g. WHEN CAN WE EXPECT).</i>	EXPECT CLIMB AT [position]	R	FANS 1/A
UM 9	Notification that an instruction should be expected for the aircraft to commence descent at the specified time. <i>Note.— The controller should only use this message to respond to a flight crew request (e.g. WHEN CAN WE EXPECT).</i>	EXPECT DESCENT AT [time]	R	FANS 1/A
UM 10	Notification that an instruction should be expected for the aircraft to commence descent at the specified position. <i>Note.— The controller should only use this message to respond to a flight crew request (e.g. WHEN CAN WE EXPECT).</i>	EXPECT DESCENT AT [position]	R	FANS 1/A
UM 11	Notification that an instruction should be expected for the aircraft to commence cruise climb at the specified time. <i>Note.— Avoid use of this message element due to potential misinterpretation.</i>	EXPECT CRUISE CLIMB AT [time]	R	FANS 1/A
UM 12	Notification that an instruction should be expected for the aircraft to commence cruise climb at the specified position. <i>Note.— Avoid use of this message element due to potential misinterpretation.</i>	EXPECT CRUISE CLIMB AT [position]	R	FANS 1/A
UM 13	(Reserved) <i>Note.— Avoid use of this message element, AT [time] EXPECT CLIMB TO [altitude], as it is reserved in ICAO Doc 4444.</i>	N/A	R	FANS 1/A

Ref #	Message Intent/Use	Message Element	Resp.	Data link system(s)
UM 14	(Reserved) <i>Note.</i> — Avoid use of this message element, AT [position] EXPECT CLIMB TO [altitude], as it is reserved in ICAO Doc 4444.	N/A	R	FANS 1/A
UM 15	(Reserved) <i>Note.</i> — Avoid use of this message element, AT [time] EXPECT DESCENT TO [altitude], as it is reserved in ICAO Doc 4444.	N/A	R	FANS 1/A
UM 16	(Reserved) <i>Note.</i> — Avoid use of this message element, AT [position] EXPECT DESCENT TO [altitude], as it is reserved in ICAO Doc 4444.	N/A	R	FANS 1/A
UM 17	(Reserved) <i>Note.</i> — Avoid use of this message element, AT [time] EXPECT CRUISE CLIMB TO [altitude], as it is reserved in ICAO Doc 4444.	N/A	R	FANS 1/A
UM 18	(Reserved) <i>Note.</i> — Avoid use of this message element, AT [position] EXPECT CRUISE CLIMB TO [altitude], as it is reserved in ICAO Doc 4444.	N/A	R	FANS 1/A
UM 19	Instruction to maintain the specified level.	MAINTAIN [level]	W/U	FANS 1/A ATN B1 FANS 1/A- ATN B1
UM 20	Instruction that a climb to a specified level is to commence and once reached the specified level is to be maintained.	CLIMB TO [level] or <i>CLIMB TO AND MAINTAIN [altitude]</i>	W/U	FANS 1/A ATN B1 FANS 1/A- ATN B1

Ref #	Message Intent/Use	Message Element	Resp.	Data link system(s)
UM 21	<p>Instruction that at the specified time a climb to the specified level is to commence and once reached the specified level is to be maintained.</p> <p><i>Note 1.— Instruction that NOT BEFORE the specified time, a climb to the specified level is to commence and once reached the specified level is to be maintained.</i></p> <p><i>Note 2.— Precede this message element with UM 19 MAINTAIN [level], to prevent the premature execution of the instruction.</i></p>	AT [time] CLIMB TO [level] or <i>AT [time] CLIMB TO AND MAINTAIN [altitude]</i>	W/U	FANS 1/A
UM 22	<p>Instruction that at the specified position a climb to the specified level is to commence and once reached the specified level is to be maintained.</p> <p><i>Note 1.— Instruction that AFTER PASSING the specified position, a climb to the specified level is to commence and once reached the specified level is to be maintained.</i></p> <p><i>Note 2.— Precede this message element with UM 19 MAINTAIN [level], to prevent the premature execution of the instruction.</i></p>	AT [position] CLIMB TO [level] or <i>AT [position] CLIMB TO AND MAINTAIN [altitude]</i>	W/U	FANS 1/A
UM 185	(Reserved)	N/A	W/U	N/A
UM 23	<p>Instruction that a descent to a specified level is to commence and once reached the specified level is to be maintained.</p>	DESCEND TO [level] or <i>DESCEND TO AND MAINTAIN [altitude]</i>	W/U	FANS 1/A ATN B1 FANS 1/A- ATN B1

Ref #	Message Intent/Use	Message Element	Resp.	Data link system(s)
UM 24	<p>Instruction that at a specified time a descent to a specified level is to commence and once reached the specified level is to be maintained.</p> <p><i>Note 1.— Instruction that NOT BEFORE the specified time, a descent to the specified level is to commence, and once reached, the specified level is to be maintained.</i></p> <p><i>Note 2.— Precede this message element with UM 19 MAINTAIN [level], to prevent the premature execution of the instruction.</i></p>	<p>AT [time] DESCEND TO [level] or <i>AT [time] DESCEND TO AND MAINTAIN [altitude]</i></p>	W/U	FANS 1/A
UM 25	<p>Instruction that at the specified position a descent to the specified level is to commence and once reached the specified level is to be maintained.</p> <p><i>Note 1.— Instruction that AFTER PASSING the specified position, a descent to the specified level is to commence and once reached the specified level is to be maintained.</i></p> <p><i>Note 2.— Precede this message element with UM 19 MAINTAIN [level], to prevent the premature execution of the instruction.</i></p>	<p>AT [position] DESCEND TO [level] or <i>AT [position] DESCEND TO AND MAINTAIN [altitude]</i></p>	W/U	FANS 1/A
UM 186	(Reserved)	N/A	W/U	N/A
UM 26	<p>Instruction that a climb is to commence at a rate such that the specified level is reached at or before the specified time. When this message element is not concatenated with another vertical clearance, the level specified is the assigned level which is to be maintained.</p> <p><i>Note.— Instruction that a climb is to commence at a rate such that the specified level is reached NOT LATER THAN the specified time.</i></p>	<p>CLIMB TO REACH [level] BY [time]</p>	W/U	FANS 1/A ATN B1 FANS 1/A- ATN B1

Ref #	Message Intent/Use	Message Element	Resp.	Data link system(s)
UM 27	<p>Instruction that a climb is to commence at a rate such that the specified level is reached at or before the specified position. When this message element is not concatenated with another vertical clearance, the level specified is the assigned level which is to be maintained.</p> <p><i>Note.</i>— <i>Instruction that a climb is to commence at a rate such that the specified level is reached BEFORE PASSING the specified position.</i></p>	CLIMB TO REACH [level] BY [position]	W/U	FANS 1/A ATN B1 FANS 1/A- ATN B1
UM 28	<p>Instruction that a descent is to commence at a rate such that the specified level is reached at or before the specified time. When this message element is not concatenated with another vertical clearance, the level specified is the assigned level which is to be maintained.</p> <p><i>Note.</i>— <i>Instruction that a descent is to commence at a rate such that the specified level is reached NOT LATER THAN the specified time.</i></p>	DESCEND TO REACH [level] BY [time]	W/U	FANS 1/A ATN B1 FANS 1/A- ATN B1
UM 29	<p>Instruction that a descent is to commence at a rate such that the specified level is reached at or before the specified position. When this message element is not concatenated with another vertical clearance, the level specified is the assigned level which is to be maintained.</p> <p><i>Note.</i>— <i>Instruction that a descent is to commence at a rate such that the specified level is reached BEFORE PASSING the specified position.</i></p>	DESCEND TO REACH [level] BY [position]	W/U	FANS 1/A ATN B1 FANS 1/A- ATN B1
UM 192	<p>Instruction that a change of level is to continue, but at a rate such that the specified level is reached at or before the specified time.</p>	REACH [level] BY [time]	W/U	N/A
UM 209	<p>Instruction that a change of level is to continue, but at a rate such that the specified level is reached at or before the specified position.</p>	REACH [level] BY [position]	W/U	N/A

Ref #	Message Intent/Use	Message Element	Resp.	Data link system(s)
UM 30	Instruction that a level within the defined vertical range specified is to be maintained. <i>FANS 1/A-ATN B1.</i> — <i>FANS 1/A aircraft only. ATN B1 aircraft accepts UM 19 MAINTAIN [level], where [level] is a vertical range.</i>	MAINTAIN BLOCK [level] TO [level]	W/U	FANS 1/A FANS 1/A- ATN B1
UM 31	Instruction that a climb to a level within the vertical range defined is to commence. <i>FANS 1/A-ATN B1.</i> — <i>FANS 1/A aircraft only. ATN B1 aircraft accepts UM 20 CLIMB TO [level], where [level] is a vertical range.</i>	CLIMB TO AND MAINTAIN BLOCK [level] TO [level]	W/U	FANS 1/A FANS 1/A- ATN B1
UM 32	Instruction that a descent to a level within the vertical range defined is to commence. <i>FANS 1/A-ATN B1.</i> — <i>FANS 1/A aircraft only. ATN B1 aircraft accepts UM 23 DESCEND TO [level], where [level] is a vertical range.</i>	DESCEND TO AND MAINTAIN BLOCK [level] TO [level]	W/U	FANS 1/A FANS 1/A- ATN B1
UM 34	Instruction that a cruise climb to the specified level is to commence and continue and, once reached the specified level is to be maintained. <i>Note.</i> — <i>Avoid use of this message element due to potential misinterpretation.</i>	CRUISE CLIMB TO [level]	W/U	FANS 1/A
UM 35	Instruction to be used in conjunction with an associated level instruction indicating that a cruise climb can commence once above the specified level. <i>Note.</i> — <i>Avoid use of this message element due to potential misinterpretation.</i>	WHEN ABOVE (level) COMMENCE CRUISE CLIMB or <i>CRUISE CLIMB ABOVE [level]</i>	W/U	FANS 1/A
UM 219	Instruction to stop the climb at the specified level and, once reached, this level is to be maintained. The specified level will be below the previously assigned level.	STOP CLIMB AT [level]	W/U	N/A (Urgent)
UM 220	Instruction to stop the descent at the specified level and, once reached, this level is to be maintained. The specified level will be above the previously assigned level.	STOP DESCENT AT [level]	W/U	N/A (Urgent)

Ref #	Message Intent/Use	Message Element	Resp.	Data link system(s)
UM 36	Instruction that the climb to the specified level should be made at the aircraft's best rate.	EXPEDITE CLIMB TO [level]	W/U	FANS 1/A
UM 37	Instruction that the descent to the specified level should be made at the aircraft's best rate.	EXPEDITE DESCENT TO [level]	W/U	FANS 1/A
UM 38	Urgent instruction to immediately climb to the specified level and, once reached, the specified level is to be maintained.	IMMEDIATELY CLIMB TO [level]	W/U	FANS 1/A (Distress)
UM 39	Urgent instruction to immediately descend to the specified level and, once reached, the specified level is to be maintained.	IMMEDIATELY DESCEND TO [level]	W/U	FANS 1/A (Distress)
UM 40	(Reserved) <i>Note.— Avoid use of this message element, IMMEDIATELY STOP CLIMB AT [altitude], as it is reserved in ICAO Doc 4444.</i>	(Not defined)	Y or W/U	FANS 1/A
UM 41	(Reserved) <i>Note.— Avoid use of this message element, IMMEDIATELY STOP DESCENT AT [altitude], as it is reserved in ICAO Doc 4444.</i>	(Not defined)	Y or W/U	FANS 1/A
UM 171	Instruction to climb at not less than the specified rate.	CLIMB AT [vertical rate] MINIMUM	W/U	FANS 1/A ATN B1 FANS 1/A- ATN B1
UM 172	Instruction to climb at not above the specified rate.	CLIMB AT [vertical rate] MAXIMUM	W/U	FANS 1/A ATN B1 FANS 1/A- ATN B1
UM 173	Instruction to descend at not less than the specified rate.	DESCEND AT [vertical rate] MINIMUM	W/U	FANS 1/A ATN B1 FANS 1/A- ATN B1
UM 174	Instruction to descend at not above the specified rate.	DESCEND AT [vertical rate] MAXIMUM	W/U	FANS 1/A ATN B1 FANS 1/A- ATN B1

Ref #	Message Intent/Use	Message Element	Resp.	Data link system(s)
UM 33	(Reserved) <i>Note.</i> — Avoid use of this message element, <i>CRUISE</i> [altitude], as it is reserved in ICAO Doc 4444.	(Not defined)	Y or W/U	FANS 1/A
Crossing Constraints (uplink)				
UM 42	(Reserved) <i>Note.</i> — Avoid use of this message element, <i>EXPECT TO CROSS</i> [position] <i>AT</i> [altitude], as it is reserved in ICAO Doc 4444.	N/A	R	FANS 1/A
UM 43	(Reserved) <i>Note.</i> — Avoid use of this message element, <i>EXPECT TO CROSS</i> [position] <i>AT OR ABOVE</i> [altitude], as it is reserved in ICAO Doc 4444.	N/A	R	FANS 1/A
UM 44	(Reserved) <i>Note.</i> — Avoid use of this message element, <i>EXPECT TO CROSS</i> [position] <i>AT OR BELOW</i> [altitude], as it is reserved in ICAO Doc 4444.	N/A	R	FANS 1/A
UM 45	(Reserved) <i>Note.</i> — Avoid use of this message element, <i>EXPECT TO CROSS</i> [position] <i>AT AND MAINTAIN</i> [altitude], as it is reserved in ICAO Doc 4444.	N/A	R	FANS 1/A
UM 46	Instruction that the specified position is to be crossed at the specified level. This may require the aircraft to modify its climb or descent profile.	CROSS [position] AT [level]	W/U	FANS 1/A ATN B1 FANS 1/A- ATN B1
UM 47	Instruction that the specified position is to be crossed at or above the specified level.	CROSS [position] AT OR ABOVE [level]	W/U	FANS 1/A ATN B1 FANS 1/A- ATN B1
UM 48	Instruction that the specified position is to be crossed at or below the specified level.	CROSS [position] AT OR BELOW [level]	W/U	FANS 1/A ATN B1 FANS 1/A- ATN B1
UM 49	Instruction that the specified position is to be crossed at the specified level and that level is to be maintained when reached.	CROSS [position] AT AND MAINTAIN [level]	W/U	FANS 1/A

Ref #	Message Intent/Use	Message Element	Resp.	Data link system(s)
UM 50	Instruction that the specified position is to be crossed at a level between the specified levels.	CROSS [position] BETWEEN [level] AND [level]	W/U	FANS 1/A
UM 51	Instruction that the specified position is to be crossed at the specified time.	CROSS [position] AT [time]	W/U	FANS 1/A ATN B1 FANS 1/A- ATN B1
UM 52	Instruction that the specified position is to be crossed at or before the specified time.	CROSS [position] AT OR BEFORE [time]	W/U	FANS 1/A ATN B1 FANS 1/A- ATN B1
UM 53	Instruction that the specified position is to be crossed at or after the specified time.	CROSS [position] AT OR AFTER [time]	W/U	FANS 1/A ATN B1 FANS 1/A- ATN B1
UM 54	Instruction that the specified position is to be crossed at a time between the specified times.	CROSS [position] BETWEEN [time] AND [time]	W/U	FANS 1/A ATN B1 FANS 1/A- ATN B1
UM 55	Instruction that the specified position is to be crossed at the specified speed and the specified speed is to be maintained until further advised.	CROSS [position] AT [speed]	W/U	FANS 1/A ATN B1 FANS 1/A- ATN B1
UM 56	Instruction that the specified position is to be crossed at a speed equal to or less than the specified speed and the specified speed or less is to be maintained until further advised.	CROSS [position] AT OR LESS THAN [speed]	W/U	FANS 1/A
UM 57	Instruction that the specified position is to be crossed at a speed equal to or greater than the specified speed and the specified speed or greater is to be maintained until further advised.	CROSS [position] AT OR GREATER THAN [speed]	W/U	FANS 1/A
UM 58	Instruction that the specified position is to be crossed at the specified time and the specified level.	CROSS [position] AT [time] AT [level]	W/U	FANS 1/A
UM 59	Instruction that the specified position is to be crossed at or before the specified time and at the specified level.	CROSS [position] AT OR BEFORE [time] AT [level]	W/U	FANS 1/A

Ref #	Message Intent/Use	Message Element	Resp.	Data link system(s)
UM 60	Instruction that the specified position is to be crossed at or after the specified time and at the specified level.	CROSS [position] AT OR AFTER [time] AT [level]	W/U	FANS 1/A
UM 61	Instruction that the specified position is to be crossed at the specified level and speed, and the level and speed are to be maintained.	CROSS [position] AT AND MAINTAIN [level] AT [speed]	W/U	FANS 1/A ATN B1 FANS 1/A- ATN B1
UM 62	Instruction that at the specified time the specified position is to be crossed at the specified level and the level is to be maintained.	AT [time] CROSS [position] AT AND MAINTAIN [level]	W/U	FANS 1/A
UM 63	Instruction that at the specified time the specified position is to be crossed at the specified level and speed, and the level and speed are to be maintained.	AT [time] CROSS [position] AT AND MAINTAIN [level] AT [speed]	W/U	FANS 1/A
	Lateral Offsets (uplink)			
UM 64	Instruction to fly a parallel track to the cleared route at a displacement of the specified distance in the specified direction.	OFFSET [specified distance] [direction] OF ROUTE	W/U	FANS 1/A ATN B1 FANS 1/A- ATN B1
UM 65	Instruction to fly a parallel track to the cleared route at a displacement of the specified distance in the specified direction and commencing at the specified position.	AT [position] OFFSET [specified distance] [direction] OF ROUTE	W/U	FANS 1/A
UM 66	Instruction to fly a parallel track to the cleared route at a displacement of the specified distance in the specified direction and commencing at the specified time.	AT [time] OFFSET [specified distance] [direction] OF ROUTE	W/U	FANS 1/A
UM 67	Instruction that the cleared flight route is to be rejoined.	PROCEED BACK ON ROUTE	W/U	FANS 1/A
UM 68	Instruction that the cleared flight route is to be rejoined at or before the specified position.	REJOIN ROUTE BY [position]	W/U	FANS 1/A
UM 69	Instruction that the cleared flight route is to be rejoined at or before the specified time.	REJOIN ROUTE BY [time]	W/U	FANS 1/A

Ref #	Message Intent/Use	Message Element	Resp.	Data link system(s)
UM 70	Notification that a clearance may be issued to enable the aircraft to rejoin the cleared route at or before the specified position.	EXPECT BACK ON ROUTE BY [position]	R	FANS 1/A
UM 71	Notification that a clearance may be issued to enable the aircraft to rejoin the cleared route at or before the specified time.	EXPECT BACK ON ROUTE BY [time]	R	FANS 1/A
UM 72	Instruction to resume own navigation following a period of tracking or heading clearances. May be used in conjunction with an instruction on how or where to rejoin the cleared route.	RESUME OWN NAVIGATION	W/U	FANS 1/A ATN B1 FANS 1/A- ATN B1
Route Modifications (uplink)				
UM 73	Instruction to be followed from departure until the specified clearance limit.	[departure clearance]	W/U	FANS 1/A
UM 74	Instruction to proceed directly from its present position to the specified position.	PROCEED DIRECT TO [position]	W/U	FANS 1/A ATN B1 FANS 1/A- ATN B1
UM 75	Instruction to proceed, when able, directly to the specified position.	WHEN ABLE PROCEED DIRECT TO [position]	W/U	FANS 1/A
UM 76	Instruction to proceed, at the specified time, directly to the specified position.	AT [time] PROCEED DIRECT TO [position]	W/U	FANS 1/A
UM 77	Instruction to proceed, at the specified position, directly to the next specified position.	AT [position] PROCEED DIRECT TO [position]	W/U	FANS 1/A
UM 78	Instruction to proceed, upon reaching the specified level, directly to the specified position.	AT [level] PROCEED DIRECT TO [position]	W/U	FANS 1/A
UM 79	Instruction to proceed to the specified position via the specified route.	CLEARED TO [position] VIA [route clearance]	W/U	FANS 1/A ATN B1 FANS 1/A- ATN B1
UM 80	Instruction to proceed via the specified route.	CLEARED [route clearance]	W/U	FANS 1/A ATN B1 FANS 1/A- ATN B1
UM 81	Instruction to proceed in accordance with the specified procedure.	CLEARED [procedure name]	W/U	FANS 1/A

Ref #	Message Intent/Use	Message Element	Resp.	Data link system(s)
UM 236	Instruction to leave controlled airspace.	LEAVE CONTROLLED AIRSPACE	W/U	N/A
UM 82	Approval to deviate up to the specified distance from the cleared route in the specified direction.	CLEARED TO DEVIATE UP TO [specified distance] [direction] OF ROUTE	W/U	FANS 1/A ATN B1 FANS 1/A- ATN B1
UM 83	Instruction to proceed from the specified position via the specified route.	AT [position] CLEARED [route clearance]	W/U	FANS 1/A
UM 84	Instruction to proceed from the specified position via the specified procedure.	AT [position] CLEARED [procedure name]	W/U	FANS 1/A
UM 85	Notification that a clearance to fly on the specified route may be issued. <i>Note.</i> — Avoid use of this message element due to potential misinterpretation.	EXPECT [route clearance]	R	FANS 1/A
UM 86	Notification that a clearance to fly on the specified route from the specified position may be issued. <i>Note.</i> — Avoid use of this message element due to potential misinterpretation.	AT [position] EXPECT [route clearance]	R	FANS 1/A
UM 87	Notification that a clearance to fly directly to the specified position may be issued. <i>Note.</i> — Avoid use of this message element due to potential misinterpretation.	EXPECT DIRECT TO [position]	R	FANS 1/A
UM 88	Notification that a clearance to fly directly from the first specified position to the next specified position may be issued. <i>Note.</i> — Avoid use of this message element due to potential misinterpretation.	AT [position] EXPECT DIRECT TO [position]	R	FANS 1/A
UM 89	Notification that a clearance to fly directly to the specified position commencing at the specified time may be issued. <i>Note.</i> — Avoid use of this message element due to potential misinterpretation.	AT [time] EXPECT DIRECT TO [position]	R	FANS 1/A
UM 90	Notification that a clearance to fly directly to the specified position commencing when the specified level is reached may be issued. <i>Note.</i> — Avoid use of this message element due to potential misinterpretation.	AT [level] EXPECT DIRECT TO [position]	R	FANS 1/A

Ref #	Message Intent/Use	Message Element	Resp.	Data link system(s)
UM 91	Instruction to enter a holding pattern with the specified characteristics at the specified position and level.	HOLD AT [position] MAINTAIN [level] INBOUND TRACK [degrees] [direction] URNS [leg type] or <i>HOLD AT [position]</i> <i>MAINTAIN [altitude]</i> <i>INBOUND TRACK</i> <i>[degrees][direction] TURN</i> <i>LEG TIME [leg type]</i>	W/U	FANS 1/A
UM 92	Instruction to enter a holding pattern with the published characteristics at the specified position and level.	HOLD AT [position] AS PUBLISHED MAINTAIN [level]	W/U	FANS 1/A ATN B1 FANS 1/A- ATN B1
UM 93	Notification that an onwards clearance may be issued at the specified time.	EXPECT FURTHER CLEARANCE AT [time]	R	FANS 1/A
UM 94	Instruction to turn left or right as specified on to the specified heading.	TURN [direction] HEADING [degrees]	W/U	FANS 1/A ATN B1 FANS 1/A- ATN B1
UM 95	Instruction to turn left or right as specified on to the specified track.	TURN [direction] GROUND TRACK [degrees]	W/U	FANS 1/A
UM 215	Instruction to turn a specified number of degrees left or right.	TURN [direction] [degrees] DEGREES	W/U	ATN B1 FANS 1/A- ATN B1
UM 190	Instruction to fly on the specified heading.	FLY HEADING [degrees]	W/U	ATN B1 FANS 1/A- ATN B1
UM 96	Instruction to continue to fly on the current heading.	CONTINUE PRESENT HEADING or FLY <i>PRESENT HEADING</i>	W/U	FANS 1/A ATN B1 FANS 1/A- ATN B1
UM 97	Instruction to fly on the specified heading from the specified position.	AT [position] FLY HEADING [degrees]	W/U	FANS 1/A
UM 221	Instruction to stop turn at the specified heading prior to reaching the previously assigned heading.	STOP TURN HEADING [degrees]	W/U	N/A (Urgent)
UM 98	Instruction to turn immediately left or right as specified on to the specified heading.	IMMEDIATELY TURN [direction] HEADING [degrees]	W/U	FANS 1/A (Distress)

Ref #	Message Intent/Use	Message Element	Resp.	Data link system(s)
UM 99	Notification that a clearance may be issued for the aircraft to fly the specified procedure.	EXPECT [procedure name]	R	FANS 1/A
	Speed Changes (uplink)			
UM 100	Notification that a speed instruction may be issued to be effective at the specified time.	AT [time] EXPECT [speed]	R	FANS 1/A
UM 101	Notification that a speed instruction may be issued to be effective at the specified position.	AT [position] EXPECT [speed]	R	FANS 1/A
UM 102	Notification that a speed instruction may be issued to be effective at the specified level. <i>Note.</i> — Avoid use of this message element due to potential misinterpretation.	AT [level] EXPECT [speed]	R	FANS 1/A
UM 103	Notification that a speed range instruction may be issued to be effective at the specified time. <i>Note.</i> — Avoid use of this message element due to potential misinterpretation.	AT [time] EXPECT [speed] TO [speed]	R	FANS 1/A
UM 104	Notification that a speed range instruction may be issued to be effective at the specified position. <i>Note.</i> — Avoid use of this message element due to potential misinterpretation.	AT [position] EXPECT [speed] TO [speed]	R	FANS 1/A
UM 105	Notification that a speed range instruction may be issued to be effective at the specified level. <i>Note.</i> — Avoid use of this message element due to potential misinterpretation.	AT [level] EXPECT [speed] TO [speed]	R	FANS 1/A
UM 106	Instruction that the specified speed is to be maintained.	MAINTAIN [speed]	W/U	FANS 1/A ATN B1 FANS 1/A- ATN B1
UM 188	Instruction that after passing the specified position the specified speed is to be maintained.	AFTER [position] PASSING [speed] MAINTAIN	W/U	N/A
UM 107	Instruction that the present speed is to be maintained.	MAINTAIN PRESENT SPEED	W/U	FANS 1/A ATN B1 FANS 1/A- ATN B1

Ref #	Message Intent/Use	Message Element	Resp.	Data link system(s)
UM 108	Instruction that the specified speed or a greater speed is to be maintained.	MAINTAIN [speed] OR GREATER	W/U	FANS 1/A ATN B1 FANS 1/A- ATN B1
UM 109	Instruction that the specified speed or a lesser speed is to be maintained.	MAINTAIN [speed] OR LESS	W/U	FANS 1/A ATN B1 FANS 1/A- ATN B1
UM 110	Instruction that a speed within the specified range is to be maintained.	MAINTAIN [speed] TO [speed]	W/U	FANS 1/A
UM 111	Instruction that the present speed is to be increased to the specified speed and maintained until further advised.	INCREASE SPEED TO [speed]	W/U	FANS 1/A
UM 112	Instruction that the present speed is to be increased to the specified speed or greater, and maintained at or above the specified speed until further advised.	INCREASE SPEED TO [speed] OR GREATER	W/U	FANS 1/A
UM 113	Instruction that the present speed is to be reduced to the specified speed and maintained until further advised.	REDUCE SPEED TO [speed]	W/U	FANS 1/A
UM 114	Instruction that the present speed is to be reduced to the specified speed or less and maintained at or below the specified speed until further advised.	REDUCE SPEED TO [speed] OR LESS	W/U	FANS 1/A
UM 115	Instruction that the specified speed is not to be exceeded.	DO NOT EXCEED [speed]	W/U	FANS 1/A
UM 116	Instruction that the aircraft's normal speed be resumed. The previously issued speed restriction(s) are cancelled.	RESUME NORMAL SPEED	W/U	FANS 1/A ATN B1 FANS 1/A- ATN B1
UM 189	Instruction that the present speed is to be changed to the specified speed.	ADJUST SPEED TO [speed]	W/U	N/A
UM 222	Notification that the aircraft may keep its preferred speed without restriction. <i>FANS 1/A and FANS 1/A-ATN B1.— Uses <u>UM 169z</u>, free text for FANS 1/A aircraft.</i>	NO RESTRICTION SPEED	R	FANS 1/A [free text] ATN B1 FANS 1/A- ATN B1
UM 223	Instruction to reduce present speed to the minimum safe approach speed.	REDUCE TO MINIMUM APPROACH SPEED	W/U	N/A

Ref #	Message Intent/Use	Message Element	Resp.	Data link system(s)
	Contact/Monitor/Surveillance Requests (uplink)			
UM 117	Instruction that the ATS unit with the specified ATS unit name is to be contacted on the specified frequency.	CONTACT [unit name] [frequency]	W/U	FANS 1/A ATN B1 FANS 1/A- ATN B1
UM 118	Instruction that at the specified position the ATS unit with the specified ATS unit name is to be contacted on the specified frequency.	AT [position] CONTACT [unit name] [frequency]	W/U	FANS 1/A
UM 119	Instruction that at the specified time the ATS unit with the specified ATS unit name is to be contacted on the specified frequency.	AT [time] CONTACT [unit name] [frequency]	W/U	FANS 1/A
UM 238	Notification that the secondary frequency is as specified. <i>FANS 1/A.— Uses UM 169o free text for FANS 1/A aircraft.</i>	SECONDARY FREQUENCY [frequency]	R	FANS 1/A [free text]
UM 120	Instruction that the ATS unit with the specified ATS unit name is to be monitored on the specified frequency. <i>Note.— The flight crew is not required to check in.</i>	MONITOR [unit name] [frequency]	W/U	FANS 1/A ATN B1 FANS 1/A- ATN B1
UM 121	Instruction that at the specified position the ATS unit with the specified ATS unit name is to be monitored on the specified frequency. <i>Note.— The flight crew is not required to check in.</i>	AT [position] MONITOR [unit name] [frequency]	W/U	FANS 1/A
UM 122	Instruction that at the specified time the ATS unit with the specified ATS unit name is to be monitored on the specified frequency. <i>Note.— The flight crew is not required to check in.</i>	AT [time] MONITOR [unit name] [frequency]	W/U	FANS 1/A
UM 123	Instruction that the specified code (SSR code) is to be selected.	SQUAWK [code]	W/U	FANS 1/A ATN B1 FANS 1/A- ATN B1
UM 124	Instruction that the SSR transponder responses are to be disabled.	STOP SQUAWK	W/U	FANS 1/A

Ref #	Message Intent/Use	Message Element	Resp.	Data link system(s)
UM 239	Instruction that the ADS-B transmissions are to be terminated.	STOP ADS-B TRANSMISSION	W/U	N/A
UM 125	Instruction that the SSR transponder responses should include level information.	SQUAWK MODE CHARLIE or <i>SQUAWK ALTITUDE</i>	W/U	FANS 1/A
UM 240	Instruction that the ADS-B transmissions should include level information.	TRANSMIT ADS-B ALTITUDE	W/U	N/A
UM 126	Instruction that the SSR transponder responses should no longer include level information.	STOP SQUAWK MODE CHARLIE or <i>STOP ALTITUDE SQUAWK</i>	W/U	FANS 1/A
UM 241	Instruction that the ADS-B transmissions should no longer include level information.	STOP ADS-B ALTITUDE TRANSMISSION	W/U	N/A
UM 179	Instruction that the ‘ident’ function on the SSR transponder is to be actuated.	SQUAWK IDENT	W/U	FANS 1/A ATN B1 FANS 1/A- ATN B1
UM 242	Instruction that the “ident” function of the ADS-B emitter is to be activated. <i>FANS 1/A.— Uses UM 169ai free text for FANS 1/A aircraft. The free text message is considered acceptable as the intended use does not change the volume of protected airspace (i.e. not a clearance).</i>	TRANSMIT ADS-B IDENT	W/U or <i>R (free text)</i>	FANS 1/A [free text]
UM 243	Instruction to report when the aircraft is clear of adverse meteorological conditions, and a clearance to regain cleared flight route can be accepted.	REPORT CLEAR OF WEATHER	W/U	N/A
	Report/Confirmation Requests (uplink)			
UM 127	Instruction to report when the aircraft is back on the cleared route.	REPORT BACK ON ROUTE	W/U or <i>R</i>	FANS 1/A
UM 128	Instruction to report when the aircraft has vacated the specified level that has either been maintained or passed through on climb or descent. <i>Note.— Either a level that has been maintained, or a level passed through on climb or descent.</i>	REPORT LEAVING [level]	W/U or <i>R</i>	FANS 1/A

Ref #	Message Intent/Use	Message Element	Resp.	Data link system(s)
UM 129	Instruction to report when the aircraft is in level flight at the specified level. <i>Note.</i> — <i>This message element is only to be used with single altitude clearances.</i>	REPORT MAINTAINING [level] or REPORT LEVEL [altitude]	W/U or R	FANS 1/A
UM 175	(Reserved) <i>Note.</i> — <i>Avoid use of this message element, REPORT REACHING [level], as it is reserved in ICAO Doc 4444.</i>	N/A	W/U or R	FANS 1/A
UM 200	Instruction used in conjunction with a level clearance to report maintaining the level assigned.	REPORT MAINTAINING	W/U	N/A
UM 180	Instruction to report when the aircraft is within the specified vertical range.	REPORT REACHING BLOCK [level] TO [level]	W/U or R	FANS 1/A
UM 130	Instruction to report when the aircraft has passed the specified position.	REPORT PASSING [position]	W/U or R	FANS 1/A
UM 181	Instruction to report the present distance to or from the specified position.	REPORT DISTANCE [to/from] [position]	Y or NE	FANS 1/A
UM 184	Instruction to report at the specified time the distance to or from the specified position.	AT TIME [time] REPORT DISTANCE [to/from] [position]	Y	N/A
UM 228	Instruction to report the estimated time of arrival at the specified position. <i>FANS 1/A.</i> — <i>Uses UM 169d free text for FANS 1/A aircraft.</i>	REPORT ETA [position]	Y DM 104	FANS 1/A [free text]
UM 131	Instruction to report the amount of fuel remaining and the number of persons on board.	REPORT REMAINING FUEL AND PERSONS ON BOARD or REPORT REMAINING FUEL AND SOULS ON BOARD	Y or NE	FANS 1/A (Urgent)
UM 132	Instruction to report the present position.	REPORT POSITION or CONFIRM POSITION	Y or NE	FANS 1/A

Ref #	Message Intent/Use	Message Element	Resp.	Data link system(s)
UM 133	Instruction to report the present level.	REPORT PRESENT LEVEL or CONFIRM ALTITUDE	Y or NE <u>DM 32</u>	FANS 1/A ATN B1 FANS 1/A- ATN B1
UM 134	Instruction to report the requested speed. <i>Note.</i> — <i>Instruction to report the present speed.</i> <i>FANS 1/A.</i> — Uses <u>UM 169b</u> free text for <i>FANS 1/A</i> aircraft when the controller is requesting the flight crew to report the present ground speed.	REPORT [speed type] [speed type] [speed type] SPEED or CONFIRM SPEED	Y or NE or R <u>DM 113</u>	FANS 1/A [free text]
UM 135	Instruction to confirm the currently assigned level.	CONFIRM ASSIGNED LEVEL or CONFIRM ASSIGNED ALTITUDE	Y or NE <u>DM 38</u> <u>DM 77</u> (TBC)	FANS 1/A ATN B1 FANS 1/A- ATN B1
UM 136	Instruction to confirm the currently assigned speed.	CONFIRM ASSIGNED SPEED	Y or NE	FANS 1/A
UM 137	Instruction to confirm the currently assigned route.	CONFIRM ASSIGNED ROUTE	Y or NE	FANS 1/A
UM 138	Instruction to confirm the previously reported time over the last reported waypoint.	CONFIRM TIME OVER REPORTED WAYPOINT	Y or NE	FANS 1/A
UM 139	Instruction to confirm the identity of the previously reported waypoint.	CONFIRM REPORTED WAYPOINT	Y or NE	FANS 1/A
UM 140	Instruction to confirm the identity of the next waypoint.	CONFIRM NEXT WAYPOINT	Y or NE	FANS 1/A
UM 141	Instruction to confirm the previously reported estimated time at the next waypoint.	CONFIRM NEXT WAYPOINT ETA	Y or NE	FANS 1/A

Ref #	Message Intent/Use	Message Element	Resp.	Data link system(s)
UM 142	Instruction to confirm the identity of the next but one waypoint.	CONFIRM ENSUING WAYPOINT	Y or NE	FANS 1/A
UM 143	The request was not understood. It should be clarified and resubmitted.	CONFIRM REQUEST	Y or NE	FANS 1/A
UM 144	Instruction to report the selected (SSR) code.	CONFIRM SQUAWK	Y or NE	FANS 1/A
UM 145	Instruction to report the present heading.	REPORT HEADING or <i>CONFIRM HEADING</i>	Y or NE	FANS 1/A
UM 146	Instruction to report the present ground track.	REPORT GROUND TRACK or <i>CONFIRM GROUND TRACK</i>	Y or NE	FANS 1/A
UM 182	Instruction to report the identification code of the last ATIS received.	CONFIRM ATIS CODE	Y or NE	FANS 1/A
UM 147	Instruction to make a position report. <i>Note.— To be used if the controller does not receive a scheduled position report.</i>	REQUEST POSITION REPORT	Y or NE	FANS 1/A
UM 216	Instruction to file a flight plan.	REQUEST FLIGHT PLAN	Y	N/A
UM 217	Instruction to report that the aircraft has landed.	REPORT ARRIVAL	Y	N/A
UM 229	Instruction to report the preferred alternate aerodrome for landing.	REPORT ALTERNATE AERODROME	Y	N/A
UM 231	Instruction to indicate the pilot's preferred level. <i>FANS 1/A and FANS 1/A-ATN B1.— uses UM 169c free text for FANS 1/A aircraft.</i>	STATE PREFERRED LEVEL	Y <i>DM 106</i>	FANS 1/A [free text] ATN B1 FANS 1/A- ATN B1
UM 232	Instruction to indicate the pilot's preferred time and/or position to commence descent to the aerodrome of intended arrival. <i>FANS 1/A and FANS 1/A-ATN B1.— Uses UM 169aa free text for FANS 1/A aircraft.</i>	STATE TOP OF DESCENT	Y <i>DM 109</i>	FANS 1/A [free text] ATN B1 FANS 1/A- ATN B1

Ref #	Message Intent/Use	Message Element	Resp.	Data link system(s)
	Negotiation Requests (uplink)			
UM 148	Request for the earliest time or position at which the specified level can be accepted.	WHEN CAN YOU ACCEPT [level]	Y or NE <u>DM 81</u> <u>DM 82</u>	FANS 1/A ATN B1 FANS 1/A- ATN B1
UM 149	Instruction to report whether or not the specified level can be accepted at the specified position.	CAN YOU ACCEPT [level] AT [position]	A/N	FANS 1/A
UM 150	Instruction to report whether or not the specified level can be accepted at the specified time.	CAN YOU ACCEPT [level] AT [time]	A/N	FANS 1/A
UM 151	Instruction to report the earliest time or position when the specified speed can be accepted.	WHEN CAN YOU ACCEPT [speed]	Y or NE <u>DM 83</u> <u>DM 84</u>	FANS 1/A
UM 152	Instruction to report the earliest time or position when the specified offset track can be accepted.	WHEN CAN YOU ACCEPT [specified distance] [direction] OFFSET	Y or NE <u>DM 85</u> <u>DM 86</u>	FANS 1/A
	Air Traffic Advisories (uplink)			
UM 153	ATS advisory that the altimeter setting should be the specified setting.	ALTIMETER [altimeter]	R	FANS 1/A
UM 213	ATS advisory that the specified altimeter setting relates to the specified facility. <i>FANS 1/A and FANS 1/A-ATN B1.— Uses <u>UM 169y</u> free text for FANS 1/A aircraft.</i>	[facility designation] ALTIMETER [altimeter]	R	FANS 1/A [free text] ATN B1 FANS 1/A- ATN B1
UM 154	ATS advisory that the radar service is terminated.	RADAR SERVICE or RADAR SERVICES TERMINATED	R	FANS 1/A

Ref #	Message Intent/Use	Message Element	Resp.	Data link system(s)
UM 244	ATS advisory that the radar and/or ADS-B service is terminated. <i>FANS I/A.— uses UM 169aj free text for FANS I/A aircraft.</i>	IDENTIFICATION TERMINATED	R	FANS I/A [free text]
UM 191	ATS advisory that the aircraft is entering airspace in which no air traffic services are provided and all existing air traffic services are terminated.	ALL ATS TERMINATED	R	N/A
UM 155	ATS advisory that radar contact has been established at the specified position.	RADAR CONTACT [position]	R	FANS I/A
UM 156	ATS advisory that radar contact has been lost.	RADAR CONTACT LOST	R	FANS I/A
UM 210	ATS advisory that the aircraft has been identified on radar and/or ADS-B at the specified position.	IDENTIFIED [position]	R	N/A
UM 193	Notification that radar and/or ADS-B identification has been lost.	IDENTIFICATION LOST	R	N/A
UM 157	Instruction that a continuous transmission is detected on the specified frequency. Check the microphone button.	CHECK STUCK MICROPHONE [frequency]	N or R	FANS I/A ATN B1 FANS I/A- ATN B1 (Urgent)
UM 158	ATS advisory that the ATIS information identified by the specified code is the current ATIS information.	ATIS [atis code]	R	FANS I/A
UM 212	ATS advisory that the specified ATIS information at the specified airport is current.	[facility designation] ATIS [atis code] CURRENT	R	N/A
UM 214	ATS advisory that indicates the RVR value for the specified runway.	RVR RUNWAY [runway] [rvr]	R	N/A
UM 224	ATS advisory that no delay is expected.	NO DELAY EXPECTED	R	N/A
UM 225	ATS advisory that the expected delay has not been determined.	DELAY NOT DETERMINED	R	N/A
UM 226	ATS advisory that the aircraft may expect to be cleared to commence its approach procedure at the specified time.	EXPECTED APPROACH TIME [time]	R	N/A

Ref #	Message Intent/Use	Message Element	Resp.	Data link system(s)
	System Management Messages (uplink)			
UM 159	A system generated message notifying that the ground system has detected an error.	ERROR [error information]	N or NE	FANS 1/A ATN B1 FANS 1/A- ATN B1 (Urgent)
UM 160	Notification to the avionics that the specified data authority is the next data authority. If no data authority is specified, this indicates that any previously specified next data authority is no longer valid.	NEXT DATA AUTHORITY [facility designation]	N or NE	FANS 1/A ATN B1 FANS 1/A- ATN B1
UM 161	Notification to the avionics that the data link connection with the current data authority is being terminated.	END SERVICE	N or NE	FANS 1/A
UM 162	Notification that the ground system does not support this message. <i>FANS 1/A and FANS 1/A ATN B1.— Uses <u>UM 169u</u> free text for FANS 1/A aircraft.</i>	MESSAGE NOT SUPPORTED BY THIS ATS UNIT or SERVICE UNAVAILABLE	N or NE	FANS 1/A [free text] ATN B1 FANS 1/A- ATN B1
UM 234	Notification that the ground system does not have a flight plan for that aircraft.	FLIGHT PLAN NOT HELD	N	N/A
UM 163	Notification to the pilot of an ATSU identifier.	[facility designation] or <i>[icao facility designation] [tP4+Table]</i>	N or NE	FANS 1/A
UM 227	Confirmation to the aircraft system that the ground system has received the message to which the logical acknowledgement refers and found it acceptable for display to the responsible person. <i>FANS 1/A-ATN B1.— ATN B1 only. Not available for FANS 1/A.</i>	LOGICAL ACKNOWLEDGEMENT	N	ATN B1 FANS 1/A- ATN B1
UM 233	Notification to the pilot that messages sent requiring a logical acknowledgement will not be accepted by this ground system.	USE OF LOGICAL ACKNOWLEDGEMENT PROHIBITED	N	N/A

Ref #	Message Intent/Use	Message Element	Resp.	Data link system(s)
	Additional Messages (uplink)			
UM 164	The associated instruction may be complied with at any future time. <i>Note.</i> — See also UM 177 AT PILOTS DISCRETION.	WHEN READY	N or NE	FANS 1/A
UM 230	The associated instruction is to be complied with immediately.	IMMEDIATELY	N	N/A (Distress)
UM 165	Used to link two messages, indicating the proper order of execution of clearances/instructions.	THEN	N or NE	FANS 1/A ATN B1 FANS 1/A- ATN B1
UM 166	The associated instruction is issued due to traffic considerations.	DUE TO [traffic type] TRAFFIC or <i>DUE TO TRAFFIC</i>	N or NE	FANS 1/A
UM 167	The associated instruction is issued due to airspace restrictions.	DUE TO AIRSPACE RESTRICTION	N or NE	FANS 1/A
UM 168	The indicated communication should be ignored. <i>Note.</i> — The previously sent uplink CPDLC message should be ignored. <i>DISREGARD</i> should not refer to a clearance or instruction. If <i>DISREGARD</i> is used, another element should be added to clarify which message is to be disregarded.	DISREGARD	R	FANS 1/A
UM 176	Instruction that the pilot is responsible for maintaining separation from other traffic and is also responsible for maintaining visual meteorological conditions.	MAINTAIN OWN SEPARATION AND VMC	W/U	FANS 1/A

Ref #	Message Intent/Use	Message Element	Resp.	Data link system(s)
UM 177	Used in conjunction with a clearance/instruction to indicate that the pilot may execute when prepared to do so. <i>Note 1.— When used in conjunction with altitude assignments, means that ATC has offered the pilot the option of starting climb or descent whenever he/she wishes and conducting the climb or descent at any rate he/she wishes. He/she may temporarily level off at any intermediate altitude. However, once he/she has vacated an altitude, he/she may not return to that altitude.</i> <i>Note 2.— There are considerable differences regarding the interpretation of “pilot’s discretion” and “when ready” and their meanings/intended uses.</i> <i>Note 3.— See also UM 164 WHEN READY.</i>	AT PILOTS DISCRETION	N	FANS 1/A
UM 178	(Reserved) <i>Note.— Avoid use of this message element, TRACK DETAIL MESSAGE, as it is reserved in ICAO Doc 4444.</i>	(not defined)	Y or W/U	FANS 1/A
	Free Text Normal-(uplink)			
UM 169	Normal urgency attribute, low alert attribute <i>FANS 1/A – ATN B1.— FANS 1/A only. Ground system uses UM 183 [free text] for ATN B1 aircraft.</i>	[free text]	R	FANS 1/A FANS 1/A- ATN B1
	Free Text Distress (uplink)			
UM 170	Distress urgency attribute, high alert attribute	[free text]	R	FANS 1/A
	Free Text – Other			
UM 183	Normal urgency attribute, medium alert attribute <i>FANS 1/A-ATN B1.— ATN B1 only. Ground system uses UM 169 [free text] for FANS 1/A aircraft.</i>	[free text]	N	ATN B1 FANS 1/A- ATN
UM 187	low urgency, normal alert	[free text]	N	N/A

Ref #	Message Intent/Use	Message Element	Resp.	Data link system(s)
UM 194	normal urgency, low alert	[free text]	Y	N/A
UM 195	low urgency, low alert	[free text]	R	N/A
UM 196	normal urgency, medium alert	[free text]	W/U	ATN B1 FANS 1/A- ATN B1
UM 197	urgent urgency, medium alert	[free text]	W/U	N/A (Urgent)
UM 198	distress urgency, high alert	[free text]	W/U	N/A (Distress)
UM 199	normal urgency, low alert	[free text]	N	N/A
UM 201	Not used, low urgency, low alert	[free text]	N	N/A
UM 202	Not used, low urgency, low alert	[free text]	N	N/A
UM 203	normal urgency, medium alert	[free text]	R	N/A
UM 204	normal urgency, medium alert	[free text]	Y	N/A
UM 205	normal urgency, medium alert	[free text]	A/N	N/A
UM 206	low urgency, normal alert	[free text]	Y	N/A
UM 207	low urgency, low alert	[free text]	Y	N/A
UM 208	low urgency, low alert	[free text]	N	N/A

A.4 CPDLC downlink message elements

Ref #	Message Intent/Use	Message Element	Resp.	Data link system(s)
	Responses/Acknowledgements (downlink)			
DM 0	The instruction is understood and will be complied with.	WILCO	N	FANS 1/A ATN B1 FANS 1/A- ATN B1
DM 1	The instruction cannot be complied with.	UNABLE	N	FANS 1/A ATN B1 FANS 1/A- ATN B1
DM 2	Wait for a reply. <i>Note.</i> — <i>The controller is informed that the request is being assessed and there will be a <u>short-term</u> delay (within 10 minutes). The exchange is not closed and the request will be responded to when conditions allow.</i>	STANDBY	N	FANS 1/A ATN B1 FANS 1/A- ATN B1
DM 3	Message received and understood. <i>Note.</i> — <i>ROGER is the only correct response to an uplink free text message. Under no circumstances will ROGER be used instead of AFFIRM.</i>	ROGER	N	FANS 1/A ATN B1 FANS 1/A- ATN B1
DM 4	Yes. <i>Note.</i> — <i>AFFIRM is an appropriate response to an uplinked negotiation request message (e.g. <u>UM 150</u> CAN YOU ACCEPT [level] at [time]).</i>	AFFIRM	N	FANS 1/A ATN B1 FANS 1/A- ATN B1
DM 5	No. <i>Note.</i> — <i>NEGATIVE is an appropriate response to an uplinked negotiation request message (e.g. <u>UM 150</u> CAN YOU ACCEPT [level] at [time]).</i>	NEGATIVE	N	FANS 1/A ATN B1 FANS 1/A- ATN B1

Ref #	Message Intent/Use	Message Element	Resp.	Data link system(s)
	Vertical Requests (downlink)			
DM 6	Request to fly at the specified level.	REQUEST [level]	Y <u>UM 0</u> <u>UM 1</u> <u>UM 19</u> <u>UM 20</u> <u>UM 23</u> <u>UM 26</u> <u>UM 27</u> <u>UM 28</u> <u>UM 29</u> <u>UM 46</u> <u>UM 47</u> <u>UM 48</u> <u>UM 159</u> + <u>UM 183</u> <u>UM 162</u> <u>UM 211</u>	FANS 1/A ATN B1 FANS 1/A- ATN B1
DM 7	Request to fly at a level within the specified vertical range. <i>FANS 1/A-ATN B1.— FANS 1/A aircraft only. ATN B1 aircraft uses <u>DM 6</u> REQUEST [level], where [level] is a vertical range.</i>	REQUEST BLOCK [level] TO [level]	Y	FANS 1/A FANS 1/A -ATN B1
DM 8	Request to cruise climb to the specified level. <i>Note.— Avoid use of this message element due to potential misinterpretation.</i>	REQUEST CRUISE CLIMB TO [level]	Y	FANS 1/A

Ref #	Message Intent/Use	Message Element	Resp.	Data link system(s)
DM 9	Request to climb to the specified level.	REQUEST CLIMB TO [level]	Y <u>UM 0</u> <u>UM 1</u> <u>UM 19</u> <u>UM 20</u> <u>UM 23</u> <u>UM 26</u> <u>UM 27</u> <u>UM 28</u> <u>UM 29</u> <u>UM 46</u> <u>UM 47</u> <u>UM 48</u> <u>UM 159</u> + <u>UM 183</u> <u>UM 162</u> <u>UM 211</u>	FANS 1/A ATN B1 FANS 1/A- ATN B1
DM 10	Request to descend to the specified level.	REQUEST DESCENT TO [level]	Y <u>UM 0</u> <u>UM 1</u> <u>UM 19</u> <u>UM 20</u> <u>UM 23</u> <u>UM 26</u> <u>UM 27</u> <u>UM 28</u> <u>UM 29</u> <u>UM 46</u> <u>UM 47</u> <u>UM 48</u> <u>UM 159</u> + <u>UM 183</u> <u>UM 162</u> <u>UM 211</u>	FANS 1/A ATN B1 FANS 1/A- ATN B1
DM 11	Request that at the specified position a climb to the specified level be approved.	AT [position] REQUEST CLIMB TO [level]	Y	FANS 1/A
DM 12	Request that at the specified position a descent to the specified level be approved.	AT [position] REQUEST DESCENT TO [level]	Y	FANS 1/A

Ref #	Message Intent/Use	Message Element	Resp.	Data link system(s)
DM 13	Request that at the specified time a climb to the specified level be approved.	AT [time] REQUEST CLIMB TO [level]	Y	FANS 1/A
DM 14	Request that at the specified time a descent to the specified level be approved.	AT [time] REQUEST DESCENT TO [level]	Y	FANS 1/A
DM 69	Request that a descent be approved on a see-and-avoid basis. <i>Note.— Avoid use of this message element due to potential misinterpretation.</i>	REQUEST VMC DESCENT	Y	FANS 1/A
Lateral Off-Set Requests (downlink)				
DM 15	Request that a parallel track, offset from the cleared track by the specified distance in the specified direction, be approved.	REQUEST OFFSET [specified distance] [direction] OF ROUTE	Y	FANS 1/A
DM 16	Request that a parallel track, offset from the cleared track by the specified distance in the specified direction, be approved from the specified position.	AT [position] REQUEST OFFSET [specified distance] [direction] OF ROUTE	Y	FANS 1/A
DM 17	Request that a parallel track, offset from the cleared track by the specified distance in the specified direction, be approved from the specified time.	AT [time] REQUEST OFFSET [specified distance] [direction] OF ROUTE	Y	FANS 1/A
Speed Requests (downlink)				
DM 18	Request to fly at the specified speed.	REQUEST [speed]	Y <u>UM 0</u> <u>UM 1</u> <u>UM 162</u> <u>UM 211</u> <u>UM 55</u> <u>UM 61</u> <u>UM 106</u> <u>UM 107</u> <u>UM 108</u> <u>UM 109</u> <u>UM 116</u> <u>UM 222</u> <u>UM 159</u> + <u>UM 183</u>	FANS 1/A ATN B1 FANS 1/A- ATN B1

Ref #	Message Intent/Use	Message Element	Resp.	Data link system(s)
DM 19	Request to fly within the specified speed range.	REQUEST [speed] TO [speed]	Y	FANS 1/A
	Voice Contact Requests (downlink)			
DM 20	Request for voice contact.	REQUEST VOICE CONTACT	Y	FANS 1/A
DM 21	Request for voice contact on the specified frequency.	REQUEST VOICE CONTACT [frequency]	Y	FANS 1/A
	Route Modification Requests (downlink)			
DM 22	Request to track from the present position direct to the specified position.	REQUEST DIRECT TO [position]	Y <u>UM 0</u> <u>UM 162</u> <u>UM 211</u> <u>UM 74</u> <u>UM 96</u> <u>UM 190</u> <u>UM 159</u> + <u>UM 183</u>	FANS 1/A ATN B1 FANS 1/A- ATN B1
DM 23	Request for the specified procedure clearance.	REQUEST [procedure name]	Y	FANS 1/A
DM 24	Request for a route clearance.	REQUEST CLEARANCE [route clearance] or <i>REQUEST [route clearance]</i>	Y	FANS 1/A
DM 25	Request for a clearance. <i>Note.— Either pre-departure or route.</i>	REQUEST [clearance type] CLEARANCE or <i>REQUEST CLEARANCE</i>	Y	FANS 1/A
DM 26	Request for a weather deviation to the specified position via the specified route.	REQUEST WEATHER DEVIATION TO [position] VIA [route clearance]	Y	FANS 1/A

Ref #	Message Intent/Use	Message Element	Resp.	Data link system(s)
DM 27	Request for a weather deviation up to the specified distance off track in the specified direction.	REQUEST WEATHER DEVIATION UP TO [specified distance] [direction] OF ROUTE	Y <u>UM 0</u> <u>UM 162</u> <u>UM 211</u> <u>UM 64</u> <u>UM 74</u> <u>UM 82</u> <u>UM 96</u> <u>UM 190</u> <u>UM 159</u> + <u>UM 183</u>	FANS 1/A ATN B1 FANS 1/A- ATN B1
DM 70	Request a clearance to adopt the specified heading.	REQUEST HEADING [degrees]	Y	FANS 1/A
DM 71	Request a clearance to adopt the specified ground track.	REQUEST GROUND TRACK [degrees]	Y	FANS 1/A
	Reports (downlink)			
DM 28	Notification of leaving the specified level.	LEAVING [level]	N	FANS 1/A
DM 29	Notification of climbing to the specified level.	CLIMBING TO [level]	N	FANS 1/A
DM 30	Notification of descending to the specified level.	DESCENDING TO [level]	N	FANS 1/A
DM 31	Notification of passing the specified position.	PASSING [position]	N	FANS 1/A
DM 78	Notification that at the specified time, the aircraft's position was as specified.	AT [time] [distance] [to/from] [position]	N	FANS 1/A
DM 32	Notification of the present level.	PRESENT LEVEL [level] or <i>PRESENT ALTITUDE [altitude]</i>	N	FANS 1/A ATN B1 FANS 1/A- ATN B1
DM 33	Notification of the present position.	PRESENT POSITION [position]	N	FANS 1/A
DM 34	Notification of the present speed.	PRESENT SPEED [speed]	N	FANS 1/A

Ref #	Message Intent/Use	Message Element	Resp.	Data link system(s)
DM 113	Notification of the requested speed. <i>FANS 1/A.</i> — Uses <i>DM 67</i> free text for partial intent. The flight crew notifies the controller of present ground speed, in response to <i>UM 169b</i> , REPORT GROUND SPEED.	[speed type] [speed type] [speed type] SPEED [speed]	N	FANS 1/A
DM 35	Notification of the present heading in degrees.	PRESENT HEADING [degrees]	N	FANS 1/A
DM 36	Notification of the present ground track in degrees.	PRESENT GROUND TRACK [degrees]	N	FANS 1/A
DM 37	Notification that the aircraft is maintaining the specified level.	MAINTAINING [level] or <i>LEVEL [altitude]</i>	N	FANS 1/A
DM 72	(Reserved) <i>Note.</i> — Avoid use of this message element, <i>REACHING [level]</i> , as it is reserved in ICAO Doc 4444.	N/A	N	FANS 1/A
DM 76	Notification that the aircraft has reached a level within the specified vertical range.	REACHING BLOCK [level] TO [level]	N	FANS 1/A
DM 38	Read-back of the assigned level.	ASSIGNED LEVEL [level] or <i>ASSIGNED ALTITUDE [altitude]</i>	N	FANS 1/A ATN B1 FANS 1/A-ATN B1
DM 77	Read-back of the assigned vertical range. <i>FANS 1/A-ATN B1.</i> — <i>FANS 1/A aircraft only.</i> <i>ATN B1 aircraft uses DM 38 ASSIGNED LEVEL [level], where [level] is a vertical range.</i>	ASSIGNED BLOCK [level] TO [level]	N	FANS 1/A FANS 1/A-ATN B1
DM 39	Read-back of the assigned speed.	ASSIGNED SPEED [speed]	N	FANS 1/A
DM 40	Read-back of the assigned route.	ASSIGNED ROUTE [route clearance]	N	FANS 1/A
DM 41	The aircraft has regained the cleared route.	BACK ON ROUTE	N	FANS 1/A
DM 114	Notification that the aircraft is clear of weather and is able to accept a clearance to regain cleared flight route.	CLEAR OF WEATHER	N	N/A
DM 42	The next waypoint is the specified position.	NEXT WAYPOINT [position]	N	FANS 1/A

Ref #	Message Intent/Use	Message Element	Resp.	Data link system(s)
DM 43	The ETA at the next waypoint is as specified.	NEXT WAYPOINT ETA [time]	N	FANS 1/A
DM 44	The next plus one waypoint is the specified position.	ENSUING WAYPOINT [position]	N	FANS 1/A
DM 45	Clarification of previously reported waypoint passage.	REPORTED WAYPOINT [position]	N	FANS 1/A
DM 46	Clarification of time over previously reported waypoint.	REPORTED WAYPOINT [time]	N	FANS 1/A
DM 47	The specified (SSR) code has been selected.	SQUAWKING [code]	N	FANS 1/A
DM 48	Position report. <i>Note.— Reports the current position of the aircraft when the flight crew presses the button to send this message. ATC expects position reports based on this downlink message.</i>	POSITION REPORT [position report]	N	FANS 1/A
DM 79	The code of the latest ATIS received is as specified.	ATIS [atis code]	N	FANS 1/A
DM 89	The specified ATS unit is being monitored on the specified frequency. <i>FANS 1/A-ATN B1.— FANS 1/A aircraft uses <u>DM 67aa</u> free text. May require to be preformatted.</i>	MONITORING [unit name] [frequency]	N	FANS 1/A [free text] ATN B1 FANS 1/A-ATN B1
DM 102	Used to report that an aircraft has landed.	LANDING REPORT	N	N/A
DM 104	Notification of estimated time of arrival at the specified position. <i>FANS 1/A.— Uses free text <u>DM 67n</u>. Response to free text <u>UM 169d</u> REPORT ETA [position]</i>	ETA [position] [time] or [position] [time]	N	FANS 1/A [free text]
DM 105	Notification of the alternative aerodrome for landing.	ALTERNATE AERODROME [airport]	N	N/A
DM 106	Notification of the preferred level. <i>FANS 1/A.— Uses <u>DM 67m</u>. Response to free text <u>UM 169c</u> STATE PREFERRED LEVEL. FANS 1/A – ATN B1.— FANS 1/A aircraft response to <u>UM 231</u> STATE PREFERRED LEVEL.</i>	PREFERRED LEVEL [level] or FL[altitude]	N	FANS 1/A [free text] ATN B1 FANS 1/A-ATN B1

Ref #	Message Intent/Use	Message Element	Resp.	Data link system(s)
DM 109	Notification of the preferred time to commence descent for approach. <i>FANS 1/A.— Uses DM 67v. Response to free text UM 169aa STATE TOP OF DESCENT.</i> <i>FANS 1/A – ATN B1.— FANS 1/A aircraft response to UM 232 STATE TOP OF DESCENT.</i>	TOP OF DESCENT [time] or <i>TOD [time]</i>	N	FANS 1/A [free text] ATN B1 FANS 1/A-ATN B1
DM 110	Notification of the preferred position to commence descent for approach.	TOP OF DESCENT [position]	N	N/A
DM 111	Notification of the preferred time and position to commence descent for approach.	TOP OF DESCENT [time] [position]	N	N/A
	Negotiation Requests (downlink)			
DM 49	Request for the earliest time at which a clearance to the specified speed can be expected.	WHEN CAN WE EXPECT [speed]	Y	FANS 1/A
DM 50	Request for the earliest time at which a clearance to a speed within the specified range can be expected. <i>Note.— This message should not be used as it is not supported by the appropriate uplink message response: UM 103, UM 104 or UM 105.</i>	WHEN CAN WE EXPECT [speed] TO [speed]	Y	FANS 1/A
DM 51	Request for the earliest time at which a clearance to regain the planned route can be expected.	WHEN CAN WE EXPECT BACK ON ROUTE	Y	FANS 1/A
DM 52	Request for the earliest time at which a clearance to descend can be expected.	WHEN CAN WE EXPECT LOWER LEVEL or <i>WHEN CAN WE EXPECT LOWER ALTITUDE</i>	Y	FANS 1/A
DM 53	Request for the earliest time at which a clearance to climb can be expected.	WHEN CAN WE EXPECT HIGHER LEVEL or <i>WHEN CAN WE EXPECT HIGHER ALTITUDE</i>	Y	FANS 1/A

Ref #	Message Intent/Use	Message Element	Resp.	Data link system(s)
DM 54	Request for the earliest time at which a clearance to cruise climb to the specified level can be expected. <i>Note.</i> — <i>This message should not be used as it is not supported by the appropriate uplink message response: <u>UM 11</u>, <u>UM 12</u>, <u>UM 17</u>, or <u>UM 18</u>.</i>	WHEN CAN WE EXPECT CRUISE CLIMB TO [level]	Y	FANS 1/A
DM 87	Request for the earliest time at which a clearance to climb to the specified level can be expected. <i>FANS 1/A.</i> — <i>Uses preformatted free text <u>DM 67h</u>.</i>	WHEN CAN WE EXPECT CLIMB TO [level]	Y	FANS 1/A [free text]
DM 88	Request for the earliest time at which a clearance to descend to the specified level can be expected. <i>FANS 1/A.</i> — <i>Uses preformatted free text <u>DM 67i</u>.</i>	WHEN CAN WE EXPECT DESCENT TO [level]	Y	FANS 1/A [free text]
Emergency Messages (downlink)				
DM 55	<i>Urgency prefix.</i> <i>FANS 1/A – ATN B1.</i> — <i>Ground system will display message to controller for FANS 1/A aircraft.</i>	PAN PAN PAN	Y or N	FANS 1/A FANS 1/A- ATN B1 (Urgent)
DM 56	<i>Distress prefix.</i> <i>FANS 1/A – ATN B1.</i> — <i>Ground system will display message to controller for FANS 1/A aircraft.</i>	MAYDAY MAYDAY MAYDAY	Y or N	FANS 1/A FANS 1/A- ATN B1 (Distress)
DM 112	Indicates specifically that the aircraft is being subjected to unlawful interference.	SQUAWKING 7500	N	N/A (Urgent)
DM 57	<i>Notification of fuel remaining and number of persons on board.</i> <i>FANS 1/A – ATN B1.</i> — <i>Ground system will display message to controller for FANS 1/A aircraft.</i>	[remaining fuel] OF FUEL REMAINING AND [persons on board] PERSONS ON BOARD or <i>[remaining fuel] OF FUEL REMAINING AND [remaining souls] SOULS ON BOARD</i>	Y or N	FANS 1/A FANS 1/A- ATN B1 (Urgent)
DM 58	<i>Notification that the pilot wishes to cancel the emergency condition.</i> <i>FANS 1/A – ATN B1.</i> — <i>Ground system will display message to controller for FANS 1/A aircraft.</i>	CANCEL EMERGENCY	Y or N	FANS 1/A FANS 1/A- ATN B1 (Urgent)

Ref #	Message Intent/Use	Message Element	Resp.	Data link system(s)
DM 59	Notification that the aircraft is diverting to the specified position via the specified route due to an urgent need. <i>FANS 1/A – ATN B1.</i> — Ground system will display message to controller for FANS 1/A aircraft.	DIVERTING TO [position] VIA [route clearance]	Y or N	FANS 1/A FANS 1/A- ATN B1 (Urgent)
DM 60	Notification that the aircraft is deviating the specified distance in the specified direction off the cleared route and maintaining a parallel track due to an urgent need. <i>FANS 1/A – ATN B1.</i> — Ground system will display message to controller for FANS 1/A aircraft.	OFFSETTING [specified distance] [direction] OF ROUTE	Y or N	FANS 1/A FANS 1/A- ATN B1 (Urgent)
DM 61	Notification that the aircraft is descending to the specified level due to an urgent need. <i>FANS 1/A – ATN B1.</i> — Ground system will display message to controller for FANS 1/A aircraft.	DESCENDING TO [level]	Y or N	FANS 1/A FANS 1/A- ATN B1 (Urgent)
DM 80	Notification that the aircraft is deviating up to the deviating distance from the cleared route in the specified direction due to an urgent need. <i>FANS 1/A.</i> — Notification that the aircraft is operating on an offset. The urgency attribute for this message element is not defined.	DEVIATING UP TO [specified distance] [direction] OF ROUTE or <i>DEVIATING [distanceoffset] [direction] OF ROUTE</i>	Y or N	FANS 1/A (Urgent)
System Management Messages (downlink)				
DM 62	A system-generated message that the avionics has detected an error.	ERROR [error information]	N	FANS 1/A ATN B1 FANS 1/A- ATN B1 (Urgent)
DM 63	A system-generated denial to any CPDLC application message sent from a ground facility that is not the current data authority.	NOT CURRENT DATA AUTHORITY	N	FANS 1/A ATN B1 FANS 1/A- ATN B1

Ref #	Message Intent/Use	Message Element	Resp.	Data link system(s)
DM 99	A system-generated message to inform a ground facility that it is now the current data authority.	CURRENT DATA AUTHORITY	N	ATN B1 FANS 1/A-ATN B1 (Urgent)
DM 64	Notification to the ground system that the specified ATSU is the current data authority. <i>FANS 1/A – ATN B1.— FANS 1/A aircraft uses this message.</i>	[facility designation]	N	FANS 1/A FANS 1/A-ATN B1
DM 107	A system-generated message sent to a ground system that tries to connect to an aircraft when a current data authority has not designated the ground system as the NDA. <i>FANS 1/A – ATN B1.— ATN B1 aircraft uses this message.</i>	NOT AUTHORIZED NEXT DATA AUTHORITY	N	ATN B1
DM 73	A system-generated message indicating the software version number. <i>FANS 1/A – ATN B1.— FANS 1/A aircraft uses this message.</i>	[version number]	N	FANS 1/A FANS 1/A-ATN B1
DM 100	Confirmation to the ground system that the aircraft system has received the message to which the logical acknowledgement refers and found it acceptable for display to the responsible person. <i>FANS 1/A – ATN B1.— ATN B1 ground systems uses alternate means, such as MAS message assurance received from FANS 1/A aircraft, to mimic LOGICAL ACKNOWLEDGEMENT.</i>	LOGICAL ACKNOWLEDGEMENT	N	ATN B1
Additional Messages (downlink)				
DM 65	Used to explain reasons for pilot's message.	DUE TO WEATHER	N	FANS 1/A ATN B1 FANS 1/A-ATN B1
DM 66	Used to explain reasons for pilot's message.	DUE TO AIRCRAFT PERFORMANCE	N	FANS 1/A ATN B1 FANS 1/A-ATN B1

Ref #	Message Intent/Use	Message Element	Resp.	Data link system(s)
DM 74	States a desire by the pilot to provide his/her own separation and remain in VMC.	REQUEST TO MAINTAIN OWN SEPARATION AND VMC or <i>MAINTAIN OWN SEPARATION AND VMC</i>	Y or N	FANS 1/A
DM 75	Used in conjunction with another message to indicate that the pilot wishes to execute request when the pilot is prepared to do so.	AT PILOTS DISCRETION	N	FANS 1/A
DM 101	Allows the pilot to indicate a desire for termination of CPDLC application with the current data authority.	REQUEST END OF SERVICE	Y	N/A
DM 103	Allows the pilot to indicate that he/she has cancelled IFR flight plan.	CANCELLING IFR	Y	N/A
DM 108	Notification that de-icing action has been completed.	DE-ICING COMPLETE	N	N/A
Free Text – Normal (downlink)				
DM 67	Normal urgency, low alert <i>FANS 1/A – ATN B1.— FANS 1/A aircraft only. ATN B1 aircraft uses <u>DM 98</u>.</i>	[free text]	N	FANS 1/A FANS 1/A-ATN B1
Free Text - Distress (downlink)				
DM 68	Distress urgency, high alert <i>Note.— Selecting any of the emergency message elements will result in this message element being enabled for the flight crew to include in the emergency message at their discretion.</i>	[free text]	Y	FANS 1/A
DM 90	normal urgency, medium alert	[free text]	N	N/A
DM 91	normal urgency, low alert	[free text]	Y	N/A
DM 92	low urgency, low alert	[free text]	Y	N/A
DM 93	urgent urgency, high alert	[free text]	N	N/A (Urgent)
DM 94	distress urgency, high alert	[free text]	N	N/A (Distress)
DM 95	urgent urgency, medium alert	[free text]	N	N/A (Urgent)

Ref #	Message Intent/Use	Message Element	Resp.	Data link system(s)
DM 96	urgent urgency, low alert	[free text]	N	N/A (Urgent)
DM 97	low urgency, low alert	[free text]	N	N/A
DM 98	normal urgency, normal alert <i>FANS 1/A – ATN B1.— ATN B1 aircraft only. FANS 1/A aircraft uses DM 67.</i>	[free text]	N	ATN B1 FANS 1/A- ATN B1
Negotiation Responses (downlink)				
DM 81	We can accept the specified level at the specified time. <i>FANS 1/A.— Uses preformatted free text DM 67b.</i>	WE CAN ACCEPT [level] AT [time]	N	FANS 1/A [free text] ATN B1 FANS 1/A- ATN B1
DM 115	We can accept the specified level at the specified position.	WE CAN ACCEPT [level] AT [position]	N	N/A
DM 82	We cannot accept the specified level. <i>FANS 1/A.— Uses preformatted free text DM 67e.</i>	WE CANNOT ACCEPT [level]	N	FANS 1/A [free text] ATN B1 FANS 1/A- ATN B1
DM 83	We can accept the specified speed at the specified time. <i>FANS 1/A.— Uses preformatted free text DM 67c.</i>	WE CAN ACCEPT [speed] AT [time]	N	FANS 1/A [free text]
DM 116	We can accept the specified speed at the specified position.	WE CAN ACCEPT [speed] AT [position]	N	N/A
DM 84	We cannot accept the specified speed. <i>FANS 1/A.— Uses preformatted free text DM 67f.</i>	WE CANNOT ACCEPT [speed]	N	FANS 1/A [free text]
DM 85	We can accept a parallel track offset the specified distance in the specified direction at the specified time. <i>FANS 1/A.— Uses preformatted free text DM 67d.</i>	WE CAN ACCEPT [specified distance] [direction] AT [time]	N	FANS 1/A [free text]
DM 117	We can accept a parallel track offset the specified distance in the specified direction at the specified position.	WE CAN ACCEPT [specified distance] [direction] AT [position]	N	N/A

Ref #	Message Intent/Use	Message Element	Resp.	Data link system(s)
DM 86	We cannot accept a parallel track offset the specified distance in the specified direction. <i>FANS 1/A.— Uses preformatted free text DM 67g.</i>	WE CANNOT ACCEPT [specified distance] [direction]	N	FANS 1/A [free text]

A.5 CPDLC standardized free text messages

A.5.1 CPDLC standardized free text uplink messages

A.5.1.1 When a free text uplink message has been received, the flight crew should respond with ROGER before responding to the message.

Ref #	Message Intent/Use	Message Element	Resp.
	Standardized Free Text Responses/Acknowledgements (uplink)		
UM 169q	Acknowledgement of receipt of a CPDLC downlink MAYDAY message. <i>Note.— No equivalent to ICAO Doc 4444.</i>	ROGER MAYDAY	R
UM 169r	Acknowledgement of receipt of a CPDLC downlinked PAN message. <i>Note.— No equivalent to ICAO Doc 4444.</i>	ROGER PAN	R
UM 169ak	Notification that an ADS-C emergency report has been received from the aircraft. <i>Note.— No equivalent to ICAO Doc 4444.</i>	CONFIRM ADS-C EMERGENCY	R
UM 169s	Notification that the CPDLC downlink request was: 1) part of the approved message set; and 2) received by the controller. The aircraft will receive any further communication about the request via voice contact with the specified unit. [unit_description] is the name of the radio facility with which the response will be communicated. <i>Note.— No equivalent to ICAO Doc 4444.</i>	REQUEST RECEIVED RESPONSE WILL BE VIA [unit_description]	R
UM 169x	Indication that the request has been received and has been forwarded on to the next ATSU. <i>Note.— Same intent as ICAO Doc 4444 <u>UM 211.</u></i>	REQUEST FORWARDED	R

Ref #	Message Intent/Use	Message Element	Resp.
UM 169ab	Indicates that the request cannot be responded to by the current unit and that it should be requested from the next unit. <i>Note.</i> — Same intent as ICAO Doc 4444 UM 237 .	REQUEST AGAIN WITH NEXT UNIT	R
	Standardized Free Text Vertical Clearances (uplink)		
UM 169ac	Used with a vertical clearance, indicating an ITP clearance when there is one reference aircraft ahead. <i>Note.</i> — No equivalent to ICAO Doc 4444.	ITP BEHIND [aircraft identification]	R
UM 169ad	Used with a vertical clearance, indicating an ITP clearance when there is one reference aircraft behind. <i>Note.</i> — No equivalent to ICAO Doc 4444.	ITP AHEAD OF [aircraft identification]	R
UM 169ae	Used with a vertical clearance, indicating an ITP clearance when there are two reference aircraft, both ahead. <i>Note.</i> — No equivalent to ICAO Doc 4444.	ITP BEHIND [aircraft identification] AND BEHIND [aircraft identification]	R
UM 169af	Used with a vertical clearance, indicating an ITP clearance when there are two reference aircraft, both behind: <i>Note.</i> — No equivalent to ICAO Doc 4444.	ITP AHEAD OF [aircraft identification] AND AHEAD OF [aircraft identification]	R
UM 169al	Used with a vertical clearance, indicating an ITP clearance when there are two reference aircraft, one ahead and the other behind. <i>Note.</i> — No equivalent to ICAO Doc 4444.	ITP BEHIND [aircraft identification] AND AHEAD OF [aircraft identification]	R
	Standardized Free Text Speed Changes (uplink)		
UM 169p	Notification that a previously issued speed can be expected to be maintained until the specified position or time. <i>Note.</i> — No equivalent to ICAO Doc 4444.	EXPECT TO MAINTAIN [speed] UNTIL [time / position]	R
UM 169z	Notification that the aircraft may keep its preferred speed without restriction. <i>Note.</i> — Same intent as ICAO Doc 4444 UM 222 .	NO SPEED RESTRICTION	R

Ref #	Message Intent/Use	Message Element	Resp.
	Standardized Free Text Contact/Monitor/Surveillance Requests (uplink)		
UM 169ai	Instruction that the “ident” function of the ADS-B emitter is to be activated. <i>Note.</i> — Same intent as ICAO Doc 4444 UM 242 .	TRANSMIT ADS-B IDENT	R
	Standardized Free Text Report/Confirmation Requests (uplink)		
UM 169b	Instruction to report the ground speed of the aircraft. <i>Note.</i> — Intent similar partially to ICAO Doc 4444 UM 134 .	REPORT GROUND SPEED	R, then DM 67l
UM 169c	Instruction to advise the preferred flight level for the flight. <i>Note.</i> — Same intent as ICAO Doc 4444 UM 231	STATE PREFERRED LEVEL	R, then DM 67m
UM 169d	Instruction to report the estimated time of arrival at the specified position. <i>Note.</i> — Same intent as ICAO Doc 4444 UM 228 .	REPORT ETA [position]	R, then DM 67n
UM 169e	Instruction to notify when the specified traffic has been observed by visual contact to have passed. <i>Note.</i> — No equivalent to ICAO Doc 4444.	REPORT SIGHTING AND PASSING OPPOSITE DIRECTION [traffic description] ETP [time]	R, then DM 67o DM 67p
UM 169f	Instruction to notify of receipt of any ADS-C report indicating a deviation from cleared route and to request the flight crew to advise of intentions. <i>Note.</i> — No equivalent to ICAO Doc 4444.	ADS-C INDICATES OFF ROUTE. ADVISE INTENTIONS.	R, and then DM 67
UM 169t	Instruction to notify of receipt of any ADS-C report indicating a deviation from cleared level and to request the flight crew to advise of intentions. <i>Note.</i> — No equivalent to ICAO Doc 4444.	ADS-C INDICATES LEVEL DEVIATION. ADVISE INTENTIONS.	R, and then DM 67
UM 169v	Instruction to notify of receipt of any ADS-C report indicating a deviation from cleared speed and to request the flight crew to advise of intentions. <i>Note.</i> — No equivalent to ICAO Doc 4444.	ADS-C INDICATES SPEED DEVIATION. ADVISE INTENTIONS.	R, and then DM 67

Ref #	Message Intent/Use	Message Element	Resp.
UM 169h	Instruction to notify of receipt of any ADS-C report that appears to contain inaccurate time estimates and to request the flight crew to check FMS. <i>Note.— No equivalent to ICAO Doc 4444.</i>	ADS-C ESTIMATES APPEAR INACCURATE. CHECK FMS.	R
UM 169aa	Instruction to indicate the preferred time to commence descent to the aerodrome of intended arrival. <i>Note.— Same intent as ICAO Doc 4444 <u>UM 232</u> for time only.</i>	STATE TOP OF DESCENT	R, then <u>DM 67v</u>
	Standardized Free text Air Traffic Advisories (uplink)		
UM 169k	Notification that a SELCAL check on the specified HF frequency should be expected. <i>Note.— No equivalent to ICAO Doc 4444.</i>	EXPECT SELCAL CHECK HF [frequency]	R
UM 169l	Notification that the CPDLC transfer process will not be completed at the boundary and will be delayed until the specified time or position. If the CPDLC transfer is not completed by the specified time or position, the flight crew should manually disconnect CPDLC and initiate a logon to the next center. <i>Note.— No equivalent to ICAO Doc 4444.</i>	EXPECT CPDLC TRANSFER AT [time/position]	R
UM 169aj	ATS advisory that the radar and/or ADS-B service is terminated. <i>Note.— Same intent as ICAO Doc 4444 <u>UM 244</u>.</i>	IDENTIFICATION TERMINATED	R
UM 169m	Notification that a CPDLC connection is not required by the next ATSU (e.g. due to short transition time through the next ATSU's airspace) and CPDLC connection will be transferred to the subsequent ATSU. <i>Note.— No equivalent to ICAO Doc 4444.</i>	EXPECT NEXT CENTER [facility designation]. CONTACT WITH [facility designation] NOT REQUIRED	R
UM 169n	Notification of traffic significant to the flight. <i>Note.— No equivalent to ICAO Doc 4444.</i>	TRAFFIC IS [traffic description]	R, then, (optionally) <u>DM 67q</u>
UM 169o	Notification of the secondary frequency for the area. <i>Note.— Same intent as ICAO Doc 4444 <u>UM 238</u>.</i>	SECONDARY FREQUENCY [frequency]	R

Ref #	Message Intent/Use	Message Element	Resp.
UM 169ag	ATS advisory that normal voice communication is not available. <i>Note.</i> — No equivalent to ICAO Doc 4444.	TRY SATCOM VOICE OR RELAY THROUGH ANOTHER AIRCRAFT	R
UM 169y	ATS advisory that the specified altimeter setting relates to the specified facility. <i>Note.</i> — Same intent as ICAO Doc 4444 <u>UM 213</u> .	[facility designation] ALTIMETER [altimeter]	R
UM 169av	Used after ATC cannot comply with an ITP request to advise of intermediate flight levels that are available for an ITP. <i>Note.</i> — No equivalent to ICAO Doc 4444.	SEND NEW ITP REQUEST IF ABLE [level]	R
	Standardized Free Text System Management Messages (uplink)		
UM 169j	Instruction to check the status of CPDLC messages and to respond to unanswered uplink messages. <i>Note.</i> — No equivalent to ICAO Doc 4444.	CHECK AND RESPOND TO OPEN CPDLC MESSAGES	R
UM 169w	Instruction to set the message latency monitor to the specified value. <i>Note.</i> — No equivalent to ICAO Doc 4444.	SET MAX UPLINK DELAY VALUE TO [delayed message parameter] SECONDS	R
UM 169au	Instruction to check that the message latency monitor function is off. <i>Note 1.</i> — No equivalent in ICAO Doc 4444.	CONFIRM MAX UPLINK DELAY VALUE IS NOT SET	R
UM 169u	Notification that an element contained in a CPDLC downlink message was not part of the approved CPDLC message set. <i>Note.</i> — Equivalent to ICAO Doc 4444 <u>UM 162</u> .	MESSAGE NOT SUPPORTED BY THIS ATS UNIT	R
UM 169ah	Notification that an element contained in a CPDLC downlink message was not part of the approved message set. The message should be communicated by voice (i.e. radiotelephone (RTF)). <i>Note.</i> — No equivalent to ICAO Doc 4444.	MESSAGE NOT SUPPORTED BY THIS ATS UNIT, CONTACT RTF	R
UM 169am or UM 183am	Instruction to turn the CPDLC application off and to initiate a logon to the specified ATSU.	AUTOMATIC TRANSFER OF CPDLC FAILED. WHEN ENTERING [unit name] AREA DISCONNECT CPDLC THEN LOGON TO [facility designation]	R

Ref #	Message Intent/Use	Message Element	Resp.
UM 169an	Instruction for the flight crew to check that the ADS-C function is armed.	CONFIRM ADS-C ARMED	R
UM 169ao	Instruction to transmit CPDLC position reports due to the failure of ADS-C.	ADS-C SHUT DOWN AT [facility designation]. REVERT TO CPDLC POSITION REPORTS. LEAVE ADS-C ARMED.	R
UM 169at	Instruction to transmit voice position reports due to the failure of ADS-C.	ADS-C SHUT DOWN AT [facility designation]. REVERT TO VOICE POSITION REPORTS. LEAVE ADS-C ARMED.	R
UM 169aw	Instruction to advise that CPDLC and voice position reports are not required due to ADS-C resuming operations.	RESUME NORMAL ADS-C OPERATIONS. CPDLC AND VOICE POSITION REPORTS NOT REQUIRED	R
UM 169ax	Instruction to continue on voice due to the failure of CPDLC.	CPDLC WILL BE SHUT DOWN. DISCONNECT CPDLC. CONTINUE ON VOICE	R
UM 169ap	Instruction for intermediary CPDLC-capable aircraft to relay message to aircraft not in communication with ATC.	RELAY TO [call sign] [unit name] [text of message to be relayed]	R, then <u>DM 67ae</u>
	Standardized Free Text Military (uplink)		
UM 169aq	Notification that MARSAs procedures with the specified aircraft have been terminated.	MARSAs TERMINATED WITH [call sign(s) of receiver aircraft]	R
UM 169ar		CLEARED TO DELAY FOR AIR REFUEL AT [position] UNTIL [time]	R
UM 169as		CLEARED TO CONDUCT REFUELING	R

A.5.2 CPDLC standardized free text downlink messages

Ref #	Message Intent/Use	Message Element	Resp.
	Standardized Free Text Route Modification Requests (downlink)		
DM 67ad	Request for a tailored arrival. The TA designator and speed are optional. <i>Note 1.— No equivalent in ICAO Doc 4444.</i> <i>Note 2.— When pre-formatting of the downlink message is not available, the flight crew can shorten to:</i> <i>REQ TA [TA designator]</i>	REQUEST TAILORED ARRIVAL [TA designator] [speed] or <i>REQ TA [TA designator] [speed]</i>	N
DM 67a	Used with a vertical request, indicating an ITP request when there is one reference aircraft ahead. <i>Note 1.— No equivalent in ICAO Doc 4444.</i>	ITP [distance] BEHIND [aircraft identification]	N
DM 67r	Used with a vertical request, indicating an ITP request when there is one reference aircraft behind. <i>Note 1.— No equivalent in ICAO Doc 4444.</i>	ITP [distance] AHEAD OF [aircraft identification]	N
DM 67s	Used with a vertical request, indicating an ITP request when there are two reference aircraft, both ahead. <i>Note 1.— No equivalent in ICAO Doc 4444.</i>	ITP [distance] BEHIND [aircraft identification] AND [distance] BEHIND [aircraft identification]	N
DM 67t	Used with a vertical request, indicating an ITP request when there are two reference aircraft, both behind. <i>Note 1.— No equivalent in ICAO Doc 4444.</i>	ITP [distance] AHEAD OF [aircraft identification] AND [distance] AHEAD OF [aircraft identification]	N
DM 67ag	Used with a vertical request, indicating an ITP request when there are two reference aircraft, one ahead and the other behind. <i>Note 1.— No equivalent in ICAO Doc 4444.</i>	ITP [distance] BEHIND [aircraft identification] AND [distance] AHEAD OF [aircraft identification]	N
	Standardized Free Text Reports (downlink)		
DM 67k	Notification of a revised estimate for the specified position. <i>Note.— Intent similar to DM 43.</i>	REVISED ETA [position] [time]	N
DM 67l	Notification of the ground speed. <i>Note 1.— Intent partial to ICAO Doc 4444 DM 113.</i> <i>Note 2.— When pre-formatting of the downlink message is not available, the flight crew can shorten to:</i> <i>GS [speed]</i>	GROUND SPEED [speed] or <i>GS [speed]</i>	N

Ref #	Message Intent/Use	Message Element	Resp.
DM 67m	Notification of the preferred level. <i>Note 1.— Same intent as ICAO Doc 4444 DM 106.</i> <i>Note 2.— When pre-formatting of the downlink message is not available, the flight crew can shorten to: FL[altitude]</i>	PREFERRED LEVEL [level] or <i>FL [altitude]</i>	N
DM 67n	Notification of estimated time of arrival at the specified position. <i>Note 1.— Same intent as ICAO Doc 4444 DM 104.</i> <i>Note 2.— When pre-formatting of the downlink message is not available, the flight crew can shorten to: [position] [time]</i>	ETA [position] [time] or <i>[position] [time]</i>	N
DM 67o	Notification that the flight crew has visually sighted and passed the specified traffic. <i>Note.— No equivalent in ICAO Doc 4444.</i>	[traffic identification] SIGHTED AND PASSED	N
DM 67p	Notification that the flight crew did NOT visually sight the specified traffic. <i>Note.— No equivalent in ICAO Doc 4444.</i>	[traffic identification] NOT SIGHTED	N
DM 67q	Notification that the previously described traffic has been sighted. <i>Note.— No equivalent in ICAO Doc 4444.</i>	TRAFFIC SIGHTED	N
DM 67v	Notification of the preferred time to commence descent for an approach. <i>Note 1.— Same intent as ICAO Doc 4444 DM 109.</i> <i>Note 2.— When pre-formatting of the downlink message is not available, the flight crew can shorten to: TOD [time]</i>	TOP OF DESCENT [time] or <i>TOD [time]</i>	N

Ref #	Message Intent/Use	Message Element	Resp.
DM 67aa	The specified ATSU is being monitored on the specified frequency. <i>Urgent urgency attribute.</i> <i>Note 1.— Airborne automation (i.e. preformatted message rather than the flight crew typing the text) may be necessary for message composition and to ensure accuracy of the message content. Consequently, not all aircraft will be equipped with such automation.</i> <i>Note 2.— Same intent as ICAO Doc 4444 DM 89.</i>	MONITORING [unit name] [frequency]	N
	Standardized Free Text System Management Messages (downlink)		
DM 67u or DM 98u	Notification that the delivery time of an uplink message exceeded the maximum permitted by the latency timer. The uplink message should be re-sent or communicated by other means. <i>Note.— No equivalent in ICAO Doc 4444.</i>	UPLINK DELAYED IN NETWORK AND REJECTED - RESEND OR CONTACT BY VOICE	N
DM 67j	Notification that the transfer of the CPDLC connection has failed. <i>Note.— No equivalent in ICAO Doc 4444.</i>	CPDLC TRANSFER FAILURE	N
DM 67ab	Notification that the ADS-C emergency mode was inadvertent and has been set to OFF. <i>Note.— No equivalent in ICAO Doc 4444.</i>	ADS-C RESET	N
DM 67ae	Notification from the intermediary CPDLC-capable aircraft that the aircraft not in communication received the instructions.	RELAY FROM [call sign] [response parameters]	N
DM 67af	Notification that the aircraft does not have the functionality of a message latency monitor. <i>Note 1.— No equivalent in ICAO Doc 4444.</i> <i>Note 2.— Response to free text UM 169au CONFIRM MAX UPLINK DELAY VALUE IS NOT SET or UM 169w SET MAX UPLINK DELAY VALUE TO [delayed message parameter] SECONDS.</i>	TIMER NOT AVAILABLE	N
	Standardized Free Text Additional messages (downlink)		
DM 67ac	Used with DM 27 , indicating a request for a weather deviation on both sides of route.	AND [specified distance] [direction]	N

Ref #	Message Intent/Use	Message Element	Resp.
	Standardized Free Text Negotiation Responses (downlink)		
DM 67b	We can accept the specified level at the specified time. <i>Note.— Intent equivalent to ICAO Doc 4444 DM 81.</i>	WE CAN ACCEPT [altitude] AT [time]	N
DM 67c	We can accept the specified speed at the specified time. <i>Note.— Intent equivalent to ICAO Doc 4444 DM 83.</i>	WE CAN ACCEPT [speed] AT [time]	N
DM 67d	We can accept a parallel track offset the specified distance in the specified direction at the specified time. <i>Note.— Intent equivalent to ICAO Doc 4444 DM 85.</i>	WE CAN ACCEPT [specified distance] [direction] AT [time]	N
DM 67e	We cannot accept the specified level. <i>Note.— Intent equivalent to ICAO Doc 4444 DM 82.</i>	WE CANNOT ACCEPT [altitude]	N
DM 67f	We cannot accept the specified speed. <i>Note.— Intent equivalent to ICAO Doc 4444 DM 84.</i>	WE CANNOT ACCEPT [speed]	N
DM 67g	We cannot accept a parallel track offset the specified distance in the specified direction. <i>Note.— Intent equivalent to ICAO Doc 4444 DM 86.</i>	WE CANNOT ACCEPT [specified distance] [direction]	N
DM 67h	Request for the earliest time at which a clearance to climb to the specified level can be expected. <i>Note.— Intent equivalent to ICAO Doc 4444 DM 87.</i>	WHEN CAN WE EXPECT CLIMB TO [altitude]	N
DM 67i	Request for the earliest time at which a clearance to descend to the specified level can be expected. <i>Note.— Intent equivalent to ICAO Doc 4444 DM 88.</i>	WHEN CAN WE EXPECT DESCENT TO [altitude]	N

Ref #	Message Intent/Use	Message Element	Resp.
	Standardized Free Text Military (downlink)		
DM 67w	Request for a delay at the specified position until a specified time to rendezvous with the receiver aircraft. <i>Note 1.— [position] is the ARCP as filed in the tanker's flight plan. [time] is the time the tanker expects to pass the ARCP and commence refueling along the refueling route. It is also the end of the delay time.</i> <i>Note 2.— No equivalent in ICAO Doc 4444.</i>	TO DELAY FOR AIR REFUEL AT [position] UNTIL [time]	N
DM 67x	Notification that refueling will end at the specified time or position. <i>Note.— No equivalent in ICAO Doc 4444.</i>	EXPECT END OF REFUEL AT [time/position]	N
DM 67y	Notification that the aircraft will be joining the specified ALTRV at the specified position or time. <i>Note.— No equivalent in ICAO Doc 4444.</i>	JOINING ALTRV [ALTRV designator] AT [time/position]	N
DM 67z	Notification that the tanker will accept MARSAs with the specified (receiver) aircraft. <i>Note.— No equivalent in ICAO Doc 4444.</i>	ACCEPT MARSAs WITH [call sign(s) of receiver aircraft]	N

Appendix B RCP specifications

B.1 General

B.1.1 This appendix includes specifications for RCP 240 and RCP 400. These specifications support:

- a) Safety oversight of air traffic service provisions and operations;
- b) Agreements/contractual arrangements that ANSPs and aircraft operators make with their respective CSPs;
- c) Operational authorizations, flight crew training and qualification;
- d) Design approval of aircraft data link systems; and
- e) Operational-monitoring, analysis, and exchange of operational data among regions and states.

B.1.2 The RCP specifications are derived mainly from a safety assessment. However, in cases where it has been determined to be beneficial, the RCP specification may include criteria to support operational efficiency and orderly flow of air traffic. In these cases, the RCP specification indicates the distinction between safety and efficiency.

B.1.3 The RCP specifications provide a means of compliance, in general. Additional guidance related to service provision, aircraft approval and operational authorizations can be found in [Chapter 3](#). Guidance and requirements on post-implementation monitoring can be found at [Appendix D](#).

B.1.4 The RCP specifications include allocations for data communications. The /D designator is used to indicate the RCP allocations associated with the CPDLC application.

B.2 Terms and acronyms

Note.— The terms applied to the RCP specifications are taken from ICAO Doc 9869, First Edition, Manual on Required Communication Performance, dated 2008. Additional terms are provided, as appropriate, to clarify meaning and measurement points for the RCP allocations.

RCP specification	
Term	Description
Operational communication transaction	The process a human uses to initiate the transmission of an instruction, clearance, flight information, and/or request, and is completed when that human is confident that the transaction is complete.
RCP specification	A set of ATS provision, including communication services, operator and flight crew requirements (e.g. RCP 240) needed for communications supporting a performance-based operation within a defined airspace.

RCP specification	
Term	Description
RCP type	A label (e.g. RCP 240) that represents the values assigned to RCP parameters for communication transaction time, continuity, availability and integrity. (ICAO) <i>Note.</i> — <i>This document uses the term RCP specification to align RCP with RNP and RNAV specifications provided in the Performance Based Navigation Manual.</i>
RCP expiration time (ET)	The maximum time for the completion of the operational communication transaction after which the initiator is required to revert to an alternative procedure.
RCP nominal time (TT 95%)	The maximum nominal time within which 95% of operational communication transactions is required to be completed.
RCP continuity (C)	The required probability that an operational communication transaction can be completed within the communication transaction time, either ET or TT 95%, given that the service was available at the start of the transaction.
RCP availability (A)	The required probability that an operational communication transaction can be initiated when needed.
RCP integrity (I)	The required probability that an operational communication transaction is completed with no undetected errors. <i>Note.</i> — <i>Whilst RCP integrity is defined in terms of the “goodness” of the communication capability, it is specified in terms of the likelihood of occurrence of malfunction on a per flight hour basis (e.g. 10^{-5}), consistent with RNAV/RNP specifications.</i>

RCP transaction time	
Term	Description
Monitored operational performance (TRN)	The portion of the transaction time (used for intervention) that does not include the times for message composition or recognition of the operational response.
Required communication technical performance (RCTP)	The portion of the (intervention) transaction time that does not include the human times for message composition, operational response, and recognition of the operational response.
Responder performance criteria	The operational portion of the transaction time to prepare the operational response, and includes the recognition of the instruction, and message composition (e.g. flight crew/HMI) for intervention transactions.
$RCTP_{ATSU}$	The summed critical transit times for an ATC intervention message and a response message, allocated to the ATSU system.
$RCTP_{CSP}$	The summed critical transit times for an ATC intervention message and a response message, allocated to the CSP system.

RCP transaction time	
Term	Description
RCTP _{AIR}	The summed critical transit times for an ATC intervention message and a response message, allocated to the aircraft system.

RCP Continuity	
Term	Description
C for TRN	The proportion of intervention messages and responses that can be delivered within the specified TRN for intervention.
C for RCTP	The proportion of intervention messages and responses that can be delivered within the specified RCTP for intervention.
C for RCTP _{ATSU}	The proportion of intervention messages and responses that can be delivered within the specified RCTP _{ATSU} for Intervention.
C for RCTP _{CSP}	The proportion of intervention messages and responses that can be delivered within the specified RCTP _{CSP} for Intervention.
C for RCTP _{AIR}	The proportion of intervention messages and responses that can be delivered within the specified RCTP _{AIR} for Intervention.

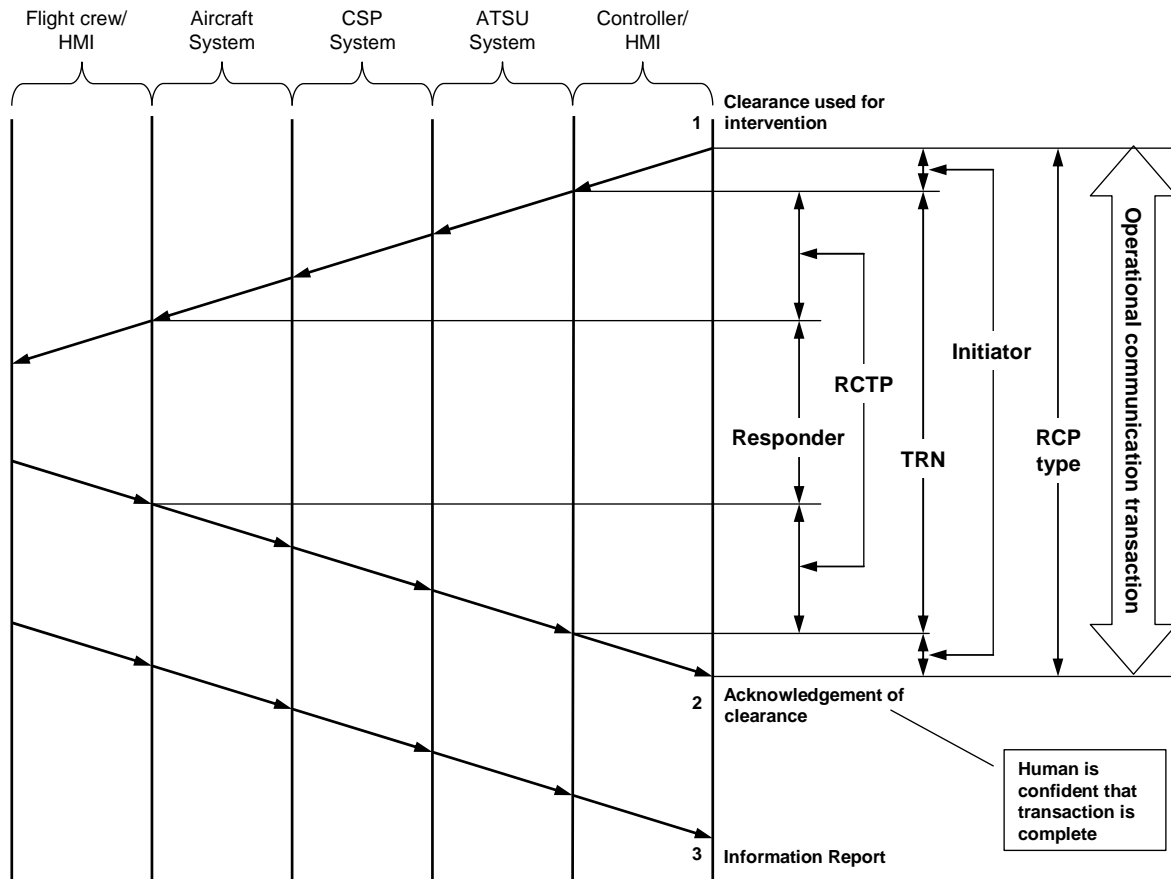

RCP Availability		
Term	Description	
Service availability (A_{CSP})	The required probability that the communication service is available to all users in a specific airspace when desired.	
Unplanned outage duration limit (minutes)	Time after the unplanned outage begins at which there is an operational impact. Measured from when an unplanned outage begins to when the ATSU receives notification that the service has been restored.	
Maximum number of unplanned outages	Measured separately for each relevant operational airspace over any 12-month period.	
Maximum accumulated unplanned outage time (min/yr)	Measured by accumulating <i>only</i> the duration times for unplanned outages greater than the unplanned outage duration limit during any 12-month period. The accumulation is performed separately for each relevant operational airspace.	
Unplanned outage notification delay (min)	Notification to the ATSU of an unplanned outage. Measured from when the unplanned outage begins to when the ATSU receives notification.	

RCP Availability	
Term	Description
Aircraft system availability (A_{AIR})	The required probability of available capability on an aircraft with an average flight of 6 hours. <i>Note.— The actual aircraft system availability is computed assuming that the service is available in the relevant airspace.</i>

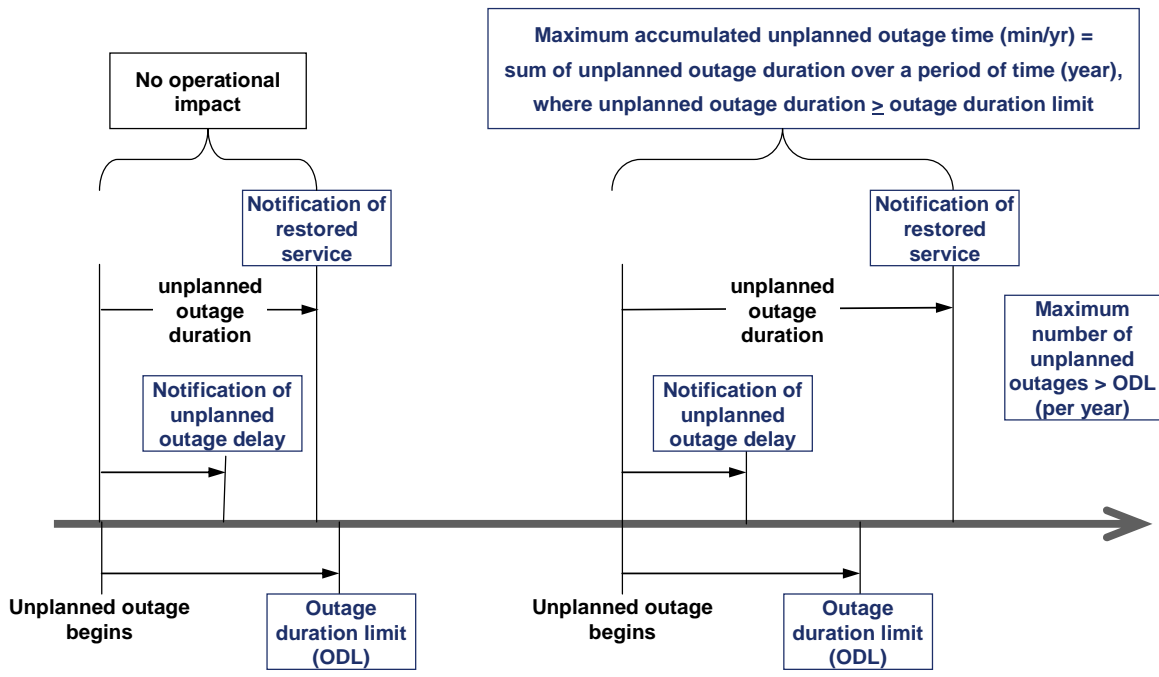

B.3 RCP 240 specification

RCP Specification			
RCP specification		RCP 240	
Airspace specific considerations			
Interoperability	Specify interoperability criteria (e.g. FANS 1/A)		
ATS Function	Specify ATS function(s) (e.g. applicable separation standard)		
Application	Specify controller-pilot ATC communication intervention capability (e.g. CPDLC application per ICAO Doc 4444, and RTCA DO-306/EUROCAE ED-122, Annex A)		
RCP parameter values			
Transaction time (sec)	Continuity (C)	Availability (A)	Integrity (I)
ET = 240	C(ET) = 0.999	0.999	Malfunction = 10^{-5} per flight hour
TT 95% = 210	C(TT 95%) = 0.95	0.9999 (efficiency)	
RCP monitoring and alerting criteria			
Ref	Criteria		
MA-1	The system shall be capable of detecting failures and configuration changes that would cause the communication service to no longer meet the RCP specification for the intended function.		
MA-2	When the communication service can no longer meet the RCP specification for the intended function, the flight crew and/or the controller shall take appropriate action.		
Notes			
<i>Note 1.— Rationale for the criteria provided in this specification can be found in ICAO Annex 11, ICAO Doc 4444, ICAO Doc 9689, and RTCA DO-306/ED-122.</i>			
<i>Note 2.— The values for transaction times are to be applied to transactions that are representative of communication capability for the controller to intervene with a specific operator, aircraft type, and aircraft identification.</i>			
<i>Note 3.— If changes are made to the system capacity limits, as specified by the airspace requirements, and the changes cause the system to perform below the RCP specification, this would be considered a change in system configuration.</i>			
<i>Note 4.— DO-306/ED-122 specifies an availability value based on safety assessment of the operational effects of the loss of the service. The availability value herein is more stringent, based on an additional need to maintain orderly and efficient operations.</i>			

B.3.1 RCP 240/D allocations

B.3.1.1 General

B.3.1.1.1 The RCP 240/D allocations are applicable to the CPDLC application.

B.3.1.2 Air navigation service provider (ANSP)

RCP communication transaction time and continuity criteria			
Specification: RCP 240/D	Application: CPDLC		Component: ANSP
Transaction Time Parameter	ET (sec) C = 99.9%	TT (sec) C = 95%	Compliance Means
Transaction Time Value	240	210	Analysis, CSP contract/service agreement. See also paragraph B.3.1.3 .
RCP Time Allocations			
Initiator	30	30	Analysis, simulations, safety and human factors assessments
TRN	210	180	Monitored, CSP contract/service agreement. See also paragraph B.3.1.3 .
TRN Time Allocations			
Responder	60	60	Initially, by analysis, simulations, safety human factors assessments Post-implementation, monitored, estimated
RCTP	150	120	Monitored, estimated, CSP contract/service agreement. See also paragraph B.3.1.3 .
RCTP Time Allocation			
RCTP_{ATSU}	15	10	Pre-implementation demonstration

RCP availability criteria			
Specification: RCP 240/D	Application: CPDLC		Component: ANSP
Availability parameter	Efficiency	Safety	Compliance means
Service availability (A_{CSP})	0.9999	0.999	Contract/service agreement terms. <i>Note.</i> — For guidelines to aid in the development of the contract/service agreement with the CSP, see paragraph B.3.1.3 , RCP 240/D allocation to CSP for RCP availability criteria.

RCP integrity criteria		
Specification: RCP 240/D	Application: CPDLC	Component: ANSP
Integrity parameter	Integrity value	Compliance means
Integrity (I)	Malfunction = 10^{-5} per flight hour	Analysis, safety requirements, development assurance level commensurate with integrity level, (compliance shown prior to operational implementation). See also RCP related safety requirement SR-26 for the ANSP. CSP contract/service agreement. See also RCP integrity criteria for CSP, paragraph B.3.1.3 .

RCP monitoring and alerting criteria		
Specification: RCP 240/D	Application: CPDLC	Component: ANSP
Ref:	Criteria	Compliance means
MA-1a	The ground system shall be capable of detecting ground system failures and configuration changes that would cause the communication service to no longer meet the requirements for the intended function. <i>Note.— If changes are made to the system capacity limits, as specified by the airspace requirements, and the changes cause the system to perform below the RCP specification, this would be considered a change in system configuration.</i>	System design, implementation. CSP contract/service agreement. See also paragraph B.3.1.3 , RCP availability criteria.
MA-1b	When the communication service no longer meets the requirements for the intended function, the ground system shall provide indication to the controller.	System design, implementation. CSP contract/service agreement. See also paragraph B.3.1.3 , RCP availability criteria.
MA-2	When the controller receives an indication that the communication service no longer meets the requirements for the intended function (e.g. reduced longitudinal separation), the controller shall take action to resolve the situation, (e.g. apply an alternative form of separation).	System design, procedures, implementation

RCP related safety requirements		
Specification: RCP 240/D	Application: CPDLC	Component: ANSP
Ref	Related RCP Parameter	Safety requirement
SR-1a (ANSP)	A	The ATSU shall display the indication provided by the aircraft system when a data link service request initiated by the ground system or the controller is rejected at the application layer.

RCP related safety requirements		
Specification: RCP 240/D		Application: CPDLC
		Component: ANSP
Ref	Related RCP Parameter	Safety requirement
SR-1b (ANSP)	A	The ATSU shall provide to the aircraft system an indication when it rejects a data link service request initiated by the flight crew at the application layer.
SR-2 (ANSP)	A, C	The ATSU shall indicate to the controller a detected loss of data link service.
SR-3 (ANSP)	A	Data link service shall be established in sufficient time to be available for operational use.
SR-4 (ANSP)	A, C	ATSU shall be notified of planned outage of data link service sufficiently ahead of time.
SR-5 (ANSP)	A, C	The ATSU shall indicate to the controller when a message cannot be successfully transmitted.
SR-6 (ANSP)	C, I	The ATSU end system shall provide unambiguous and unique identification of the origin and destination with each message it transmits.
SR-7 (ANSP)	C, I	The ATSU shall indicate in each response to which messages it refers.
SR-8 (ANSP)	I	The ATSU shall send the route clearance information with the route clearance via data link.
SR-9 (ANSP)	C, I	The ATSU end system shall time stamp to within one second UTC each message when it is released for onward transmission.
SR-11 (ANSP)	C, I	Any processing performed by ATSU (data entry/ encoding/ transmitting/ decoding/ displaying) shall not affect the intent of the message.
SR-12 (ANSP)	C, I	The ATSU end system shall reject messages not addressed to itself.
SR-13 (ANSP)	C, I	The ATSU shall transmit messages to the designated aircraft system.
SR-14 (ANSP)	A, C, I	The ATSU system shall indicate to the controller when a required response for a message sent by the ATSU is not received within the required time (ET_{TRN}).
SR-15 (ANSP)	C, I	When the ATSU receives a message whose time stamp exceeds ET_{TRN} , the ATSU shall provide appropriate indication.
SR-16 (ANSP)	C, I	The ATSU shall prevent the release of clearance without controller action.
SR-17 (ANSP)	C, I	The ATSU shall prohibit operational processing by controller of corrupted messages.

RCP related safety requirements		
Specification: RCP 240/D		Application: CPDLC
		Component: ANSP
Ref	Related RCP Parameter	Safety requirement
SR-18 (ANSP)	C, I	The ATSU shall be able to determine the message initiator.
SR-19 (ANSP)	C, I	The ATSU shall prohibit to the controller operational processing of messages not addressed to the ATSU.
SR-20 (ANSP)	C, I	ATSU shall only establish and maintain data link services when the aircraft identifiers in data link initiation correlates with the ATSU's corresponding aircraft identifiers in the current flight plan.
SR-21 (ANSP)	C, I	The aircraft identifiers used for data link initiation correlation by the ATSU shall be unique and unambiguous (e.g. the Aircraft Identification and either the Registration Marking or the Aircraft Address).
SR-23 (ANSP)	C, I	An ATSU system shall not permit data link services when there are non-compatible version numbers.
SR-24 (ANSP)	C, I	The ATSU shall respond to messages in their entirety.
SR-25 (ANSP)	I	The ATSU end system shall be capable of detecting errors that would result in misdelivery introduced by the communication service.
SR-26 (ANSP)	I	The ATSU end system shall be capable of detecting errors that would result in corruption introduced by the communication service.

B.3.1.3 Communication service provider (CSP)

Note.— The RCP allocations for the CSP are intended to aid the ANSP and the aircraft operator in the development of contracts and service agreements.

RCP communication transaction time and continuity criteria				
Specification: RCP 240/D		Application: CPDLC		Component: CSP
Transaction Time Parameter		ET (sec) C = 99.9%	TT (sec) C = 95%	Compliance means
RCTP Time Allocation				
RCTP_{CSP}		120	100	Contract/service agreement terms. Pre-implementation demonstration.

RCP availability criteria			
Specification: RCP 240/D	Application: CPDLC		Component: CSP
Availability parameter	Efficiency	Safety	Compliance means
Service availability (A_{CSP})	0.9999	0.999	Contract/service agreement terms
Unplanned outage duration limit (min)	10	10	Contract/service agreement terms
Maximum number of unplanned outages	4	48	Contract/service agreement terms
Maximum accumulated unplanned outage time (min/yr)	52	520	Contract/service agreement terms
Unplanned outage notification delay (min)	5	5	Contract/service agreement terms

Note.— DO-306/ED-122 specifies a requirement to indicate loss of the service. Unplanned outage notification delay is an additional time value associated with the requirement to indicate the loss to the ANSP per the RCP related safety requirement [SR-4](#) for the ANSP.

RCP integrity criteria			
Specification: RCP 240/D	Application: CPDLC		Component: CSP
Integrity parameter	Integrity value	Compliance means	
Integrity (I)	Not specified	Contract/service agreement terms. Per RCP related safety requirements SR-26 for the ANSP and SR-26 for the aircraft system, the end system is required include provisions, consistent with the overall RCP integrity criteria, to mitigate the effects of errors introduced by the network. These provisions require the network to pass protected information (or data) to the end system without manipulating the protected information (or data) it passes.	

Note.— In formulating contract terms with the CSP, the ANSP and/or operator may specify an integrity value and other related criteria, as appropriate, for the network, including subnetworks, that will ensure acceptable data integrity, consistent with the assumptions used to define the end system provisions (e.g. CRC or Fletcher's checksum).

B.3.1.4 Aircraft system

RCP communication transaction time and continuity criteria			
Specification: RCP 240/D	Application: CPDLC		Component: Aircraft system
Transaction Time Parameter	ET (sec) C = 99.9%	TT (sec) C = 95%	Compliance Means
RCP Time Allocation			
Initiator	30	30	Human-machine interface capability, pre-implementation demonstration
TRN Time Allocation			
Responder	60	60	Human-machine interface capability, pre-implementation demonstration
RCTP Time Allocation			
RCTP_{AIR}	15	10	Pre-implementation demonstration

RCP availability criteria			
Specification: RCP 240/D	Application: CPDLC		Component: Aircraft system
Availability parameter	Efficiency	Safety	Compliance means
A_{AIR}	N/A	0.999	Analysis, architecture, design, pre-implementation demonstration

RCP integrity criteria			
Specification: RCP 240/D	Application: CPDLC		Component: Aircraft system
Integrity parameter	Integrity value	Compliance means	
Integrity (I)	Malfunction = 10^{-5} per flight hour	Analysis, safety requirements, development assurance level (e.g. Level C software) commensurate with integrity level, pre-implementation demonstration. See also RCP related safety requirement SR-26 for the aircraft system.	

RCP monitoring and alerting criteria			
Specification: RCP 240/D		Application: CPDLC	Component: Aircraft system
Ref:	Criteria	Compliance means	
MA-1a	The aircraft system shall be capable of detecting aircraft system failures or loss of air/ground communication that would cause the aircraft communication capability to no longer meet the requirements for the intended function.	System design, implementation	
MA-1b	When the aircraft communication capability no longer meets the requirements for the intended function, the aircraft system shall provide indication to the flight crew.	System design, implementation	

RCP related safety requirements			
Specification: RCP 240/D		Application: CPDLC	Component: Aircraft system
Ref	Related RCP Parameter	Safety requirement	
SR-1a (Air)	A	The aircraft system shall provide to the ATSU an indication when it rejects a data link service request initiated by the ground system or the controller at the application layer.	
SR-1b (Air)	A	The aircraft system shall display the indication provided by the ATSU when a data link service request initiated by the flight crew is rejected at the application layer.	
SR-2 (Air)	A, C	The aircraft system shall indicate to the flight crew a detected loss of data link service.	
SR-5 (Air)	A, C	The aircraft system shall indicate to the flight crew when a message cannot be successfully transmitted.	
SR-6 (Air)	C, I	The aircraft end system shall provide unambiguous and unique identification of the origin and destination with each message it transmits.	
SR-7 (Air)	C, I	The aircraft system shall indicate in each response to which messages it refers.	
SR-8 (Air)	I	The aircraft shall execute the route clearance per the route clearance received from the ATSU via data link.	
SR-9 (Air)	C, I	The aircraft end system shall time stamp to within one second UTC each message when it is released for onward transmission.	
SR-1 (Air)0	C, I	The aircraft end system shall include in each ADS-C report the time at position to within one second of the UTC time the aircraft was actually at the position provided in the report.	
SR-11 (Air)	C, I	Any processing performed by aircraft system (data entry/ encoding/ transmitting/ decoding/ displaying) shall not affect the intent of the message	

RCP related safety requirements		
Specification: RCP 240/D		Application: CPDLC
		Component: Aircraft system
Ref	Related RCP Parameter	Safety requirement
SR-12 (Air)	C, I	The aircraft end system shall reject messages not addressed to itself.
SR-13 (Air)	C, I	The aircraft system shall transmit messages to the designated ATSU.
SR-15 (Air)	C, I	When the aircraft system receives a message whose time stamp exceeds ET_{TRN} , the aircraft system shall provide appropriate indication.
SR-16 (Air)	C, I	The aircraft end system shall prevent the release of responses to clearances without flight crew action.
SR-17 (Air)	C, I	The aircraft system shall prohibit operational processing by flight crew of corrupted messages.
SR-18 (Air)	C, I	The aircraft system shall be able to determine the message initiator.
SR-19 (Air)	C, I	The aircraft system shall prohibit to the flight crew operational processing of messages not addressed to the aircraft.
SR-21 (Air)	C, I	The aircraft identifiers sent by the aircraft system and used for data link initiation correlation shall be unique and unambiguous (e.g. the Aircraft Identification and either the Registration Marking or the Aircraft Address).
SR-24 (Air)	C, I	The aircraft system shall respond to messages in their entirety or allow the flight crew to do it.
SR-25 (Air)	I	The aircraft end system shall be capable of detecting errors that would result in misdelivery introduced by the communication service
SR-26 (Air)	I	The aircraft end system shall be capable of detecting errors that would result in corruption introduced by the communication service.
SR-27 (Air)	C, I	The aircraft and/or flight crew shall ensure the correct transfer into or out of the aircraft's FMS of route data received/sent via data link that will be used to define the aircraft active flight plan.

B.3.1.5 Aircraft operator

RCP communication transaction time and continuity criteria			
Specification: RCP 240/D	Application: CPDLC		Component: Aircraft operator
Transaction Time Parameter	ET (sec) C = 99.9%	TT (sec) C = 95%	Compliance Means
RCP Time Allocations			
Initiator	30	30	Procedures, flight crew training and qualification in accordance with safety requirements.
TRN Time Allocations			
Responder	60	60	Procedures, flight crew training and qualification in accordance with safety requirements.
RCTP Time Allocation			
RCTP_{AIR}	15	10	Aircraft type design approval, maintenance, properly configured user-modifiable software (e.g. owner requirements table)
RCTP_{CSP}	120	100	CSP contract/service agreement. See also paragraph B.3.1.3 . Pre-implementation demonstration.

RCP availability criteria			
Specification: RCP 240/D	Application: CPDLC		Component: Aircraft operator
Availability parameter	Efficiency	Safety	Compliance means
A_{AIR}	N/A	0.999	Aircraft type design approval, maintenance, properly configured user-modifiable software (e.g. owner requirements table or airline policy file).
Service availability (A_{CSP})	0.9999	0.999	Contract/service agreement terms. <i>Note.— For guidelines to aid in the development of the contract/service agreement with the CSP, see paragraph B.3.1.3, RCP 240/D allocation to CSP for RCP availability criteria.</i>

RCP integrity criteria		
Specification: RCP 240/D	Application: CPDLC	Component: Aircraft operator
Integrity parameter	Integrity value	Compliance means
Integrity (I)	Malfunction = 10^{-5} per flight hour	Aircraft type design approval, establish procedures, training, and qualification to meet safety requirements. CSP contract/service agreement. See also RCP integrity criteria for CSP, paragraph B.3.1.3 .

RCP monitoring and alerting criteria		
Specification: RCP 240/D	Application: CPDLC	Component: Aircraft operator
Ref:	Criteria	Compliance means
MA-2	When the flight crew determines that the aircraft communication capability no longer meets the requirements for the intended function, the flight crew shall advise the ATC unit concerned.	Procedures, flight crew training and qualification

RCP related safety requirements		
Specification: RCP 240/D	Application: CPDLC	Component: Aircraft operator
Ref	Related RCP Parameter	Safety requirement
SR-22 (Operator)	C, I	The flight crew shall perform the initiation data link procedure again with any change of the flight identifier.
SR-24 (Operator)	C, I	The flight crew shall respond to a message in its entirety when not responded by the aircraft system.
SR-27 (Operator)	C, I	The aircraft and/or flight crew shall ensure the correct transfer into or out of the aircraft's FMS of route data received/sent via data link that will be used to define the aircraft active flight plan.

B.4 RCP 400 specification

RCP Specification			
RCP specification		RCP 400	
Airspace specific considerations			
Interoperability	Specify interoperability criteria (e.g. FANS 1/A)		
ATS Function	Specify ATS function(s) (e.g. applicable separation standard)		
Application	Specify controller-pilot ATC communication intervention capability (e.g. CPDLC application per ICAO Doc 4444, and RTCA DO-306/EUROCAE ED-122, Annex A)		
RCP parameter values			
Transaction time (sec)	Continuity (C)	Availability (A)	Integrity (I)
ET = 400	C(ET) = 0.999	0.999	Malfunction = 10^{-5} per flight hour
TT 95% = 350	C(TT 95%) = 0.95		
RCP monitoring and alerting criteria			
Ref:	Criteria		
MA-1	The system shall be capable of detecting failures and configuration changes that would cause the communication service to no longer meet the RCP specification for the intended function.		
MA-2	When the communication service can no longer meet the RCP specification for the intended function, the flight crew and/or the controller shall take appropriate action.		
Notes			
<i>Note 1.— Rationale for the criteria provided in this specification can be found in ICAO Annex 11, ICAO Doc 4444, ICAO Doc 9689, and RTCA DO-306/ED-122.</i>			
<i>Note 2.— The values for transaction times are to be applied to transactions that are representative of communication capability for the controller to intervene with a specific operator, aircraft type, and aircraft identification.</i>			
<i>Note 3.— If changes are made to the system capacity limits, as specified by the airspace requirements, and the changes cause the system to perform below the RCP specification, this would be considered a change in system configuration.</i>			

B.4.1 RCP 400/D allocations

B.4.1.1 General

B.4.1.1.1 The RCP 400/D allocations are applicable to the CPDLC application.

B.4.1.2 Air navigation service provider (ANSP)

RCP communication transaction time and continuity criteria			
Specification: RCP 400/D	Application: CPDLC		Component: ANSP
Transaction Time Parameter	ET (sec) C = 99.9%	TT (sec) C = 95%	Compliance Means
Transaction Time Value	400	350	Analysis, CSP contract/service agreement. See also paragraph B.4.1.3 .
RCP Time Allocations			
Initiator	30	30	Analysis, simulations, safety and human factors assessments
TRN	370	320	Monitored, CSP contract/service agreement. See also paragraph B.4.1.3 .
TRN Time Allocations			
Responder	60	60	Initially, by analysis, simulations, safety human factors assessments Post-implementation, monitored, estimated
RCTP	310	260	Monitored, estimated, CSP contract/service agreement. See also paragraph B.4.1.3 .
RCTP Time Allocation			
RCTP_{ATSU}	15	10	Pre-implementation demonstration

RCP availability criteria			
Specification: RCP 400/D	Application: CPDLC		Component: ANSP
Availability parameter	Efficiency	Safety	Compliance means
Service availability (A_{CSP})	N/A	0.999	Contract/service agreement terms, <i>Note.</i> — For guidelines to aid in the development of the contract/service agreement with the CSP, see paragraph B.4.1.3 , RCP 400/D allocation to CSP for RCP availability criteria.

RCP integrity criteria		
Specification: RCP 400/D	Application: CPDLC	Component: ANSP
Integrity parameter	Integrity value	Compliance means
Integrity (I)	<i>Note.— RCP integrity criteria related to RCP 400/D are the same as those related to RCP 240/D. See paragraph B.3.1.2.</i>	

RCP monitoring and alerting criteria		
Specification: RCP 400/D	Application: CPDLC	Component: ANSP
Ref:	Criteria	Compliance means
All	<i>Note.— RCP monitoring and alerting criteria related to RCP 400/D are the same as those related to RCP 240/D. See paragraph B.3.1.2.</i>	

RCP related safety requirements		
Specification: RCP 400/D	Application: CPDLC	Component: ANSP
Ref	Related RCP Parameter	Safety requirement
All	A, C, I	<i>Note.— Safety requirements related to RCP 400/D are the same as those related to RCP 240/D. See paragraph B.3.1.2.</i>

B.4.1.3 Communication service provider (CSP)

Note.— The RCP allocations for the CSP are intended to aid the ANSP and the aircraft operator in the development of contracts and service agreements.

RCP communication transaction time and continuity criteria			
Specification: RCP 400/D	Application: CPDLC		Component: CSP
Transaction Time Parameter	ET (sec) C = 99.9%	TT (sec) C = 95%	Compliance means
RCTP Time Allocation			
RCTP _{CSP}	280	240	Contract/service agreement terms

RCP availability criteria			
Specification: RCP 400/D	Application: CPDLC	Component: CSP	
Availability parameter	Efficiency	Safety	Compliance means
Service availability (A_{CSP})	N/A	0.999	Contract/service agreement terms
Unplanned outage duration limit (min)	N/A	20	Contract/service agreement terms
Maximum number of unplanned outages	N/A	24	Contract/service agreement terms
Maximum accumulated unplanned outage time (min/yr)	N/A	520	Contract/service agreement terms
Unplanned outage notification delay (min)	N/A	10	Contract/service agreement terms

RCP integrity criteria		
Specification: RCP 400/D	Application: CPDLC	Component: CSP
Integrity parameter	Integrity value	Compliance means
Integrity (I)	<i>Note.— RCP integrity criteria related to RCP 400/D are the same as those related to RCP 240/D. See paragraph B.3.1.3.</i>	

B.4.1.4 Aircraft system

RCP communication transaction time and continuity criteria			
Specification: RCP 400/D	Application: CPDLC		Component: Aircraft system
Transaction Time Parameter	ET (sec) C = 99.9%	TT (sec) C = 95%	Compliance Means
RCP Time Allocation			
Initiator	30	30	Human-machine interface capability, pre-implementation demonstration
TRN Time Allocation			
Responder	60	60	Human-machine interface capability, pre-implementation demonstration
RCTP Time Allocation			
RCTP _{AIR}	15	10	Pre-implementation demonstration

RCP availability criteria			
Specification: RCP 400/D	Application: CPDLC		Component: Aircraft system
Availability parameter	Efficiency	Safety	Compliance means
A _{AIR}	N/A	0.999	Analysis, architecture, design, pre-implementation demonstration

RCP integrity criteria		
Specification: RCP 400/D	Application: CPDLC	Component: Aircraft system
Integrity parameter	Integrity value	Compliance means
Integrity (I)	<i>Note.— RCP integrity criteria related to RCP 400/D are the same as those related to RCP 240/D. See paragraph B.3.1.4.</i>	

RCP monitoring and alerting criteria		
Specification: RCP 400/D	Application: CPDLC	Component: Aircraft system
Ref:	Criteria	Compliance means
All	<i>Note.— RCP monitoring and alerting criteria related to RCP allocations 400/D are the same as those related to RCP 240/D. See paragraph B.3.1.4.</i>	

RCP related safety requirements		
Specification: RCP 400/D	Application: CPDLC	Component: Aircraft system
Ref	Related RCP Parameter	Safety requirement
All	A, C, I	<i>Note.— Safety requirements related to RCP 400/D are the same as those related to RCP 240/D. See paragraph B.3.1.4.</i>

B.4.1.5 Aircraft operator

RCP communication transaction time and continuity criteria			
Specification: RCP 400/D	Application: CPDLC		Component: Aircraft operator
Transaction Time Parameter	ET (sec) C = 99.9%	TT (sec) C = 95%	Compliance Means
RCP Time Allocations			
Initiator	30	30	Procedural capability, flight crew training and qualification in accordance with safety requirements.
TRN Time Allocations			
Responder	60	60	Procedural capability, flight crew training and qualification in accordance with safety requirements.
RCTP Time Allocation			
RCTP_{AIR}	15	10	Aircraft type design approval, maintenance, properly configured user-modifiable software (e.g. owner requirements table)
RCTP_{CSP}	280	240	CSP contract/service agreement. See also paragraph B.4.1.3 .

RCP availability criteria			
Specification: RCP 400/D	Application: CPDLC		Component: Aircraft operator
Availability parameter	Efficiency	Safety	Compliance means
A_{AIR}	N/A	0.999	Aircraft type design approval, maintenance, properly configured user-modifiable software (e.g. owner requirements table)
Service availability (A_{CSP})	N/A	0.999	Contract/service agreement terms. <i>Note.</i> — For guidelines to aid in the development of the contract/service agreement with the CSP, see paragraph B.4.1.3 , RCP 400/D allocation to CSP for RCP availability criteria.

RCP integrity criteria		
Specification: RCP 400/D	Application: CPDLC	Component: Aircraft operator
Integrity parameter	Integrity value	Compliance means
Integrity (I)	<i>Note.— RCP integrity criteria related to RCP 400/D are the same as those related to RCP 240/D. See paragraph B.3.1.5.</i>	

RCP monitoring and alerting criteria		
Specification: RCP 400/D	Application: CPDLC	Component: Aircraft operator
Ref:	Criteria	Compliance means
All	<i>Note.— RCP monitoring and alerting criteria related to RCP 400/D are the same as those related to RCP 240/D. See paragraph B.3.1.5.</i>	

RCP related safety requirements		
Specification: RCP 400/D	Application: CPDLC	Component: Aircraft operator
Ref	Related RCP Parameter	Safety requirement
All	C, I	<i>Note.— Safety requirements related to RCP 400/D are the same as those related to RCP 240/D. See paragraph B.3.1.5.</i>

Appendix C RSP specifications

C.1 General

C.1.1 This appendix includes specifications for RSP 180 and RSP 400. These specifications support:

- a) Safety oversight of air traffic service provisions and operations;
- b) Agreements/contractual arrangements that ANSPs and aircraft operators make with their respective CSPs;
- c) Operational authorizations, flight crew training and qualification;
- d) Design approval of aircraft data link systems; and
- e) Operational-monitoring, analysis, and exchange of operational data among regions and states.

C.1.2 The RSP specifications are derived mainly from a safety assessment. However, in cases where it has been determined to be beneficial, the RSP specification may include criteria to support operational efficiency and orderly flow of air traffic. In these cases, the RSP specification indicates the distinction between safety and efficiency.

C.1.3 The RSP specifications provide a means of compliance, in general. Additional guidance related to service provision, aircraft approval and operational authorizations can be found in [Chapter 3](#). Guidance and requirements on post-implementation monitoring can be found at [Appendix D](#).

C.1.4 The RSP specifications include allocations for data communications. The /D designator is used to indicate the RSP allocations associated with the ADS-C or FMC WPR application.

C.2 Terms and acronyms

Note.— The terms applied to the RSP specifications are derived from ICAO Doc 9869, First Edition, Manual on Required Communication Performance, dated 2008 and ICAO Doc 9613, Performance Based Navigation Manual. Additional terms are provided, as appropriate, to clarify meaning and measurement points for the RSP allocations.

RSP specification	
Term	Description
ATS surveillance service	A term used to indicate a service provided directly by means of an ATS surveillance system. (ICAO)
ADS-C service	A term used to indicate an ATS service that provides surveillance information by means of the ADS-C application. <i>Note.— ICAO Doc 4444 does not include ADS-C in its definition for ATS surveillance system. Therefore, an ATS surveillance service does not consider those provided by means of the ADS-C application, unless it can be shown by comparative assessment to have a level of safety and performance equal to or better than monopulse SSR.</i>

RSP specification	
Term	Description
FMC WPR service	A term used to indicate an ATS service that provides surveillance information by means of the FMC WPR application. <i>Note.</i> — ICAO Doc 4444 does not include FMC WPR in its definition for ATS surveillance system. Therefore, an ATS surveillance service does not consider those provided by means of the FMC WPR application, unless it can be shown by comparative assessment to have a level of safety and performance equal to or better than monopulse SSR.
ATS surveillance system	A generic term meaning variously, ADS-B, PSR, SSR or any comparable ground-based system that enables the identification of aircraft. <i>Note.</i> — A comparable ground-based system is one that has been demonstrated, by comparative assessment or other methodology, to have a level of safety and performance equal to or better than monopulse SSR. (ICAO)
Automatic surveillance (ADS-B) — dependent broadcast	A means by which aircraft, aerodrome vehicles and other objects can automatically transmit and/or receive data such as identification, position and additional data, as appropriate, in a broadcast mode via a data link. (ICAO)
Automatic surveillance (ADS-C) — dependent contract	A means by which the terms of an ADS-C agreement will be exchanged between the ground system and the aircraft, via a data link, specifying under what conditions ADS-C reports would be initiated, and what data would be contained in the reports. <i>Note.</i> — The abbreviated term “ADS contract” is commonly used to refer to ADS event contract, ADS demand contract, ADS periodic contract or an emergency mode. (ICAO)
Surveillance data	Data pertaining to the identification of aircraft and/or obstructions for route conformance monitoring and safe and efficient conduct of flight. <i>Note.</i> — In this document, surveillance data applies to ADS-C reports, CPDLC position reports and FMC waypoint position reports.
Required surveillance performance (RSP)	A statement of the performance requirements for operational surveillance in support of specific ATM functions.
RSP specification	A set of ATS provision, including communication services, aircraft and operator requirements (e.g. RSP 180) needed for surveillance supporting a performance-based operation within a defined airspace.

RSP specification	
Term	Description
Surveillance data delivery	The process for obtaining surveillance data. <i>Note.</i> — <i>In this document, the delivery is defined for the following reports:</i> a) <i>ADS-C periodic report, from the start of the periodic interval to when the ATSU receives the report. The start of the periodic interval occurs when the periodic report is sent by the aircraft/flight crew;</i> b) <i>ADS-C event reports and FMC waypoint position reports, from the time the aircraft system detects that the event has occurred to when the ATSU receives the report; and</i> c) <i>CPDLC position report, from the time at which the aircraft reported its position and when the ATSU receives the report.</i>
RSP data transit time	The required time for surveillance data delivery.
RSP overdue delivery time (OT)	The maximum time for the successful delivery of surveillance data after which the initiator is required to revert to an alternative procedure.
RSP nominal delivery time (DT 95%)	The maximum nominal time within which 95% of surveillance data is required to be successfully delivered.
RSP continuity (C)	The required probability that surveillance data can be delivered within the surveillance delivery time parameter, either OT or DT 95%, given that the service was available at the start of delivery.
RSP availability (A)	The required probability that surveillance data can be provided when needed.
RSP integrity (I)	The required probability that the surveillance data is delivered with no undetected error. <i>Note.</i> — <i>Surveillance integrity includes such factors as the accuracy of time, correlating the time at aircraft position, reporting interval, data latency, extrapolation and/or estimation of the data.</i>

RSP data transit time	
Term	Description
RSTP _{ATSU}	The overdue (OD) or nominal (DT) transit time for surveillance data from the CSP interface to the ATSU's flight data processing system.
RSTP _{AIR}	The overdue (OD) or nominal (DT) transit time for surveillance data from the aircraft's avionics to the antenna.
RSTP _{CSP}	The overdue (OD) or nominal (DT) transit time for surveillance data allocated to the CSP.

RSP continuity	
Term	Description
C for RSTP _{ATSU}	The proportion of surveillance messages that can be delivered within the specified RSTP _{ATSU} .
C for RSTP _{AIR}	The proportion of surveillance messages that can be delivered within the specified RSTP _{AIR} .
C for RSTP _{CSP}	The proportion of surveillance messages that can be delivered within the specified RSTP _{CSP} .

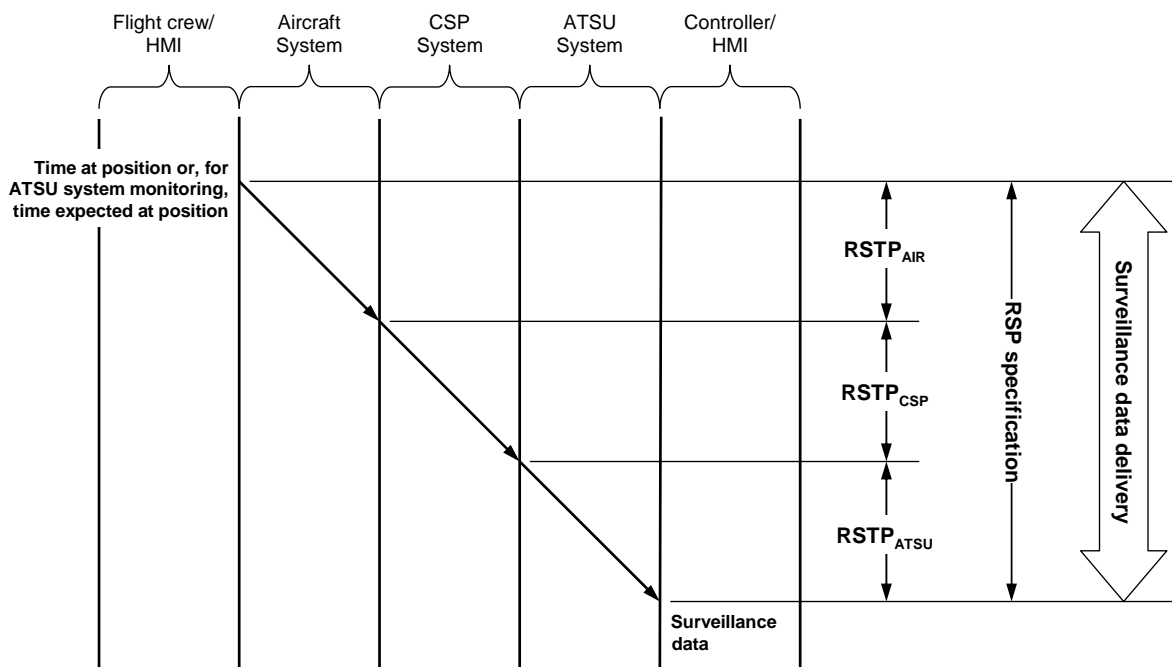

Note.— The terms and acronyms used to specify the criteria for surveillance availability are the same as the terms and acronyms used to specify the criteria for RCP availability. See [Appendix B, paragraph B.2](#).

C.3 RSP 180 specification

RSP specification				
RSP specification			RSP 180	
Airspace specific considerations				
Interoperability	Specify interoperability criteria (e.g. FANS 1/A)			
ATS Function	Specify ATS function(s) (e.g. applicable separation standard)			
Application	Specify the required surveillance capability. FMC WPR or, for ADS-C, specify the types of contracts required to support the ATS function (e.g. periodic contract at [nn] min, waypoint change event contract, lateral deviation event contract at [n] NM).			
RSP parameter values				
Transit time (sec)	Continuity (C)	Availability (A)	Integrity (I)	
OT = 180	C(OT) = 0.999	0.999 0.9999 (efficiency) <i>See Note 3.</i>	Navigation FOM	<i>See Note 4.</i>
DT 95% = 90	C(DT 95%) = 0.95		Time at position accuracy	+/- 1 sec (UTC)
			Data integrity	Malfunction = 10^{-5} per flight hour
RSP monitoring and alerting criteria				
Ref	Criteria			
MA-1	The system shall be capable of detecting failures and configuration changes that would cause the ADS-C or FMC WPR service to no longer meet the surveillance parameter values for the intended function.			
MA-2	When the ADS-C or FMC WPR service can no longer meet the surveillance parameter values for the intended function, the flight crew and/or the controller shall take appropriate action.			
Notes				
<i>Note 1.— Rationale for the criteria provided in this specification can be found in ICAO Annex 11, ICAO Doc 4444, ICAO Doc 9689, and RTCA DO-306/ED-122.</i>				
<i>Note 2.— If changes are made to the system capacity limits, as specified by the airspace requirements, and the changes cause the system to perform below the surveillance parameter values, this would be considered a change in system configuration.</i>				
<i>Note 3.— DO-306/ED-122 specifies an availability value based on safety assessment of the operational effects of the loss of the service. The availability value herein is more stringent, based on an additional need to maintain orderly and efficient operations.</i>				
<i>Note 4.— The navigation figure of merit (FOM) is specified based on the navigation criteria associated with this spec. For example, if RNP 4 is prescribed, then for ADS-C surveillance service, the FOM level would need to be 4 or higher. In all cases, when the navigation capability no longer meets the criteria specified for the operation, the flight crew is responsible for reporting the non-compliance to ATC in accordance with ICAO procedures.</i>				

C.3.1 RSP 180/D allocations

C.3.1.1 General

C.3.1.1.1 The RSP 180/D allocations can be applied to the ADS-C or FMC WPR applications.

C.3.1.2 Air navigation service provider (ANSP)

RSP data transit time and continuity criteria			
Specification: RSP 180/D	Application: ADS-C, FMC WPR		Component: ANSP
Data Latency Parameter	OT (sec) C = 99.9%	DT 95%(sec) C = 95%	Compliance Means
Delivery Time Value	180	90	Analysis, CSP contract/service agreement. See also paragraph C.3.1.3 .
RSTP Time Allocation			
RSTP _{ATSU}	5	3	Pre-implementation demonstration

RSP availability criteria			
Specification: RSP 180/D	Application: ADS-C, FMC WPR		Component: ANSP
Availability parameter	Efficiency	Safety	Compliance means
Service availability (A_{CSP})	0.9999	0.999	Contract/service agreement terms. <i>Note.</i> — For guidelines to aid in the development of the contract/service agreement with the CSP, see paragraph C.3.1.3 , RSP 180/D allocation to CSP for surveillance availability criteria.

RSP integrity criteria		
Specification: RSP 180/D	Application: ADS-C, FMC WPR	Component: ANSP
Integrity parameter	Integrity value	Compliance means
Integrity (I)	Malfunction = 10^{-5} per flight hour	Analysis, safety requirements, development assurance level commensurate with integrity level, (compliance shown prior to operational implementation). See also related safety requirement SR-26 for the ANSP. CSP contract/service agreement. See also surveillance integrity criteria for CSP, paragraph C.3.1.3 .

RSP monitoring and alerting criteria		
Specification: RSP 180/D	Application: ADS-C, FMC WPR	Component: ANSP
Ref:	Criteria	Compliance means
MA-1a	The ground system shall be capable of detecting ground system failures and configuration changes that would cause the ADS-C or FMC WPR service to no longer meet the requirements for the intended function. <i>Note.— If changes are made to the system capacity limits, as specified by the airspace requirements, and the changes cause the system to perform below the RSP specification, this would be considered a change in system configuration.</i>	System design, implementation. CSP contract/service agreement. See also paragraph C.3.1.3 , surveillance availability criteria.
MA-1b	When the ADS-C or FMC WPR service no longer meets the requirements for the intended function, the ground system shall provide indication to the controller.	System design, implementation. CSP contract/service agreement. See also paragraph C.3.1.3 , surveillance availability criteria.
MA-2	When the controller receives an indication that the ADS-C or FMC WPR service no longer meets the requirements for the intended function (e.g. reduced longitudinal separation), the controller shall take action to resolve the situation, (e.g. apply an alternative form of separation).	System design, procedures, implementation

RSP related safety requirements		
Specification: RSP 180/D	Application: ADS-C, FMC WPR	Component: ANSP
Ref	Related Surveillance Parameter	Safety requirement
All	A, C, I	<i>Note.— Safety requirements related to RSP 180/D are the same as those related to RCP 240/D, unless otherwise modified in this table. See Appendix B, paragraph B.3.1.2.</i>

C.3.1.3 Communication service provider (CSP)

Note.— The RSP allocations for the CSP are intended to aid the ANSP and the aircraft operator in the development of contracts and service agreements.

RSP data transit time and continuity criteria			
Specification: RSP 180/D	Application: ADS-C, FMC WPR		Component: CSP
Data Latency Parameter	OT (sec) C = 99.9%	DT 95% (sec) C = 95%	Compliance means
RSTP Time Allocation			
RSTP _{CSP}	170	84	Contract/service agreement terms. Pre-implementation demonstration

RSP availability criteria			
Specification: RSP 180/D	Application: ADS-C, FMC WPR		Component: CSP
Availability parameter	Efficiency	Safety	Compliance means
Service availability (A_{CSP})	0.9999	0.999	Contract/service agreement terms
Unplanned outage duration limit (min)	10	10	Contract/service agreement terms
Maximum number of unplanned outages	4	48	Contract/service agreement terms
Maximum accumulated unplanned outage time (min/yr)	52	520	Contract/service agreement terms
Unplanned outage notification delay (min)	5	5	Contract/service agreement terms
<i>Note.</i> — The RSP availability criteria for RSP 180/D are the same as those provided for RCP 240/D. See Appendix B, paragraph B.3.1.3 .			

RSP integrity criteria		
Specification: RSP 180/D	Application: ADS-C, FMC WPR	Component: CSP
Integrity parameter	Integrity value	Compliance means
Integrity (I)	Not specified	<p>Contract/service agreement terms. Per surveillance related safety requirements SR-26 for the ANSP and SR-26 for the aircraft system, the end system is required include provisions, consistent with the overall data integrity criteria, to mitigate the effects of errors introduced by the network. These provisions require the network to pass protected information (or data) to the end system without manipulating the protected information (or data) it passes.</p> <p><i>Note.— In formulating contract terms with the CSP, the ANSP and/or operator may specify an integrity value and other related criteria, as appropriate, for the network, including subnetworks, that will ensure acceptable data integrity, consistent with the assumptions used to define the end system provisions (e.g. CRC or Fletcher's checksum).</i></p>

C.3.1.4 Aircraft system

RSP data transit time and continuity criteria			
Specification: RSP 180/D	Application: ADS-C, FMC WPR		Component: Aircraft system
Data Latency Parameter	OT (sec) C = 99.9%	DT 95%(sec) C = 95%	Compliance Means
RSTP Time Allocation			
RSTP _{AIR}	5	3	Pre-implementation demonstration

RSP availability criteria			
Specification: RSP 180/D	Application: ADS-C, FMC WPR		Component: Aircraft system
Availability parameter	Efficiency	Safety	Compliance means
A _{AIR} (probability)	N/A	0.999	Analysis, architecture, design, pre-implementation demonstration
<i>Note.— The surveillance availability criteria for RSP 180/D are the same as those provided for RCP 240/D. See Appendix B, paragraph B.3.1.4.</i>			

RSP integrity criteria		
Specification: RSP 180/D	Application: ADS-C, FMC WPR	Component: Aircraft system
Integrity parameter	Integrity value	Compliance means
Integrity (I)	Malfunction = 10^{-5} per flight hour	Analysis, safety requirements, development assurance level (e.g. Level C software) commensurate with integrity level, pre-implementation demonstration. See also related safety requirement SR-26 for the aircraft system.

RSP monitoring and alerting criteria		
Specification: RSP 180/D	Application: ADS-C, FMC WPR	Component: Aircraft system
Ref:	Criteria	Compliance means
MA-1a	The aircraft system shall be capable of detecting aircraft system failures or loss of air/ground communication that would cause the aircraft surveillance capability to no longer meet the requirements for the intended function.	System design, implementation
MA-1b	When the aircraft surveillance capability no longer meets the requirements for the intended function, the aircraft system shall provide indication to the flight crew.	System design, implementation

RSP related safety requirements		
Specification: RSP 180/D	Application: ADS-C, FMC WPR	Component: Aircraft system
Ref	Related Surveillance Parameter	Safety requirement
All	A, C, I	<i>Note.— Safety requirements related to RSP 180/D are the same as those related to RCP 240/D, unless otherwise modified in this table. See Appendix B, paragraph B.3.1.4.</i>

C.3.1.5 Aircraft operator

RSP data transit time and continuity criteria			
Specification: RSP 180/D	Application: ADS-C, FMC WPR		Component: Aircraft operator
Data Latency Parameter	OT (sec) C = 99.9%	DT 95% (sec) C = 95%	Compliance Means
RSTP			
RSTP_{AIR}	5	3	Aircraft type design approval, maintenance, properly configured user-modifiable software (e.g. owner requirements table)
RSTP_{CSP}	170	84	CSP contract/service agreement. See also paragraph C.3.1.3 . Pre-implementation demonstration.

RSP availability criteria			
Specification: RSP 180/D	Application: ADS-C, FMC WPR		Component: Aircraft operator
Availability parameter	Efficiency	Safety	Compliance means
A_{AIR} (probability)	N/A	0.999	Aircraft type design approval, maintenance, properly configured user-modifiable software (e.g. owner requirements table or airline policy file).
Service availability (A_{CSP})	0.9999	0.999	Contract/service agreement terms. <u>Note.</u> — For guidelines to aid in the development of the contract/service agreement with the CSP, see paragraph C.3.1.3 , RSP 180/D allocation to CSP for surveillance availability criteria.

RSP integrity criteria		
Specification: RSP 180/D	Application: ADS-C, FMC WPR	Component: Aircraft operator
Integrity parameter	Integrity value	Compliance means
Integrity (I)	Malfunction = 10^{-5}	Aircraft type design approval, establish procedures, training, and qualification to meet safety requirements. CSP contract/service agreement. See also surveillance integrity criteria for CSP, paragraph C.3.1.3 .

RSP monitoring and alerting criteria		
Specification: RSP 180/D	Application: ADS-C, FMC WPR	Component: Aircraft operator
Ref:	Criteria	Compliance means
MA-2	When the flight crew determines that the aircraft surveillance capability no longer meets the requirements for the intended function, the flight crew shall advise the ATC unit concerned.	Procedures, flight crew training and qualification

RSP related safety requirements		
Specification: RSP 180/D	Application: ADS-C, FMC WPR	Component: Aircraft operator
Ref	Related Surveillance Parameter	Safety requirement
All	C, I	<i>Note.— Safety requirements related to RSP 180/D are the same as those related to RCP 240/D. See Appendix B, paragraph B.3.1.5.</i>

C.4 RSP 400 specification

RSP specification					
RSP specification			RSP 400		
Airspace specific considerations					
Interoperability	Specify interoperability criteria (e.g. FANS 1/A)				
ATS Function	Specify ATS function(s) (e.g. applicable separation standard)				
Application	Specify the required surveillance capability. FMC WPR or, for ADS-C, specify the types of contracts required to support the ATS function (e.g. periodic contract at [nn] min, waypoint change event contract, lateral deviation event contract at [n] NM).				
Surveillance parameter values					
Transit time (sec)	Continuity (C)		Availability (A)	Integrity (I)	
OT = 400	C(OT) = 0.999		0.999	Navigation FOM	See <i>Note 3</i> .
DT 95% = 300	C(DT 95%) = 0.95			Time at position accuracy	+/- 1 sec (UTC)
				Data integrity	Malfunction = 10^{-5} per flight hour
Surveillance monitoring and alerting criteria					
Ref	Criteria				
MA-1	The system shall be capable of detecting failures and configuration changes that would cause the ADS-C or FMC WPR service to no longer meet the surveillance parameter values for the intended function.				
MA-2	When the ADS-C or FMC WPR service can no longer meet the surveillance parameter values for the intended function, the flight crew and/or the controller shall take appropriate action.				
Notes					
<i>Note 1.</i> — Rationale for the criteria provided in this specification can be found in ICAO Annex 11, ICAO Doc 4444, ICAO Doc 9689, and RTCA DO-306/ED-122.					
<i>Note 2.</i> — If changes are made to the system capacity limits, as specified by the airspace requirements, and the changes cause the system to perform below the surveillance parameter values, this would be considered a change in system configuration.					
<i>Note 3.</i> — The navigation figure of merit (FOM) is specified based on the navigation criteria associated with this spec. For example, if RNP 10 is prescribed, then for ADS-C surveillance service, the FOM level would need to be 3 or higher. In all cases, when the navigation capability no longer meets the criteria specified for the operation, the flight crew is responsible for reporting the non-compliance to ATC in accordance with ICAO procedures.					

C.4.1 RSP 400/D allocations

C.4.1.1 General

C.4.1.1.1 The RSP 400/D allocations can be applied to the ADS-C or FMC WPR applications.

C.4.1.2 Air navigation service provider (ANSP)

RSP data transit time and continuity criteria			
Specification: RSP 400/D	Application: ADS-C, FMC WPR		Component: ANSP
Data Latency Parameter	OT (sec) C = 99.9%	DT 95% (sec) C = 95%	Compliance Means
Delivery Time Value	400	300	Analysis, CSP contract/service agreement. See also paragraph C.4.1.3 .
RSTP Time Allocation			
RSTP _{ATSU}	30	15	Pre-implementation demonstration

RSP availability criteria			
Specification: RSP 400/D	Application: ADS-C, FMC WPR		Component: ANSP
Availability parameter	Efficiency	Safety	Compliance means
Service availability (A _{CSP})	N/A	0.999	Contract/service agreement terms. <i>Note.</i> — For guidelines to aid in the development of the contract/service agreement with the CSP, see paragraph C.4.1.3 , RSP 180/D allocation to CSP for surveillance availability criteria.

Note.— The RSP integrity criteria, monitoring and alerting criteria, and related safety requirements for RSP 400/D are the same as the criteria provided for RSP 180/D. See [paragraph C.3.1.2](#).

C.4.1.3 Communication service provider (CSP)

Note.— The RSP allocations for the CSP are intended to aid the ANSP and the aircraft operator in the development of contracts and service agreements.

RSP data transit time and continuity criteria			
Specification: RSP 400/D	Application: ADS-C, FMC WPR		Component: CSP
Data Latency Parameter	OT (sec) C = 99.9%	DT 95% (sec) C = 95%	Compliance Means
RSTP Time Allocation			
RSTP _{CSP}	340	270	Contract/service agreement terms. Pre-implementation demonstration

RSP availability criteria			
Specification: RSP 400/D	Application: ADS-C, FMC WPR		Component: CSP
Availability parameter	Efficiency	Safety	Compliance means
Service availability (A_{CSP})	N/A	0.999	Contract/service agreement terms
Unplanned outage duration limit (min)	N/A	20	Contract/service agreement terms
Maximum number of unplanned outages	N/A	24	Contract/service agreement terms
Maximum accumulated unplanned outage time (min/yr)	N/A	520	Contract/service agreement terms
Unplanned outage notification delay (min)	N/A	10	Contract/service agreement terms
<i>Note.— The RSP availability criteria for RSP 400/D are the same as those provided for RCP 400/D. See Appendix B, paragraph B.4.1.3.</i>			

RSP integrity criteria		
Specification: RSP 400/D	Application: ADS-C, FMC WPR	Component: CSP
Integrity parameter	Integrity value	Compliance means
Integrity (I)	<i>Note.— RSP integrity criteria related to RSP 400/D are the same as those related to RSP 180/D. See paragraph C.3.1.3.</i>	

C.4.1.4 Aircraft system

RSP data transit time and continuity criteria			
Specification: RSP 400/D	Application: ADS-C, FMC WPR		Component: Aircraft system
Data Latency Parameter	OT (sec) C = 99.9%	DT 95% (sec) C = 95%	Compliance Means
RSTP Time Allocation			
RSTP_{AIR}	30	15	Pre-implementation demonstration

Note.— The RSP availability, integrity and monitoring and alerting criteria, and related safety requirements for RSP 400/D are the same as the criteria and related safety requirements provided for RSP 180/D. See [paragraph C.3.1.4](#).

C.4.1.5 Aircraft operator

RSP data transit time and continuity criteria			
Specification: RSP 400/D	Application: ADS-C, FMC WPR		Component: Aircraft operator
Data Latency Parameter	OT (sec) C = 99.9%	DT 95% (sec) C = 95%	Compliance Means
RSTP Time Allocation			
RSTP_{AIR}	30	15	Aircraft type design approval, maintenance, properly configured user-modifiable software (e.g. owner requirements table)
RSTP_{CSP}	340	270	CSP contract/service agreement. See also paragraph C.4.1.3 . Pre-implementation demonstration.

Note.— The RSP availability, integrity and monitoring and alerting criteria, and related safety requirements for RSP 400/D are the same as the criteria and related safety requirements provided for RSP 180/D. See [paragraph C.3.1.5](#).

Appendix D Post-implementation monitoring and corrective action

D.1 General

D.1.1 The ICAO Global Plan calls for the implementation of a performance based system and ICAO Annex 11 requires that data link system performance is monitored to verify that an acceptable level of safety continues to be met. Annex 11 at paragraph 2.2.7.5 states:

“Any significant safety-related change to the ATC system, including the implementation of a reduced separation minimum or a new procedure, shall only be effected after a safety assessment has demonstrated that an acceptable level of safety will be met and users have been consulted. When appropriate, the responsible authority shall ensure that adequate provision is made for post-implementation monitoring to verify that the defined level of safety continues to be met.”

D.1.2 For continental European airspace, EC Regulation 29/2009 (the DLS IR) stipulates:

“The quality of service of air-ground data link communications should be regularly monitored by ATS Providers”.

D.1.3 It also states:

“ATS providers shall monitor the quality of service of communication services and verify their conformance with the level of performance required”.

D.1.4 The CPDLC system, data link system (ATN or FANS 1/A) and A/G radio links (SATCOM, VDL M2, etc) must operate successfully as a whole to ensure smooth CPDLC operations and to verify that an acceptable level of safety continues to be met. As such a *central* function performing the overall monitoring of normal data link operations, service disruptions and restorations not only at the level of communication service provision but also at CPDLC, data link system and A/G radio link level, will be needed to:

- guarantee performance and inter-operability;
- investigate problems;
- share lessons learned.

D.1.5 Without such a central function this may prove difficult to achieve. This function will need to continue once the data link service is in place to guarantee capacity, performance and inter-operability in the years following successful implementation.

D.1.6 Oversight of the compliance to the Annex 11 requirements is a matter for the States. However, States participate in planning and implementation regional groups (PIRGs), and most use a regional monitoring agency to facilitate monitoring activities within their respective region. The individual states/ANSPs will need to provide the data and information and analysis that will portray regional performance measures. The ANSPs, operators, CSPs, airframe manufacturers, and equipment suppliers all need to participate in reporting and resolving problems associated among the ANSPs and with aircraft.

D.1.7 While individual ANSP will develop the data collection mechanisms, monitoring tools, and internal reporting requirements best suiting their own environment, all ANSP should collect and maintain a database of performance data using the data formats specified in this appendix. These databases will provide the means to aggregate ADS-C surveillance transit time and CPDLC RCP transaction time on a regional and global basis.

D.1.8 Monitoring of data communications performance in terms of RCP and RSP is an important part of the performance based system described in the ICAO global plan. To successfully achieve this performance monitoring on a global scale will require the use of a common data set. It is only through this common data set that RCP and RSP data can be aggregated from an ANSP level through to a regional monitoring agency level and then to global level. This aggregation of performance data is in accordance with the guidelines provided in ICAO Doc 9883 Manual on Global Performance of the Air Navigation System.

D.1.9 In addition to monitoring data communications performance future development of data link communications applications would be assisted if existing message use statistics were available. ANSP should maintain message use statistics.

D.1.10 This appendix contains the following guidance material:

a) ANSP data collection and analysis - This section defines a common data reporting format. Guidance material is included on how to obtain the required data points from the FANS 1/A ACARS and ATN B1 messages and on the calculation of actual communication performance (ACP), actual communication technical performance (ACTP), pilot operational response time (PORT), actual surveillance performance (ASP), and how they are calculated. Examples of the type of analysis that can be carried out at an ANSP level are also included. Issues regarding data filtering are discussed including guidance on how to manage this.

b) Problem reporting and resolution – This section provides guidance on the problem identification and resolution process

c) Regional performance monitoring – This section provides guidance on the monitoring of ADS-C actual surveillance performance and CPDLC actual communication performance at a regional level.

D.2 ANSP data collection and analysis

D.2.1 General

D.2.1.1 Data link performance requirements for the application of reduced separation standards, as defined in ICAO Doc 4444, are contained in the following documents:

a) RTCA DO-306/EUROCAE ED-122 – Oceanic SPR standard. These requirements are specified in terms of RCP and RSP.

b) RTCA DO-290/EUROCAE ED-120 – Continental SPR standard. The EUR instantiation of DO290/ED120 comprises the performance requirements for DLIC (Logon and Contact) and CPDLC (ACM, ACL).

Note.— The intention is to specify an RCP type for ACM and ACL-Controller initiated messages for the EUR region. An update of DO-290/ED-120 is expected.

D.2.1.2 ANSP that are currently monitoring data link performance have found that a monthly monitoring interval usually provides enough data points to detect any performance variation and is adequate for post implementation monitoring.

D.2.2 ANSP data collection for CPDLC application

D.2.2.1 General

D.2.2.1.1 This section provides guidance on data collection and performance measurement for the CPDLC application.

D.2.2.1.2 For procedural airspace, the measurements are taken from CPDLC ground-initiated transactions.

D.2.2.1.3 For EUR continental airspace, the following measurements are taken:

- a) DLIC-contact transactions;
- b) CPDLC ground-initiated and air-initiated transactions.

Note.— *Air-initiated and ground initiated transactions will be analysed separately since they have different performance requirements (refer to [Appendix B](#)).*

D.2.2.2 Measuring CPDLC communication performance

D.2.2.2.1 CPDLC analysis is based on the calculation of actual communication performance (ACP) used to monitor RCP time allocation for communication transaction (TRN), actual communications technical performance (ACTP) used to monitor required communication technical performance (RCTP) time allocation, and pilot operational response time (PORT) used to monitor the responder performance criteria of the transaction.

Note.— *For EUR Region, ANSPs that provide data link service to FANS I/A aircraft, monitor the performance of ATN aircraft separately from FANS I/A aircraft as the underlying technology is different.*

D.2.2.2.2 CPDLC controller-initiated transactions

D.2.2.2.2.1 The analysis uses the measurement of transit and response times to a subset of CPDLC uplinks that receive a single [DM 0](#) WILCO response. Responses not measured are where an uplink receives [DM 1](#) UNABLE, [DM 2](#) STANDBY, [DM 3](#) ROGER, [DM 4](#) AFFIRM, [DM 5](#) NEGATIVE responses. A [DM 0](#) WILCO response following a [DM 2](#) STANDBY is also not measured. The rationale behind this is that the critical communications requirement is provided by intervention messages when applying reduced separation standards. Incorporating other message types such as free text queries, information requests not requiring a [DM 0](#) WILCO response, messages with [DM 1](#) UNABLE responses, or [DM 2](#) STANDBY responses followed by [DM 0](#) WILCO, or non-intervention re-route messages [UM 79](#), [UM 80](#), and [UM 83](#) will skew the observed data because of the longer response times from the flight deck.

D.2.2.2.2.2 Typically all intervention messages with a W/U response attribute, except for non-intervention route messages ([UM 79](#), [UM 80](#), [UM 81](#), [UM 82](#), [UM 83](#), [UM 84](#), [UM 91](#), and [UM 92](#)), contact instructions ([UM 117](#) – [UM 123](#)) and [UM 116](#) “RESUME NORMAL SPEED” messages are assessed. Data analysis has shown that Pilot Operational Response Time (PORT) to these non-intervention messages can be significantly skewed and will significantly impact measured ACP. However, the removal of all contact instructions ([UM 117](#) – [UM 123](#)) will drastically reduce the monthly data set for some smaller ANSP and make it difficult to assess ACTP for individual fleets or aircraft on a monthly basis. For this reason some ANSP retain these ([UM 117](#) – [UM 123](#)) transactions when assessing ACTP. ANSP should decide on a data set that provides them with the best performance modeling for their operation.

Note.— The EUR region measures all implemented controller-initiated messages, including all received responses.

D.2.2.2.2.3 To calculate ACP, the difference between the times that the uplink message is originated at the ANSP to the time that the corresponding response downlink is received at the ANSP is used.

D.2.2.2.2.4 To calculate ACTP, the difference between the downlink's aircraft time stamp and the received time is added to half the round trip time determined by the difference between the uplink time when the message is sent from the ANSP and the receipt of the MAS response for the uplink at the ANSP ((uplink transmission time – MAS receipt)/2 + downlink time).

D.2.2.2.2.5 The EUR region measures ACTP by taking the difference between the MAS/LACK reception time and CPDLC Uplink message transmission time. The uplink messages are associated with their corresponding MAS/LACKs through the use of the CPDLC Message Reference Number (See [Figure D-2](#)).

D.2.2.2.2.6 PORT is calculated by the difference between ACP and ACTP. [Figure D-1](#) illustrates these measurements.

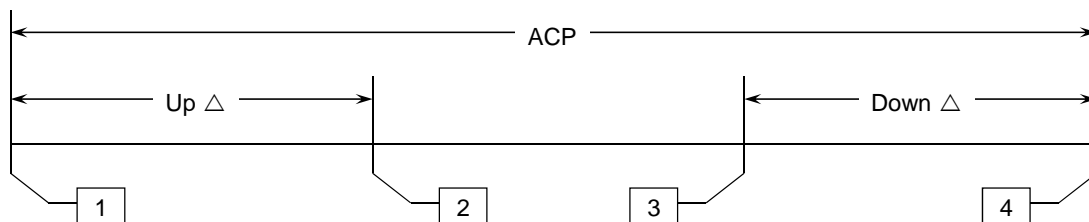

1. Uplink Sent. This is the date/time that the CPDLC clearance was sent to the aircraft.
2. MAS Received. This is the date/time that the MAS for the CPDLC clearance was received.
3. WILCO Sent. This is the date/time that the WILCO reply is transmitted.
4. WILCO Received. This is the date/time that the WILCO reply for the CPDLC clearance was received.

The measurements (in seconds) are calculated as follows:

$$\begin{aligned} \text{ACP} &= (\text{WILCO_Received}) - (\text{Uplink_Sent}) \rightarrow \text{TRN} \\ \text{ACTP} &\cong \left(\left(\frac{\text{Up}\Delta}{2} \right) + (\text{Down}\Delta) \right) \rightarrow \text{RCTP} \\ \text{PORT} &\cong \text{ACP} - \text{ACTP} \rightarrow \text{Responder} \end{aligned}$$

Figure D-1. CPDLC transaction calculations

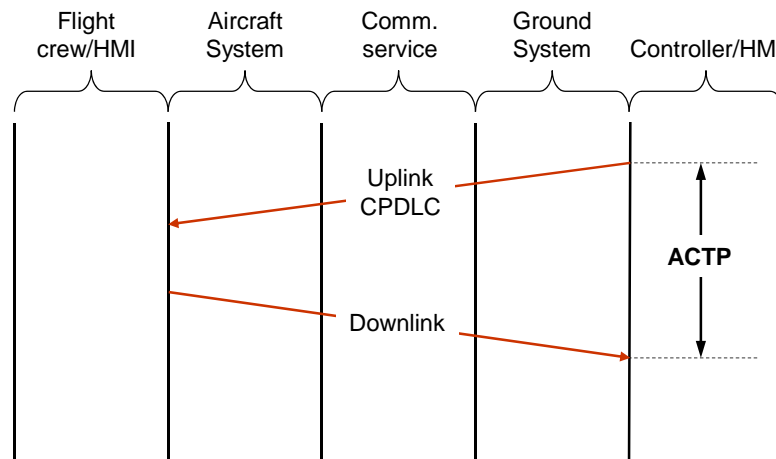

Figure D- 2. EUR Region – ACTP measurement

D.2.2.2.7 The values for ACTP and PORT are only approximations. Uplink transit times are estimated by taking half the time for the MAS/LACK response round trip. This assumption is flawed in a small percentage of cases because we know it is possible for the MAS to be received at the ANSP after the operational response is received; or for the timestamp on the operational response to be earlier than the MAS receipt time. This will happen if the CSP does not hear the network ACK from the aircraft (which is sent on uplink receipt) and resends the uplink later. The CSP receives the network ACK to this second uplink and sends the MAS to the ANSP. In the meantime, the aircraft has already responded with the operational response. ANSP will see this issue reflected in their data with crew response times with negative or extremely small values. All transactions with zero or negative crew response times should be filtered from data prior to analysis. The time sequence diagram below in Figure D- 2 illustrates the issue. Errors can also arise if there are delays between the ANSP and the CSP on the uplink path. These delays will result in excessive calculated PORT and skewed ACP.

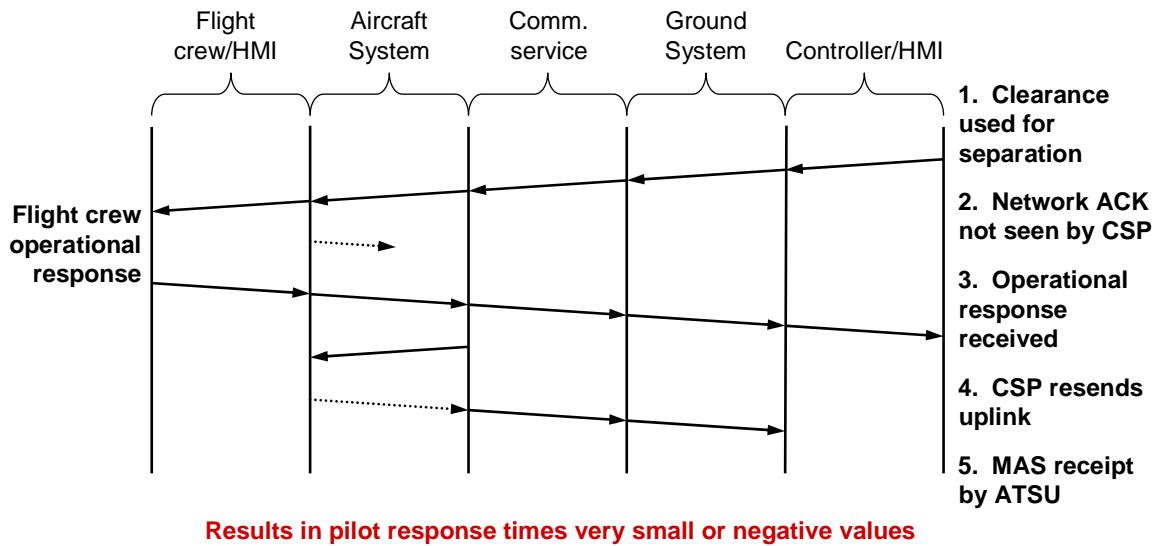

Figure D-3 Issue with estimating uplink transit time as half MAS roundtrip

D.2.2.2.3 CPDLC flight crew-initiated transactions

D.2.2.2.3.1 The EUR region measures the transit and response times to a subset of CPDLC downlinks that receive a single UNABLE or Clearance response.

D.2.2.2.3.2 To calculate ACP, the difference between the time in the header of the LACK message acknowledging the response to the time in the CPDLC header of the downlinked request message. [Figure D-4](#) illustrates the measurements.

Note.— The time provided in the header of the LACK message, sent from the aircraft, can be considered as giving a fairly accurate indication of when the associated uplink response has been processed and is available to the flight crew.

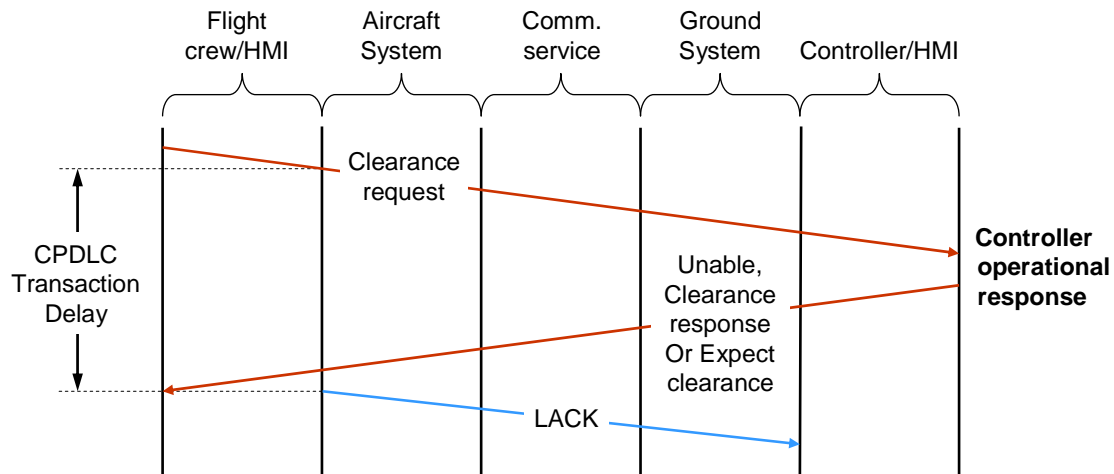

Figure D- 4 Flight crew-initiated ACP delay

D.2.2.2.4 DLIC contact transactions

D.2.2.2.4.1 The EUR region measures the DLIC-Contact transaction delay. The ACP is calculated by the difference between the Contact response reception time and the Contact request transmission time as is illustrated in [Figure D- 4](#).

Note.— It is not possible to accurately measure DLIC-Logon transactions. Moreover, a logon is normally initiated well in advance of establishing a CPDLC connection with the first ATSU.

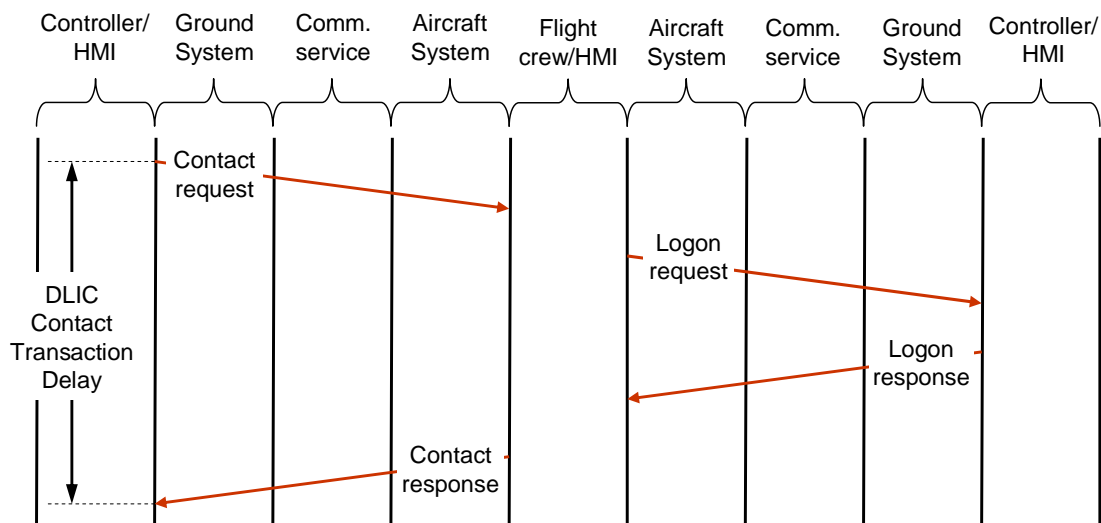

Figure D- 5 DLIC Contact transaction

D.2.2.3 Recording the data points for each CPDLC transaction

D.2.2.3.1 The following data points in [Table D-1](#) are recommended as the minimum set that should be extracted from ANSP data link system recordings to enable RCP analysis and provide sufficient information for problem analysis. This does not preclude individual ANSP from extracting additional data points for their own analysis requirements and some possibilities are listed below. To obtain these data points ANSP should note that they will require additional database information to enable the aircraft type and operator to be obtained by correlation to the aircraft registration extracted from the data link recordings. All of the other data points are extracted from either the ACARS or ATN B1 header or the CPDLC application message.

Table D-1 CPDLC data collection points

Ref	Label	Description and/or remarks
1	ANSP	The four letter ICAO designator of the facility (e.g. NZZO).
2	Aircraft registration (FANS 1/A)	The aircraft registration in ICAO Doc 4444 Format (no hyphens, packing dots, etc.) (e.g. N104UA). <i>Note.— Extracted from ACARS header or application message.</i>
2	Aircraft address (ATNB1)	The 24 bit address in ICAO Doc4444 Format (alphanumerical character, in six hexadecimal). <i>Note.— Extracted from CM application message.</i>
3	Aircraft type designator	The ICAO aircraft type designator (e.g. B744). <i>Note.— Extracted from ANSP database using aircraft registration as key.</i>
4	Operator designator	The ICAO designator for the aircraft operating agency (e.g. UAL). <i>Note.— Extracted from ANSP database using aircraft registration as key.</i>
5	Date	In YYYYMMDD format (e.g. 20081114). <i>Note.— Extracted from ANSP system data recording time stamp, synchronized to within 1 second of Universal Time Coordinated (UTC).</i>
6	MAS RGS	Designator of the RGS that MAS downlink was received from (e.g. POR1). <i>Note.— This is a 3 or 4 letter designator extracted from the ACARS header DT line.</i>
7	OPS RGS	Designator of the RGS that the operational response was received from (e.g. AKL1). <i>Note.— This is a 3 or 4 letter designator extracted from the ACARS header DT line.</i>
8	Uplink time	The timestamp on the uplink CPDLC message sent by the ANSP in HH:MM:SS format (e.g. 03:43:25). <i>Note.— Extracted from ANSP system data recording time stamp, synchronized to within 1 second of UTC.</i>
9	MAS/LACK receipt time	The ANSP timestamp on receipt of the MAS/LACK in HH:MM:SS format (e.g. 03:43:35). <i>Note.— Extracted from ANSP system data recording time stamp, synchronized to within 1 second of UTC.</i>

Ref	Label	Description and/or remarks
10	MAS/LACK round trip time	In seconds (#9-#8) (e.g. 10).
11	Aircraft FMS time stamp	In the operational response messages in HH:MM:SS (e.g. 03:44:15). <i>Note.</i> — For FANS 1/A, extracted from the ATCmessageHeader timestamp in the decoded operational response message. See RTCA DO-258AEUROCAE ED-100A section 4.6.3.3.
12	ANSP timestamp on the receipt of the operational response	In HH:MM:SS (e.g. 03:44:45). <i>Note.</i> — Extracted from ANSP system data recording time stamp, synchronized to within 1 second of UTC.
13	Operational message round trip time	From sending uplink (#8) to receipt of operational response (#12) in seconds (e.g. 80).
14	Downlink response transit time	In seconds (#12-#11) (e.g. 30).
15	Uplink message elements	All uplink message element identifier preceded by U encapsulated between quotation marks with a space between each element (e.g. “U118 U80”) <i>Note.</i> — Extracted from the decoded operational uplink that initiated the transaction.
16	Downlink message elements	All downlink message elements encapsulated between quotation marks with a space between each element if required (e.g. “D0”) <i>Note.</i> — Extracted from the decoded operational downlink.
17	ACTP	Actual communication technical performance in seconds (e.g. 35). <i>Note.</i> — Truncated to whole seconds.
18	ACP	Actual communications performance in seconds measured as the difference between time uplink sent (#8) to operational response received (#12) (e.g. 80).
19	PORT	Pilot Operational Response Time = ACP (#18) - ACTP(#17) (e.g. 45). <i>Note.</i> — Implementers should allow for negative values where the operational response is received before the MAS as per Figure D- 3 above. When graphing PORT negative values should be counted as 0.

D.2.2.3.2 ANSP may find that the following additional data may be useful for performance analysis:

- a) The aircraft call sign extracted from either the Flight Plan (e.g. ANZ123) or the logon request message for the flight (e.g. NZ123) or the FI line in the ACARS header (e.g. NZ0123);
- b) Direction of flight calculated by the flight data processor and displayed as a three figure group representing degrees true (e.g. 275); and
- c) The estimated position in latitude and longitude of the aircraft when a CPDLC downlink is sent. Calculated by the flight data processor. For consistency the following formats are recommended: For

latitude use “+” for North or “-” for South followed by a decimal number of degrees (e.g. -33.456732). For longitude use “+” for East or “-” for West followed by a decimal number of degrees (e.g. +173.276554).

d) The data link communications type (COMTYP). Extracted from the MAS RGS and OPS RGS identifying the media used for the uplink and downlink message. There are nine possible entries for COMTYP: SAT, VHF, HF, SV, SH, VS, VH, HS, HV. Value is based on the MAS RGS field (#6) and OPS RGS (#7) and are listed in [Table D-2](#).

e) The regional CRA should consider promulgating a list of RGS designators that are applicable to their region.

Table D-2. Determination of COMTYP indicators

MAS RGS Communication Type	OPS RGS Communication Type	COMTYP
SAT (e.g. MAS RGS = POR1)	SAT (e.g. OPS RGS = POR1)	SAT
VHF (e.g. MAS RGS = ADK)	VHF (e.g. OPS RGS = ADK)	VHF
HF (e.g. MAS RGS = H02)	HF (e.g. OPS RGS = H02)	HF
SAT (e.g. MAS RGS = POR1)	VHF (e.g. OPS RGS = ADK)	SV
SAT (e.g. MAS RGS = POR1)	HF (e.g. OPS RGS = H02)	SH
VHF (e.g. MAS RGS = ADK)	SAT (e.g. OPS RGS = POR1)	VS
VHF (e.g. MAS RGS = ADK)	HF (e.g. OPS RGS = H02)	VH
HF (e.g. MAS RGS = H02)	VHF (e.g. OPS RGS = ADK)	HV
HF (e.g. MAS RGS = H02)	SAT (e.g. OPS RGS = POR1)	HS

D.2.2.3.3 For ATN B1 and FANS 1/A service provision in EUR Region, the following additional data should be provided:

a) **DLIC Initiation Logon Counts**. The number of unsuccessful logon attempts, the number of successful logon attempts followed by the establishment of a CPDLC connection, and the number of successful logon attempts that are not followed by the establishment of a CPDLC connection.

b) **Continuity for DLIC-Contact and CPDLC ground-initiated and air-initiated transactions**. As the performance requirements are different for ground-initiated transactions and air-initiated transactions, the actual probability for Continuity is calculated separately for ground-initiated and air-initiated transactions

c) **Availability (Use)**. The number of Provider Aborts experienced by the ANSP and manually reported availability problems affecting a single aircraft.

Note.— Measuring actual probability of A(USE) according to formal definition is problematic. An acceptable indication is by counting the number of provider aborts (The Air-Ground connectivity is lost after 6 minutes)

d) **Availability(Provision)**. Defined as Actual hours of CPDLC Operations / Planned Hours of CPDLC Operations, where:

1) **Actual hours** of CPDLC Operations = Planned Hours of CPDLC Operations - Accumulated declared unplanned service outages.

2) **Planned Hours of CPDLC Operations** = 24x7 operations over a certain period – planned service outages

3) **Accumulated declared unplanned service outages** = sum of all partial failures (affecting multiple aircraft) or total failure (affecting all aircraft) over a certain period.

4) **Unplanned service outages** affecting more than one aircraft are due to problems, originated from, for example, FDP, ACSP, VDL GS, router.

e) **Deployment indicators** using:

1) **Fleet Equipage**. The percentage of the aircraft fleet equipped to use CPDLC.

2) **Fleet Usage**. The percentage of the aircraft fleet equipped to use CPDLC that are actually using CPDLC operationally.

f) **System health indicators**, using:

1) **User Aborts**. The number of user aborts.

2) **Error messages**. The number of different types of error message.

3) **Message Usage**. The number of different ACL and ACM messages sent.

4) **Transport level (TP4) retries (ATN B1)**. The number of uplink retries per ground end-system identifying which aircraft were involved, along with the ratio of the number of uplink TP4 retransmissions to the number of successfully transmitted Data TPDU's per ground end- system. Monitoring the rate of TP4 retries for each system on the ground and identifying which aircraft are involved will allow the identification of problems occurring within the network/ground system or with a particular aircraft.

Note.— A TP4 retry could occur as the result of i) temporary delays , ii) unavailability of a component of the network, iii) a dysfunctional VDL handoff or iv) a problem in an end- system (ATSU or avionics).

5) **Failed transport connection attempts (ATN B1)**. The number of failed transport connection attempts measured per ground end-system identifying which aircraft were involved. Monitoring the number of failed attempts to establish a transport level connection will give an indication of problems with the slightly longer term availability of one of the end-systems or the underlying network.

6) **TP4 Round Trip Delay (ATN B1)**. The time taken from the transmission of a Data TPDU to its acknowledgement.

g) **Inconsistency in flight plan and log on association**. The number of inconsistencies found in flight plan - logon association criteria (i.e. aircraft registration/aircraft address, data link equipment and capability in item 10a).

ANSP may find that the following additional data may be useful for performance analysis:

h) **Air-ground VDLM2 data**. CSP sends VDLM2 data to the CRO, which may be supplemented with VDLM2 data from ANSPs for VDLM2 frequency capacity planning and problem investigation.

D.2.2.4 Data record for each CPDLC transaction

D.2.2.4.1 If required for regional monitoring agency analysis CPDLC transaction data as described above may be sent to the regional/State monitoring agency at as a comma delimited text file. The format for each record will at minimum contain the 20 data points specified in [Table D-1](#). Using the example in the previous paragraph the data record for the transaction described above in comma delimited format is:

NZZO,N104UA,B744,UAL,20081114,POR1,AKL1,03:43:25,03:43:35,10,03:44:15,03:44:45,80,30,"U118 U80","D0",35,80,45

D.2.2.4.2 Guidance on the type of analysis carried out at an ANSP or regional level is provided later in [paragraphs D.2.4 and D.3.1](#).

D.2.2.4.3 Because different ANSPs may use different data sets for analysis within their area of interest the data sent to a regional state monitoring agency should at minimum contain all transactions that contain a WILCO response. The regional monitoring agency will filter transactions as agreed by their regional forum.

D.2.3 ANSP data collection for ADS-C application

D.2.3.1 General

D.2.3.1.1 This section provides guidance on data collection and performance measurement for the ADS-C application.

D.2.3.2 Measuring actual surveillance performance (ASP)

D.2.3.2.1 The analysis of actual communication performance (ASP) is based on the measurement of the transit times of the ADS-C periodic and event reports between the aircraft and the ANSP ground system. This is measured as the difference between the time extracted from the decoded ADS-C basic group timestamp when the message originated from the FMS and the time the message is received at the ANSP.

D.2.3.3 Recording the ADS-C data points for each ADS-C downlink

D.2.3.3.1 The following data points in [Table D-3](#) are recommended as the minimum set that should be extracted from ANSP data link system recordings to enable an analysis of ADS-C performance and provide sufficient information for problem analysis. This does not preclude individual ANSP from extracting additional data points for their own analysis and some possibilities are listed below. To obtain all of these data points ANSP should note that they will require additional database information to enable the Aircraft Type and Airline to be obtained by correlation to the aircraft registration extracted from the data link recordings. All of the other data points are extracted from either the ACARS header or the ADS-C application message.

Table D-3 ADS-C data collection points

Ref	Label	Description and/or remarks
1	ANSP	The four letter ICAO designator for the facility (e.g. NZZO).

Ref	Label	Description and/or remarks
2	Aircraft Registration	The aircraft registration in ICAO Doc 4444 Format (no hyphens, packing dots, etc.) (e.g. N104UA). <i>Note.</i> — <i>Extracted from ACARS header or application message.</i>
3	Aircraft Type Designator	The ICAO aircraft type designator (e.g. B744). <i>Note.</i> — <i>Extracted from ANSP database using aircraft registration as key.</i>
4	Operator Designator	The IATA designator for the aircraft operating agency (e.g. UAL). <i>Note.</i> — <i>Extracted from ANSP database using aircraft registration as key.</i>
5	Date	In YYYYMMDD format (e.g. 20081114). <i>Note.</i> — <i>Extracted from ANSP system data recording time stamp, synchronized to within 1 second of UTC.</i>
6	RGS	Designator of the RGS that ADS-C downlink was received from (e.g. POR1). <i>Note.</i> — <i>This is a 3 or 4 letter designator extracted from the ACARS header DT line.</i>
7	Report Type	The type of ADS-C report extracted from the ADS-C basic group report tag where tag value 7=PER, 9=EMG, 10=LDE, 18=VRE, 19=ARE, 20=WCE. As some aircraft concatenate more than one report in the same downlink extract the ADS-C report tag from each ADS-C basic group and identify them in the REP_TYPE column by using the first letter of the report type as an identifier (e.g. for a concatenated report containing two ADS-C basic groups for a periodic report and a waypoint event report the field will contain PW). Where a downlink does not contain an ADS-C basic group, the REP_TYPE field will be left blank.
8	Latitude	The current latitude decoded from the ADS-C basic group. The format is “+” for North or “-“ for South followed by a decimal number of degrees (e.g. -33.456732).
9	Longitude	The current longitude decoded from the ADS-C basic group. The format is “+” for East or “-“ for West followed by a decimal number of degrees (e.g. +173.276554).
10	Aircraft Time	The time the ADS-C message was sent from the aircraft in HH:MM:SS (e.g. 03:44:15). <i>Note.</i> — <i>Decoded from the ADS-C basic group timestamp extracted as seconds since the most recent hour. See RTCA DO-258A/EUROCAE ED-100A, section 4.5.1.4.</i>
11	Received Time	The ANSP timestamp on the receipt of the ADS-C message in HH:MM:SS (e.g. 03:44:45). <i>Note.</i> — <i>Extracted from ANSP system data recording time stamp, synchronized to within 1 second of UTC.</i>
12	Transit Time	The transit time of the ADS-C downlink in seconds calculated as the difference between #10 Aircraft Time and #11 Received Time (e.g. 30).

D.2.3.3.2 ANSP may find that the following additional data may be useful for performance analysis:

- a) The aircraft call sign extracted from either the Flight Plan (e.g. ANZ123), the AFN logon for the flight (e.g. NZ123) or the FI line in the ACARS header (e.g. NZ0123).
- b) Direction of flight calculated by the ANSP flight data processor and displayed as a three figure group representing degrees true (e.g. 275).
- c) The current altitude (e.g. 35,000) decoded from the ADS-C basic group. The altitude combined with the latitude, longitude, and time provide the aircraft position at the time the report was generated. Aircraft movement data is needed in airspace safety assessments and/or airspace safety monitoring analyses. Inclusion of altitude in the GOLD data sample would allow for GOLD data to be used for both data link performance monitoring and airspace safety monitoring analyses,
- d) ADS-C predicted position latitude and longitude and time when available. (Note.— time decoded from the ADS-C predicted group where timestamp is extracted as seconds since the most recent hour. (See RTCA DO-258A section 4.5.1.4)) For consistency the following formats are recommended: For latitude use “+” for North or “-” for South followed by a decimal number of degrees (e.g. -33.456732). For longitude use “+” for East or “-” for West followed by a decimal number of degrees (e.g. +173.276554).
- e) The data link communications type (COMTYP) based on the RGS field (#6). Satellite (SAT), Very High Frequency (VHF), High Frequency (HF). Refer to [Table D-2](#).

D.2.3.4 Data record for each ADS-C downlink

D.2.3.4.1 If required for regional/State monitoring agency analysis ADS-C transaction data as described above may be sent to the regional regional/State monitoring agency as a comma delimited text file. The format for each record will at minimum contain the 12 data points specified in [Table D-2](#). Using the example in the previous paragraph the data record for the transaction described above in comma delimited format is:

NZZO,N104UA,B744,UAL,20081114,POR1,PER,-33.456732,+173.276554,03:44:15,03:44:45,30

D.2.3.4.2 Guidance on the type of analysis carried out at an ANSP or regional level is provided later in [paragraphs D.2.4 and D.3.1](#).

D.2.4 ANSP data analysis

D.2.4.1 General

D.2.4.1.1 To enable adequate system performance monitoring ANSP should at minimum perform a monthly analysis of CPDLC RCP and ADS-C performance data. This monitoring will verify system performance and also enable continuous performance improvement by detecting where specific aircraft or fleets are not meeting the performance standards.

D.2.4.1.2 While this analysis could be carried out by a regional monitoring agency, it is thought the analysis will be more efficient if done by the ANSP. It is the ANSP that will usually have the operational expertise and local area knowledge that is important when identifying problems from any data analysis.

At least one region has had considerable success by using some of the regional ANSP to complete a monthly data analysis and reporting the identified problems to the regional monitoring agency for resolution.

D.2.4.1.3 A regional monitoring agency is best suited to manage problems reported from the ANSP analysis, and to develop actual regional performance figures from information supplied by the ANSP. Analysis by the individual ANSP will also avoid the regional monitoring agency having to manage a large quantum of data that the ANSP already holds.

D.2.4.2 Graphical analysis

D.2.4.2.1 It is recommended that ANSP perform a graphical analysis of the performance data gathered. This graphical analysis is useful for depicting in a readily assimilated fashion actual performance, and has proved extremely useful when identifying performance problems.

D.2.4.2.2 Monitoring can be completed at a number of levels and similar levels can be used for both CPDLC and ADS-C performance monitoring. The following structure is recommended:

- a) Monitoring Communication Media Performance. An analysis of:
 - 1) Data from all aircraft via all Remote Ground Station (RGS) types.
 - 2) Data from all aircraft via SATCOM RGS
 - 3) Data from all aircraft via VHF RGS
 - 4) Data from all aircraft via HF RGS
 - 5) Data from all aircraft via HF and SATCOM RGS

Note.— The monitoring of combined HF and SATCOM data is to allow verification that the performance obtained from those aircraft using HFDL for downlinks only when SATCOM is not available does not degrade performance by an unacceptable level.

- b) Monitoring Airline Fleet Performance. An analysis of:
 - 1) The observed performance of each type of aircraft operated by an operator:
 - i) Via SATCOM
 - ii) Via SATCOM + HF
 - iii) Via HF
 - iv) Via VHF
 - v) Via All RGS
 - 2) Comparative analysis of the observed performance from the same type of aircraft from different operators.

Note.— When measuring CPDLC performance for a specific media type(s) then only those transactions where both the RGS for the MAS and the RGS of the operational response are from that media type would be measured. Mixed media transactions such as where the MAS is received via a VHF RGS and the operational response is via a SATCOM RGS would be excluded from a SATCOM analysis. Mixed media transactions would be counted in the SATCOM + HF, and All RGS analysis above.

D.2.4.3 Data filtering

D.2.4.3.1 It is important that consistent data filtering is employed to ensure that all ANSP measure against the same baseline. Raw data obtained from the ANSP recordings will include delayed transactions measured during periods of system outage and these should not be used when assessing CPDLC transaction time or surveillance data transit time. The data may also include duplicated messages which will also skew the measurements if not removed. This data should be filtered from the raw data before any performance assessment is made.

D.2.4.3.2 System Outages

D.2.4.3.2.1 In accordance with the provisions of [paragraph 3.1.3](#), the ANSP should ensure that the service level agreement with their CSP includes a requirement for the reporting of all system outages that will affect the delivery of traffic to and from the ANSP. CSP reporting should include for each outage:

- a) Type of outage and the media affected;
- b) Outage start time;
- c) Outage end time; and
- d) Duration of Outage.

D.2.4.3.2.2 The raw data should be checked for any delayed transactions observed during system outages. These delays are easily identified during outages that have been notified by the CSP, but the data should be carefully reviewed for outages that have not been notified. Delays observed from multiple aircraft where the downlinks completing the transactions are received at similar times indicate a system outage. CPDLC transactions and surveillance data delivery measurements during these outage periods should be removed. A typical outage not notified by any DSP is illustrated in [Table D- 4](#) showing ADS-C downlink delays from 3 aircraft between 1120 and 1213.

Table D- 4. ADS-C outages not notified

Aircraft registration	Aircraft time	ANSP system time	Downlink time (Seconds)
ZK-SUI	11:55:38	12:12:52	1034
ZK-SUI	11:44:42	12:12:19	1657
ZK-SUJ	11:41:54	12:12:01	1807
ZK-SUJ	11:26:18	12:09:42	2604
ZK-SUI	11:23:21	12:08:32	2711
ZK-SUJ	11:20:34	12:07:39	2825
ZK-OKG	11:53:52	12:12:51	1139

D.2.4.3.3 Duplicated ADS-C reports

D.2.4.3.3.1 Numerous instances of duplicate ADS-C reports are observed in FANS-1/A data records. A particular report is often duplicated with the second and sometimes third record duplicated at

some later time as illustrated in [Table D- 5](#). These duplicate records will skew ADS-C surveillance data delivery measurements and should be removed.

Table D- 5. ADS-C duplicate reports

LAT_LON	Aircraft time	ANSP system time	Downlink time (Seconds)
350225S1694139E	22:29:45	22:31:04	79
350225S1694139E	22:29:45	22:34:56	311
350225S1694139E	22:29:45	22:40:05	620

D.2.4.4 CPDLC performance analysis

D.2.4.4.1 Monitoring of CPDLC performance involves an assessment of ACP, ACTP, and PORT by a graphical analysis of data using the structure outline in [paragraph D.2.4.2](#).

D.2.4.4.2 Monitoring communications media performance

D.2.4.4.2.1 Graphs illustrating ACP and ACTP are used to assess CPDLC transaction performance through the various communications media. Since PORT is independent of media this would normally only be assessed over one media. The graphs depict measured performance against the TRN and RCTP requirements at the 95% and 99.9% level and would be completed for the performance specifications in use (e.g. RCP 240, RCP 400). An analysis is completed for:

- a) Data from all aircraft via all remote ground station (RGS) types.
- b) Data from all aircraft via SATCOM RGS
- c) Data from all aircraft via VHF RGS
- d) Data from all aircraft via HF RGS
- e) Data from all aircraft via HF and SATCOM RGS

D.2.4.4.2.2 A typical graph illustrating SATCOM ACTP performance constructed using a spreadsheet application is illustrated in [Figure D- 6](#). Similar graphs are used to assess ACTP and ACP for other communications media.

D.2.4.4.2.3 [Figure D- 6](#) graphs ACTP against the 95% 120” and 99.9% 150” requirements of the RCP240 specification for the years 2009-2012 as observed in the NZZO FIR.

D.2.4.4.2.4 [Figure D- 7](#) and [Figure D- 8](#) illustrate other methods of reporting performance.

D.2.4.4.2.5 Data transactions used for the measurement of SATCOM, VHF, and HF ACTP and ACP are where both the MAS and operational response are received via the media being assessed. The exception to this is the assessment of combined HF and SATCOM performance where any transaction involving HF or SATCOM is used.

D.2.4.4.2.6 Similar graphs are used to assess ACTP and ACP for other communications media.

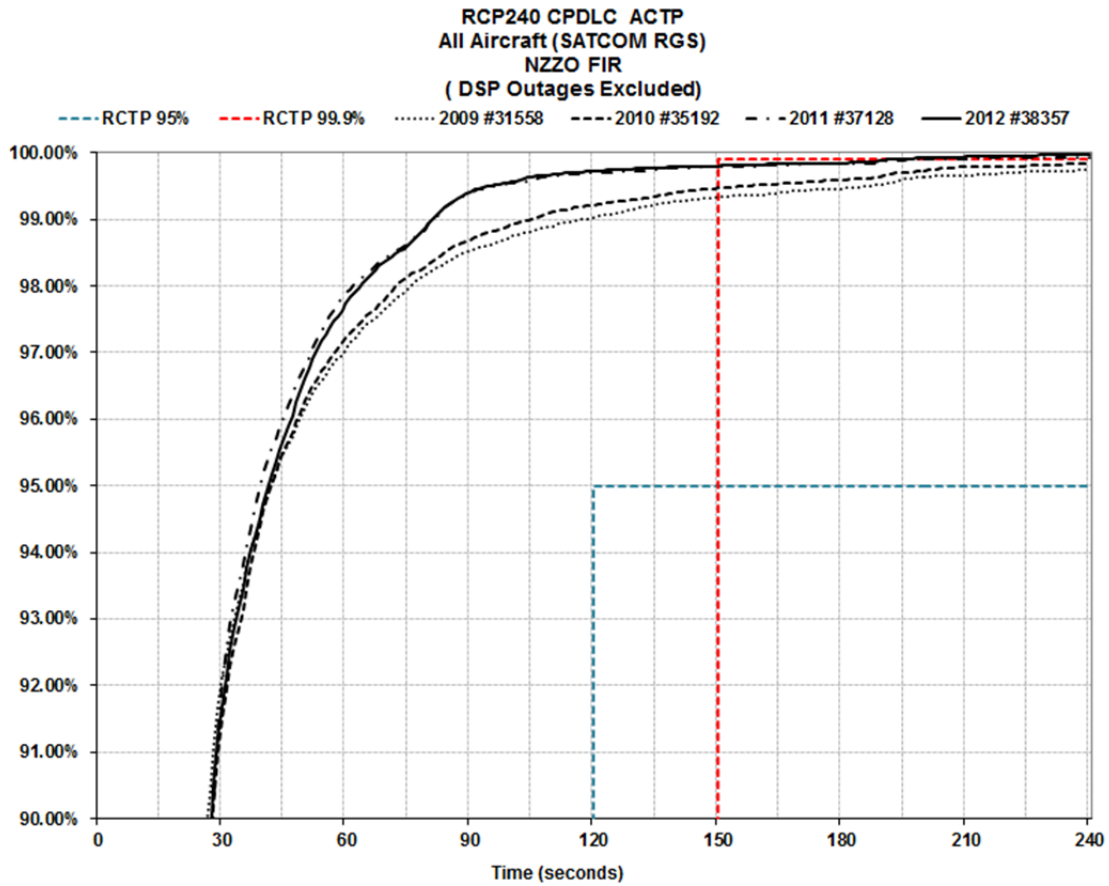

Figure D- 6. CPDLC ACTP performance - Example 1 graphical by year

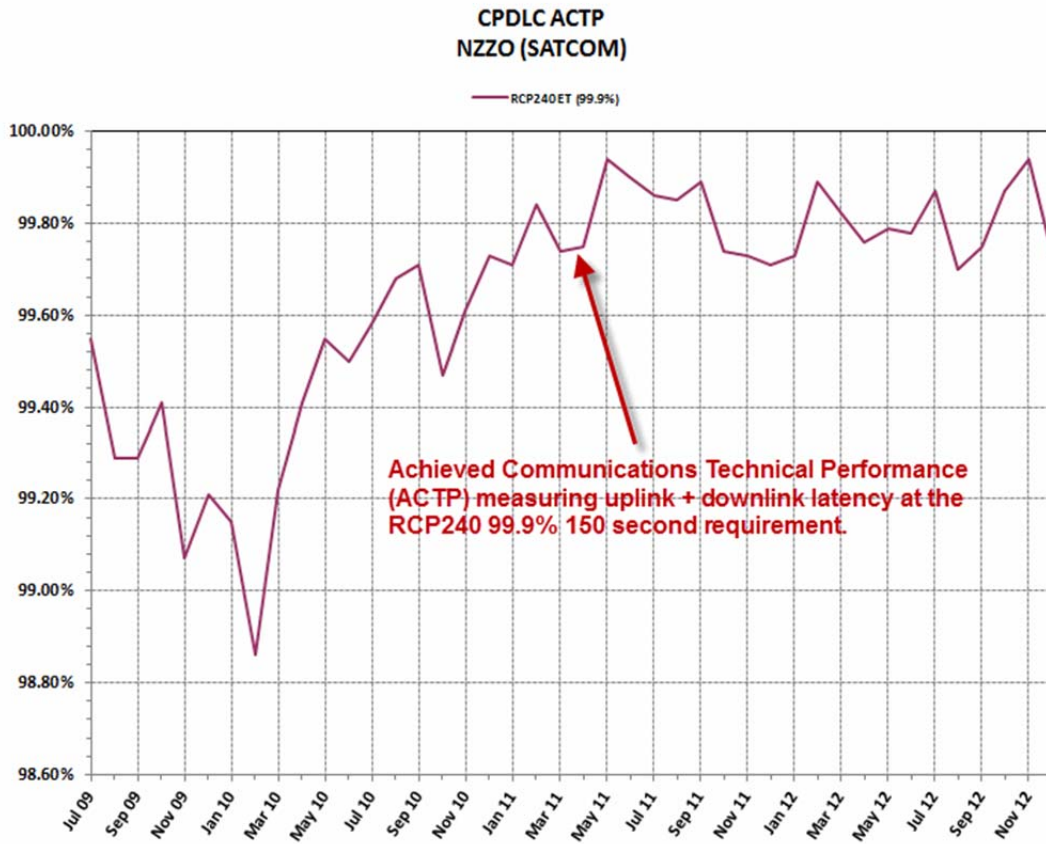

Figure D- 7 CPDLC ACTP performance – Example 2 graphical Analysis by Month

Operator	Type	# Messages	% of Total	RCTP 95% 120sec	RCTP 99.9% 150 sec
DDD	B772	457	13.08%	100.00%	100.00%
OOO	B77W	414	11.85%	100.00%	100.00%
XXX	B744	392	11.22%	100.00%	100.00%
GGG	B744	218	6.24%	100.00%	100.00%
VVV	B772	118	3.38%	100.00%	100.00%
SSS	A388	104	2.98%	100.00%	100.00%
AAA	A343	85	2.43%	100.00%	100.00%
YYY	B77W	76	2.18%	100.00%	100.00%
UUU	A388	67	1.92%	100.00%	100.00%
RRR	B772	63	1.80%	100.00%	100.00%
MIL	VARIOUS	60	1.72%	100.00%	100.00%
FFF	B772	59	1.69%	100.00%	100.00%
A2F	A332	50	1.43%	100.00%	100.00%
KKK	B744	43	1.23%	100.00%	100.00%
JJJ	A332	37	1.06%	100.00%	100.00%
A2E	A333	36	1.03%	100.00%	100.00%
TTT	A333	34	0.97%	100.00%	100.00%
HHH	B744	31	0.89%	100.00%	100.00%
A2C	B744	92	2.63%	98.91%	100.00%
OTHER	VARIOUS	31	0.89%	93.55%	100.00%
MMM	A332	258	7.38%	98.84%	99.61%
ZZZ	A343	219	6.27%	99.54%	99.54%
QQQ	B77W	155	4.44%	99.35%	99.35%
PPP	B77W	220	6.30%	98.18%	98.64%
NNN	B744	114	3.26%	97.37%	97.37%
A2D	A332	61	1.75%	91.80%	93.44%

Figure D- 8 CPDLC ACTP performance – Example 3 tabular analysis for a month

D.2.4.4.3 Monitoring airline fleet performance

D.2.4.4.3.1 Graphs illustrating ACP, ACTP, and PORT can be used to monitor the performance of each aircraft type in an operator's fleet. These should be maintained on a monthly basis and can be used to observe the performance of each type when using different media such as: via SATCOM; via SATCOM + HF; via HF; via VHF; and via all RGS. A SATCOM ACP analysis between 2009-2012 for a B744 fleet operating in the NZZO FIR is illustrated in [Figure D- 10](#).

D.2.4.4.3.2 [Figure D- 10](#) graphs CPDLC ACP against the 95% 180" and 99.9% 210" requirements for RCP240 annual aggregates for the years 2009-2012. Performance variations may be observed from month to month and these variations can be monitored over a number of months to detect any significant performance degradation that should be investigated further. Typical monthly variations are depicted in Figure D- 10. Performance variations in any month may be the result of poor performance from an individual aircraft or may simply be the result of routes changing month to month with varying weather patterns. Any significant degradation may be investigated further using an analysis of individual tails in a fleet as discussed in [paragraph D.2.4.6](#).

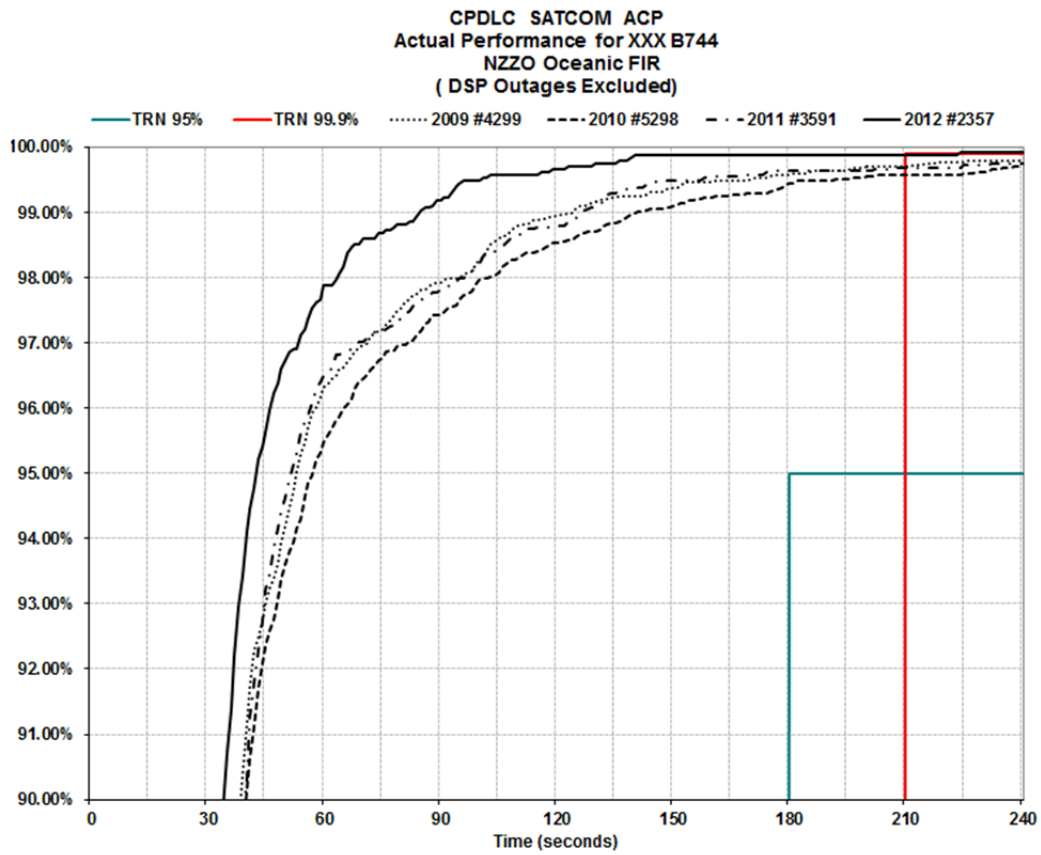

Figure D- 9 CPDLC ACP Airline XXX B744 2009-2012

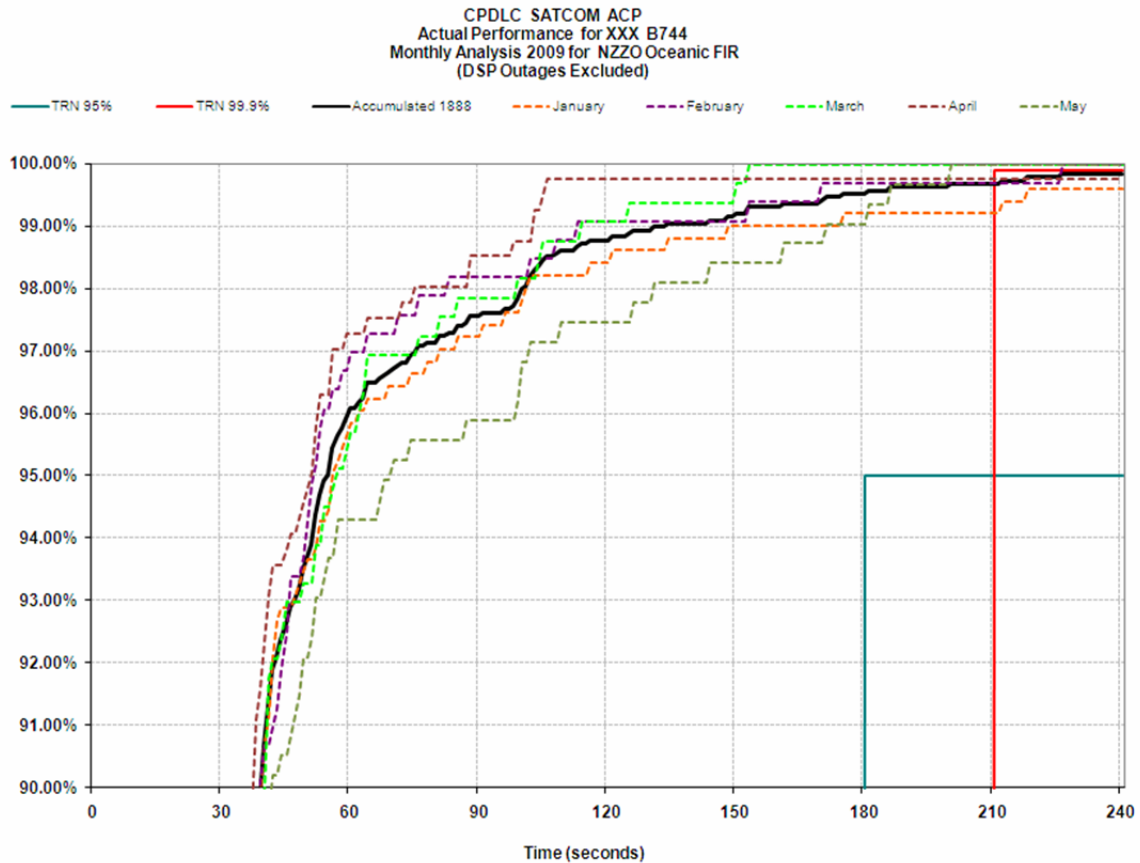

Figure D- 10. Typical monthly variation in CPDLC ACP

D.2.4.4.3.3 A comparative analysis of the performance of different fleets operating in an ATSU's airspace particularly of fleets of the same type is useful. Under performing fleets can be identified for further analysis and a picture of typical performance from all fleets can be built up. These can be compared with the same fleets operating in other ATSUs' airspace.

D.2.4.4.3.4 [Figure D- 11](#) graphs SATCOM ACTP for a number of fleets operating in NZZO FIR during 2012. Significant variations in observed performance should be flagged for further analysis as discussed in [paragraph D.2.4.6](#).

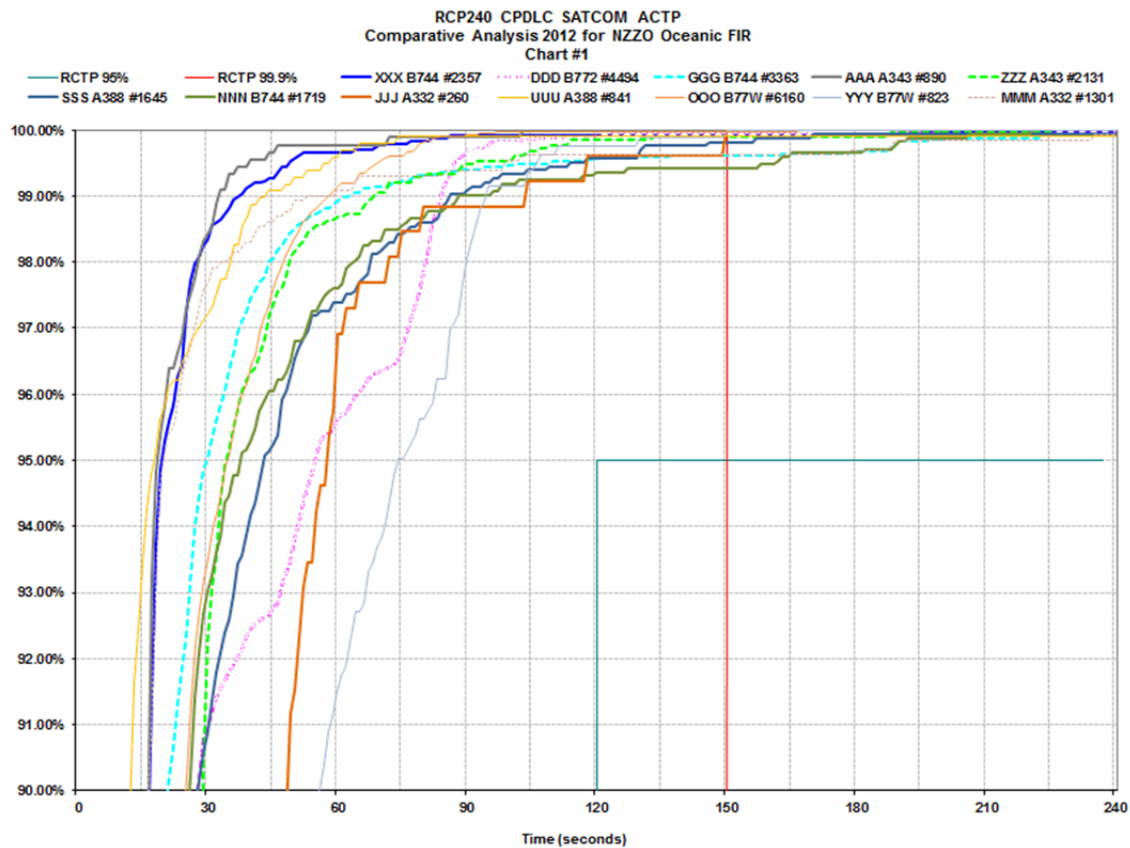

Figure D- 11. CPDLC ACTP comparative operator type performance

D.2.4.5 ADS-C surveillance data transit time analysis

D.2.4.5.1 Monitoring of ADS-C surveillance data transit time involves an assessment of observed delay from a graphical analysis of data using the structure outlined in [paragraph D.2.4.2](#).

D.2.4.5.2 Monitoring communications media performance

D.2.4.5.2.1 Graphs illustrating ADS-C surveillance data transit time are used to assess performance through the various communications media. The graphs depict measured performance against the surveillance requirements at the 95% and 99.9% level. An analysis is completed for:

- a) Data from all aircraft via all remote ground station (RGS) types.
- b) Data from all aircraft via SATCOM RGS
- c) Data from all aircraft via VHF RGS
- d) Data from all aircraft via HF RGS
- e) Data from all aircraft via combined HF and SATCOM RGS

D.2.4.5.2.2 A typical graph illustrating ADS-C surveillance data transit time observed from SATCOM and constructed using a spreadsheet application is illustrated in [Figure D- 12](#). Similar graphs are used to assess delay through individual communications media.

D.2.4.5.2.3 [Figure D- 12](#) graphs ADS-C surveillance data transit time against the 95% 90-second and 99.9% 180-second requirements for the RSP specification provided in [Appendix C, paragraph C.3](#) using the ADS-C transactions recorded during the period 2009 -2012 in the NZZO FIR.

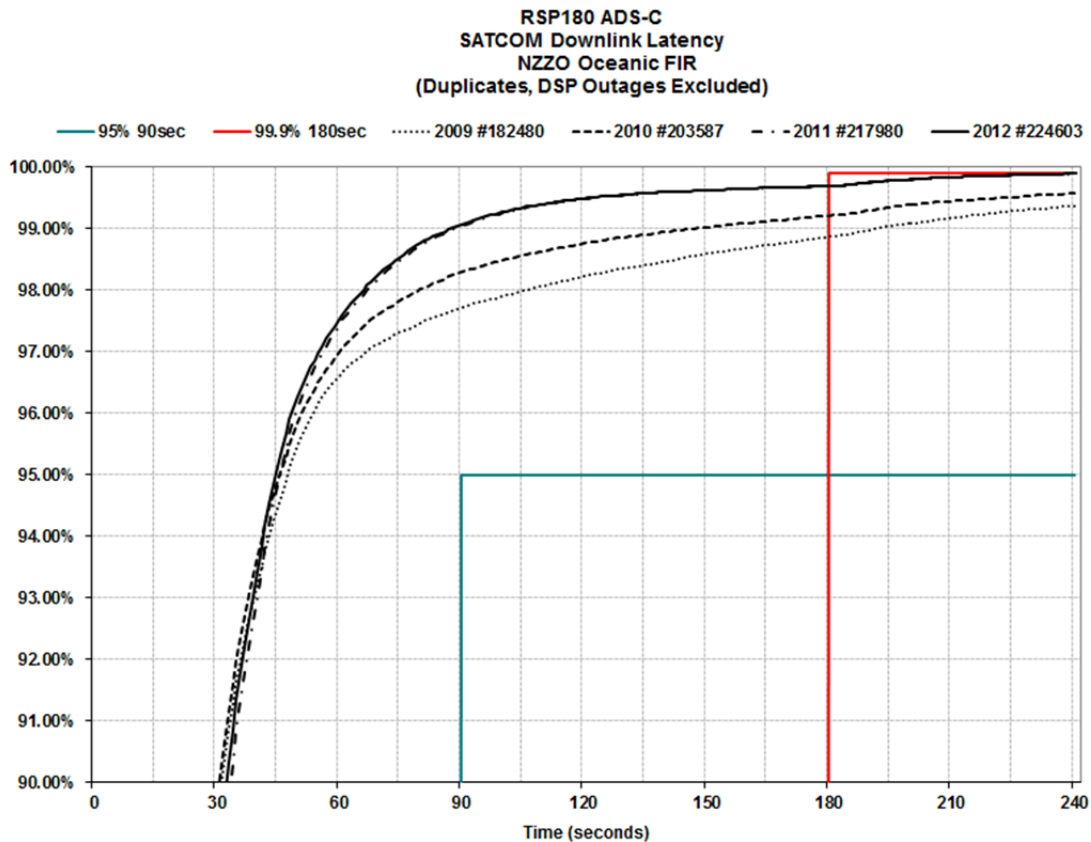

Figure D- 12. ADS-C via SATCOM NZZO FIR 2009 – 2012

D.2.4.5.3 Monitoring operator fleet performance

D.2.4.5.3.1 Graphs illustrating ADS-C surveillance data transit time can be used to monitor the performance of each aircraft type in an operator's fleet. These should be maintained on a monthly basis and can be used to observe the performance of each type when using different media such as: via SATCOM; via SATCOM + HF; via HF; via VHF; and via all RGS. The January to May 2009 SATCOM delay analysis of the A343 fleet for an operator in the NZZO FIR is illustrated in [Figure D- 13](#).

D.2.4.5.3.2 [Figure D- 13](#) graphs ADS-C surveillance data transit time against the 95% 90-second and 99.9% 180-second requirements for RSP 180D using the 3195 ADS-C downlinks recorded for the fleet during the period January-May 2009. Considerable performance variation may be seen month to month on some fleets and significant degradation in any month may be the result of poor performance

from an individual aircraft or may be the result of routes changing month to month with varying weather patterns. These may be investigated further using an analysis of individual tails in a fleet as discussed in D1.3.5 below. The fleet illustrated shows little variation between the months and for clarity only the high and low months are depicted. Over a number of years a representative picture of the expected performance for a fleet will emerge. This assists in detecting any performance degradation. [Figure D- 14](#) illustrates observed yearly performance for the same fleet from 2009-2012.

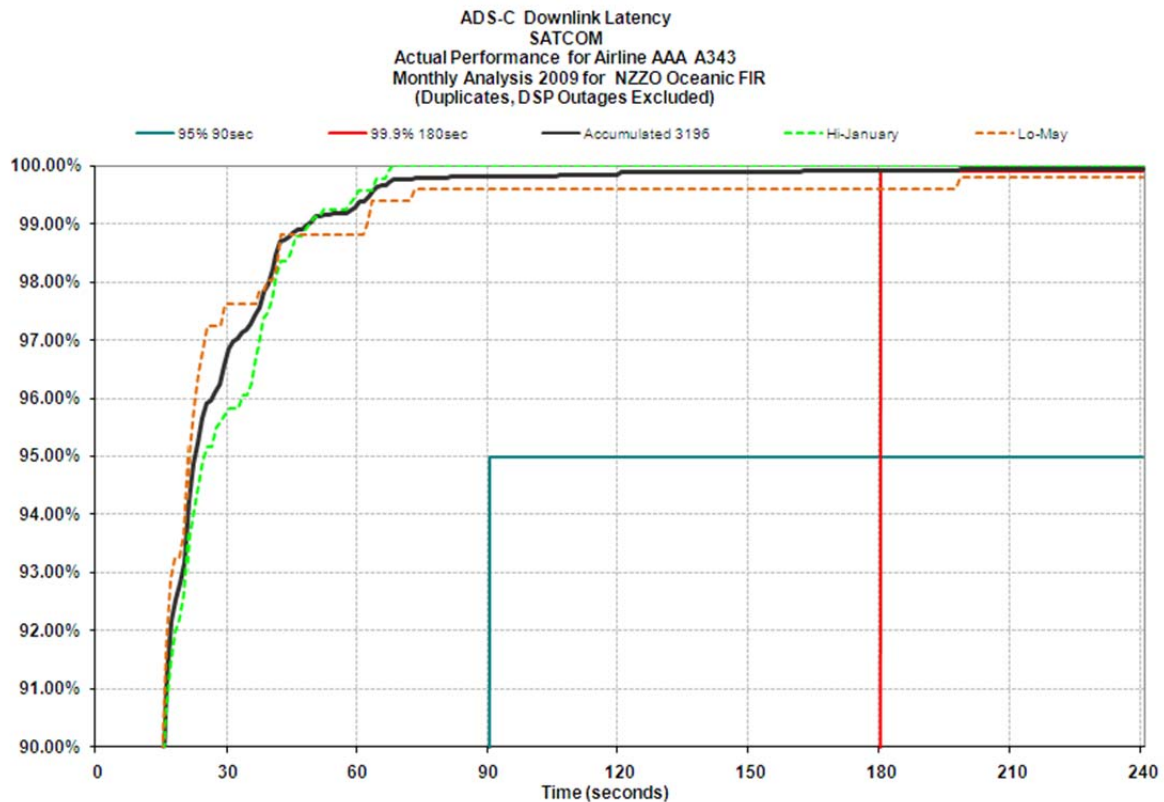

Figure D- 13. ADS-C A343 AAA via SATCOM NZZO FIR Jan – May 2009

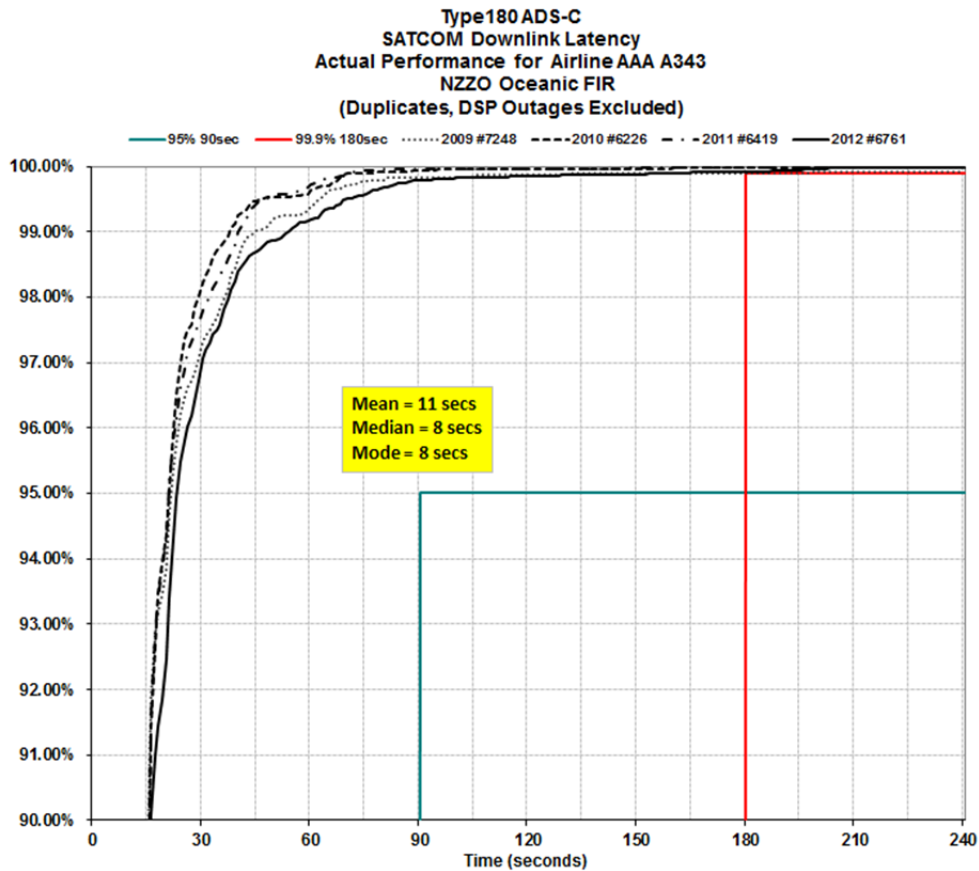

Figure D- 14 ADS-C A343 AAA via SATCOM NZZO FIR 2009-2012

D.2.4.5.3.3 A comparative analysis of the performance of different fleets operating in an ATSU's airspace particularly of fleets of the same type is useful. Under performing fleets can be identified for further analysis and a picture of typical performance from all fleets can be built up. These can be compared with the same fleets operating in other ATSUs' airspace.

D.2.4.5.3.4 [Figure D- 15](#) below graphs SATCOM transit times for a number of fleets operating in NZZO FIR for the period January – May 2009. Significant variations in observed performance such as with operator DDD B772 fleet can be flagged for further analysis as discussed in [paragraph D.2.4.6](#).

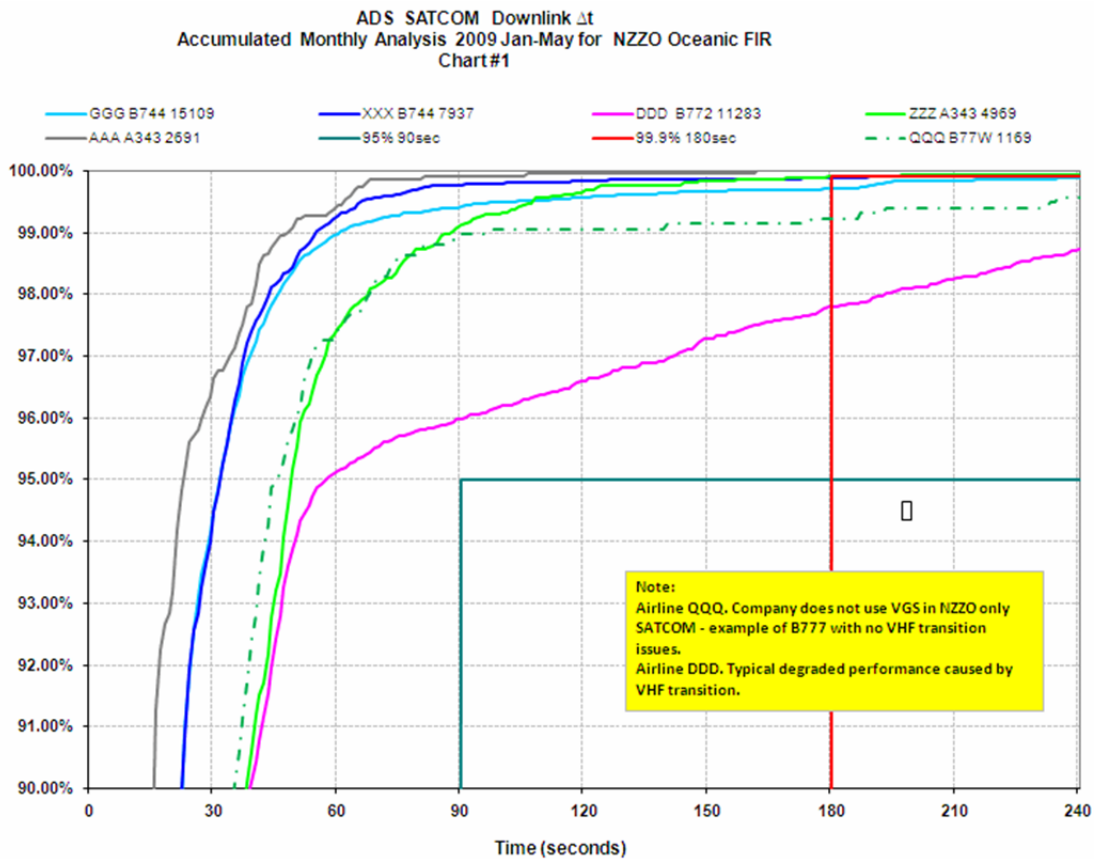

Figure D- 15. Comparative SATCOM ADS-C for different operators

D.2.4.5.3.5 The issue affecting operator DDD B772 fleet in [Figure D- 15](#) was identified by the regional CRA as an aircraft issue that affected all B777 aircraft. This was eventually resolved by a software upgrade. ANSP should note that software upgrades to aircraft may take some time to be implemented by all airlines. The current performance of operator DDD B772 fleet is depicted in [Figure D- 16](#).

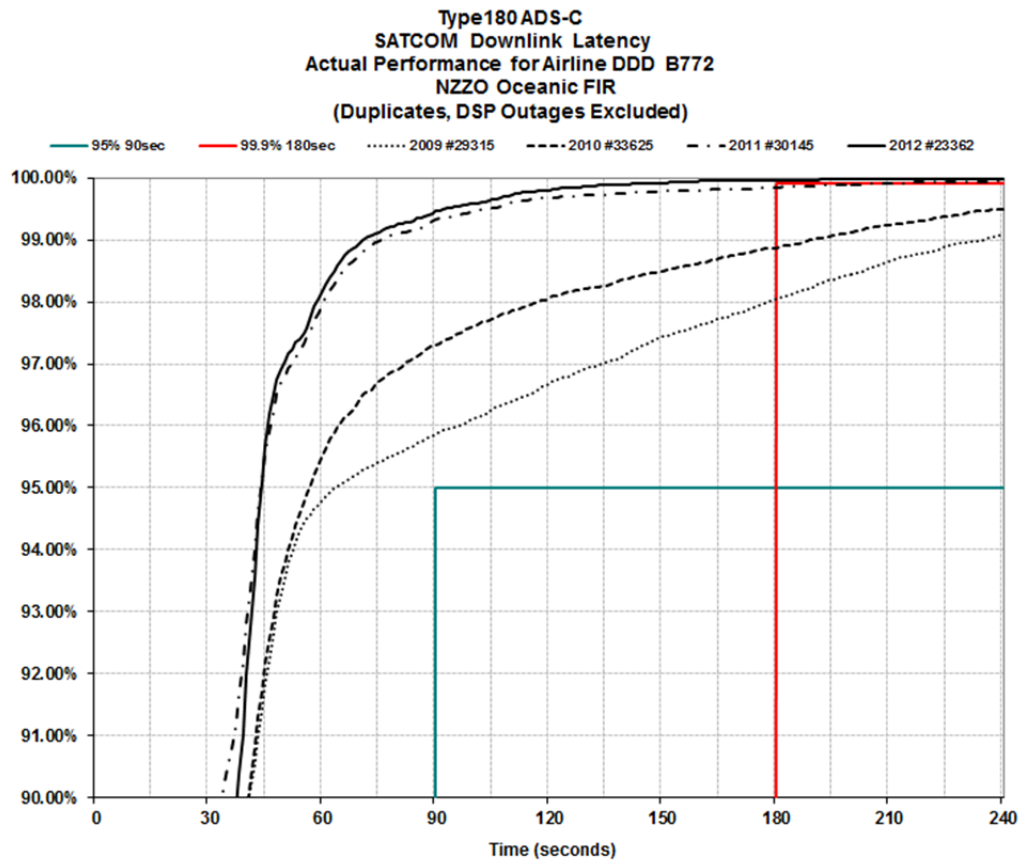

Figure D- 16 SATCOM ADS-C Operator DDD B777 2009-2012

D.2.4.6 Identifying poor performers

D.2.4.6.1 The reasons behind degraded performance are many and varied. Considerable analysis may be required before the reasons behind poor performing fleets are identified and it is difficult to provide guidance for all situations. Some analysis techniques that have been used by some ANSP with some success to identify reasons behind poor performance are provided in the following paragraphs.

D.2.4.6.2 On a number of occasions poor performance has been attributed to a specific aircraft in a fleet. Usually these poor-performing aircraft can be identified by the visual inspection of monthly data ordered in terms of transit time, or more accurately by graphing the monthly data for a fleet by aircraft registration.

D.2.4.6.3 Techniques such as graphing the positions of all delayed messages on a geographical display have identified areas for further investigation.

D.2.4.6.4 There are low speed (600 bps and 1200 bps) and high speed (10500 bps) data rates defined for the P, R, and T SATCOM channels. Some aircraft are capable of low speed SATCOM only. Other aircraft are capable of both high speed and low speed. However, not all aircraft that are capable of high speed operation have enabled the use of high speed SATCOM and, instead operate in low speed only. It is recommended an operator using low speed SATCOM channels change to the high speed channels where possible. Low or high speed channel use is selectable by an individual operator in the aircraft operational requirements table (ORT).

D.2.4.6.5 Significant performance benefits accrue with the use of the high speed channels as illustrated in the figure D-10 below.

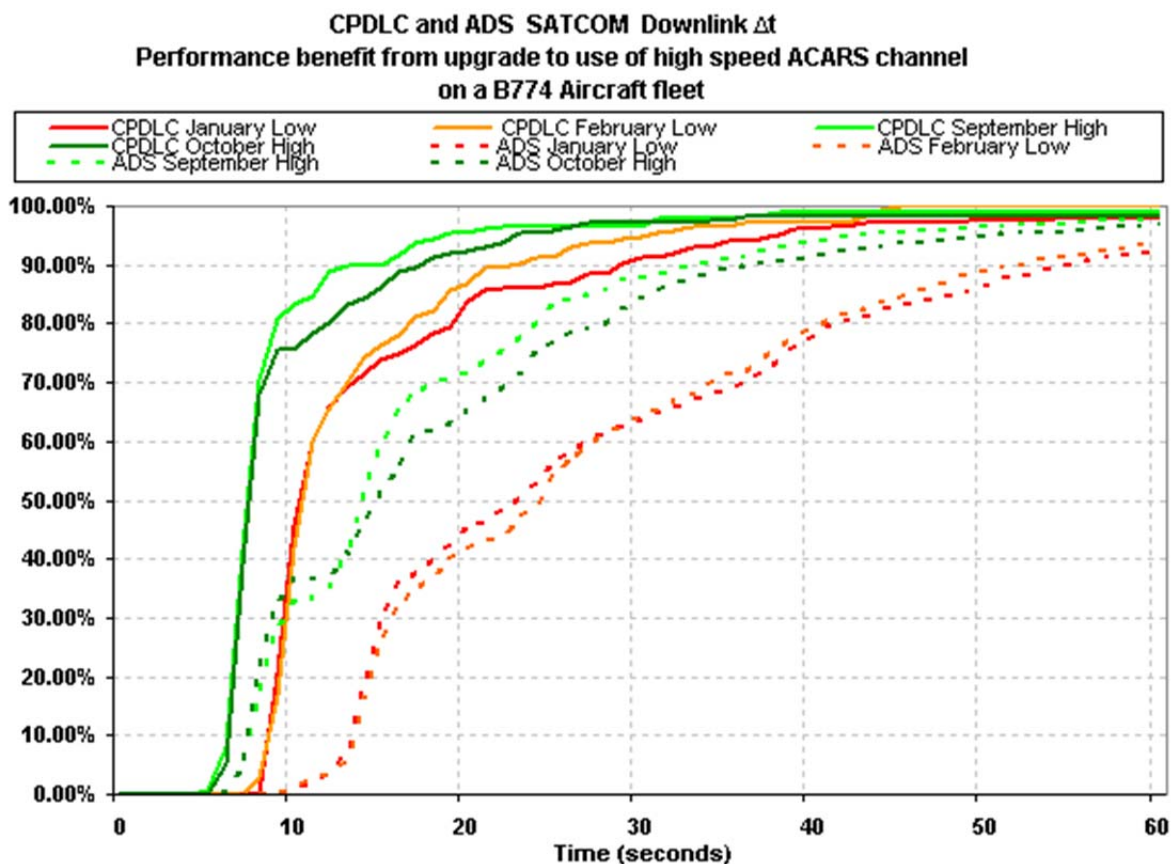

Figure D- 17. Effect of ACARS channel speed on ADS-C surveillance data transit time

D.2.4.6.6 An ANSP can assess ACARS channel speed use by evaluating the monthly downlink times for ADS-C reports via SATCOM. For users of high speed channels ANSP will consistently see a small percentage of reports in the 6-8 second time bands. Low speed channels users usually have very few reports less than 10 seconds.

D.2.4.6.7 ANSP should identify those operators using the low speed channels and stakeholders should work with those operators to achieve an upgrade to the high speed channels.

D.2.4.7 Assessing periodic monitoring results

D.2.4.7.1 The 95% and 99.9% criteria are provided as operationally significant benchmarks against which the surveillance and communication applications supporting ATM functions can be assessed.

D.2.4.7.2 Typically post implementation monitoring is carried out on a monthly basis and observed performance assessed to detect any performance degradation.

D.2.4.7.3 99.9% criteria

D.2.4.7.3.1 The 99.9% criteria define the Expiry Time (ET) for communication transactions and the Overdue Time (OT) for surveillance transactions following which the initiator is required to revert to an alternative procedure. When using data link to provide reduced separations, the RCP240 ET and RSP180 OT are the times after which if a CPDLC intervention transaction is not completed or an ADS-C position report is not received, then the controller is obliged to revert to alternative separation procedure as defined in the separation specification. If monthly monitoring shows that a specific fleet is not meeting the criteria then a local safety assessment by the ANSP should be carried out to assess if the reduced separation standard can continue to be applied. Some ANSP have set monitoring guidelines as to trigger a safety assessment and further investigation. The safety assessment would consider the density of traffic and traffic patterns flown in the region together with the frequency of application of the reduced separation to assess whether the increased probability of having to revert to an alternative separation would have workload and thus safety implications for the controllers. The safety assessment would also consider the performance of other fleets operating in the airspace.

D.2.4.7.4 95% criteria

D.2.4.7.4.1 The 95% criteria define the nominal time acceptable for normal CPDLC and ADS-C operations. If monthly monitoring shows that measured performance is consistently below the 95% criteria then consideration may be given to the withdrawal of data link services to the fleet. Experience has shown that observed fleet performance below the specified RCP240/RSP180 95% criteria will usually be accompanied by controller complaints of unacceptable performance by that fleet.

D.2.4.7.5 Setting guidelines

D.2.4.7.5.1 In airspace where procedural separation is being applied, it has been observed that complete withdrawal of data link may not be required even if performance is observed to fall below the RCP240/RSP180 criteria. While safety services such as reduced separation standards requiring RCP240/RSP180 would be withdrawn the observed performance may still meet RCP/RSP400 criteria and the local safety assessment may also conclude that maintaining the data link connection is viable.

D.2.4.7.5.2 Some ANSP have set monitoring guidelines to assist with their data analysis. These include:

- a) If the performance observed for a fleet by monthly monitoring at the 99.9% level is better than 99.75% then the fleet is considered to meet the 99.9% performance level.
- b) Observed fleet performance consistently falling below 99.0% will be subject to CRA problem reports and investigation that will attempt to determine the cause of the degradation.
- c) Any monthly performance degradation (0.5%) by a fleet below observed historical performance will be subject to investigation.

D.2.4.7.6 Case study

D.2.4.7.6.1 In early 2009 analysis of the performance data for December 2008 in NZZO detected a slight performance degradation for both ADS-C and CPDLC against the monitored RCP240/RSP180 standard. Further performance deterioration was observed mid February 2009 when the January 2009 data was assessed.

D.2.4.7.6.2 During this period further local analysis was initiated and by March 2009 a CRA problem report had been raised and a full investigation was underway by the CRA and the CSP's. Further deterioration in performance was noted in the following months through to October 2009.

D.2.4.7.6.3 ADS-C performance for the fleet as measured against the RSP180 performance standard is illustrated in Figure D-17 and CPDLC performance as measured against the RCP240 performance standard is illustrated in Figure D-18.

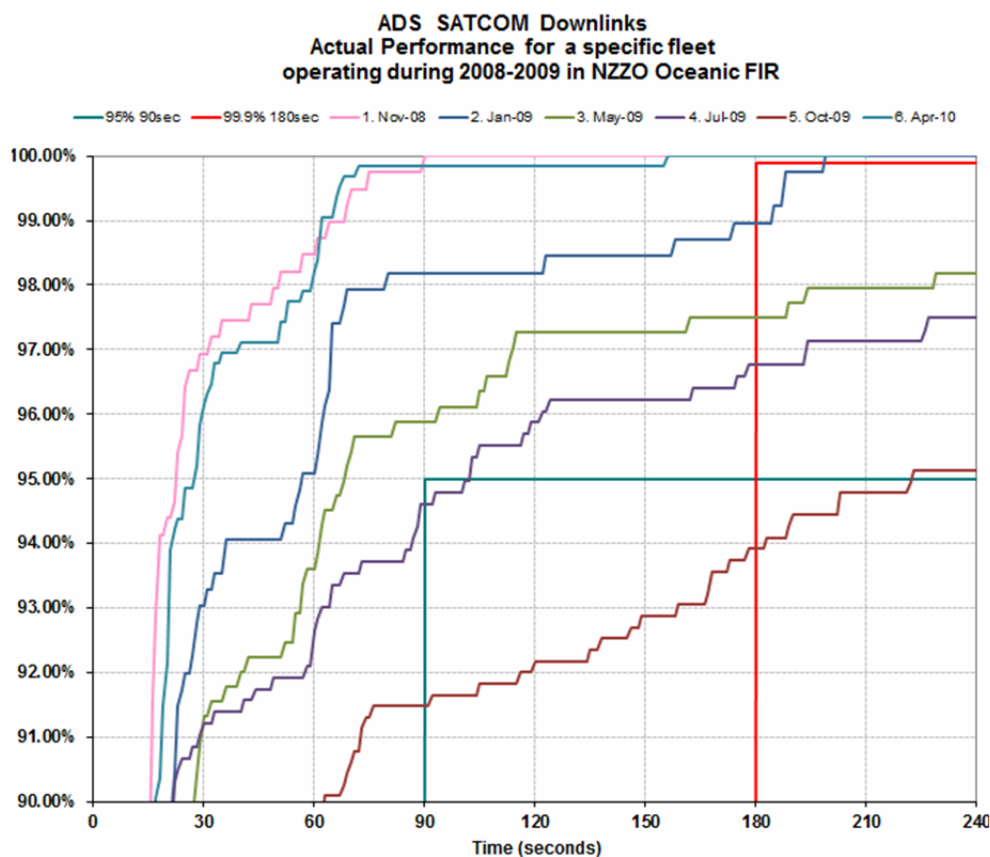

Figure D- 18 Example of ADS-C performance deterioration

D.2.4.7.6.4 A safety assessment in early 2009 concluded that reduced separation standards using data link would be withdrawn although CPDLC and ADS-C would continue to be used.

D.2.4.7.6.5 The cause of the problem was identified in mid 2009 as a system level GES issue. This was caused by the implementation of new cabin services on the aircraft that were gradually installed on the fleet from late 2008 until the middle of 2009. This explained the continuing performance degradation through this period.

D.2.4.7.6.6 A software fix was released in early 2010 with observed performance levels for the fleet returning to normal immediately and meeting the RSP180/RCP240 standard.

D.2.4.7.6.7 Reduced separation standards were restored to the fleet in April 2009 after monitoring had demonstrated that performance standard compliance had been achieved.

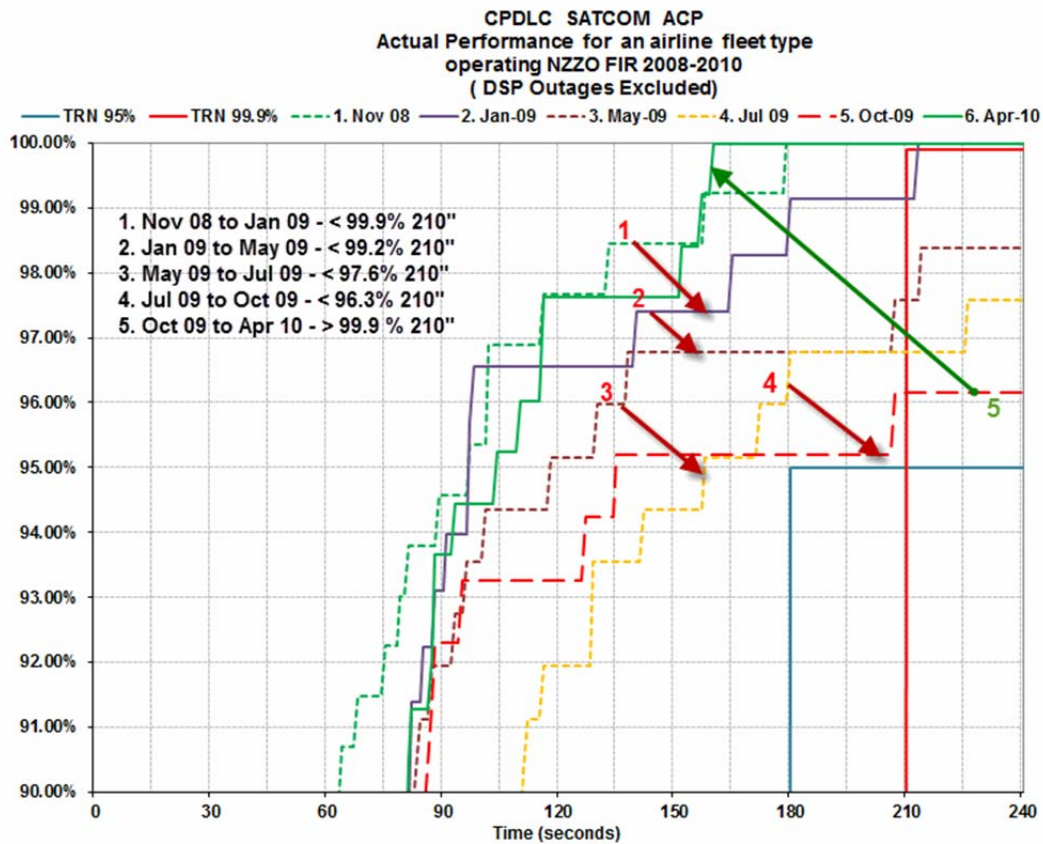

Figure D- 19 Example of CPDLC ACP performance deterioration

D.3 Problem reporting and resolution

D.3.1 General

D.3.1.1 The working principles in this guidance material result from the combined experience of the North Atlantic, Asia-Pacific, South American, African-Indian Ocean, and European Regions. Many regions have formed a regional monitoring agency to manage the problem reporting and resolution process.

D.3.1.2 All stakeholders should be actively involved in the problem reporting and resolution process. It is essential that all aircraft operators in a region have the opportunity to become involved in the process and CRA's should be pro-active in getting all aircraft operators and other stakeholders to register and participate in the process.

D.3.1.3 The problem identification and resolution process, as it applies to an individual problem, consists of a data collection phase, followed by problem analysis and coordination with affected parties to secure a resolution, and recommendation of interim procedures to mitigate the problem in some instances. This is shown in the [Figure D- 20](#).

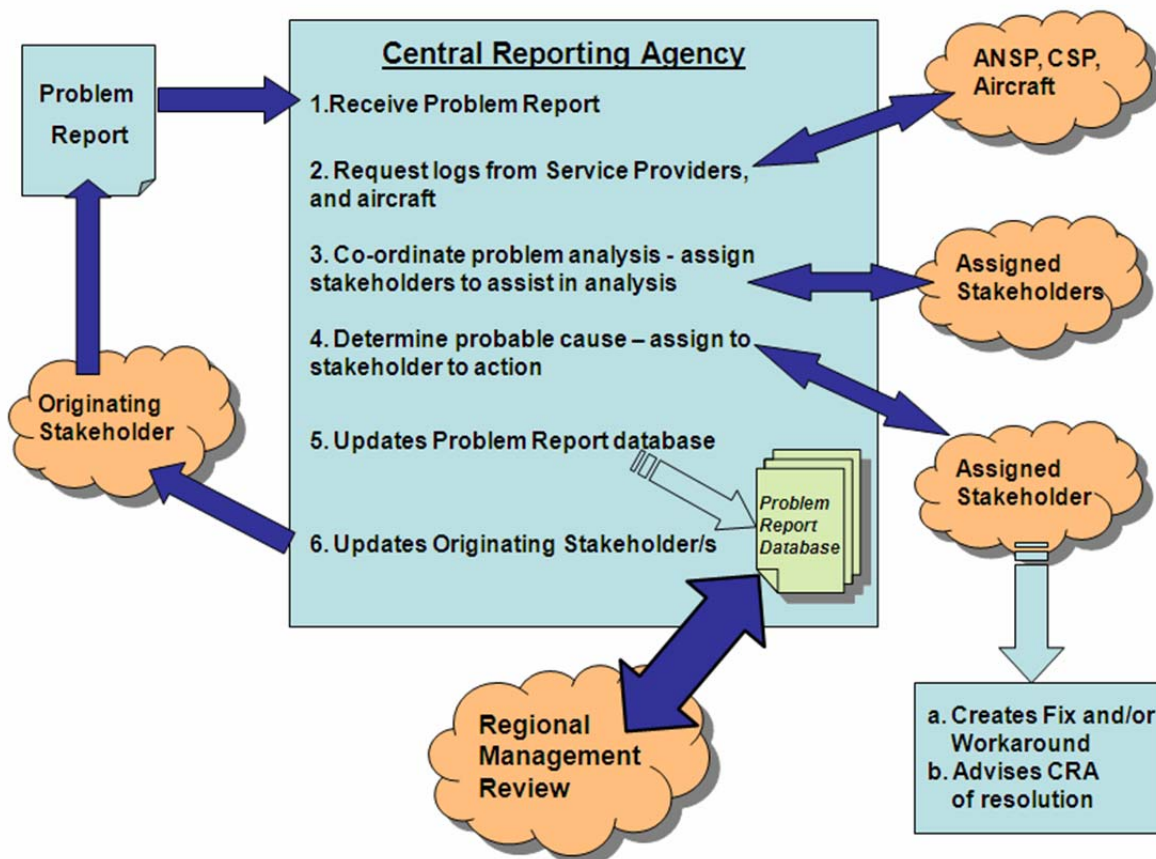

Figure D- 20. Problem reporting and resolution process

D.3.2 Problem report form

D.3.2.1.1 The problem identification task begins with receipt of a problem report from a stakeholder, usually an operator, ANSP or CSP but may include aircraft or avionics manufacturers. Standard reporting forms should be developed and regions should investigate the use of a website to receive and store problem reports.

D.3.2.1.2 As an example, the EUR region uses JIRA (<http://www.eurocontrol.int/link2000/wiki/index.php/>), a secured web-based problem reporting and tracking application, which is managed by the LINK2000+/Central Reporting Office of EUROCONTROL. Problems should be reported, regardless whether it can be resolved locally or needs to be handled to promote knowledge sharing across the data link community.

D.3.2.1.3 An example of an online problem reporting form currently used on-line by regional CRA in the NAT, and Asia Pacific regions is shown in [Figure D- 21](#). The fields used in the form are as follows:

- a) Originator's Reference Number: Originators problem report reference (e.g. ANZ_2009-23);

- b) Title: A short title which conveys the main issue of the reported problem (e.g. CPDLC transfer failure);
- c) Date UTC: Date in YYYYMMDD format (e.g. 20090705);
- d) Time UTC: Time in HHMM (e.g. 2345);
- e) Aircraft registration: ICAO flight plan aircraft registration (e.g. ZKADR);
- f) Aircraft identification: ICAO flight plan call sign if applicable (e.g. NZA456);
- g) Flight Sector: If applicable the departure and destination airfield of the flight (e.g. NZAA-RJBB);
- h) Organization: Name of the originators organization (e.g. Airways NZ);
- i) Active Center: Controlling Centre at time of occurrence if applicable (e.g. NZZO);
- j) Next Center: Next controlling centre at time of occurrence if applicable (e.g. NFFF);
- k) Position: Position of occurrence (e.g. 3022S16345E);
- l) Problem Description: Detailed description of problem;
- m) Attach File: Area of web page where originator and assigned stakeholders can attach data files or other detailed information such as geographic overlays; and
- n) Additional Data: Area set aside for feedback from stakeholders assigned by the regional/State monitoring agency. This will include the results of the investigation and the agreed action plan.

Note.— A number of regional monitoring agencies are developing websites to manage the problem reporting process. Website addresses and the regional monitoring agency to which they are applicable are listed in [Appendix E](#).

FANS 1/A Problem Report Form

Form Details			
Originators Reference Number			<input type="text"/>
Title	<input type="text"/>		
Date UTC	<input type="text"/>	Time UTC	<input type="text"/>
Registration	<input type="text"/>	Flight Number	<input type="text"/>
Flight Sector	<input type="text"/>		
Originator	<input type="text"/>	Aircraft Type	<input type="text"/>
Organisation	<input type="text"/>		
Active Center	<input type="text"/>	Next Center	<input type="text"/>
Postion	<input type="text"/>		
Problem Description (box will expand as you type)	<input type="text"/>		
Attach File	<input type="text"/>	Browse...	(click browse - do not type in this field)
	<input type="text"/>	Browse...	(click browse - do not type in this field)
	<input type="text"/>	Browse...	(click browse - do not type in this field)
	<input type="text"/>	Browse...	(click browse - do not type in this field)
	<input type="text"/>	Browse...	(click browse - do not type in this field)
Additional Data	<input type="text"/>		
<input type="button" value="Submit PR"/>			

Figure D- 21, Example on-line problem reporting form

D.3.3 Problem assessment

D.3.3.1 Data collection

D.3.3.1.1 The data collection phase consists of obtaining message logs from the appropriate parties (which will depend on which ANSPs and CSPs were being used and operator service contracts). Today, this usually means obtaining logs for the appropriate period of time from the CSPs involved. Usually, a log for a few hours before and after the event that was reported will suffice, but once the analysis has begun, it is sometimes necessary to request additional data, (perhaps for several days prior to the event if the problem appears to be an on-going one).

D.3.3.1.2 Additionally, some aircraft-specific recordings may be available that may assist in the data analysis task. These are not always requested initially as doing so would be an unacceptable imposition on the operators, but may occur when the nature of the problem has been clarified enough to indicate the line of investigation that needs to be pursued. These additional records include:

- a) Aircraft maintenance system logs.
- b) Built-In Test Equipment data dumps for some aircraft systems.
- c) SATCOM activity logs.
- d) Logs and printouts from the flight crew and recordings/logs from the ANSPs involved in the problem may also be necessary. It is important that the organization collecting data for the analysis task requests all this data in a timely manner, as much of it is subject to limited retention.

D.3.3.2 Data analysis

D.3.3.2.1 Once the data has been collected, the analysis can begin. For this, it is necessary to be able to decode all the messages involved, and a tool that can decode every ATS data link message type used in the region is essential. These messages include:

- a) AFN (ARINC 622), ADS-C and CPDLC (RTCA DO-258/EUROCAE ED-100) in a region operating FANS-1/A.
- b) Context Management, ADS-C and CPDLC applications (ICAO Doc 9705 and RTCA DO-280B/ED-110B) in a region using ATN B1.
- c) ARINC 623 messages used in the region.

D.3.3.2.2 The analysis of the decoded messages requires a thorough understanding of the complete message traffic, including:

- a) Media management messages.
- b) Relationship of ground-ground and air-ground traffic.
- c) Message envelope schemes used by the particular data link technology (ACARS, ATN, etc).

D.3.3.2.3 The analyst must also have a good understanding of how the aircraft systems operate and interact to provide the ATS data link functions, as many of the reported problems are aircraft system problems.

D.3.3.2.4 This information will enable the analyst to determine a probable cause by working back from the area where the problem was noticed to where it began. In some cases, this may entail manual decoding of parts of messages based on the appropriate standard to identify particular encoding errors. It

may also require lab testing using the airborne equipment (and sometimes the ground networks) to reliably assign the problem to a particular cause.

D.3.3.2.5 Once the problem has been identified, then the task of coordination with affected parties begins. The stakeholder who is assigned responsibility for fixing the problem must be contacted and a corrective action plan agreed. The stakeholder who initiated the problem report shall be provided with regular updates on the progress and resolution of the problem

D.3.3.2.6 This information (the problem description, the results of the analysis and the plan for corrective action) is then entered into a database covering data link problems, both in a complete form to allow continued analysis and monitoring of the corrective action and in a de-identified form for the information of other stakeholders. These de-identified summaries are reported at the appropriate regional management forum and made available to other regional central reporting/monitoring agencies on request.

D.3.4 Mitigating procedures – problem resolution

D.3.4.1 The regional monitoring agency's responsibility does not end with determining the cause of the problem and identifying a fix. As part of that activity, and because a considerable period may elapse while software updates are applied to all aircraft in a fleet, procedural methods to mitigate the problem may have to be developed while the solution is being coordinated. The regional monitoring agency should identify the need for such procedures and develop recommendations for implementation by the ANSPs, CSPs and operators involved.

D.4 Regional performance monitoring

D.4.1 General

D.4.1.1 This section provides guidance on periodic reporting by individual ANSP of observed system performance in their airspace that will enable regional performance metrics to be developed for the availability, CPDLC transaction time and ADS-C surveillance data transit time requirements specified in [Appendix B](#) and [Appendix C](#).

D.4.1.2 These regional performance metrics should be made available to all interested stakeholders. The use of regional websites to enhance the distribution of these metrics should be considered. An example of such a website can be viewed at <http://www.ispacg-cra.com/>.

D.4.1.3 It is recommended that regions implement monthly performance reporting to obtain system performance metrics. These reports will provide data on observed availability, CPDLC transaction time and ADS-C surveillance data transit time as described herein.

D.4.2 Reporting on availability

D.4.2.1 ANSP should report on CSP notified system outages and on detected outages that have not been notified as described in [paragraph D.2.4.3.2](#). This is used to calculate the actual availability of service provision.

D.4.2.2 For each outage the following information should be reported:

a) Time of CSP outage notification: In YYYYMMDDHHMM format or “Not Notified” if no CSP notification received.

- b) CSP Name: Name of CSP providing outage notification if applicable.
- c) Type of outage: Report media affected SATCOM, VHF, HF, ALL.
- d) Outage start time: In YYYYMMDDHHMM format
- e) Outage end time: In YYYYMMDDHHMM format
- f) Duration of Outage: In minutes.

D.4.2.3 As per [Appendix B](#) only outages greater than 10 minutes are reported. An example form is shown in [Figure D- 24](#).

D.4.2.4 For EUR region, the number of Provider Aborts experienced by the ANSP and manually reported availability problems affecting a single aircraft should be reported. This provides an acceptable indication of the actual Availability of Use.

D.4.2.5 ANSP can use graphical analysis to track availability as illustrated in [Figure D- 22](#) and [Figure D- 23](#).

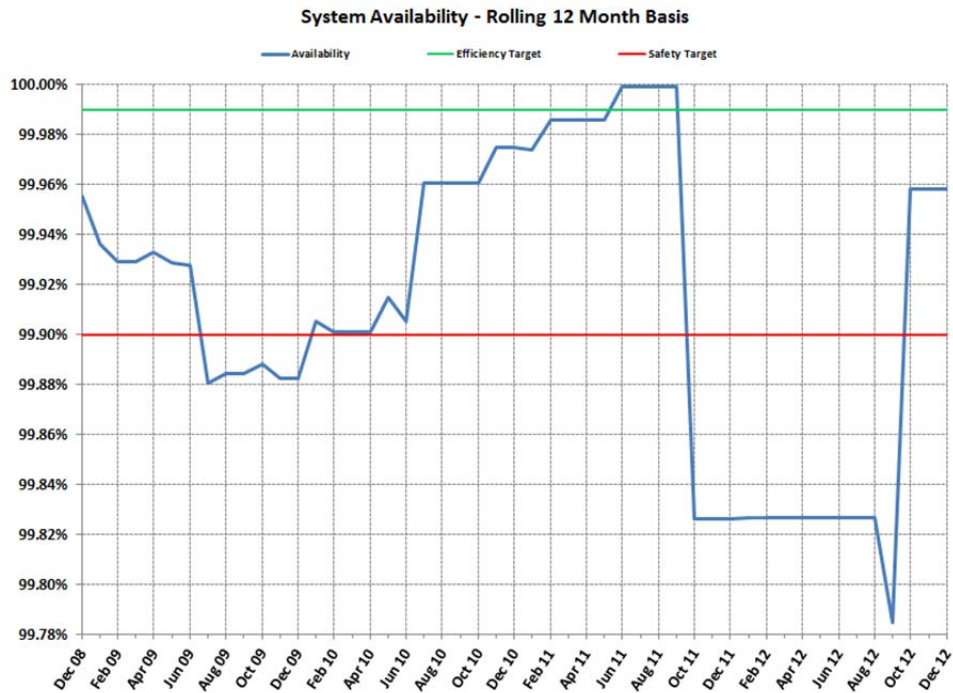

Figure D- 22 Example system availability graph

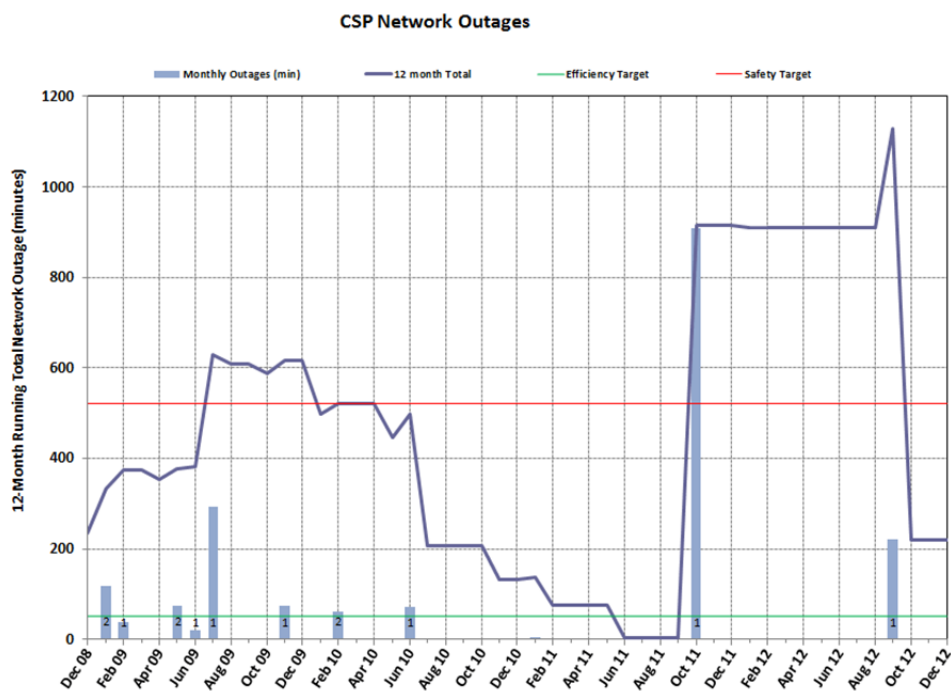

Figure D- 23 Example network outage graph

D.4.3 Reporting on CPDLC actual communications performance

D.4.3.1 ANSP should report observed ACP and ACTP for RCP240 and RCP400 for different media paths using all transactions involving a WILCO response as described in [paragraph D.2.4](#). The media paths to report are:

- a) From all aircraft via all remote ground station (RGS) types.
- b) From all aircraft where both uplink and downlink are via SATCOM RGS
- c) From all aircraft where both uplink and downlink are via VHF RGS
- d) From all aircraft where both uplink and downlink are via HF RGS
- e) From all aircraft where either uplink and downlink are via HF or SATCOM RGS

D.4.3.2 A tabular reporting format can be used to capture the observed performance at the 95% and 99.9% RCP240/400 times.

D.4.3.3 As PORT is independent of media path, this need only be reported for all RGS types. An example form is shown in [Figure D- 24](#).

D.4.3.4 ANSPs within the EUR region should record the observed ACP and ACTP and CPDLC-flight crew-initiated log files for different media paths using all transactions requiring a response. In addition, it should record the observed ACP and ACTP for DLIC-Contact/CPDLC log files and ATN B1 transport level log files, deployment and system health log files in the standardised XML-format as described in paragraph D.1.1.2. All ANSPs send the log files to the CRO for importing into PRISME

(Pan-European Repository of Information Supporting the Management of EATM). PRISME is an integrated ATM data ware house for creation of various performance monitoring reports (e.g. EUR network, an ANSP, an Aircraft Operator, particular avionics configuration).

D.4.3.5 The EUR network performance monitoring reports are published on the CRO website. The reports at the other levels (per ANSP, per Aircraft Operator and per Avionics configuration) would normally be restricted to just EUROCONTROL and the relevant stakeholder.

D.4.4 Reporting on RSP data transit time

D.4.4.1 ANSP should report observed RSP data transit time for RSP 180 and RSP 400 and DO290/ED120 based performance specifications for different media paths as described in [paragraph D.2.4](#). The media paths to report are:

- a) From all aircraft via all Remote Ground Station (RGS) types.
- b) From all aircraft where both uplink and downlink are via SATCOM RGS
- c) From all aircraft where both uplink and downlink are via VHF RGS
- d) From all aircraft where both uplink and downlink are via HF RGS
- e) From all aircraft where either uplink and downlink are via HF or SATCOM RGS

D.4.4.2 A tabular reporting format can be used to capture the observed performance at the 95% and 99.9% RSP 180 and RSP 400 times. An example form is shown in [Figure D- 24](#).

Monthly Report of Datalink Performance by < ANSP Name> for < FIR Name > for <month> <year>								
Section 1: Availability								
CSP Notification	CSP Name	Outage Type	Start	End	Duration (Mins)			
200907150005	ARINC	SATCOM	200907150001	200907150020	19			
Not Notified	N/A	SATCOM	200907212233	200907212255	22			
200907281515	SITA	VHF	200907281510	200907281525	15			
Section 2: CPDLC								
ALL RGS			SATCOM					
ACTP RCP240	120sec	98.20%	ACTP RCP240	120sec				
	150sec	100%		150sec				
ACP RCP240	180sec	98%	ACP RCP240	180sec				
	210sec	99.70%		210sec				
PORT	60sec	98%						
ACTP RCP400	260sec		ACTP RCP400	260sec				
	310sec			310sec				
ACP RCP400	320sec		ACP RCP400	320sec				
	370sec			370sec				
VHF			HF					
ACTP RCP240	120sec		ACTP RCP240	120sec				
	150sec			150sec				
ACP RCP240	180sec		ACP RCP240	180sec				
	210sec			210sec				
ACTP RCP400	260sec		ACTP RCP400	260sec				
	310sec			310sec				
ACP RCP400	320sec		ACP RCP400	320sec				
	370sec			370sec				
SATCOM + HF								
ACTP RCP240	120sec							
	150sec							
ACP RCP240	180sec							
	210sec							
ACTP RCP400	260sec							
	310sec							
ACP RCP400	320sec							
	370sec							
Section 3: ADS-C								
ALL RGS						SATCOM		
ASP RSP180	90sec	98.80%	ASP RSP180	90sec				
	180sec	100%		180sec				
ASP RSP400	300sec		ASP RSP400	300sec				
	400sec			400sec				
VHF			HF					
ASP RSP180	90sec		ASP RSP180	90sec				
	180sec			180sec				
ASP RSP400	300sec		ASP RSP400	300sec				
	400sec			400sec				
SATCOM + HF								
ASP RSP180	90sec							
	180sec							
ASP RSP400	300sec							
	400sec							

Figure D- 24. Example ANSP monthly report

D.4.5 Reporting data to enable graphical reports

D.4.5.1 In addition to the tabular performance reporting described above regions should consider presenting performance data using graphical means. Performance graphs illustrating regional communications and surveillance performance for the different media paths can be readily obtained by aggregating spreadsheet data from individual ANSP as illustrated in [Figure D-25](#). This figure illustrates part of an ANSP report of actual performance for ACTP, ACP, and PORT against the RCP240 requirements for a particular media type where the number of messages received within a time is recorded at one second intervals. This type of data can be included in an ANSP monthly report to enable regional aggregation of agreed performance information to allow it to be presented in graphical form. Regions could present all or some of the data reported in tabular form per [paragraphs D.4.3 and D.4.4](#) above in graphical form if desired. This method of reporting would also assist global aggregation.

ACTP#	ACTP%	ACP#	ACP%	CREW#	CREW%	t"								
0	0.00%	0	0.00%	149	0.89%	0		16660	99.65%	16540	98.94%	16655	99.62%	200
0	0.00%	0	0.00%	176	1.05%	1		16660	99.65%	16543	98.95%	16656	99.63%	201
0	0.00%	0	0.00%	210	1.26%	2		16662	99.67%	16547	98.98%	16656	99.63%	202
0	0.00%	0	0.00%	322	1.93%	3		16662	99.67%	16549	98.99%	16656	99.63%	203
0	0.00%	0	0.00%	673	4.03%	4		16662	99.67%	16549	98.99%	16656	99.63%	204
0	0.00%	0	0.00%	1444	8.64%	5		16662	99.67%	16550	99.00%	16657	99.64%	205
1	0.01%	0	0.00%	2330	13.94%	6		16662	99.67%	16553	99.01%	16657	99.64%	206
29	0.17%	0	0.00%	3133	18.74%	7		16662	99.67%	16556	99.03%	16657	99.64%	207
988	5.91%	0	0.00%	3946	23.60%	8		16662	99.67%	16561	99.06%	16657	99.64%	208
3939	23.56%	0	0.00%	4731	28.30%	9		16664	99.68%	16563	99.07%	16659	99.65%	209
6726	40.23%	0	0.00%	5667	33.90%	10		16664	99.68%	16564	99.08%	16662	99.67%	210
8519	50.96%	0	0.00%	6763	40.45%	11		16664	99.68%	16565	99.08%	16662	99.67%	211
9566	57.22%	3	0.02%	7811	46.72%	12		16664	99.68%	16566	99.09%	16662	99.67%	212
10585	63.31%	13	0.08%	8794	52.60%	13		16666	99.69%	16567	99.10%	16663	99.67%	213
11356	67.93%	33	0.20%	9594	57.39%	14		16667	99.69%	16571	99.12%	16663	99.67%	214
11910	71.24%	67	0.40%	10355	61.94%	15		16667	99.69%	16572	99.13%	16665	99.68%	215
12401	74.18%	136	0.81%	10964	65.58%	16		16667	99.69%	16574	99.14%	16665	99.68%	216
12962	77.53%	232	1.39%	11483	68.69%	17		16667	99.69%	16575	99.14%	16665	99.68%	217
13530	80.93%	609	3.64%	11899	71.17%	18		16667	99.69%	16576	99.15%	16666	99.69%	218
13938	83.37%	1949	11.66%	12267	73.38%	19		16669	99.71%	16577	99.16%	16666	99.69%	219
14247	85.22%	3280	19.62%	12595	75.34%	20		16669	99.71%	16579	99.17%	16666	99.69%	220
14415	86.22%	4326	25.88%	12867	76.96%	21		16669	99.71%	16580	99.17%	16666	99.69%	221
14586	87.25%	5362	32.07%	13145	78.63%	22		16672	99.72%	16581	99.18%	16666	99.69%	222
14724	88.07%	6308	37.73%	13387	80.08%	23		16673	99.73%	16583	99.19%	16666	99.69%	223
14839	88.76%	7057	42.21%	13588	81.28%	24		16674	99.74%	16586	99.21%	16666	99.69%	224
14943	89.38%	7766	46.45%	13764	82.33%	25		16675	99.74%	16586	99.21%	16667	99.69%	225
15029	89.90%	8388	50.17%	13930	83.32%	26		16675	99.74%	16589	99.23%	16667	99.69%	226
15128	90.49%	8977	53.70%	14098	84.33%	27		16675	99.74%	16589	99.23%	16667	99.69%	227
15220	91.04%	9494	56.79%	14249	85.23%	28		16676	99.75%	16593	99.25%	16668	99.70%	228
15323	91.66%	9968	59.62%	14425	86.28%	29		16677	99.75%	16594	99.26%	16668	99.70%	229
15402	92.13%	10373	62.05%	14562	87.10%	30		16677	99.75%	16596	99.27%	16668	99.70%	230
15448	92.40%	10763	64.38%	14696	87.91%	31		16677	99.75%	16597	99.28%	16668	99.70%	231
15501	92.72%	11102	66.41%	14826	88.68%	32		16677	99.75%	16598	99.28%	16668	99.70%	232
15543	92.97%	11433	68.39%	14938	89.35%	33		16677	99.75%	16601	99.30%	16668	99.70%	233
15599	93.31%	11720	70.10%	15049	90.02%	34		16677	99.75%	16604	99.32%	16668	99.70%	234
15640	93.55%	11985	71.69%	15160	90.68%	35		16678	99.76%	16604	99.32%	16668	99.70%	235
15683	93.81%	12235	73.18%	15258	91.27%	36		16678	99.76%	16605	99.32%	16668	99.70%	236
15720	94.03%	12477	74.63%	15338	91.75%	37		16679	99.77%	16606	99.33%	16668	99.70%	237
15747	94.19%	12703	75.98%	15405	92.15%	38		16679	99.77%	16607	99.34%	16668	99.70%	238
15790	94.45%	12908	77.21%	15476	92.57%	39		16680	99.77%	16609	99.35%	16668	99.70%	239
15813	94.59%	13111	78.42%	15533	92.91%	40		16681	99.78%	16609	99.35%	16668	99.70%	240
15851	94.81%	13289	79.49%	15603	93.33%	41		37	0.22%	109	0.65%	50	0.30%	>240
								16718	100.00%	16718	100.00%	16718	100.00%	Total

Figure D-25. Example ANSP monthly report that will enable graphical analysis

Appendix E Regional/State-specific information

E.1 General

E.1.1 This Appendix provides Regional/State specific information grouped per ICAO Regions pertaining to the data link operations.

E.2 Africa-Indian Ocean (AFI) Region

E.2.1 Administrative provisions related to data link operations

Table E-AFI- 1. Data link services by control area (CTA)

Control area (CTA)	CPDLC	ADS-C	FMC WPR	AFN address	ATSU ACARS Address	Coord Group	Remarks
Accra				DGAC			
Abidjan				DIII			
Algeria (Alger)	O	O	N	DAAA			
Antananarivo (Madagascar)	O	O	N	FMMM			
Brazzaville				FCCC			
Canarias				GCCC			
Capetown	O	O	N	FACT			
Casablanca							
Dakar Oceanic (Senegal)	O	O	N	GOOO	DKRCAYA		
Johannesburg Oceanic	O	O	N	FAJO	JNBCAYA		Confirm CPDLC CDA: One CPDLC position report at boundary.
Luanda							
Mauritius	O	O	N	FIMM			Confirm CPDLC CDA: One CPDLC position report at boundary.
Niamey (Niger)	O	O	N	DRRR			
Sal Oceanic				GVSC			

Control area (CTA)	CPDLC	ADS-C	FMC WPR	AFN address	ATSU ACARS Address	Coord Group	Remarks
Tunis							

E.2.2 Controller and radio operator procedures

NIL

E.2.3 Flight crew procedures

NIL

E.2.4 Advanced data link operations

NIL

E.2.5 State aircraft data link operation

NIL

E.3 Caribbean (CAR) Region

E.3.1 Administrative provisions related to data link operations

Table E-CAR- 1. Data link services by control area (CTA)

Control area (CTA)	CPDLC	ADS-C	FMC WPR	AFN address	ATSU ACARS Address	Coord Group	Remarks
Central American	T	T	N	MHCC		ANIWG	Currently trialing ADS-C and CPDLC. Primary communication via voice. Full HF reporting still required.
Curacao							
Habana							
Houston Oceanic							

Control area (CTA)	CPDLC	ADS-C	FMC WPR	AFN address	ATSU ACARS Address	Coord Group	Remarks
Kingston							
Mazatlan Oceanic	T	T	N	MMMX		ANIWG	Currently trialing ADS-C and CPDLC. Primary communication via voice. Full HF reporting still required.
Mexico							
Miami Oceanic							
Nassau							
New York Oceanic (south of 27 N)	O	O	N	KZWY	NYCODYA	NAT CNSG	DO NOT use CPDLC for position reporting. Use ADS-C or voice only. SELCAL check via HF are required for all FANS connected aircraft prior to entering the CTA/FIR. DO NOT send a CPDLC position report to confirm CDA prior to, or upon crossing the FIR.
Port-Au-Prince							
PIARCO	T	T	N	TTZP		ANIWG (NAM/CAR Air Navigation Implementation Working Group)	Currently trialing ADS-C and CPDLC. Primary communication via voice. Full HF reporting still required.
San Juan							
Santo Domingo							

E.3.2 Controller and radio operator procedures

NIL

E.3.3 Flight crew procedures

NIL

E.3.4 Advanced data link operations

NIL

E.3.5 State aircraft data link operation

NIL

E.4 European (EUR) Region

E.4.1 Administrative provisions related to data link operations

E.4.1.1 ANSP service provision

E.4.1.1.1 [Table E-EUR- 1](#) lists the flight information regions (FIRs) and Upper flight information regions (UIRs), where ATN B1, FANS 1/A or FANS 1/A-ATN B1 data link service is provided and indicates Logon address, ATSU ACARS Address (where applicable), the year of implementation (where available) and responsible regional coordinating group.

Note 1.— For foreseen implementation date and the CPDLC message set used by each State, refer to the AIP/AIC concerned.

E.4.1.1.2 ATN B1 data link services are provided above FL285. FL285 aims to govern data link equipment. However, this does not mean that CPDLC operations are limited above FL285. Several ANSPs use CPDLC in their upper airspace below FL285.

E.4.1.1.3 The use of CPDLC is conducted at the discretion of each responsible ACC and at the initiative of the flight crew. CPDLC is used for routine exchanges during en-route operations in the upper airspace and is not for time-critical situations. Communication exchanges by voice have priority over CPDLC exchanges at all times.\

Table E-EUR- 1. Data link services by control area (CTA)

Control area (CTA)	CPDLC	ADS-C	FMC WPR	Logon address	ATSU ACARS Address	Coord Group	Remarks
Bucuresti FIR	O	N	N	LRBB	N/A	LINK 2000+	ATN B1
Budapest FIR	O	N	N	LHCC	N/A	LINK 2000+	ATN B1

Control area (CTA)	CPDLC	ADS-C	FMC WPR	Logon address	ATSU ACARS Address	Coord Group	Remarks
Barcelona UIR	O	N	N	LECB	N/A	LINK 2000+	ATN B1
Bordeaux UAC	O	N	N	LFBB	N/A	LINK 2000+	ATN B1
Brest UAC	O	N	N	LFRR	N/A	LINK 2000+	ATN B1
Brindisi FIR	O	N	N	LIBB	N/A	LINK 2000+	ATN B1
Canarias UIR	O	N	N	GCCC	N/A	LINK 2000+	ATN B1
Finland UIR	O	N	N	EFIN	N/A	LINK 2000+	ATN B1 only in the area south of 61°30'N
Geneva UIR	O	N	N	LSAG	N/A	LINK 2000+	ATN B1
Hellas UIR	O	N	N	LGGG	N/A	LINK 2000+	ATN B1
Kobenhavn FIR	O	N	N	EKDK	N/A	LINK 2000+	ATN B1
Lisboa UIR	O	N	N	LPPC	TBD	LINK 2000+	ATN B1 FANS 1/A
Ljubljana FIR	O	N	N	LJLA	N/A	LINK 2000+	ATN B1
London UIR	O	O	N	EGTT	TBD	LINK 2000+	ATN B1 FANS 1/A.
Madrid UIR	O	N	N	LECM	N/A	LINK 2000+	ATN B1
Magadan (Russia)	O	O	N	GDXB		???	FANS 1/A
Malta UIR	O	N	N	LMMM	N/A	LINK 2000+	ATN B1
MUAC Amsterdam FIR Brussels FIR Hannover FIR	O	O	N	EDYY	TBD	LINK 2000+	ATN B1 FANS 1/A

Control area (CTA)	CPDLC	ADS-C	FMC WPR	Logon address	ATSU ACARS Address	Coord Group	Remarks
Marseille UAC	O	N	N	LFMM	N/A	LINK 2000+	ATN B1
Milano ACC	O	N	N	LIMM	N/A	LINK 2000+	ATN B1
Nicosia FIR	O	N	N	LCCC	N/A	LINK 2000+	ATN B1
Oslo FIR	O	N	N	ENOS	N/A	LINK 2000+	ATN B1
Padova ACC	O	N	N	LIPP	N/A	LINK 2000+	ATN B1
Paris UAC	O	N	N	LFFF	N/A	LINK 2000+	ATN B1
Praha FIR	O	N	N	LKAA	N/A	LINK 2000+	ATN B1
Reims UAC	O	N	N	LFEE	N/A	LINK 2000+	ATN B1
Rhein UIR	O	N	N	EDMM	N/A	LINK 2000+	ATN B1
Riga UIR	O	N	N	EVRR	N/A	LINK 2000+	ATN B1
Roma FIR	O	N	N	LIRR	N/A	LINK 2000+	ATN B1
Scottish UIR	O	O	O	EGPX	TBD	LINK 2000+	ATN B1 FANS 1/A
Shannon UIR	O	O	O	EISN	TBD	LINK 2000+	ATN B1 FANS 1/A
Sofia FIR	O	N	N	LBSR	N/A	LINK 2000+	ATN B1
Sweden UIR	O	N	N	ESAA	N/A	LINK 2000+	ATN B1 Only in the area south of 61°30'N
Tallinn UIR	O	N	N	EETT	N/A	LINK 2000+	ATN B1
Vilnius UIR	O	N	N	EYVC	N/A	LINK 2000+	ATN B1
Warszaw FIR	O	N	N	EPWW	N/A	LINK 2000+	ATN B1

Control area (CTA)	CPDLC	ADS-C	FMC WPR	Logon address	ATSU ACARS Address	Coord Group	Remarks
Wien FIR	O	N	N	LOVV	N/A	LINK 2000+	ATN B1
Zurich UIR	O	N	N	LSAZ	N/A	LINK 2000+	ATN B1

E.4.1.1.4 [Table E-EUR- 2](#) lists the contact information of the EUR region and the website URL of the Central Reporting Office (CRO).

Table E-EUR- 2. Contact information and monitoring agency website URL

Coordinating group or regional monitoring agency	Contact information/website URL
EUROCONTROL LINK2000+	Soren Dissing Coordination Manager EUROCONTROL - Central Reporting Office (CRO) Tel: +3227293446 Email: soren.dissing@eurocontrol.int
EUROCONTROL Central Reporting Office (CRO)	http://www.eurocontrol.int/articles/central-reporting-office

E.4.1.2 EUR - NSAP address registry

E.4.1.2.1 In order to allow the air crew to perform a first LOGON with any of the participating ATN B1 ACCs, Context Management application addressing information of the ATS Units involved in the ATN/OSI based Air/Ground Data Link Communications, is required in the ATN avionics system.

E.4.1.2.2 The ATN NSAP addresses for all EUR Air Traffic Control Centres (ACCs) are published in EUR Doc 028 - EUR NSAP Address Registry – .

E.4.1.2.3 The focal point for the EUR NSAP Address Registry is the EUR/NAT ICAO Regional Office. All requests, modifications and proposals concerning this document should be forwarded to: <http://icaoearnat@paris.icao.int>.

Note 1.— The ICAO EUR/NAT Office ensures that the information is forwarded to the appropriate working groups (e.g. AFSG Planning Group).

Note 2.— The EUR NSAP Address Registry is available at the ICAO website: <http://www.paris.icao.int/documents/open/categories.php>

E.4.1.3 Flight plan provisions

E.4.1.3.1 In the EUR airspace where ATN B1 CPDLC is available and aircraft are equipped and capable ATN B1 CPDLC, J1 shall be included in Item 10a of the flight plan:

a) Operators of FANS 1/A – ATN B1 (independent or integrated) equipped aircraft shall insert one or more of the appropriate indicators among J1 –J7 in Item 10a.

b) For flights conducted wholly or partly in the EUR airspace where ATN B1 CPDLC is available but not equipped with CPDLC capabilities but which have been granted an exemption, the letter Z shall be included in Item 10A and the indicator DAT/CPDLCX shall be included in Item 18 of the flight plan.

E.4.1.3.2 For a flight operating based on a repetitive flight plan (RPL), during which the pilot intends to use CPDLC, a modification message (CHG) shall be submitted to indicate that the flight is capable of, and authorized for CPDLC, in accordance with [paragraph 3.3](#).

E.4.1.3.3 When there is a change to the CPDLC capability status for a flight planned to operate in the area specified in [Table E-EUR- 1](#), the operator should send a modification message (CHG) with the appropriate indications in the relevant items of the ICAO flight plan form, including any change to the aircraft address. A modification message for the day of operation should be sent not earlier than 20 hours before the estimated off-block time.

E.4.1.4 Logon criteria

E.4.1.4.1 In addition to the logon FPL correlation criteria, described in [paragraph 3.3](#), the CPDLC aircraft equipment capabilities in Item 10a are also used as criterion for a successful logon. Absence of item J1 and/or one or more of the items J2 to J7 in Item 10a will lead to a logon rejection.

E.4.1.5 Lack Timer

E.4.1.5.1 Logical Acknowledgement (LACK) messages (downlink message element [DM 100](#) and uplink message element [UM 227](#)) are used in ATN B1 based ACL and ACM message exchanges.

Note 1.— Ground systems do not request a LACK for the messages ERROR ([UM 159](#)), Service Unavailable ([UM 162](#)) and LACK ([UM 227](#)).

Note 2.— When a LACK is received after expiry of the LACK timer, the LACK may be discarded.

E.4.2 Controller procedures

E.4.2.1 Reverting from CPDLC to voice

E.4.2.1.1 The following circumstances describe potential situations where the controller should revert to voice to instruct the controller/pilot to ignore the CPDLC message:

a) When it is required to clarify the meaning or the intent of any unexpected, inappropriate or ambiguous CPDLC message;

b) Whenever it is deemed necessary to ensure the timely execution of a clearance or instruction previously issued by CPDLC.

c) Whenever corrective actions are required with respect to unintended clearances, instructions or information that has been sent using CPDLC.

E.4.2.1.2 Controllers should be aware that once a message is sent via CPDLC, no means exist to cancel or to recall that message.

Note.— In case of reversion to voice, controllers should be aware of the possibility that the CPDLC message they want the addressee to ignore may not be yet displayed to the addressee.

E.4.2.1.3 In that respect, the following actions should be taken by the addressee:

- a) If response to the referred CPDLC message was sent, cancel any action initiated on the basis of the initial CPDLC message and comply with the voice message;
- b) If the referred message is not responded to or not displayed, let the dialogue close on time-out. Since it may be possible to be asked to ignore a message that was not yet displayed, the controller/pilot should take all measures to ensure that the message is no longer valid.
- c) In case the controller/pilot has already received an operational response to the initial CPDLC message, he/she shall use appropriate voice phrases to stop/cancel the actions of the addressee.
- d) Whenever a system generates a time-out or an error for a CPDLC message.

E.4.2.1.4 *Use of Free Text.* In support of the recommendation in ED-110B/DO-280B on ‘free text’, some ANSPs don’t allow the controller to enter free text on the HMI.

E.4.2.2 Preconditions for the operational exchange of CPDLC messages

E.4.2.2.1 “When CPDLC is transferred, the transfer of voice communications and CPDLC shall commence concurrently” (Annex 10 V2, 8.2.9.6.1; PANS-ATM, 14.3.3.1).

E.4.2.2.2 The active connection status, as described in [paragraph 2.2.4.2](#), only allows for technical air-ground CPDLC exchanges between the aircraft and the ground system of the CDA.

E.4.2.2.3 The minimum condition required for an operationally functional 2-way communication connection, is that the aircraft is under the responsibility of the CDA (i.e. the ATSU has assumed the control of the flight after initial voice contact establishment and a CPDLC message, indicating the name and function of the current ATC unit, is received by the flight crew).

Note.— Additional local conditions (boundary proximity, etc.), which will vary from ATSU to ATSU, may apply.

E.4.2.2.4 If an aircraft sends a request to an ATSU before the minimum conditions have been fulfilled, the request is rejected by the ground system. An error message is displayed to the flight crew TRANSFER NOT COMPLETED REPEAT REQUEST.

E.4.2.3 Uplink messages

E.4.2.3.1 Operational use of LACK

E.4.2.3.1.1 Each time the controller uplinks an operational message, the ATN B1 aircraft system returns a [DM 100](#) logical acknowledgement (LACK).

E.4.2.3.1.2 The LACK timer value should be set by the ground system at 40 seconds.

E.4.2.3.1.3 If the ground system does not receive a LACK within 40 seconds, the controller will be notified.

Note 1.— The ground system does not request a LACK for messages [UM 159](#) (ERROR), [UM 162](#) (SERVICE UNAVAILABLE), [UM 227](#) (LACK).

Note 2.— Local implementers may decide whether the controller is notified on the receipt of each LACK (positive feedback) or is only notified upon a LACK time out (negative feedback).

Note 3.— When a LACK is received after expiry of the LACK timer, the LACK may be discarded.

E.4.2.3.2 UM 120 MONITOR [unitname] [frequency]

E.4.2.3.2.1 The UM 120 MONITOR message is not used for inter-ATSU and intra-ATSU flight transfers. This is because controllers want to have the assurance that voice communication is established at "initial call" to the next sector or ATSU. Moreover, the "initial call" is used to communicate cleared level and passing level, to reconfirm clearance previously given and to verify the accuracy of Mode-C at the first sector of the receiving ATSU.

E.4.2.3.2.2 In response to UM 120 MONITOR, sent by the transferring ATSU, DM 89 MONITORING is sent to the receiving ATSU which provides a confirmation message to the controller that the flight crew has switched to the instructed VHF frequency. It appears that in many aircraft, the uplinked frequency is not automatically loaded in the RMP and that the frequency and the ATSU's Facility designator in the 'DM 89 Monitoring' message are manually keyed in, making frequency switching more prone to errors.

E.4.2.3.2.3 As voice is the primary means of communications, controllers are not confident that silent transfers can be used.

E.4.2.3.3 ATC Microphone Check service (AMC)

E.4.2.3.3.1 The AMC service is achieved by the use of either of the following 2 Uplink messages:

- a) UM 157 CHECK STUCK MICROPHONE [frequency], or
- b) Free text UM 183 CHECK STUCK MICROPHONE

Note 1.— No flight crew acknowledgement of the instruction is required.

Note 2.— LACK is not used for AMC.

E.4.2.3.4 Uplink messages from a FANS 1/A – ATN B1 ATSU

E.4.2.3.4.1 A FANS 1/A – ATN B1 ATSU also provides CPDLC services to FANS 1/A aircraft. The following two procedures exist as mitigation against mis-delivered- and excessively delayed uplink message:

a) Misdelivery. For some of the FANS 1/A – ATN B1 ATSUs, the local safety assessment requires additional measures against the risk of misdelivery, when sending a CPDLC uplink message to a FANS 1/A aircraft. These ATSUs will automatically 'prepend' a free text message UM 169, containing the Flight Identification (FID), to each uplink message for verification by the flight crew (refer to E.3.3.1.1).

Note.— The mitigation measure is an identical mimic, when transmitting the clearance or instruction, using voice.

b) Delayed Uplink message, received by an aircraft. A FANS1/A –ATN B1 ATSU does not uplink message UM 169w SET MAX UPLINK DELAY VALUE TO [delayed message parameter] SECONDS to a FANS 1/A+ aircraft, instructing the flight crew to use the LTM function. Instead, the following procedure is used for FANS 1/A and FANS 1/A+ aircraft, when such aircraft receive an excessively delayed message. Upon expiry of ground-timer tts:

- 1) The ATSU should provide an indication to the controller, and,

- 2) The controller should return to voice and clarify the situation, and
- 3) Optionally, the controller may instruct the flight crew to terminate the CPDLC connection and logon to the next unit. The controller should use the following voice phraseology:

i) DISREGARD CPDLC [message type]. DISCONNECT CPDLC CONTINUE ON VOICE THEN LOGON TO [facility designation]

Note.— Upon its timeout, some FANS I/A- ATN ATSU's may automatically initiate a Provider Abort (commanded termination) message to the aircraft.

E.4.2.3.5 Concatenated uplink messages

E.4.2.3.5.1 ATSU's should only uplink a concatenated message containing maximum 2 clearances, instructions or report/information requests.

E.4.2.3.5.2 The use of concatenations of a message element with the 'W/U', A/N, R or Y response attribute and a message element with the 'Y' response attribute should be avoided.

E.4.2.3.5.3 Based on these principles, the use of concatenated messages should be limited to the following combinations:

- a) Level instruction concatenated with Speed instruction,
- b) Level instruction concatenated with Level Constraint,
 - 1) **UM 20** CLIMB TO [level] (resp. **UM 23** DESCEND TO [level]) clearance being incompatible with **UM 173** DESCEND AT [verticalRate] MINIMUM or **UM 174** DESCEND AT [verticalRate] MAXIMUM (resp. **UM 171** CLIMB AT [verticalRate] MINIMUM or **UM 172** CLIMB AT [verticalRate] MAXIMUM)
- c) Level instruction concatenated with Route modification instruction,
- d) Level instruction concatenated with Heading instruction,
- e) Route modification instruction concatenated with Speed instruction,
- f) Heading instruction concatenated with Speed instruction

Note.— most of these instructions added as suffixes of uplinked concatenated messages being optional. ANSPs will publish in aeronautical information publication the set of messages actually implemented.

E.4.2.3.6 Multiple open dialogues of CPDLC messages of the same type

E.4.2.3.6.1 In European Continental airspace, the controller should perform the exchange of CPDLC messages with only one open dialogue of the same type with the same aircraft at any given time.

Note.— Appropriate consideration should be given to system support procedures, so as to not allow the initiation of clearance dialogues with the same recipient, already involved in the same type of clearance dialogue.

Example 1: If a level instruction has been sent to an aircraft via CPDLC, a subsequent level instruction to the same aircraft can be initiated only if the CPDLC dialogue pertaining to the initial level instruction has been closed. If action is required before the dialogue is closed, the communications should be reverted to voice

Example 2: When the ground system receives a downlink request and there is an existing open uplink, containing the same type, the downlink request is discarded.

E.4.2.4 Operational timers used by ATSU

E.4.2.4.1 Controller initiated dialogue

E.4.2.4.1.1 When the controller uplinks a CPDLC message, requiring an operational response, the ground system starts the ground-timer (tts) which value is set at 120 seconds.

a) When this timer expires (i.e. non receipt of operational closure response within tts) the controller is notified and reverts to voice to resolve the situation (refer to paragraph [E.4.2.1](#) – Reverting from CPDLC to voice).

Note 1.— ATN B1 aircraft systems also have implemented an aircraft-timer (ttr), which is set at 100s. In normal circumstances, the aircraft-timer (ttr) expires before the ground-timer (tts) expires and consequently follows the procedure in [paragraph E.4.2.4.1](#).

Note 2.— FANS I/A aircraft do not have ttr timer.

b) The dialogue is closed locally by the ground system, ensuring that the dialogue doesn't remain open at the ground side.

E.4.2.4.1.2 If the flight crew responds to a clearance with a STANDBY, the aircraft and ground timers are re-started.

E.4.2.4.2 Flight crew initiated dialogue

E.4.2.4.2.1 When the ground system receives a request, then it starts the expiration timer-responder (ttr), which value is set at 250 seconds.

a) The timer-responder (ttr) expires, if the controller fails to respond within 250 seconds. The controller is notified and reverts to voice to complete the dialogue (Refer to paragraph [E.4.2.1](#) – Reverting from CPDLC to voice).

b) The ground system closes the dialogue and uplinks an error response 'ATC TIME OUT – REPEAT REQUEST'. The error response ensures that the dialogue will also be closed at the aircraft side.

Note.— Some ATN B1 aircraft systems also have implemented an aircraft-timer (tts), which is set at 270s. In normal circumstances, the ground-timer (ttr) expires before the aircraft-timer (tts) expires.

E.4.2.4.2.2 If the controller responds to a request with a STANDBY, the aircraft- and ground timer are re-started.

E.4.2.5 Transfer of data communications with open dialogues

E.4.2.5.1 Open ground-initiated dialogues

E.4.2.5.1.1 When a transfer of CPDLC results in a change of data authority and the transfer instruction has been initiated, but not yet sent, the controller transferring the CPDLC is informed of the open ground-initiated dialogues. The controller:

a) Waits for the responses to the open ground-initiated dialogues and then continues with the transfer instruction, or

b) Resolves the open ground initiated dialogues (via voice instructions) and then continues with the transfer instructions, or

c) Ignores the open ground initiated dialogues and continues with the transfer instruction.

Note.— *When open-ground initiated dialogues are ignored, the ground system closes all outstanding dialogues.*

E.4.2.5.1.2 When there are open ground-initiated dialogues, and the flight crew responds to the transfer instruction with a WILCO, the airborne system cancels all open ground initiated dialogues. When responding with UNABLE or STANDBY, the aircraft system maintains the open dialogues.

E.4.2.5.1.3 When a transfer of CPDLC does not result in a change of data authority and assuming that the T-sector is not the same as the R-sector, local procedures will define system behaviour, allowing ground systems to cancel or maintain all open ground-initiated dialogues. The airborne system maintains open ground-initiated dialogues.

E.4.2.6 Abnormal situations

E.4.2.6.1 Use of CPDLC in the event of voice radio communication failure

E.4.2.6.1.1 The existence of a CPDLC connection between the ATS unit and the aircraft should not pre-empt the pilot and ATC from applying all the ICAO provisions in the event of radio communication failure.

E.4.2.6.1.2 When the pilot cannot comply with the requirement above, he/she will have to apply the provisions stipulated for the event of radio communication failure.

E.4.2.6.2 Failure of logon forwarding procedure

E.4.2.6.2.1 The ground-ground forwarding (OLDI) procedure is used as default procedure for inter-ATSU flight transfers. In case of failure of the ground-ground forwarding (OLDI) procedure, or when this is temporarily not available, the transferring ATSU should automatically initiate a DLIC-contact request.

Note.— *No OLDI exchanges exist between ATSUs at the NAT boundary. DLIC-contact is used in this case.*

E.4.2.6.3 Controller commanded CPDLC termination

E.4.2.6.3.1 When the controller initiates termination, the ground system uplinks a free text message element ([UM 183](#)), containing the text “CONTROLLER TERMINATED CPDLC”, followed by a CPDLC-User–abort request.

E.4.2.6.3.2 To reinstate CPDLC after a controller initiated commanded termination, the controller initiates CPDLC on the HMI, triggering the ground system for a CPDLC-start request to the aircraft.

E.4.2.6.4 Suspension of CPDLC operations within a sector

E.4.2.6.4.1 Ground systems capable to provide CPDLC may allow the controller CPDLC to be turned “ON” and “OFF” on a sector basis as an additional protection to suspend CPDLC. When this is done on a sector basis, the CPDLC connection is maintained.

Note.— *Setting CPDLC “OFF/ON” is a local implementation issue.*

E.4.2.6.4.2 When the controller sets for his sector CPDLC to “OFF”, the ground system should send a free text message [UM 183](#) “NEXT SECTOR CPDLC NOT IN USE UNTIL NOTIFIED – USE VOICE”.

Note.— Setting CPDLC to “OFF” may be executed as an additional protection when the controller intends to suspend the use of CPDLC.

E.4.2.6.4.3 When the controller sets for his a sector CPDLC to “ON”, the ground system should send a free text message ([UM 183](#)) “CPDLC NOW IN USE”. After the generation of this message, the ground system should generate a free text message ([UM 183](#)), containing the text “CURRENT ATC UNIT [unitname]”

Note.— Setting CPDLC to “ON” may be executed in addition when the controller intends to resume the use of CPDLC.

E.4.2.7 Downlink error messages

E.4.2.7.1 ATN B1 systems use a number of operational errors, when uplinking an operational message. An operational error occurs when the ATN B1 ground system does not behave according to the ATN B1 requirements or local constraints prevent an operational response.

E.4.2.7.2 When receiving an ‘ERROR’ ([DM 62](#)) + free text message ([DM 98](#)) in response to operational uplink messages, the controller should revert to voice to clarify the situation with the flight crew.

E.4.2.7.3 [Table E-EUR- 3](#) provides a list of operational error messages displayed to the controller.

Table E-EUR- 3. Operational error downlink messages

Free Text message	Description	Procedure
AIRCREW HAS INHIBITED CPDLC	The aircraft is in CPDLC inhibited state and receives a CPDLC-start request from the ground. The aircraft reverts to the CPDLC inhibited state: 1. After the end of a flight, or 2. After a power cycle resulting in a cold start, or 3. When CPDLC is turned off by the pilot.	The controller should instruct the flight crew to initiate a CLM-logon request to leave the inhibited state.
MESSAGE DOES NOT CONTAIN THE POSITION TO BE NAVIGATED TO	The aircraft rejects UM 72 [RESUME OWN NAVIGATION] because UM 72 is not concatenated with UM 74 [PROCEED DIRECT TO [position], UM 79 CLEARED TO [position] VIA [routeClearance] or UM 80 CLEARED[routeClearance]. <i>Note.</i> — When uplinking UM 72 , ground systems are required to concatenate UM 72 with UM 74 , UM 79 or UM 80 , denoting the position to be navigated to.	The controller should resend UM 72 , concatenated with UM 74 , UM 79 or UM 80 .

Free Text message	Description	Procedure
THIS CONCATENATION NOT SUPPORTED BY THIS AIRCRAFT	The aircraft receives a concatenated uplink message that it does not support (invalid element combination, or at least one message element is not supported, or invalid element order). <i>Note.</i> — <i>Examples of obvious invalid combinations: Climb To + Descend To.</i>	The controller may resend the messages in the form of single messages, or use voice.
MESSAGE NOT SUPPORTED BY THIS AIRCRAFT	The aircraft receives an uplink message that it does not support. <i>Note.</i> — <i>All ATN B1 aircraft implementations support all uplink messages.</i>	The controller should revert to voice.
FREE TEXT MESSAGE TOO LARGE	The aircraft receives an uplink free text message element containing more than 80 characters, and the aircraft system cannot support the number of characters in a free text message element.	The controller should revert to voice. <i>Note.</i> — <i>For use of free text, see also paragraph 4.3.2.</i>
UNACCEPTABLE DATA COMBINATION IN ROUTE CLEARANCE	The aircraft receives UM 79 CLEARED TO [position] VIA [route clearance] or UM 80 CLEARED [route clearance], for which the [ATS route designator] parameter is not followed by a [published identifier] parameter or an [ATS route designator] parameter.	The controller should resend UM 79 or UM 80 with the appropriate parameters.
CPDLC TRANSFER NOT COMPLETED – REPEAT REQUEST	Until CPDLC is enabled, the ground system rejects any downlink message; except DM99 (CURRENT DATA AUTHORITY), DM89 (MONITORING), DM62 (ERROR), and DM62 concatenated with DM98 (ERROR + Free text).	The flight crew cannot use data link now, but when CPDLC is fully operational, a CPDLC message is uplinked and displayed to the flight crew, indicating the name and function of the current ATC unit. The flight crew should not attempt to repeat the request until the CPDLC transfer has been completed and they are under the control of the ACC, being the CDA.

Free Text message	Description	Procedure
AIRSYSTEM TIME-OUT	The flight crew receives an instruction/clearance, but fails to respond within 100s at time of reception. The aircraft-timer ttr expires and automatically downlinks the error message. The aircraft system closes the dialogue. Up on receipt of the error message, the ground systems closes the dialogue.	The controller should revert to voice.
UPLINK DELAYED IN NETWORK AND REJECTED. RESEND OR CONTACT BY VOICE	The aircraft rejects a message, because the difference between the timestamp of sending by ground and aircraft reception time is more than 40 seconds.	The controller should revert to voice or may resend the message by CPDLC.
DOWNLINK TIMESTAMP INDICATES FUTURE TIME.	The aircraft receives a message timestamp that indicates a future time greater than 2 seconds from the current time.	The controller should revert to voice.

E.4.3 Flight crew procedures

E.4.3.1 General

E.4.3.1.1 Reception of uplink messages received by FANS 1/A aircraft

E.4.3.1.1.1 Some of the FANS 1/A – ATN B1 ATSU's 'prepend' a free text message [UM 169](#), containing the FID, to each uplink message, sent to a FANS 1/A aircraft. (Refer to [paragraph E.4.2.3.4 a](#) - Misdelivery)

E.4.3.1.1.2 Flight crew should verify that the 'prepended' FID matches with the aircraft's FID as filed in the flight plan, item 7a.

E.4.3.1.1.3 In case the FID doesn't match, the flight crew should reject the uplinked message, revert to voice communications to notify the ATSU of the misdelivered message.

E.4.3.1.2 Reverting from CPDLC to voice

E.4.3.1.2.1 The following circumstances describe potential situations where the flight crew communications should revert to voice:

- a) When it is required to clarify the meaning or the intent of any unexpected, inappropriate or ambiguous CPDLC message;
- b) Whenever corrective actions are required with respect to unintended or spurious request that have been sent using CPDLC. The flight crew should be aware that once a message is sent via CPDLC,

no means exist to cancel or to recall that message. The following actions should be taken by the flight crew after the controller has reverted to voice:

- 1) If response to the referred CPDLC message was sent, cancel any action initiated on the basis of the initial CPDLC message and comply with the voice message;
- 2) If the referred message is not responded to or not displayed, let the dialogue close on time-out. Since it may be possible to be asked to ignore a message that was not yet displayed, the flight crew should take all measures to ensure that the message is no longer valid.
- 3) In case the flight crew has already received an operational response to the initial CPDLC message, he/she shall use appropriate voice phrases to stop/cancel the actions of the addressee; and

Note.— In case of reversion to voice, flight crew should be aware of the possibility that the CPDLC message they want the addressee to ignore may not be yet displayed to the addressee.

- c) Whenever a system generates a time-out or an error for a CPDLC message.

E.4.3.1.3 Use of concatenated messages - air initiated

E.4.3.1.3.1 Aircraft and ground systems should allow for a downlink concatenated message containing a maximum of two message elements.

E.4.3.1.3.2 The only downlink concatenated messages, which ground systems are required to support, are those that result from a concatenation of one message element from the left column and one message element from the right column.

First message element in message	Second message element in message
<u>DM 6</u> REQUEST [level]	<u>DM 65</u> DUE TO WEATHER
<u>DM 9</u> REQUEST CLIMB TO [level]	<u>DM 66</u> DUE TO AIRCRAFT PERFORMANCE
<u>DM 10</u> REQUEST DESCENT TO [level]	
<u>DM 22</u> REQUEST DIRECT TO [position]	

E.4.3.1.4 Responding to concatenated message elements with response attribute other than Y

E.4.3.1.4.1 The permitted response will be messages containing one of the following message elements: DM 100 LOGICAL ACKNOWLEDGMENT (if required), DM 2 STANDBY, DM 0 WILCO, DM 1 UNABLE, DM 63 NOT CURRENT DATA AUTHORITY, DM 107 NOT AUTHORIZED NEXT DATA AUTHORITY or DM 62 ERROR message element.

E.4.3.1.4.2 The closure response message will be a message containing one of the following message elements: DM 0 WILCO, DM 1 UNABLE, DM 63 NOT CURRENT DATA AUTHORITY, DM 107 NOT AUTHORIZED NEXT DATA AUTHORITY or DM 62 ERROR message element.

E.4.3.1.4.3 The DM 0 WILCO or DM 1 UNABLE response messages will operationally apply to the entire uplink concatenated message – see [paragraph 5.3.1.3](#) and [paragraph 5.3.1.4](#).

E.4.3.1.4.4 As responses to a ground initiated dialogue, ground systems are required to also support the following downlink concatenated messages:

First message element in message	Second message element in message
<u>DM 1</u> UNABLE	<u>DM 65</u> DUE TO WEATHER
<u>DM 82</u> WE CANNOT ACCEPT [level]	<u>DM 66</u> DUE TO AIRCRAFT PERFORMANCE

E.4.3.2 Latency time monitor (LTM)

E.4.3.2.1 In accordance with safety requirement SR-ACL-13 of ED120/DO290, the message latency monitor defined in ED100A/DO258A, paragraph 4.6.6.9, and ED110B/DO280B (ATN), paragraph 3.3.4, provides to the ANSP a means to mitigate the effects of an excessively delayed CPDLC message. In Europe, this message latency monitor is referred to as the Latency Time Monitor (LTM).

Note.— *The LTM function is not used by FANS I/A+ aircraft (Refer to [para E.4.2.3.4 b](#)) – Delayed uplink message, for alternative procedure).*

E.4.3.2.2 An ATN B1 compliant aircraft has a Latency Time Monitor (LTM) function in the form of a hard-coded LTM value in the avionics. The LTM value is set at 40 seconds.

E.4.3.2.3 Upon activation of LTM, the aircraft system will:

a) Display the message to the flight crew with a delayed message indication. The flight crew should contact the controller and advise him/her of the situation and/or request verification of ATC intent; or

b) Discard the message without any indication to the flight crew and notify the controller with a message consisting of DM 62 ERROR [error information] and DM 98 [UPLINK DELAYED IN NETWORK AND REJECTED. RESEND OR CONTACT BY VOICE]. The controller should revert to voice to clarify the situation.

Note.— *Refer to [Appendix F, paragraph F.11](#) for the specifications on the LTM function implemented in different aircraft types.*

E.4.3.3 Operational use of LACK

E.4.3.3.1 Each time the flight crew downlinks an operational message, the ATN B1 ground system returns a UM 227 logical acknowledgement (LACK).

E.4.3.3.2 The LACK timer value should be set by the aircraft system at 40 seconds.

E.4.3.3.3 If the aircraft system does not receive a UM 227 LACK within 40 seconds, the flight crew will be notified.

Note 1.— *The aircraft system does not request a UM 227 LACK for messages DM 62 (ERROR), DM 63 NOT CURRENT DATA AUTHORITY), DM 100 (LACK) and DM 107 (NOT AUTHORIZED NEXT DATA AUTHORITY).*

Note 2.— *Local implementers may decide whether the flight crew is notified on the receipt of each LACK (positive feedback) or is only notified upon a LACK time out (negative feedback).*

Note 3.— *When a UM 227 LACK is received after expiry of the LACK timer, the UM 227 LACK may be discarded.*

E.4.3.4 Operational timers used by the aircraft

E.4.3.4.1 Controller initiated dialogue

E.4.3.4.1.1 When an ATN B1 aircraft system receives an uplink message, requiring a response, it starts the expiration timer-responder (ttr), which value for the response to be sent is set at 100 seconds.

a) The timer-responder (ttr) expires if the flight crew fails to respond within 100 seconds. The flight crew is notified and reverts to voice to complete the dialogue;

Note.— FANS I/A aircraft do not have a ttr timer.

b) The ATN B1 aircraft system closes the dialogue and downlinks an error response ‘AIRSYSTEM TIME-OUT’. The error response ensures that the dialogue will also be closed within the ATSU.

Note.— In normal circumstances, the aircraft-timer (ttr) expires before the ground-timer (tts) expires.

E.4.3.4.1.2 If the flight crew responds to a clearance with a **DM 2** STANDBY, the aircraft- and ground timers are re-started.

E.4.3.4.2 Flight crew initiated dialogue

E.4.3.4.2.1 When the flight crew downlinks a request, requiring an operational response, and when implemented, the ATN B1 aircraft system starts the expiration timer-initiator (tts). If used, the timer value for the operational response to be received is set at 270 seconds.

a) The timer-initiator (tts) expires, if no operational response has been received by the aircraft system within 270 seconds. The flight crew is notified and reverts to voice to resolve the situation.

b) The dialogue is closed locally by the aircraft system, ensuring that the dialogue doesn’t remain open at the aircraft side.

Note.— ATN B1 ground systems have implemented ground-timer. In normal circumstances, the ground-timer (ttr) expires before the aircraft-timer (tts) expires. Refer to [paragraph E.4.2.4.2](#).

E.4.3.4.2.2 If the controller responds to a request with a **UM 1** STANDBY, the aircraft and ground timers are re-started.

E.4.3.5 Use of degrees in ACL messages

E.4.3.5.1 The Display of [degrees] parameter is used in the following three CPDLC messages:

a) **UM 94** TURN (direction) HEADING (degrees)

b) **UM 190** FLY HEADING (degrees)

c) **UM 215** TURN (direction) (degrees) DEGREES

E.4.3.5.2 **UM 94** and **UM 190** represent an absolute change towards the instructed HEADING, while **UM 215** is a relative change with reference to the current HEADING.

E.4.3.5.3 ICAO requires that the HEADING in **UM 94** and **UM 190** is expressed in 3 digits (e.g. ‘015°’) and should be displayed accordingly.

E.4.3.5.4 Flight crews should be aware that Airframe and avionics manufacturers are adding a leading ‘0’ for degrees less than 100° for **UM 94** and **UM 190**.

E.4.3.5.5 However, **UM 215** is expressed in two digits (e.g. 15 degrees). To ensure that flight crews execute **UM 215** as a relative change, **UM 215** is displayed as TURN (direction) (degrees) DEGREES (e.g. TURN RIGHT 15 DEGREES).

E.4.3.6 Transfer of data communications with open dialogues

E.4.3.6.1 Open air-initiated dialogues

E.4.3.6.1.1 When there are open air-initiated dialogues, the ground system closes each of these dialogues with a closure response before sending the transfer instruction. The closure uplink responses are one of the following:

- a) UNABLE (**UM 0**), or
- b) REQUEST AGAIN WITH NEXT UNIT (**UM 237**), or
- c) Concatenated message 'ERROR' (**UM 159**) + REQUEST AGAIN WITH NEXT UNIT (**UM 183** - free text), or
- d) REQUEST AGAIN WITH NEXT UNIT (**UM 183** - free text)

E.4.3.6.1.2 When there are open air-initiated dialogues, and the flight crew responds to the transfer instruction with a **DM 0** WILCO, the airborne system cancels all open air initiated dialogues. When responding with **DM 1** UNABLE or **DM 2** STANDBY, the aircraft system maintains the open dialogues.

E.4.3.7 Multiple open requests for a same type

E.4.3.7.1 To avoid ambiguity and request being discarded by the ATSU, the flight crew should avoid sending multiple requests for a same type of dialogue, dialogue type being one of the following: a) level; b) heading; c) speed; d) route.

Note.— The flight crew should be aware that only one downlink request for a single type will be presented to the controller and that this open dialogue must be closed before a second request of that type may be treated.

E.4.3.8 Abnormal situations

E.4.3.8.1 Inability to contact the assigned voice communication channel

E.4.3.8.1.1 When the flight crew is unable to contact the assigned voice communication channel when instructed to do so by the transferring controller via CPDLC, the flight crew should revert to the voice communication channel of the transferring ATC unit for instructions.

E.4.3.8.2 Use of CPDLC in the event of voice radio communication failure

E.4.3.8.2.1 The existence of a CPDLC connection between the ATS unit and the aircraft should not pre-empt the flight crew and ACC from applying all the ICAO provisions in the event of radio communication failure.

E.4.3.8.2.2 When the flight crew cannot comply with the requirement above, he/she will have to apply the provisions stipulated for the event of radio communication failure.

E.4.3.8.3 Flight crew commanded CPDLC termination

E.4.3.8.3.1 When flight crew initiates CPDLC termination, the ATN B1 airborne system sends a CPDLC-User-abort to the ground system. The controller is notified of the abort.

Note.— Subject to local designs, ground systems may not provide facilities for CPDLC connect request to be re-issued upon notification by the flight crew that they want to resume CPDLC with the ground.

E.4.3.8.3.2 To reinstate CPDLC after a flight crew initiated commanded termination, the flight crew initiates a CM-logon request.

E.4.3.9 Uplink error messages

E.4.3.9.1 ATN B1 systems use a number of operational errors, when downlinking an operational message. An operational error occurs when the ATN B1 ground system does not behave according to the ATN B1 requirements or local constraints prevent an operational response.

E.4.3.9.2 When receiving an ‘ERROR’ (UM 159) + free text message (UM 183) in response to operational downlink messages, the flight crew should revert to voice to clarify the situation with the controller.

E.4.3.9.3 Table E-EUR- 4 provides a list of operational error messages displayed to the flight crew.

Table E-EUR- 4. Operational error uplink messages

Free Text message	Description	Procedure
DOWNLINK MESSAGE REQUEST REJECTED - SEND (number) ELEMENTS	The ground system receives a message that contains more message elements than it can support in a message. Example: The flight crew sends a combined message (DM 6 REQUEST [level], DM 70 REQUEST HEADING [degrees], DM 65 DUE TO WEATHER) and the ground system accepts only a maximum of two message elements. <i>Note.</i> — It is a local choice of the ground system to reject downlink messages containing more than 1, 2 or 3 message elements or to accept up to 5 message elements.	The flight crew may resend the request in the form of separate messages, or make the request/s by voice.
(Dialogue type) NOT AVAILABLE AT THIS TIME – USE VOICE Dialogue type is one of the following: LEVEL, HEADING, SPEED, ROUTE REQUEST	The ground system receives a downlink message that is discarded because the associated dialogue type is disabled.	The flight crew should make the request by voice.

Free Text message	Description	Procedure
ELEMENT COMBINATION REJECTED – USE VOICE	<p>The ground system receives a concatenated downlink message that it does not support (invalid element combination, or at least one message element is not supported, or invalid element order).</p> <p><i>Note.</i>— <i>Whether a combination of message elements is valid or not, is determined through local choice of the ground system.</i></p> <p><i>Examples of obvious invalid combinations: Request Climb To + Request Descend To; WILCO + UNABLE, etc.</i></p>	<p>The flight crew may resend the message/request in the form of separate messages, or make the request/s by voice</p>
<p>TOO MANY (dialogue type) REQUESTS – EXPECT ONLY ONE REPLY</p> <p>Dialogue type is one of the following: LEVEL, HEADING, SPEED, ROUTE.</p>	<p>The ground system receives a downlink request, and there is an existing open downlink request containing the same type and it discards the second request.</p>	<p>The flight crew should be aware that only one downlink request for a single type will be presented to the controller, and that this open dialogue must be closed before a second request of that type may be treated.</p>
<p>REQUEST REJECTED – REPLY TO (dialogue type) UPLINK FIRST</p> <p>Dialogue type is one of the following: LEVEL, HEADING, SPEED, ROUTE.</p>	<p>The ground system receives a downlink request, and there is an existing open uplink containing the same type. The downlink request is discarded.</p> <p><i>Note.</i>— <i>Ground systems only accept one data link exchange of a given type at the same moment.</i></p>	<p>The flight crew must respond to the uplink before being able to send a downlink request of this type.</p>
<p>TOO MANY CPDLC REQUESTS - USE VOICE</p>	<p>The ground system receives a downlink request, and discards a message because the maximum number of open operational dialogues with the aircraft is exceeded and there is no pending uplink message.</p> <p><i>Note.</i>— <i>The total number of data link exchanges with an aircraft may be limited by some ground systems. This means that further requests will be rejected.</i></p>	<p>The flight crew should make the request/s by voice.</p> <p>If there are only downlink requests, the flight crew cannot do anything about it.</p> <p>If there is at least one uplink expecting a response, the flight crew can respond to that clearance first to enable reception of a downlink request.</p>

Free Text message	Description	Procedure
CPDLC TRANSFER NOT COMPLETED – REPEAT REQUEST	Until CPDLC is enabled, the ground system rejects any downlink message; except <u>DM 99</u> (CURRENT DATA AUTHORITY), <u>DM 89</u> (MONITORING), <u>DM 62</u> (ERROR), and <u>DM 62</u> concatenated with <u>DM 98</u> (ERROR + Free text).	The flight crew cannot use data link now, but when CPDLC is fully operational, a CPDLC message is uplinked and displayed to the flight crew, indicating the name and function of the current ATC unit. The flight crew should not attempt to repeat the request until the CPDLC transfer has been completed and they are under the control of the ACC, being the CDA.
ATC TIME OUT – REPEAT REQUEST	If the controller fails to respond within 250 seconds the timer-responder (ttr) expires. The ground system closes the dialogue and automatically uplinks an error message in response to the downlink message request.	The flight crew is notified that the controller has not responded in the due time. The flight crew should repeat the request/s by voice
DOWNLINK DELAYED – USE VOICE.	The ground system receives a message and discards the message because it contains a timestamp that is older than the allowed limit.	The flight crew should revert to voice.
DOWNLINK DELAYED-USE VOICE'	Upon activation of the latency time monitor, the ground system automatically uplinks an error message. <i>Note.— The use of the LTM function for the ATSU is a recommendation.</i>	The flight crew should revert to voice.
DOWNLINK TIMESTAMP INDICATES FUTURE TIME.	The ground system receives a message timestamp that indicates a future time greater than 2 seconds from the current time.	The flight crew should revert to voice.
MESSAGE NOT SUPPORTED BY THIS ATS UNIT	The ground system receives a downlink message that it does not support, whether or not the message contains a message reference number, and discards the received message.	The flight crew should revert to voice.

Free Text message	Description	Procedure
FREE TEXT MESSAGE TOO LARGE - USE VOICE.	The ground system receives a downlink free text message element containing more than 80 characters, and the system cannot support the number of characters in a free text message element, and discard the received message.	The flight crew should revert to voice. <i>Note.— Ground systems may not accept downlink free text messages, or may not display them to the controller.</i>
CPDLC MESSAGE FAILED - USE VOICE.	A CPDLC downlink message is received that results in an error that is not already covered in the ATN SARPs, and the ground system discards the message.	The flight crew should revert to voice.
INVALID USE OF FREE TEXT MESSAGE - CONTACT ATC	The ground system does not support a message containing a free text message element because the message does not also contain the DM 62 ERROR (error information) message element and discards the message.	The flight crew should revert to voice.
RADAR TRACKING TERMINATED - TERMINATING CPDLC.	The ground system decides to terminate a CPDLC connection with an aircraft because it has lost radar data.	The flight crew should revert to voice.
CPDLC FOR (dialogue type) FAILED - USE VOICE. Dialogue type is one of the following: LEVEL, HEADING, SPEED, ROUTE	The ground system receives a downlink message containing a dialogue type that it does not support and discards the message.	The flight crew should revert to voice.
MESSAGE DOES NOT CONTAIN FACILITY NAME.	The ground system receives a downlink message that contains the unitname data type, but rejects the message because it does not also contain the facilityname data type and discards the message.	The flight crew should revert to voice.

E.4.4 Advanced data link operations

NIL

E.4.5 State aircraft data link operation

NIL

E.5 Middle East/Asia (MID/ASIA) Region

E.5.1 Administrative provisions related to data link operations

Table E-MID/ASIA- 1. Data link services by control area (CTA)

Control area (CTA)	CPDLC	ADS-C	FMC WPR	AFN address	ATSU ACARS Address	Coord Group	Remarks
Bahrain							
Emirates							
Ho Chi Minh				VVTS			
Kuala Lumpur				WMFC			
Kuwait							

E.5.2 Controller and radio operator procedures

NIL

E.5.3 Flight crew procedures

NIL

E.5.4 Advanced data link operations

NIL

E.5.5 State aircraft data link operation

NIL

E.6 North-America (NAM) Region

E.6.1 Administrative provisions related to data link operations

Table E-NAM- 1. Data link services by control area (CTA)

Control area (CTA)	CPDLC	ADS-C	FMC WPR	AFN address	ATSU ACARS Address	Coord Group	Remarks
Edmonton (Canada)	O	O	N	CZEG	YEGE2YA for CPDLC and YEGCDYA for ADS-C	NAT CNSG	
Gander domestic	O	N	N	CDQX	YQXD2YA	NAT CNSG	
Montreal domestic	O	N	N	CZUL	YULE2YA	NAT CNSG	
Vancouver Domestic	O	N	N	CZVR	YVRE2YA	NAT CNSG	
Winnipeg Domestic	O	N	N	CZWG	YWGE2YA	NAT CNSG	
Moncton Domestic	O	N	N	CZQM	YQME2YA	NAT CNSG	
Albuquerque	N	N	N				
Anchorage and Anchorage Arctic	O	N	N	PAZA	ANCXFXA	IPACG FIT	CPDLC voice transfer: CONTACT PAZA CENTER [frequency] Confirm CPDLC CDA: One CPDLC position report at FIR boundary.
Anchorage continentalOceanic (south of N63 and west of W165)	O	O	N	PAZN	ANCATYA	IPACG FIT	CPDLC voice transfer: CONTACT PAZA CENTER [frequency] Confirm CPDLC CDA: One CPDLC position report at FIR boundary.
Atlanta	N	N	N				
Boston	N	N	N				
Chicago	N	N	N				
Cleveland	N	N	N				
Denver	N	N	N				
Ft. Worth	N	N	N				
Houston	N	N	N				
Indianapolis	N	N	N				

Control area (CTA)	CPDLC	ADS-C	FMC WPR	AFN address	ATSU ACARS Address	Coord Group	Remarks
Jacksonville	N	N	N				
Kansas City	N	N	N				
Los Angeles	N	N	N				
Memphis	N	N	N				
Miami	N	N	N				
Minneapolis	N	N	N				
New York	O	O	N	KZWY	NYCODYA	NAT CNSG	DO NOT use CPDLC for position reporting. Use ADS-C or voice only. SELCAL check via HF are required for all FANS connected aircraft prior to entering the CTA/FIR. DO NOT send a CPDLC position report to confirm CDA prior to, or upon crossing the FIR.
Oakland	O	O	N	KZAK	OAKODYA	IPACG FIT ISPACG FIT	CPDLC voice transfer: CONTACT KSFO CENTER [frequency] KSFO (San Francisco Radio) will provide all primary and secondary HF frequencies, and HF transfer points along the route of flight. Confirm CPDLC CDA: One CPDLC position report at FIR boundary.
Salt Lake	N	N	N				
Seattle	N	N	N				
Washington	N	N	N				

Note.— Also see the NAT part for additional information.

E.6.2 Controller and radio operator procedures

NIL

GOLD

Second Edition — 26 April 2013

E.6.3 Flight crew procedures

NIL

E.6.4 Advanced data link operations

NIL

E.6.5 State aircraft data link operation

NIL

E.7 North Atlantic (NAT) Region**E.7.1 Administrative provisions related to data link operations****E.7.1.1 ANSP service provision**

E.7.1.1.1 [Table E-NAT- 1](#) lists the flight information regions (FIRs) and Upper flight information regions (UIRs), where data link service is provided and indicates Logon address, ATSU ACARS Address, coordinating group, CPDLC Contact or Monitor message requirements and position reporting requirements. For CPDLC, ADS-C and FMC WPR columns, O=operational, T=trial, and N=not available.

E.7.1.1.2 [Table E-NAT- 2](#) lists the contact information of the NAT CSNG and [Table E-NAT- 3](#) provides the website URL of the CRA.

Table E-NAT- 1. Data link services by control area (CTA).

Control area (CTA)	CPDLC	ADS-C	FMC WPR	AFN address	ATSU ACARS Address	Coord Group	Remarks
Bodø	N	O	O	ENOB		NAT CNSG	
Edmonton (Canada)	O	O	N	CZEG	YEGE2YA for CPDLC and YEGCDYA for ADS-C	NAT CNSG	
Gander Oceanic	O	O	O	CZQX	YQXE2YA	NAT CNSG	Report revised ETA: Next waypoint ETA error 3 minutes or more, use free text DM 67k REVISED ETA [position] [time]. See paragraph E.7.1.4 .

Control area (CTA)	CPDLC	ADS-C	FMC WPR	AFN address	ATSU ACARS Address	Coord Group	Remarks
Gander domestic	O	N	N	CDQX	YQXD2YA	NAT CNSG	
Montreal domestic	O	N	N	CZUL	YULE2YA	NAT CNSG	
Moncton Domestic	O	N	N	CZQM	YQME2YA	NAT CNSG	
New York	O	O	N	KZWY	NYCODYA	NAT CNSG	<p>DO NOT use CPDLC for position reporting. Use ADS-C or voice only.</p> <p>SELCAL check via HF is required for all FANS connected aircraft prior to entering the New York CTA.</p> <p>DO NOT send a CPDLC position report to confirm CDA prior to, or upon crossing the New York CTA.</p>
Reykjavik	O	O	O	BIRD	REKCA YA	NAT CNSG	<p>Confirm CPDLC CDA: Free text uplink message.</p> <p>Report revised ETA: Next waypoint ETA error 3 minutes or more, use free text DM 67k REVISED ETA [position] [time]. See paragraph E.7.1.4.</p>
Santa Maria	O	O	O	LPPO	SMACAYA	NAT CNSG	<p>Confirm CPDLC CDA: CPDLC UM 160 (NDA).</p> <p>Report revised ETA: Next waypoint ETA error 3 minutes or more, use free text DM 67k REVISED ETA [position] [time]. See paragraph E.7.1.4.</p>

Control area (CTA)	CPDLC	ADS-C	FMC WPR	AFN address	ATSU ACARS Address	Coord Group	Remarks
Shanwick	O	O	O	EGGX	PIKCPYA	NAT CNSG	Report revised ETA: Next waypoint ETA error 3 minutes or more, use free text <u>DM 67k</u> REVISED ETA [position] [time]. See <u>paragraph E.7.1.4</u> . Respond with immediate STANDBY to acknowledge receipt of downlink message.
Vancouver Domestic	O	N	N	CZVR	YVRE2YA	NAT CNSG	
Winnipeg Domestic	O	N	N	CZWG	YWGE2YA	NAT CNSG	

Table E-NAT- 2. Contact information

Coordinating group or regional monitoring agency	Contact information
NAT CNSG ICAO	Elkhan Nahmadov Phone +33 1 4641 8529 Fax +33 1 4641 8500 Email icaoearnat@paris.icao.int
NAT CNSG Operations	Shelley Bailey Operational System Requirements Phone +1-709-651-5240 Fax +1(709) 651 5235 Email bailesh@navcanada.ca Pedro Vicente Operational System Requirements – Domestic Phone +1(613) 248 -6965 Email vicentpe@navcanada.ca
NAT CNSG Engineering	Tim Murphy Team Leader, Engineering Operations Support Phone +44 1292 692 772 Fax +44 1292 692 640 Email: tim.murphy@nats.co.uk

Coordinating group or regional monitoring agency	Contact information
NAT CNSG Operators using ARINC as their CSP contact	Pete Grogan Phone (410) 266-2344 Email PGROGAN@arinc.com
NAT CNSG Operators using SITA as their CSP contact	Kathleen Kearns Manager, AIRCOM ATC Business, North America Phone: (703) 491-0661 Fax: (703) 491-0662 e-Mail: Kathleen.Kearns@sita.aero

Table E-NAT- 3. Regional monitoring agency websites available for problem reporting

Regional monitoring agency	Website URL
NAT Data Link Monitoring Agency (NAT DLMA) co-managed with the Informal South Pacific ATC Coordinating Group (ISPACG) and ISPACG Central Reporting Agency (CRA) and CRASA	http://www.ispacg-cra.com/

E.7.1.2 Uplink message elements unsuited for NAT operations

E.7.1.2.1 The following uplink message elements are unsuited for NAT operations and NAT ANSPs should avoid their use:

- a) **UM 171** CLIMB AT [vertical rate] MINIMUM
- b) **UM 172** CLIMB AT [vertical rate] MAXIMUM
- c) **UM 173** DESCEND AT [vertical rate] MINIMUM
- d) **UM 174** DESCEND AT [vertical rate] MAXIMUM
- e) **UM 115** DO NOT EXCEED [speed]
- f) **UM 116** RESUME NORMAL SPEED
- g) **UM 146** REPORT GROUND TRACK
- h) **UM 182** CONFIRM ATIS CODE

E.7.1.3 Unsupported CPDLC downlink message elements – NAT

E.7.1.3.1 This paragraph provides the CPDLC downlink message elements that are supported by a data link system but are not supported within a specific region. If the appropriate ATSU receives any of the message elements listed in **Table E-NAT- 4**, they will send **UM 169u** MESSAGE NOT SUPPORTED BY THIS ATS UNIT.

Note.— See [Appendix A](#) for CPDLC message elements that are supported by a data link system but their use should be avoided due to potential misinterpretation and should not be supported globally.

Table E-NAT- 4. Unsupported CPDLC downlink message elements

Data link system	Unsupported downlink message elements
FANS 1/A	<p>DM 49 WHEN CAN WE EXPECT [speed] DM 50 WHEN CAN WE EXPECT [speed] TO [speed] DM 51 WHEN CAN WE EXPECT BACK ON ROUTE DM 52 WHEN CAN WE EXPECT LOWER ALTITUDE DM 53 WHEN CAN WE EXPECT HIGHER ALTITUDE DM 54 WHEN CAN WE EXPECT CRUISE CLIMB TO [altitude] DM 67h WHEN CAN WE EXPECT CLIMB TO [altitude] DM 67i WHEN CAN WE EXPECT DESCENT TO [altitude]</p> <p><i>Note.</i>— The downlink messages are not supported because of potential misinterpretation of appropriate uplink responses in the event of a total communication failure. In addition to highlighted messages in Appendix A, the following uplink messages are not used in the NAT:</p> <p>UM 70 EXPECT BACK ON ROUTE BY [position] UM 71 EXPECT BACK ON ROUTE BY [time] UM 99 EXPECT [procedure name] UM 100 AT [time] EXPECT [speed] UM 101 AT [position] EXPECT [speed]</p>

E.7.1.4 Reporting requirements in NAT airspace where ADS-C is available

E.7.1.4.1 In the NAT Region, if the estimated time for the next position last provided to air traffic control is found to be in error by three minutes or more, the flight crew should provide a revised estimated time.

E.7.1.4.2 The flight crew may assume that the estimate for the next waypoint, shown on the FMS at the time a waypoint is crossed, is the estimate transmitted to ATC.

E.7.1.4.3 The flight crew should provide the revised estimate to the controlling ATS unit as soon as possible via voice or CPDLC using free text [DM 67k](#) REVISED ETA [position] [time].

E.7.2 Controller and radio operator procedures

E.7.2.1 Voice communication procedures

E.7.2.1.1 Aeradio - response to initial contact

E.7.2.1.1.1 Aeradio operators should:

a) Respond to an aircraft that identifies itself by including a data link term after the aircraft call sign by restating the data link term after the aircraft call sign (see [paragraph E.7.3.1.1.3](#) for the list of data link terms); and

b) Complete the SELCAL check (see [paragraph E.7.3.1.1.4](#) and [paragraph E.7.3.1.1.5](#) for examples of the initial contact procedures to be used by the flight crew).

E.7.2.1.1.2 If a flight uses the term “A-D-S” after the aircraft call sign, the aeradio operator should issue:

a) Communication instruction for the next CTA/FIR; or

b) Communications instructions and the frequency to contact the appropriate ATSU approaching, or over, the exit point; or

c) Instructions for the flight to contact the aeradio station serving the next CTA/FIR at a time or location prior to the next CTA/FIR boundary or exit point.

E.7.2.1.1.3 When the CTA/FIR does not offer FMC WPR services, if a flight uses the term “F-M-C” after the aircraft call sign, the aeradio operator should advise the flight crew to make position reports by HF voice.

E.7.2.1.1.4 When the CTA/FIR offers FMC WPR services, if a flight uses the term “F-M-C” after the aircraft call sign, the aeradio operator should issue:

a) Communication instruction for the next CTA/FIR; or

b) Communications instructions and the frequency to contact the appropriate ATSU approaching, or over, the exit point; or

c) Instructions for the flight to contact the aeradio station serving the next CTA/FIR at a time or location prior to the next CTA/FIR boundary or exit point.

E.7.2.1.1.5 When the CTA/FIR does not offer CPDLC services, if a flight uses the term “C-P-D-L-C” after the aircraft call sign, the aeradio operator should:

a) Advise the flight that ““CPDLC SERVICE NOT AVAILABLE IN (name) CTA/FIR”; and

b) Issue:

1) Communication instruction for the next CTA/FIR; or

2) Communications instructions and the frequency to contact the appropriate ATSU approaching, or over, the exit point; or

3) Instructions for the flight to contact the aeradio station serving the next CTA/FIR at a time or location prior the next CTA/FIR boundary or exit point.

E.7.2.1.1.6 During CPDLC operations, if a flight uses the term “C-P-D-L-C” after the aircraft call sign, the aeradio operator should:

- a) Advise the flight that “(type) FREQUENCIES WILL BE ASSIGNED VIA CPDLC”; or
- b) Issue:
 - 1) Communication instructions for the next CTA/FIR; or
 - 2) Communication instructions and the frequency to contact the appropriate ATSU approaching, or over, the exit point; or
 - 3) Instructions for the flight to contact the aeradio station serving the next CTA/FIR at a time or location prior to the next CTA/FIR boundary or exit point.

E.7.2.1.2 Aeradio - delayed CPDLC messages

E.7.2.1.2.1 If the flight crew advises “DELAYED CPDLC MESSAGE RECEIVED”, they are explaining that a CPDLC message was received late. Flight crew procedures require voice contact to verify the message status. Aeradio operators should include this notation when relaying the associated communication to ATC (see [paragraph 5.2.1.9](#) and [Appendix F, paragraph F.11](#) for flight crew procedures and [paragraph 3.1.2.6](#) for further information regarding delayed CPDLC uplinks).

E.7.3 Flight crew procedures

E.7.3.1 Voice communication procedures

E.7.3.1.1 Flight crew – contact with aeradio

E.7.3.1.1.1 The integrity of the ATC service remains wholly dependent on establishing and maintaining HF or VHF voice communications with each ATSU along the route of flight. The procedures in this section are applicable only in NAT airspace and pertain only to ATS data link operations.

E.7.3.1.1.2 Prior to entering each NAT oceanic CTA, the flight crew should contact the appropriate aeradio station.

E.7.3.1.1.3 [Table E-NAT- 5](#) provides the data link terms the flight crew should use to identify the flight. The flight crew should continue to use the data link term until either the SELCAL check has been completed or the frequency assignment has been received.

Table E-NAT- 5. Terms to identify data link capability

Term	Data link status of aircraft
“A-D-S”	Participating in ADS-C only.
“F-M-C”	Participating in FMC WPR
“C-P-D-L-C and A-D-S	Participating in CPDLC and ADS-C

E.7.3.1.1.4 If the flight will exit the CTA into oceanic and remote airspace, on initial contact with the CTA the flight crew should:

- a) Not include a position report;
- b) Use the appropriate data link term after the aircraft call sign (see [paragraph E.7.3.1.1.3](#));
- c) State the name of the next CTA/FIR to be entered; and
- d) Request the SELCAL check.

Example 1 (initial contact from an eastbound ADS-C-only flight about to enter the Gander CTA):

GANDER RADIO, AIRLINE 123 A-D-S, SHANWICK NEXT, REQUEST SELCAL CHECK CDAB.

Example 2 (initial contact from a westbound FMC WPR flight about to enter the Santa Maria CTA):

SANTA MARIA RADIO, AIRLINE 123 F-M-C, NEW YORK NEXT, REQUEST SELCAL CHECK AFMP.

Example 3 (initial contact from an eastbound CPDLC flight about to enter the New York Data Link service area):

NEW YORK ARINC, AIRLINE 123 C-P-D-L-C, GANDER NEXT, REQUEST SELCAL CHECK CKFM.

E.7.3.1.1.5 If the flight will exit the CTA into continental airspace, on initial contact with the CTA, the flight crew should:

- a) Not include a position report;
- b) Use the appropriate data link term after the aircraft call sign (see [paragraph E.7.3.1.1.3](#));
- c) State the track letter if operating on the organized track system;
- d) State the last two fixes in the cleared route of flight if operating outside the organized track system; and
- e) Request the SELCAL check.

Example 1 (initial contact from an eastbound ADS-C-only flight about to enter the Shanwick CTA):

SHANWICK RADIO, AIRLINE 123 A-D-S, TRACK ZULU, REQUEST SELCAL CHECK CDAB.

Example 2 (initial contact from a westbound CPDLC flight about to enter the Gander CTA):

GANDER RADIO, AIRLINE 123 C-P-D-L-C, SCROD VALIE, REQUEST SELCAL CHECK DMCS.

Example 3 (initial contact from an eastbound FMC WPR flight about to enter the Shanwick CTA):

SHANWICK RADIO, AIRLINE 123 F-M-C, TRACK ZULU, REQUEST SELCAL CHECK CDAB.

E.7.3.1.1.6 Depending on which data link services are offered in the CTA and the operational status of those services, the aeradio operator will provide appropriate information and instructions to the flight crew (see [paragraph E.7.2.1.1](#) for information regarding associated aeradio procedures).

E.7.3.1.1.7 In the event an onboard systems failure prevents CPDLC, ADS-C or FMC WPR or if any of these services is terminated:

- a) If the failure/termination occurs prior to initial contact with the aeradio station, do not use the phrase “A-D-S”, “C-P-D-L-C” or “F-M-C” after the aircraft call sign;
- b) Resume normal voice communications, including providing all subsequent position reports via voice;
- c) Do not inform aeradio that the service has been terminated; and

d) Inform Company Operations Department in accordance with established problem reporting procedures.

E.7.3.1.1.8 For ADS-C & FMC WPR flights, the flight crew should not submit position reports via voice to reduce frequency congestion, unless otherwise advised by aeradio operator.

E.7.3.1.1.9 ADS-C flights are exempt from all routine voice meteorological reporting, however the flight crew should use voice to report unusual meteorological conditions such as severe turbulence to the aeradio station.

E.7.3.1.1.10 The flight crew should not ask aeradio questions regarding the status of the ADS-C connections or whether an ADS-C or an FMC WPR has been received. Should the ATSU fail to receive an expected position report, the controller will follow guidelines in [paragraph 4.5.1.7](#) for late or missing ADS-C reports or request a voice report for a late or missing FMC waypoint position report.

E.7.3.1.1.11 When leaving CPDLC, ADS-C-only, or FMC WPR environment, the flight crew should comply with all communication requirements applicable to the airspace being entered.

E.7.3.1.1.12 If the flight crew does not receive its domestic frequency assignment by 10 minutes prior to the flight's entry into continental airspace, the flight crew should contact aeradio and request the frequency, stating the oceanic exit fix.

E.7.4 Advanced data link operations

NIL

E.7.5 State aircraft data link operation

NIL

E.8 Pacific (PAC) Region

E.8.1 Administrative provisions related to data link operations

E.8.1.1 ANSP service provision

Table E-PAC- 1. Data link services by control area (CTA).

Control area (CTA)	CPDLC	ADS-C	FMC WPR	AFN address	ATSU ACARS Address	Coord Group	Remarks
Anchorage and Anchorage Arctic (north of N63 and east of W165)	O	N	N	PAZA	ANCXFXA	IPACG FIT	CPDLC voice transfer: CONTACT PAZA CENTER [frequency] Confirm CPDLC CDA: One CPDLC position report at FIR boundary.
Anchorage Oceanic (south of N63 and west of W165)	O	O	N	PAZN	ANCATYA	IPACG FIT	CPDLC voice transfer: CONTACT PAZA CENTER [frequency] Confirm CPDLC CDA: One CPDLC position report at FIR boundary.
Auckland Oceanic	O	O	O	NZZO	AKLCDYA	ISPACG FIT	CPDLC voice transfer: MONITOR NZZO CENTER [frequency] SELCAL check by CPDLC equipped aircraft is not required on entering NZZO CTA. Aircraft filing a SELCAL code in FPL Item18 will be assumed to have serviceable SELCAL and be maintaining a SELCAL watch on the HF frequency advised in the monitor instruction passed by the transferring CPDLC authority. Confirm CPDLC CDA: One CPDLC position report at boundary.
Bangkok	O	O	O	VTBB	BKKGWXA	FIT BOB FIT SEA	Confirm CPDLC CDA: CPDLC <u>UM 160</u> (NDA).
Brisbane	O	O	T	YBBB	BNECAYA	ISPACG FIT	CPDLC voice transfer: MONITOR BRISBANE CENTER [frequency] Confirm CPDLC CDA: One CPDLC position report at FIR boundary.

Control area (CTA)	CPDLC	ADS-C	FMC WPR	AFN address	ATSU ACARS Address	Coord Group	Remarks
Chengdu (China)	O	O	N	ZUUU	CTUGWYA		
Chennai (India)	O	O	N	VOMF	MAACAYA	FIT BOB	
Delhi (India)	N	O	N	VIDF			
Fukuoka	O	O	N	RJJJ	FUKJJYA	IPACG FIT	CPDLC voice transfer: CONTACT TOKYO CENTER [frequency] Confirm CPDLC CDA: One CPDLC position report at boundary.
Honiara	O	O	N	YBBB	BNECAYA		
Kolkata (India)	O	O	N	VECF			
Kunming (China)	O	O	N	ZPPP	KMGGWYA		
Lanzhou (China)	O	O	N	ZLLL	LHWGWYA		
Mauritius	O	O	N	FIMM			Confirm CPDLC CDA: One CPDLC position report at boundary.
Melbourne	O	O	N	YMMM	MELCAYA	ISPACG FIT	CPDLC voice transfer: MONITOR MELBOURNE CENTER [frequency] Confirm CPDLC CDA: One CPDLC position report at boundary.
Mumbai (India)	O	O	N	VABF	BOMCAYA		
Nadi	O	O	N	NFFF	NANCDYA	ISPACG FIT	CPDLC voice transfer: MONITOR NFFF CENTER [frequency] Confirm CPDLC CDA: One CPDLC position report at boundary.
Nauru	O	O	N	YBBB	BNECAYA		MONITOR BRISBANE CENTER [frequency]

Control area (CTA)	CPDLC	ADS-C	FMC WPR	AFN address	ATSU ACARS Address	Coord Group	Remarks
Oakland	O	O	N	KZAK	OAKODYA	IPACG FIT ISPACG FIT	CPDLC voice transfer: CONTACT KSFO CENTER [frequency] Note.— KSFO (San Francisco Radio) will provide all primary and secondary HF frequencies, and HF transfer points along the route of flight. Confirm CPDLC CDA: One CPDLC position report at boundary.
Seychelles	O	O	N	FSSS			
Singapore	O	O	O	WSJC	SINCDYA	FIT SEA	Confirm CPDLC CDA: One CPDLC position report at boundary.
Tahiti	O	O	N	NTTT	PPTCDYA	ISPACG FIT	CPDLC voice transfer: CONTACT NTTT CENTER [frequency] Note.— A SELCAL check is required. Confirm CPDLC CDA: One CPDLC position report at boundary.
Ujung Pandang (Makassar) (Indonesia)	T	T	N	WAAF	UPGCAYA		Position reporting: CPDLC position report at each waypoint. Note.— Currently trialing ADS-C and CPDLC.
Ulan Bator (Mongolia)	O	O	N	ZMUA			
Urumqi (China)	O	O	N	ZWWW			
Colombo	T	T	N	VCCC			Position reporting: CPDLC position report at each waypoint. Note.— Currently trialing ADS-C and CPDLC. Primary communication via voice. Full HF reporting still required.
Yangon (Myanmar)	O	O	N	VYYF			

Table E-PAC- 2. Contact information

Coordinating group or regional monitoring agency	Contact information
TBD	TBD

Table E-PAC- 3. Regional monitoring agency websites available for problem reporting

Regional monitoring agency	Website URL
Informal South Pacific ATC Coordinating Group (ISPACG) and ISPACG Central Reporting Agency (CRA) and CRASA	http://www.ispacg-cra.com/

E.8.1.2 Exchange of turbulence information in Fukuoka FIR

E.8.1.2.1 In the Fukuoka FIR, the flight crew should report moderate or severe turbulence information. Turbulence information is provided for aircraft which fly around location of observation within height difference of $\pm 4,000$ feet from altitude of observation and will pass within two hours from time of observation.

E.8.1.2.2 The flight crew may use CPDLC for reporting and receiving moderate or severe turbulence information. For aircraft which does not have a CPDLC connection, the exchange of turbulence information is implemented by voice. The turbulence information provided to flight crews, whether by CPDLC or voice, will be the same.

E.8.1.2.3 Report of turbulence information by CPDLC

E.8.1.2.3.1 When reporting turbulence information via CPDLC, aircraft should downlink in the following form by free text message.

DM 67 [MOD or SEV] TURB [location of observation] [altitude of observation] [time of observation]Z

Note 1.— Aircraft should report location of observation in the following form. When observing turbulence continuously, aircraft is able to report location of observation in the following form; "[beginning location of observation] [end location of observation]".

- a) FIX (e.g. "NIPPI")
- b) Distance and radial from FIX (e.g. "20NM SW NIPPI")
- c) Latitude and longitude (e.g. "4020N14532E")
- d) When observing turbulence continuously (e.g. "RIPKI GARRY")

Note 2.— When observing turbulence while cruising, aircraft is able to report by omitting altitude of observation. When observing turbulence continuously while climbing or descending, aircraft should

report altitude of observation in the following form; "[lower limit altitude of observation] [upper limit altitude of observation]" (e.g. "FL330 FL350").

Note 3.— When reporting turbulence information within 5 minutes after observing, aircraft is able to report by omitting time of observation.

Examples of downlink messages:

"SEV TURB 35N160E FL330 0924Z"

"MOD TURB 20NM N ASEDA 35NM S ASEDA FL350 1152Z"

"MOD TURB NIPPI 2114Z"

"SEV TURB 3530N15451E FL370 FL390 0304Z"

"SEV TURB POXED FL320"

"MOD TURB CELIN"

E.8.1.2.4 Provision of turbulence information by CPDLC

E.8.1.2.4.1 When providing via CPDLC, turbulence information is uplinked in the following form by free text message:

UM 169 [MOD or SEV] TURB [location of observation] [altitude of observation] [time of observation]Z
[type of aircraft]

E.8.1.2.4.2 The downlink response **DM 3** ROGER should be used to acknowledge receipt of turbulence information issued.

Examples of uplink messages:

"MOD TURB NIPPI F360 0130Z B772"

"SEV TURB FM 37N160E TO 37N158E F320 0418Z A332"

"MOD TURB 20NM N ASEDA F330F350 1152Z B744"

E.8.2 Controller and radio operator procedures

NIL

E.8.3 Flight crew procedures

NIL

E.8.4 Advanced data link operations

NIL

E.8.5 State aircraft data link operation

NIL

E.9 South-America (SAM) Region**E.9.1 Administrative provisions related to data link operations****Table E-SAM- 1. Data link services by control area (CTA).**

Control area (CTA)	CPDLC	ADS-C	FMC WPR	AFN address	ATSU ACARS Address	Coord Group	Remarks
Atlantico (Brazil)	O	O	N	SBAO	RECOEYA		
Cayenne (French Guiana)	O	O	N	SOOO	CAYCAYA		<p>CPDLC voice transfer: MONITOR SOOO CENTER [frequency]</p> <p>SELCAL check by CPDLC equipped aircraft is not required on entering SOOO FIR. Aircraft filing a SELCAL code in FPL Item18 will be assumed to have serviceable SELCAL and be maintaining a SELCAL watch on the HF frequency advised in the monitor instruction passed by the transferring authority.</p> <p>Confirm CPDLC CDA: One CPDLC position report at SOOO boundary entry point.</p>
Rochambeau				SOOO			

E.9.2 Controller and radio operator procedures

NIL

E.9.3 Flight crew procedures

NIL

E.9.4 Advanced data link operations

NIL

E.9.5 State aircraft data link operation

NIL

Appendix F Operator/aircraft specific information

F.1 FANS 1/A and ATN B1 product availability

Remarks
FANS 1/A, FANS 1/A+ and ATN B1 packages are available on aircraft as listed below. The list is intended only to indicate availability of products on aircraft models. It does not indicate, for example: <ul style="list-style-type: none"> a) Actual equiptage and use; b) Capability to load route clearance information from CPDLC messages directly into an FMS; or <ul style="list-style-type: none"> c) Where FANS 1/A and ATN B1 are available on the same aircraft, that these aircraft support automatic CPDLC transfers.
Airbus A320
FANS A+ (CSB4) FANS A+ Data link Recording (CSB7) FANS B+ (CSB6) as ATN B1
Airbus A330, A340
FANS A (CLR3) FANS A+ (CLR4) FANS A+ Data link Recording (CLR7)
Airbus A380
FANS A+ Data link Recording (CLA3) FANS A+B (CLA4) as FANS 1/A-ATN B1
Airbus A350
FANS A+B (CLV1) as FANS 1/A-ATN B1
Boeing B747-400, 717, MD-90, MD-10, MD-11
FANS 1
Boeing B737, B757, B767
FANS 1+ (all) ATN B1 (without FANS 1)
Boeing B777, B787
FANS 1+ (all) FANS 2 (AIMS-2) as FANS 1+ and ATN B1
Boeing 747-8
FANS 2 as FANS 1+ and ATN B1

Dassault F900/F7X/F2000 EASy
FANS 1/A+ ATN B1 FANS 1/A-ATN B1
Dassault F900 retrofit
FANS 1/A+
Gulfstream GIV/GV
FANS 1/A+
Gulfstream G450/G550
FANS 1/A+ FANS 1/A-ATN B1
Gulfstream G650
FANS 1/A-ATN B1
Embraer Legacy G650
FANS 1/A
Embraer 170/190
ATN B1 FANS 1/A-ATN B1
Bombardier GEX/G5000
FANS 1/A+
Bombardier GlobalExpress6000
FANS 1/A+

F.2 Verifying aircraft registration

Airbus A380
On the A380 aircraft, the flight crew cannot change the aircraft registration in the FN_CON message. The aircraft registration is provided by the aircraft system.
Airbus A320, A330, A340
These aircraft do not have an <i>essential</i> data source for this datum, which means that the maintenance / flight crew needs to verify that the aircraft registration used for data link comm. is correct.
Boeing B787
On the B787 aircraft, the flight crew cannot change the aircraft registration in the FN_CON message. The aircraft registration is provided by the aircraft system.
Boeing B737, B747-400, B747-8, B777, B757, B767, B717, MD90, MD10, MD11
These aircraft do not have an <i>essential</i> data source for this datum, which means that the flight crew needs to verify that the aircraft registration is correct.

F.3 CPDLC connection management

Remarks
If the aircraft is establishing or in the process of establishing a connection with a previously designated next data authority, and a message with a new UM 160 NEXT DATA AUTHORITY [icao facility designation] message element is received, the aircraft sends DISCONNECT REQUEST (DR1) for this connection with the next data authority.
Airbus
If the facility designation in the new UM 160 NEXT DATA AUTHORITY is the same as the facility designation that the aircraft already retains, the aircraft discards the new UM 160 NEXT DATA AUTHORITY and the connections will not be affected.
Boeing
In the above case the connection will be terminated. The only CPDLC CR1 message processed normally by FANS 1 is the first CPDLC CR1 following a FN-CON (i.e. FN-CON was initiated when no CPDLC connection exists).

F.4 Flight crew display – response and acknowledgement

Airbus A320, A330, A340, A380			
On Airbus aircraft, the flight crew is offered a display prompt according to the following table.			
UM Attribute	Response	Flight Crew Responses	Flight Deck Display Prompt
W/U		WILCO, UNABLE, STANDBY	WILCO, UNABLE, STBY
A/N		AFFIRMATIVE, NEGATIVE, STANDBY	AFFIRM, NEGATV, STBY
R for FANS A/A+		ROGER, STANDBY	ROGER, STBY
R for ATN B1		ROGER, UNABLE, STANDBY	ROGER, UNABLE, STBY
Boeing			
On Boeing aircraft, the flight crew is offered a display prompt according to the following table.			
UM Attribute	Response	Flight Crew Responses	Flight Deck Display Prompt
W/U		WILCO, UNABLE, STANDBY	ACCEPT, REJECT, STANDBY
A/N		AFFIRMATIVE, NEGATIVE, STANDBY	ACCEPT, REJECT, STANDBY
R for FANS-1		ROGER, STANDBY	ACCEPT, STANDBY
R for ATN B1		ROGER, UNABLE, STANDBY	ACCEPT, REJECT, STANDBY
<p>a) When the flight crew selects either the ACCEPT or the REJECT prompt, the avionics automatically transmits the correct response (DM 0 WILCO, DM 3 ROGER, DM 4 AFFIRM, DM 1 UNABLE, or DM 5 NEGATIVE) for the corresponding message.</p> <p>b) On FANS 1 equipped aircraft, the flight crew cannot add any other element to a positive response.</p> <p>c) On some 747-400 airplanes with FANS-1, once the flight crew selects the ACCEPT or REJECT prompt, the VERIFY page displays DM 0 WILCO, DM 3 ROGER, or DM 1 UNABLE.</p>			

F.5 FMS processing of waypoints in position reports

Airbus A320, A330, A340, A380
The FMS cannot distinguish between ATC mandatory waypoints and waypoints inserted by the flight crew. However, the flight crew can over-write any system-determined default data contained in reports and confirm messages.
Boeing B747-400
The FMCs on the B747-400 aircraft does not distinguish between ATC mandatory waypoints and FMC sequenced waypoints for position reports. Additionally, the FANS 1 of the B747-400 aircraft does not permit the flight crew to overwrite the FMC-determined default “reported waypoint” position in downlink DM 45 - REPORTED WAYPOINT. However, the FANS 1 of the B747-400 aircraft does allow the flight crew to overwrite the FMC-determined default time (in particular, in response to uplink UM 138 -CONFIRM TIME OVER REPORTED WAYPOINT). Non-use of uplink UM 139 for B747-400 aircraft The uplink message UM 139 - Confirm reported waypoint should not be sent to B747-400 aircraft.
Boeing B737, B777, B757, B767, B717, MD90, MD10, MD11
The FMCs on these Boeing aircraft do not distinguish between ATC mandatory waypoints and FMC sequenced waypoints for position reports. However, the FANS 1 of these aircraft will allow the flight crew to overwrite the FMC-determined default “reported waypoint” position and time (Downlink element DM 45).
Boeing B787
The B787 FANS 1 can be selected to distinguish between ATC mandatory waypoints and non-mandatory waypoints for reporting the NEXT and NEXT+1 waypoints. However, the reported waypoint in a position report will always be the last sequenced waypoint, regardless of whether it is an ATC mandatory one. The FANS 1 will allow the flight crew to overwrite the FMC-determined default “reported waypoint” position and time (Downlink element DM 45).

F.6 Multiple request messages

Airbus A380
There is no network acknowledgement timer on A380 aircraft for the establishment of a connection. Once CPDLC is established, there is an ACK_DSP timer which is set as 3 min 30.
Airbus A320, A330, A340
There is no network acknowledgement timer on these Airbus aircraft for the establishment of a connection. Once CPDLC is established, there is an ACK_DSP timer which is set as follows: FANS A (CLR3) = 2 min FANS A+ (CLR4) = 3 min 30s FANS A+ DR (CLR7) = 6 min.

Boeing B747-400

If the network acknowledgement to a downlink message is not received by the B747-400 aircraft's ACARS Management Unit within a time period set in the Navigation Database or Operational Program Configuration (OPC) file, the FANS 1 closes the message and an alert is triggered to the flight crew. This alert may prompt the flight crew to re-send the message. Once back "IN COMM" the ACARS Management Unit will transmit any "queued" messages. The timer value is set to 5 minutes. If a second message is identical to the first, but with a different message identification number, and both messages have been received and responded to by the controller, the aircraft system will only recognize the message identification number of the second message. The aircraft system considers the first message to have been unsuccessful.

In reply to the controller's response to the first message, the aircraft system will send an INVALID REFERENCE NUMBER ERROR.

The controller's response to the second message will be processed normally.

In this case, if the controller ignores the first message, the connections to both ATS systems will not be lost when an End Service message is received on board the aircraft.

Boeing B737, B747-8, B757, B767, B717, MD90, MD10, MD11

When the network acknowledgement timer expires, it just "unlocks" the request pages, so that the flight crew will be able to send another one. The time at which the network acknowledgement timer expires can be set in the Operational Program Configuration (OPC) file in the FMS. Currently, the value is set to 5 minutes.

Boeing B777, B787

This network acknowledgement timer does not apply to these aircraft.

F.7 Waypoint sequencing**Airbus A320, A330, A340, A380**

Waypoint sequencing will only occur when the aircraft is within 7 NM of the aircraft active flight plan route (as modified by any parallel offset that may have been entered). Therefore ADS-C waypoint change event report and armed [UM 130](#) REPORT PASSING message will not be transmitted automatically when the aircraft is outside these limits.

Boeing B737, B747-400, B747-8, B757, B767, B777, B787, MD90

Waypoint sequencing will only occur when the aircraft is within 21 NM of the aircraft active flight plan route (as modified by any parallel offset that may have been entered). Therefore ADS-C waypoint change event report and armed [UM 130](#) REPORT PASSING message will not be transmitted automatically when the aircraft is outside these limits.

Boeing B717, MD10, MD11

Waypoint sequencing will only occur when the aircraft is within 7 NM of the aircraft active flight plan route (as modified by any parallel offset that may have been entered). Therefore ADS-C waypoint change event report and armed [UM 130](#) REPORT PASSING message will not be transmitted automatically when the aircraft is outside these limits.

F.8 Open uplinks at time of transfer of communications

Boeing
If there are OPEN uplinks in the ATC LOG when the CDA initiates transfer of communication to the Next Data Authority, the FMC will allow transfer to the Next Data Authority (i.e. the avionics will not disconnect the next data authority). This allows a smooth transfer to the next Flight Information Region if there are open uplinks at the time of transfer.
Airbus A330, A340 FANS A
If there are OPEN uplinks when the CDA initiates transfer of communication to the Next Data Authority, the avionics will disconnect all CPDLC connection.
Airbus A320, A330, A340, A380 FANS A+
If there are OPEN uplinks when the CDA initiates transfer of communication to the Next Data Authority, the avionics will allow transfer to the Next Data Authority (i.e. the avionics will not disconnect the next data authority). This allows a smooth transfer to the next Flight Information Region if there are open uplinks at the time of transfer.

F.9 Variable constraints

Airbus A320, A330, A340 FANS A & FANS A+
These Airbus aircraft do not support a <space> within a [unit name] parameter.
Airbus A320, A330, A340 and A380 FANS A+ Data Link Recording Airbus A320 FANS B+
Airbus A380 and A350 FANS A+B
These Airbus aircraft support a <space> within a [unit name] parameter.
Boeing
Boeing aircraft support a <space> within a [unit name] parameter.

F.10 ADS-C emergency report interval default

Airbus
If a periodic contract is active, the emergency reports will be transmitted at the existing periodic interval. Otherwise, the interval will default to 64 seconds.
Boeing
If a periodic contract is active, the emergency reports will be transmitted at the existing periodic interval. Otherwise, the interval will default to 304 seconds.

F.11 Message latency monitor

Remarks
For ATN B1 and FANS 1/A-ATN B1 aircraft, when a new ATN B1 CPDLC connection becomes active, this function is hard-coded in the avionics and is activated with a fixed value of 40 seconds (as per applicable standards).

Airbus

For FANS A+ and FANS A+B aircraft, when a new FANS 1/A CPDLC connection becomes active, this function automatically sets the [delayed message parameter] to the default NONE value (i.e. there is no check of a delayed CPDLC message until the flight crew manually sets a new value).

- a) It is possible the flight crew may activate the function by setting a value for the [delayed message parameter], even if not instructed to do so.
- b) If an ATSU is not using the message latency monitor and receives the above downlink, the following free text message may be sent: SET MAX UPLINK DELAY VALUE TO 999 SEC. This will minimize the possibility of subsequent uplink messages being rejected.

For all Airbus aircraft, the flight crew will not see delayed messages when the function is activated. Such a message is rejected, the ATSU will receive the following downlink message: INVALID DATA UPLINK DELAYED IN NETWORK AND REJECTED RESEND OR CONTACT BY VOICE. This message will refer to the delayed CPDLC uplink message.

Boeing (all except B747-400)

For most Boeing aircraft with a FANS-1+ connection, when a new active CPDLC connection is established, this function is automatically set to OFF with the following exceptions:

- a) Boeing aircraft, except B777 and B787, whose FANS 1/A+ CPDLC connection has been transferred will maintain the value of the [delayed message parameter], which was enabled during the previous CPDLC connection;
- b) Boeing 777 and 787 aircraft will maintain the value of the [delayed message parameter], which was enabled during any previous CPDLC connection, until the aircraft has landed at which time the value will be set to an operator-specified value in the aircraft's data base;
- c) It is possible the flight crew may set a value for the [delayed message parameter], even if not instructed to do so; and
- d) For aircraft with a FANS-1+ connection, the message is displayed to the flight crew with a delayed message indication.

F.12 Terminating ADS-C connections**Airbus**

For Airbus aircraft:

- a) FANS A+ – the flight crew has the capability to turn off the ADS-C application, which will terminate all ADS-C connections, or terminate a specific ADS-C connection.
- b) FANS A – the flight crew has the capability to turn off the ADS-C application, which will terminate all ADS-C connections.

Boeing B787

The flight crew has the capability to turn off the ADS-C application, which will terminate all ADS-C connections, or terminate a specific ADS-C connection.

Boeing B737, B747-400, B747-8, B777, B757, B767, B717, MD90, MD10, MD11

For these Boeing aircraft, the flight crew has the capability to turn off the ADS-C application, which will terminate all ADS-C connections.

F.13 SATCOM channel format

Airbus
The Frequencysatchannel parameter is defined as being a NumericString type having the values {space, 0, 1, 2, 3, 4, 5, 6, 7, 8, 9}.
Boeing
The Frequencysatchannel parameter is defined as being a NumericString type having the values {0, 1, 2, 3, 4, 5, 6, 7, 8, 9}.

F.14 Transfer of ATSU

Airbus FANS-A
Whenever an FN_CAD is sent by an ATSU A which does not use CPDLC towards a new ATSU B which uses CPDLC, FANS A Airbus a/c will reject any attempt from ATSU B to make a CPDLC connection (and will trigger a DR1), until the flight crew performs a manual logon with ATSU B.
Airbus FANS-A+
This limitation does not apply to Airbus FANS A+ aircraft.
Boeing
This limitation does not apply to Boeing aircraft.

F.15 Number of ADS-C connections

Airbus
Five ADS-C connections are available for ATS use.
Boeing B747-400
One of the ADS-C connections is reserved for operator use, and will only connect with the address specified in the aircraft's database. The other 4 connections may be used by ATSUs.
Boeing B737, B747-8, B777, B757, B767, B787, B717, MD90, MD10, MD11
Five connections are available for ATS use.

F.16 Lateral deviation events on offsets

Airbus
On all Airbus aircraft with FMS standards prior to Release 1A: When an offset is entered (or modified), the path from which lateral deviation is computed is immediately offset by the requisite distance. If a lateral deviation event contract is in place, and the deviation limit is less than the change in the offset, then an LDE report will be sent as soon as the offset is entered and executed.
On all Airbus aircraft with FMS Release 1A: When an offset is entered or modified, the FMS computes a path to fly to reach the new offset. Lateral deviation is the distance the aircraft is from this path, so entry of an offset does not affect the aircraft's lateral deviation, and no LDE report will be issued as a result of an offset entry.

Boeing B747-400, B747-8, B777, B757, B767, B717, MD90, MD10, MD11

When an offset is entered (or modified), the path from which lateral deviation is computed is immediately offset by the requisite distance. If a lateral deviation event contract is in place, and the deviation limit is less than the change in the offset, then an LDE report will be sent as soon as the offset is entered and executed.

Boeing B737, B787

When an offset is entered or modified, the FMS computes a path to fly to reach the new offset. Lateral deviation is the distance the aircraft is from this path, so entry of an offset does not affect the aircraft's lateral deviation, and no LDE report will be issued as a result of an offset entry

F.17 Assigned block altitude**Airbus**

Airbus aircraft can only respond to UM 135 CONFIRM ASSIGNED ALTITUDE with DM 38 ASSIGNED ALTITUDE [altitude], and not DM 77 ASSIGNED BLOCK [altitude] TO [altitude]. Assigned block levels will have to be reported with a free text message.

Boeing B777 AIMS-1

B777 aircraft with the AIMS-1 avionics (and those with AIMS-2 prior to Blockpoint v14) can only respond to UM 135 CONFIRM ASSIGNED ALTITUDE with DM 38 ASSIGNED ALTITUDE [altitude], and not DM 77 ASSIGNED BLOCK [altitude] TO [altitude]. Assigned block altitudes will have to be reported with a free text message.

Boeing B777 AIMS-2 and all other Boeing aircraft

Other Boeing aircraft (including B777 aircraft with AIMS-2 and Blockpoint v14 or later) can respond to UM 135 CONFIRM ASSIGNED ALTITUDE with either DM 38 ASSIGNED ALTITUDE [altitude], or DM 77 ASSIGNED BLOCK [altitude] TO [altitude].

F.18 FANS 1/A-ATN B1 aircraft behavior for automatic CPDLC transfers**Airbus, Boeing, Dassault F900/F7X/F2000 EASy, Gulfstream G650, Embraer 170/190**

FANS 1/A-ATN B1 aircraft have FANS 1/A+ and ATN B1 capability and comply with ED154A/DO305A. These aircraft benefit from automatic transfer between FANS 1/A and ATN B1 ATSU. They do not require any particular flight crew/controller procedures compared with ATN B1 and FANS 1/A aircraft.

Gulfstream G450/G550

Independent FANS 1/A-ATN B1 aircraft have FANS 1/A+ and ATN B1 capability but do not comply with ED154A/DO305A. Only one FANS 1/A+ or ATN B1 is active at a time. The flight crew must manually select either FANS 1/A+ or ATN B1 prior to logon. There is no automatic transfer between FANS 1/A and ATN B1 ATSU.

Dassault F900/F7X/F2000 EASy

Independent FANS 1/A-ATN B1 aircraft have FANS 1/A+ and ATN B1 capability but do not comply with ED154A/DO305A. Only one FANS 1/A+ or ATN B1 is active at a time. The flight crew must manually select either FANS 1/A+ or ATN B1 prior to logon. There is no automatic transfer between FANS 1/A and ATN B1 ATSU. ADS-C is only available when FANS 1/A+ is selected.

F.19 CM contact procedure

Remarks
ED110B/DO280B requires ATN B1 aircraft to send a successful CM Contact Response to a T-ATSU as soon as a Logon response was received from the R-ATSU, whatever the result (successful or not).
Airbus
FANS B+ and FANS A+B aircraft deviate from this requirement. FANS B+ and FANS A+B aircraft will send a successful CM Contact Response to the T-ATSU only if the Logon procedure with the R-ATSU succeeds. FANS B+ and FANS A+B aircraft will send a unsuccessful CM Contact Response to the T-ATSU : if the sending of the Logon Request to the R-ATSU fails, or if the no Logon Response is received in due time, or if the Logon response from the R-ATSU indicated failure.

F.20 Duplicate CPDLC uplink message processing

Airbus FANS A (CLR3), FANS A+ (CSB4/CLR4 & CLA3)
If a message is received that contains strictly identical coded data to any other pending (open) message, then it will be discarded as a duplicate, with no response to the ground, and no indication to the flight crew.
Airbus FANS A+ Data Link Recording (CSB7/CLR7), FANS A+B (CLA4 & CLV1)
If a message is received that contains strictly identical coded data to any other message, then it will be discarded as a duplicate, with no response to the ground, and no indication to the flight crew.
Boeing B747-400 (before Load 15), B757/B767 (before Peg03), B777 (before BP01), B737 (before U10.5), MD-90, B717, MD-10
If a duplicate message is received (e.g. the same message is received on both VHF and SATCOM), it will be treated like any other new message. If the existing message with the same MIN is still open (has not been responded/dispositioned by the flight crew) it will be rejected as a “duplicate MIN”.
Boeing B757/B767 (from Peg03), B777 (from BP01), B737 (from U10.5), B747-8, B787, MD-11
If a message is received that has the identical MIN and CRC to any other message in the log, then it will be discarded as a duplicate, with no response to the ground, and no indication to the flight crew.
Boeing B747-400 (from Load 15)
If a message is received that has the identical MIN and CRC to any other pending (open) message, then it will be discarded as a duplicate, with no response to the ground, and no indication to the flight crew.

F.21 Response to end-service and error uplink messages

Airbus

Boeing

When a FANS uplink containing a concatenated end-service (um161) and ERROR (um159), the flight crew will be presented with a display indicating a DOWNLINK ERROR.

While this construct is recommended in DO-258/ED-100, Section 4.6.2.2.2, it was not included in DO-219, which is the basis of FANS designs. ATC should therefore avoid using this type of concatenated message.

F.22 CPDLC connection after logon**Airbus****Boeing B747-400, B757, B767, B717, MD90, MD10, MD11 and B777 or B787 without FANS-2**

Once an AFN logon has been performed, the airplane will accept a CPDLC connection request (CR1) from any ATC Center. It is not required to be the center with which the AFN logon was performed.

Boeing B747-8, B777 and B787 with FANS-2

Once a CM or AFN logon has been performed, the airplane will accept a CPDLC connection request or CPDLC start from any center.

F.23 ARINC 424 oceanic waypoints**Remarks**

The Flight Management System on most airplanes will contain oceanic waypoints at whole degrees of latitude and longitude (and potentially at half degrees) with names assigned using the naming convention for such waypoints contained in ARINC 424.

Airbus**Boeing B747-400, B747-8, B777, B757, B767, B717, MD90, MD10, MD11**

If the route constructed by the flight crew or data linked from the airline contains such waypoints, then downlinked routes, position reports and requests for clearances (such as climbs or offsets) to start at a waypoint on the route will contain the ARINC 424 waypoint names.

Boeing B787

Whole-degree waypoints of this type in the route will be converted to the equivalent latitude/longitude for ATC downlinks.

F.24 STANDBY response to pilot-initiated downlink request**Airbus A320 & A330/A340 FANS A/A+**

A 5 minutes timer is set whenever the aircraft downlinks a CPDLC pilot-initiated request message.

If a STANDBY uplink response message is received by the aircraft within 5 minutes of the time the message was downlinked from the aircraft, the aircraft will accept any subsequent valid response message.

If no response message is received within 5 minutes of the time the message was downlinked from the aircraft, and if a STANDBY associated with the downlink message is received by the aircraft, any subsequent message associated with the downlink message is rejected by the aircraft without being displayed to the flight crew.

Airbus A380 FANS A+ Data link Recording and FANS A+B, Airbus A350 FANS A+B

Any valid uplink message responding to a CPDLC pilot-initiated request message is accepted as a response and displayed to the flight crew, whether a STANDBY was previously received or not.

Boeing

Any valid uplink message responding to a CPDLC pilot-initiated request message is accepted as a response and displayed to the flight crew, whether a STANDBY was previously received or not.

